



SURGICAL

INSTRUMENTS GUIDE

Surgical
Instruments
Catalogue



PAK K.T.S.
international

Manufacturer & exporter Surgical And Dental Instruments

SERVING THE HEALTH CARE INDUSTRY

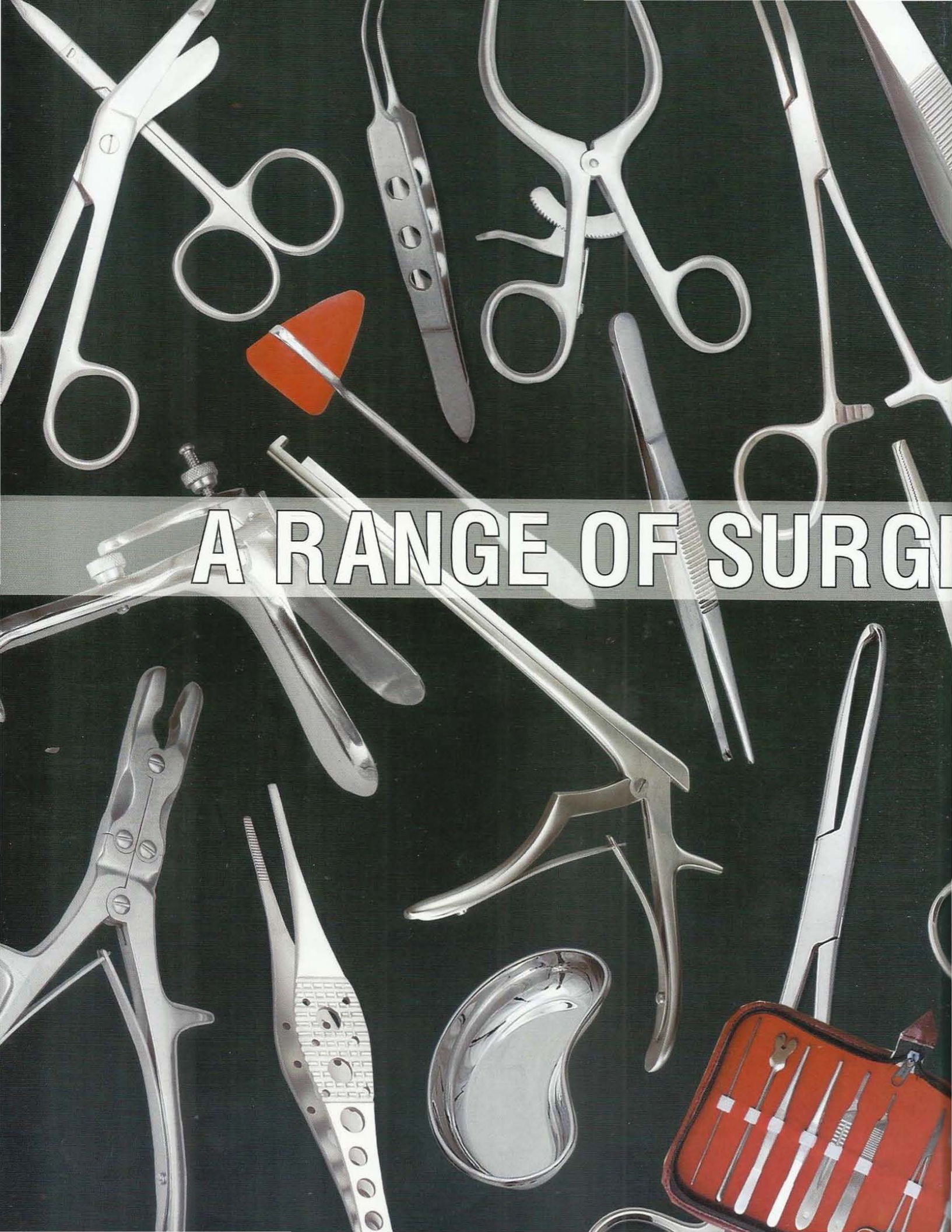

A RANGE OF SURGI

INSTRUMENTS CARE

First use of the products:

All instruments will be delivered "non sterilized" and must be cleaned and sterilized before use.

Cleaning & Disinfection:

The details given by the manufacturer of the solutions used for cleaning and disinfection regarding concentration, time and temperature must be observed exactly. Joints must be opened before manual cleaning or putting into detergent or cleaning with ultrasound. For the manual cleaning we recommend to use waterpistols, smooth tissues and tooth brushes. Do not use metal brushes!

Parts which can be taken apart must be cleaned separately! Moveable parts must be handled very carefully. After cleaning the parts have to be washed with distilled water and immediately after that they have to be totally dried.

Sterilization:

The packing is not autoclavable.

All parts can be sterilized in the autoclave. Plasmasterilisation of synthetic materials is not allowed, because those materials will be damaged. Please follow the details regarding loading and handling of the sterilisator given by the concerning manufacturer.

Check And Functional Gauging Each Use:

Cool down the products after sterilization before the functional gauging. Oil the joints with suitable physiologically harmless oil. Check the products after disinfection and cleaning with regards to cleanness and function. Products which are bended or damaged must be sorted out.

Storage & Indications:

The instruments should be stored dry - not in metal cases (excepting stainless steel or aluminum.) Direct sunlight should be avoided.

Handling:

The instruments are intended to be used in the surrounding conditions of medical rooms and should be used only by authorized medical personnel.

Handle the instruments always carefully. Take all necessary measures to avoid damaging of the instruments when transporting, cleaning, and storing them.

Do not contact the instruments with aggressive materials (such as acid, strong cleanser etc.)

The guarantee is max. 3 years

Improper use causes exclusion of all warranty rights.

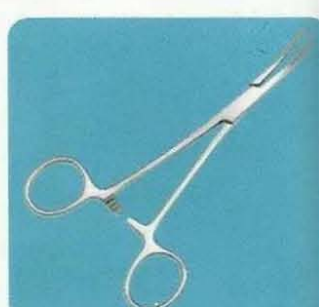
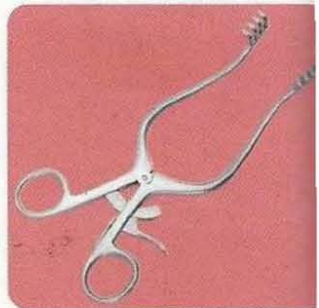
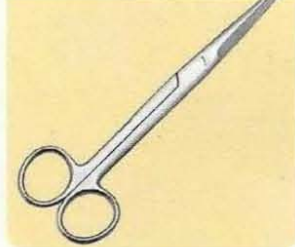

Quality Surgical Instruments

Quality Surgical Instruments

Quality Surgical Instruments



C
O
N
T
E
N
T
S

C O N T E N T S

Diagnostic, Anesthesia
Scalpels & Knives

05 06



PAGE 01 TO 22

SCISSORS



07

PAGE 23 TO 51

Forceps, Clamps

08 09 10



PAGE 52 TO 95

Needle Holders, Probes
Suture and Pocket Instruments



11

PAGE 96 TO 114

Hooks And Retractors

12



PAGE 115 TO 167

Forceps, Intestinal Clamp

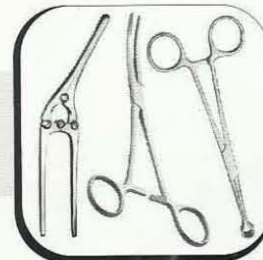

13

PAGE 168 TO 186

Biopsy Forceps

14

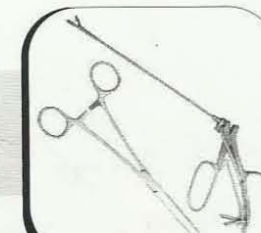

PAGE 187 TO 203

C O N T E N T S

Blader Retractors
Urinary Instruments & Trocars

15



PAGE 204 TO 208

Vaginal Specula &
Retractors



16

PAGE 209 TO 220

Utrine Dilators, Probes
Forceps, Myoma Inst.

17 18

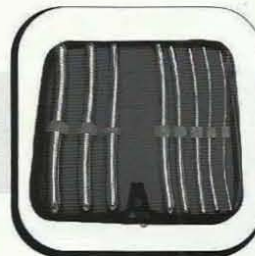

PAGE 221 TO 236

Biopsy Instruments

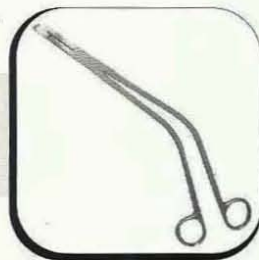

19

PAGE 237 TO 245

Obstertrics & Tracheotomy

20

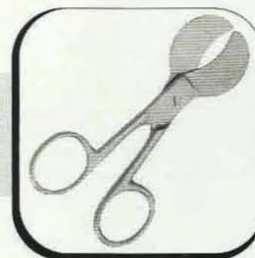

PAGE 246 TO 256

Cardiovascular & Thoracic
Surgery Instruments



21

PAGE 257 TO 309

Bone Punches & Rongeurs

22



PAGE 310 TO 318

C O N T E N T S

Amputation, Elevators, Bone
Files, Raspatories, & Curettes
Levers

23 **24**



PAGE 319 TO 347

Bone Rongeurs, Cutting, Holding Forceps,
Mallets, Tampers, Chisels, Gauges,
Meniscus Inst.



25 **26**

PAGE 348 TO 379

Wire Extension, Wire Cutting Plier,
Forceps & Finger Nail Instruments

27



PAGE 380 TO 392

Plaster Instruments

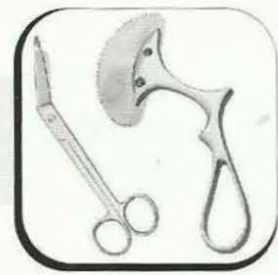

28

PAGE 393 TO 397

Suction Instruments
Sterilizing & Dissecting Set

29

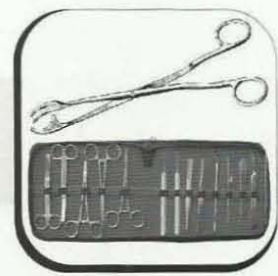

PAGE 398 TO 406

Tungsten Carbide
Instruments

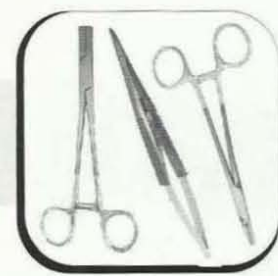

30

PAGE 407 TO 413

Hospital Wares

31



PAGE 414 TO 424

	SECTION	PAGE
Diagnostic, Anaesthesia, Scalpals & Knives	5/6	1-22



Percussion Hammers & Aesthesiometers



05-101 A
Spare Rubber
Large For 05-101



05-101 B
Spare Rubber
Small For 05-101



05-102
DEJERINE
Size: 200 mm

1/2



1/2

05-103
DEJERINE
With Needle
Size: 210 mm



05-104
TAYLOR
Size: 195 mm

1/2



1/2

05-101
TROEMNER
Size: 245 mm



1/2

05-105
BERLINER
Size: 200 mm



05-106 A
Spare Rubber
Large For 05-106

05-106 B
Spare Rubber
Small For 05-106



1/2

05-106
BUCK
With Needle
And Brush
Size: 180 mm



1/2

05-107
RABINER
With Needle
And Brush
Size: 255 mm



1/2

05-108
ALY
Size: 190 mm



1/2

05-109
WARTENBERG
Pinwheel For
Neurological
Examination
Size: 185 mm

For Fetal Heart Sounds



PINARD
05-110
 With detachable base
05-110A
 With fixed base
 15.5 cm / 6"
 Aluminium



05-111
 aus Holz
 Wooden
 Size: 145 mm



05-111 T
 TUNING FORKS

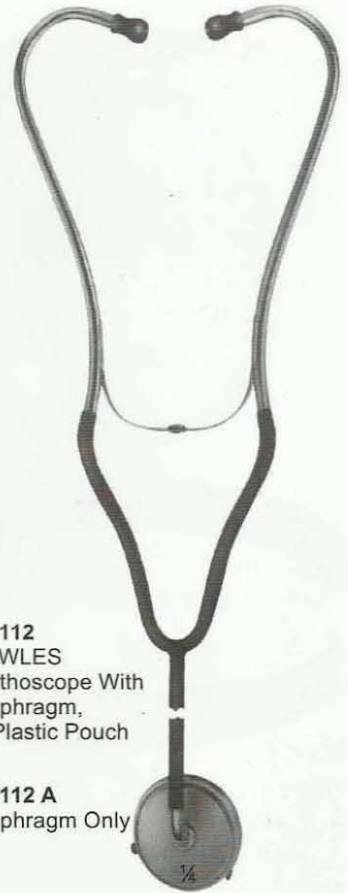

05-112
BOWLES
 Stethoscope With
 Diaphragm,
 In Plastic Pouch

05-112 A
 Diaphragm Only



05-113
ANESTOPHON
 Ø47mm



05-114
FORD-BOWLES
 Combination Stethoscope
 With Diaphragm and Bell



05-114 A
 Dual Chest Piece
 With Two Outlets

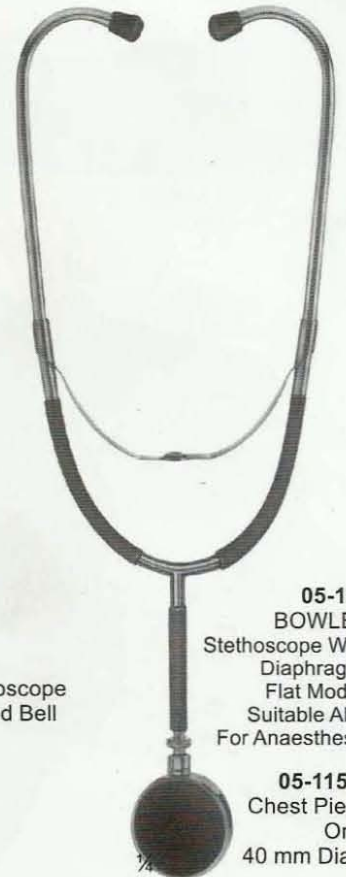

05-115
BOWLES
 Stethoscope With
 Diaphragm,
 Flat Model,
 Suitable Also
 For Anaesthesia

05-115 A
 Chest Piece
 Only
 40 mm Diam

**HEAD MIRRORS, HEAD BANDS &
Blood Pressure Manometers**

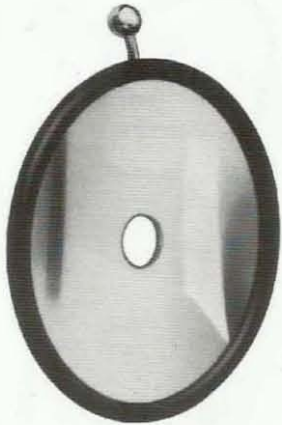

05-116
ZIEGLER Ø 90mm
Head mirror only
with rubber coating

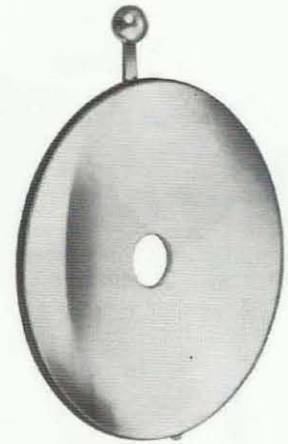

05-117
ZIEGLER Ø 90mm
Head mirror only
with metal coating



05-118
ZIEGLER
Head band of plastic, black only
05-119
ZIEGLER
Head band of plastic, white only



05-120
MURPHY
Head band of celluloid, white only

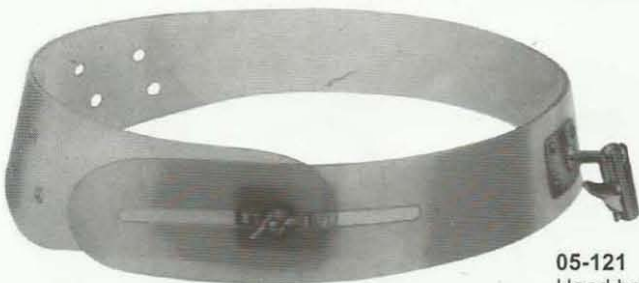

05-121
Head band of plastic,
white, soft pattern



05-122
Head mirror (05-116)
with black plastic head
band (05-118)



05-122A
Calibrated with velcro cuff, in bag
with manometer

05-122B
Non calibrated with velcro cuff, in bag
with manometer

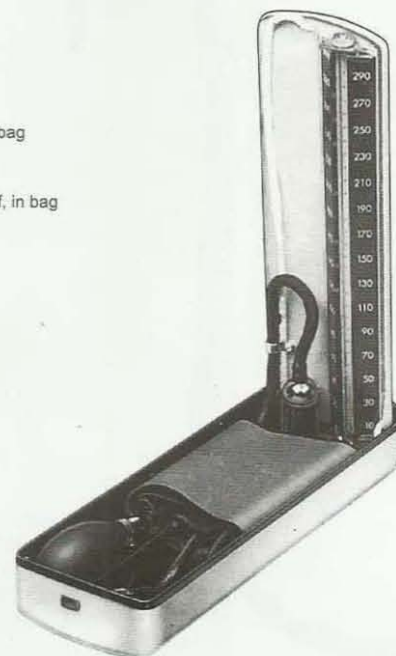

05-122C
Calibrated with velcro cuff
mercury tube 300 mm,
also available with auto lock

05-122D
Non calibrated with velcro cuff
mercury tube 300 mm,
also available with auto lock

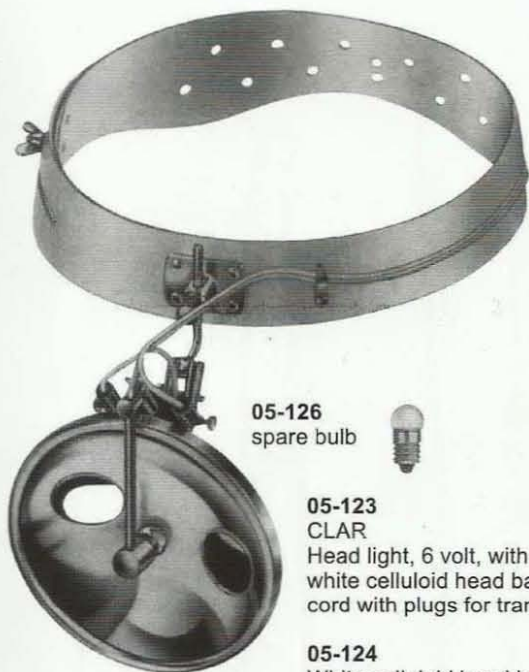

05-126
spare bulb

05-123
CLAR
Head light, 6 volt, with adjustable joint, white celluloid head band, cord with plugs for transformer 04-05-139 and 140

05-124
White celluloid head band, only, for 04-05-123

05-125
Spare mirror only, for 04-05-123



05-131
spare bulb

05-127
CLAR
Head light, 6 volt, with adjustable joint, white celluloid head band, with foam rubber pad and cord with plugs for transformer 05-139 and 140

05-128
White celluloid head band, only, for head light 05-127

05-129
mirror only, for head light 05-127

05-130
spare foam rubber pad, for head band 05-128



05-133
spare bulb

05-132
JANSEN
Head light, 6 volt, with adjustable joint, white plastic head band, cord with plugs for transformer 05-139 and 140



05-135
spare bulb

05-134
LANGENBECK
Head light, 3.7 volt, with adjustable joint, white plastic head band, cord with plugs for transformer 05-139 and 140



05-136
HERBERHOLD
Pocket-Accu, 6 volts, with cord 05-137 for head lights
05-132 **05-123** **05-127**



05-137
Extension cord only, to connect the accu to the cord of the head lights
05-132 **05-123** **05-127**



05-138
Charging Set for pocket accu **05-136**
mains current: 220-240 volts, 50-60 Hz



05-139
220 volt / 220 volts
05-140
120 volt / 120 volts
Transformer

Tongue Depressors, Retractors

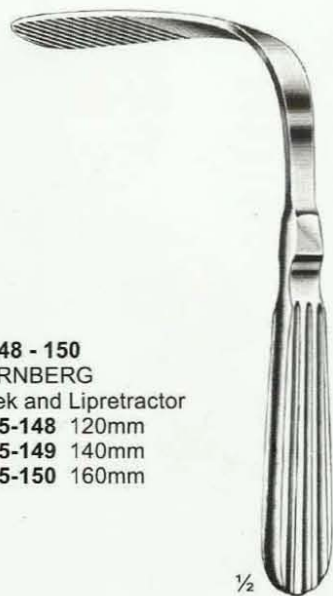
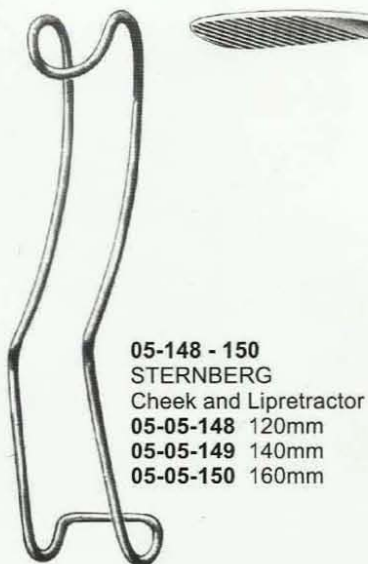
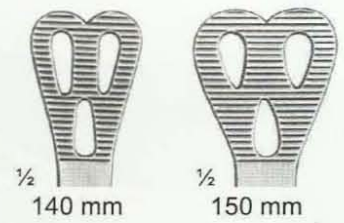
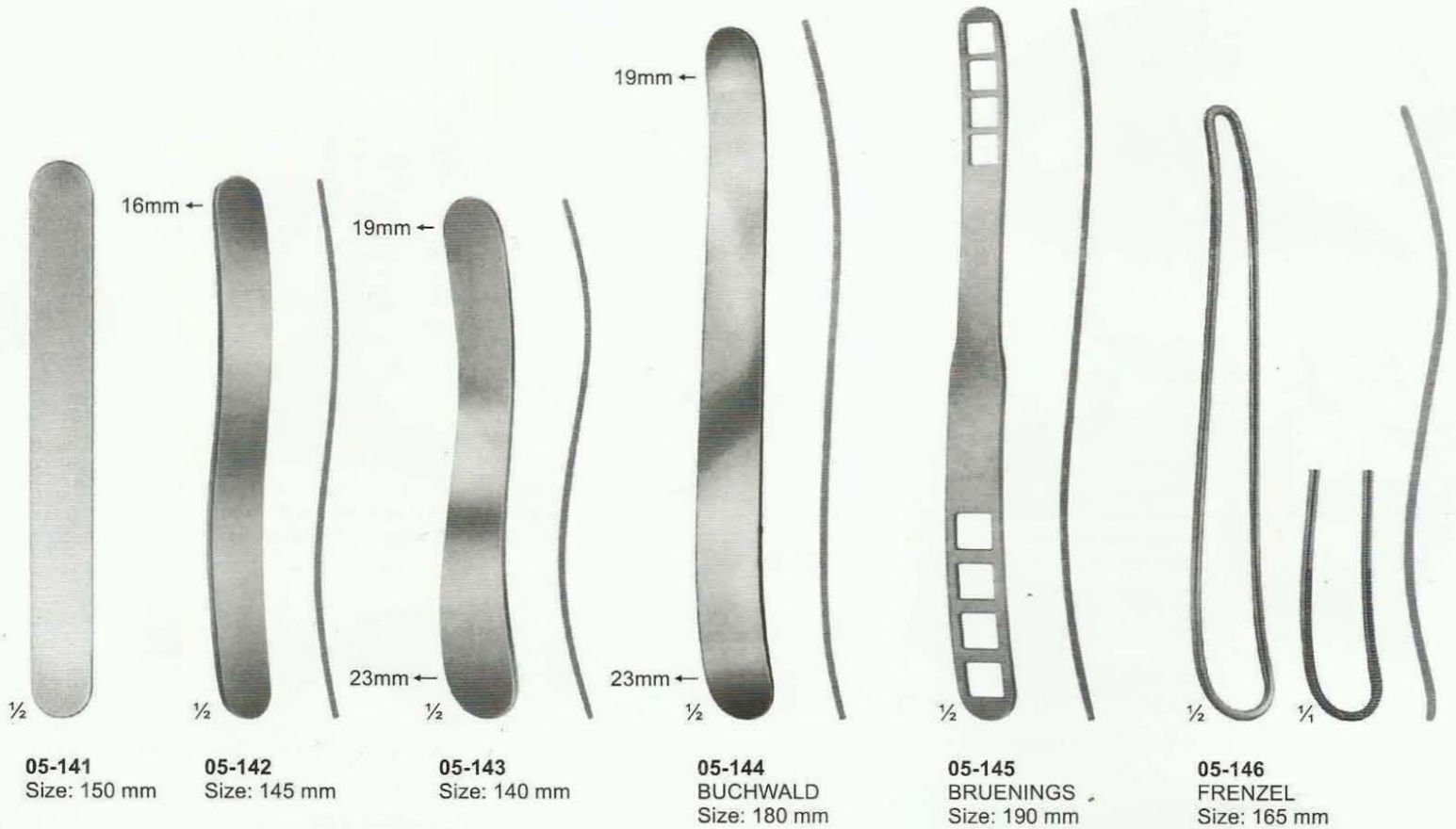



05-155
SCHIMMELBUSCH
Ether Mask



05-156
HEISTER
Mouth Gag
Size: 130 mm



05-157
FERGUSSON-ACKLAND
Mouth Gag
Size: 145 mm



05-158
DENHARDT
Mouth Gag With
Silicon Inserts,
Interchangeable
Size: 125 mm

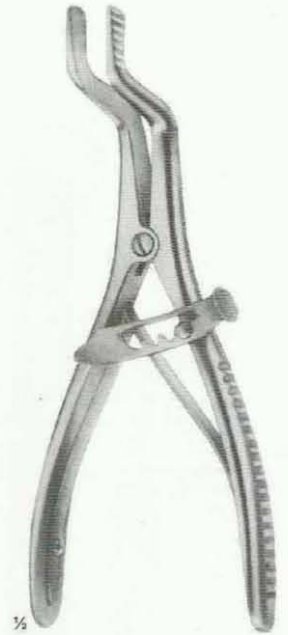

05-159-160
ROSER KOENIG
Mouth Gag
Size: 05-159 160mm
05-160 185mm



05-161
YOUNG
Size: 165 mm



05-162
1 Pair Of
Rubber Pads
For 05-161



05-163 - 164
COLLIN



05-163
Size: 160 mm



05-164
Size: 170 mm

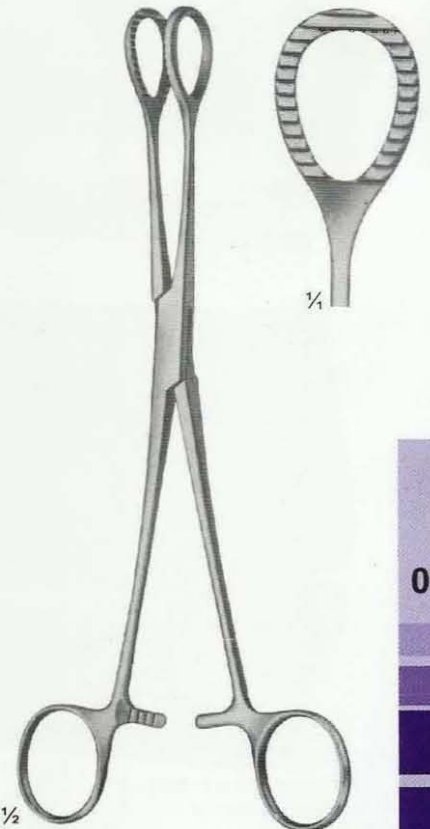

05-165
HEYWOOD-SMITH modif.
Size: 215 mm

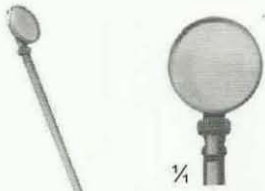

1/4
05-166
Ø 12 mm

05-168
Spare Mirrors Only



1/4
05-167
Ø 14 mm

05-168 A
Spare Mirrors Only

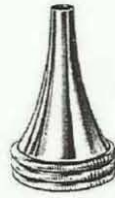

Hartmann
05-168B
Set of 5

- Fig. 1 3 mm Ø
- Fig. 2 4 mm Ø
- Fig. 3 5 mm Ø
- Fig. 4 6 mm Ø
- Fig. 5 7 mm Ø



Gruber
05-168C Round
05-168D Oval
Set of 3

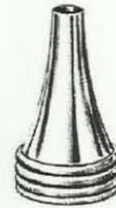

Toynbee
05-168E
Set of 5



- Fig. 1 5.5 x 6.5 mm
- Fig. 2 6.5 x 7.5 mm
- Fig. 3 7.5 x 8.5 mm
- Fig. 4 8.5 x 9.5 mm
- Fig. 5 9.5 x 10.5 mm
- Fig. 6 10.5 x 11.5 mm

Zollner
05-168F
3.8 cm
Set of 6 pieces
Oval, Black



- Fig. 1 5.5 mm
- Fig. 2 6.5 mm
- Fig. 3 7.5 mm
- Fig. 4 8.5 mm
- Fig. 5 9.5 mm
- Fig. 6 10.5 mm
- Fig. 7 11.5 mm

05-168G
Farrior
3.6 cm
Black



1/2
05-166
MICHEL
Rhinoscopic Mirrors
With Interchangeable
Mirror Inserts
Size: 250 mm



1/2
05-169
Mirror Handle
Size: 110 mm



1/2
05-170
Mirror Handle
Size: 105 mm



1/2
05-171
FRANCKE
Automatic
Blood Lancet



05-172
KOLLE
Microscopic
Needle Holder
With Plastic
Handle
Size: 240 mm



Fig. 000
Ø 6mm
05-173



Fig. 00
Ø 8mm
05-173 A



Fig. 0
Ø 10mm
05-173 B



Fig. 1
Ø 12mm
05-173 C



Fig. 2
Ø 14mm
05-173 D



Fig. 3
Ø 16mm
05-173 E



Fig. 4
Ø 18mm
05-173 F

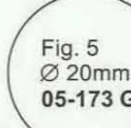

Fig. 5
Ø 20mm
05-173 G

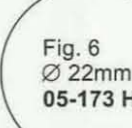

Fig. 6
Ø 22mm
05-173 H



Fig. 7
Ø 24mm
05-173 I



Fig. 8
Ø 26mm
05-173 J



Fig. 9
Ø 28mm
05-173 K

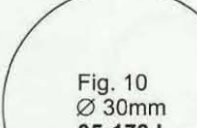

Fig. 10
Ø 30mm
05-173 L

1/2
05-173-173 L
Laryngeal Mirrors With
Hexagonal Handle
Size: 180 mm



05-174
Infants
Size: 150 mm



05-175
Children
Size: 200 mm



05-176
Adults
Size: 250 mm

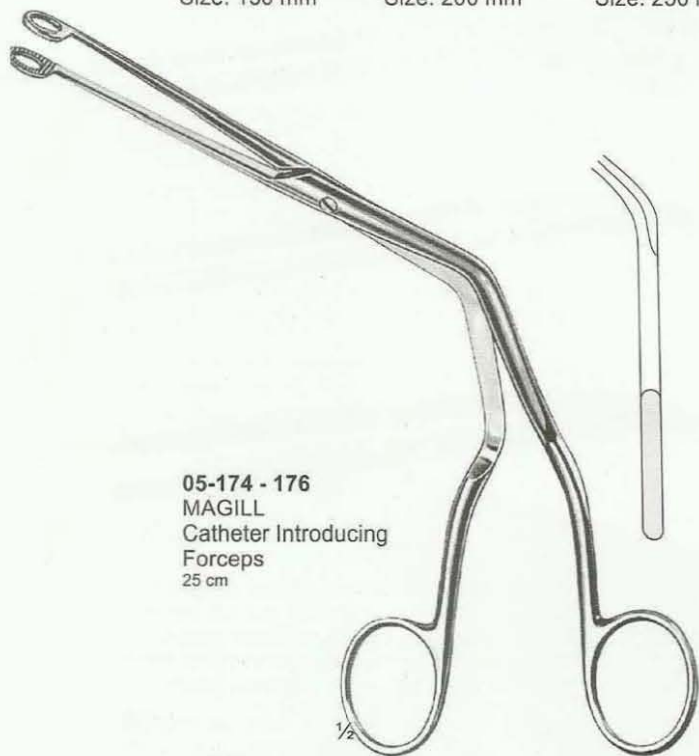

05-174 - 176
MAGILL
Catheter Introducing
Forceps
25 cm



1/2



05-179
Spare bulb
2.7 volt, for
Otoscopes etc.



05-179A
Spare bulb
2.6 volt, for
ophthalmoscopes



05-179B
Spare bulb
2.6 volt, for
ophthalmoscopes



05-177
Otoscope



05-178
ophthalmoscopes

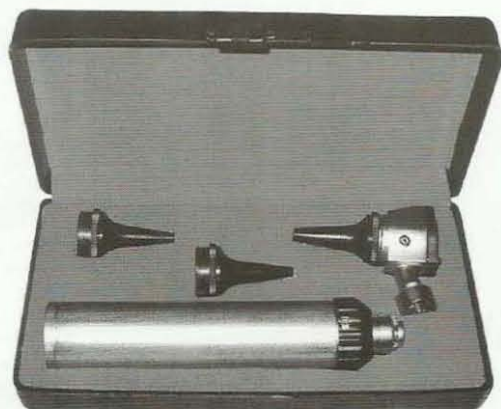

05-180
Otoscope Set, Consists Of
Battery Handle Without Batteries,
3 Ear Specula, 1 Bulb In Valvet Lined Case



05-181
Diagnostic Set, Otoscope With Three Specula,
Nasal Speculum, Lamp Holder, Two Laryngeal
Mirrors, Tongue Blade Holder

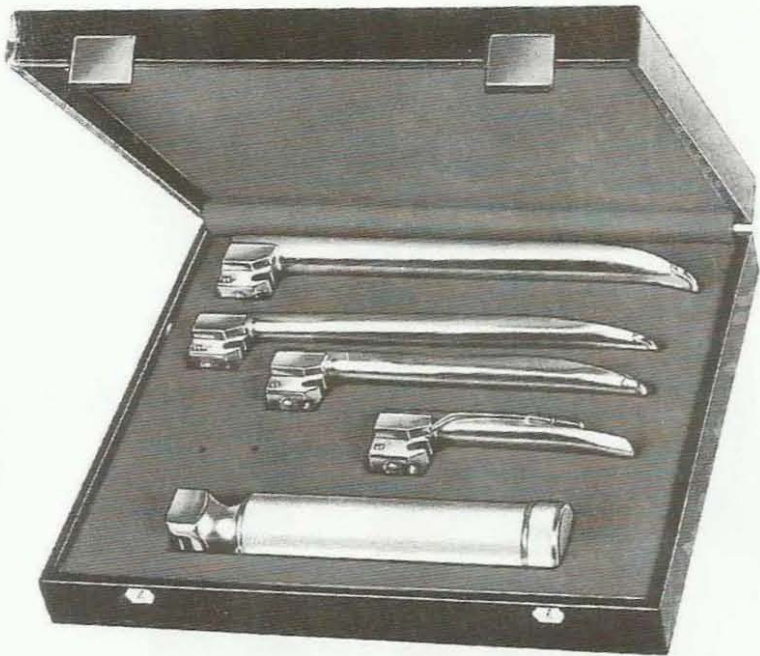

05-182
MILLER
 Laryngoscope Set, Consists Of Battery Handle (Without Battery)
 With Four Miller Laryngoscope Blades, Fig 1 to 4
05-182F
 Fiber optic Laryngoscope set with medium handle
 Set of 4



Fig. 0



Fig. 1

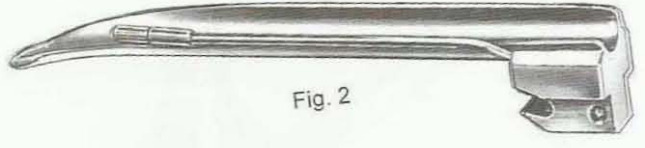

Fig. 2

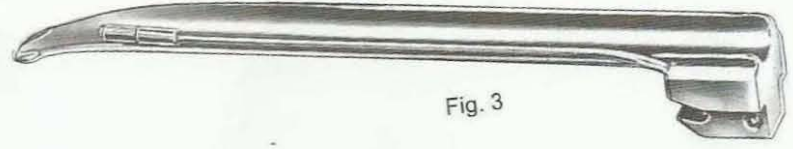

Fig. 3

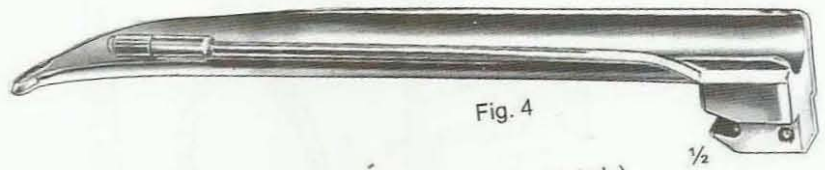

Fig. 4

05-182 A Fig. 0 Working Length, 55 mm (Baby's)
 05-182 B Fig. 1 Working Length, 80 mm (Children's)
 05-182 C Fig. 2 Working Length, 130 mm (Adolescent's)
 05-182 D Fig. 3 Working Length, 170 mm (Women's)
 05-182 E Fig. 4 Working Length, 180 mm (Men's)



05-183
GUEDEL-NEGUS
 Laryngoscope Set, Consists Of Battery Handle (Without Battery)
 With Four Miller Laryngoscope Blades
05-183F
 Fiber optic Laryngoscope set with medium handle

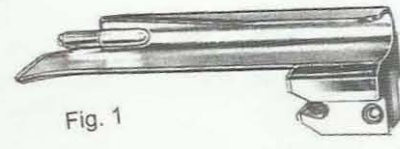

Fig. 1



Fig. 2

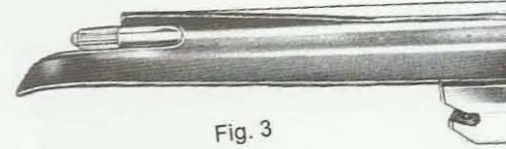

Fig. 3

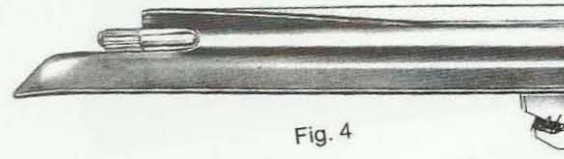
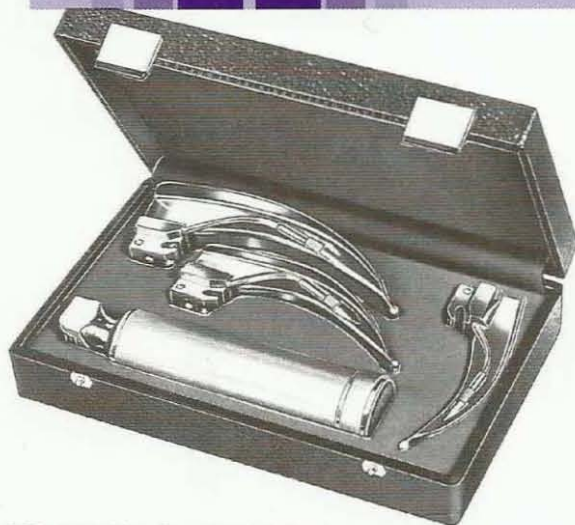

Fig. 4

05-183 A Fig. 1 Working Length, 70 mm (Children's)
 05-183 B Fig. 2 Working Length, 90 mm (Adolescent's)
 05-183 C Fig. 3 Working Length, 110 mm (Women's)
 05-183 D Fig. 4 Working Length, 135 mm (Men's)



05-184
McINTOSH
 Laryngoscope Set, Consists Of Battery Handle (Without Battery)
 With Three McIntosh Blades, Fig. 1, Fig. 2, Fig. 3

05-184F
 Fiber optic laryngoscope set with medium handle (Without Battery)
 With Three McIntosh Blades, Fig. 1, Fig. 2, Fig. 3

05-185
McINTOSH
 Laryngoscope Set, Consists Of Battery Handle (Without Battery)
 With Five McIntosh Blades, Fig. 0, Fig. 1, Fig. 2, Fig. 3, Fig. 4

05-185F
 Fiber optic laryngoscope set with medium handle (Without Battery)
 With Three McIntosh Blades, Fig. 1, Fig. 2, Fig. 3

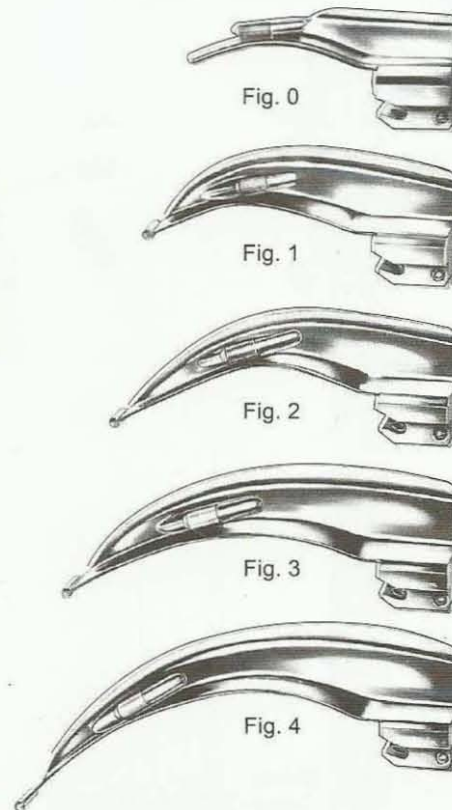

05-185 A Fig. 0 Working Length, 55 mm (Baby's)
 05-185 B Fig. 1 Working Length, 75 mm (Children's)
 05-185 C Fig. 2 Working Length, 90 mm (Adolescent's)
 05-185 D Fig. 3 Working Length, 110 mm (Women's)
 05-185 E Fig. 4 Working Length, 135 mm (Men's)



05-186
FOREGGER
 Laryngoscope Set, Consists Of
 Battery Handle (Without Battery)
 With Three Foregger Blades,
 Fig. 1, Fig. 2, Fig. 3,

05-187
FOREGGER
 Laryngoscope Set, Consists Of
 Battery Handle (Without Battery)
 With Four Foregger Blades,
 Fig. 1, Fig. 2, Fig. 3, Fig. 4,

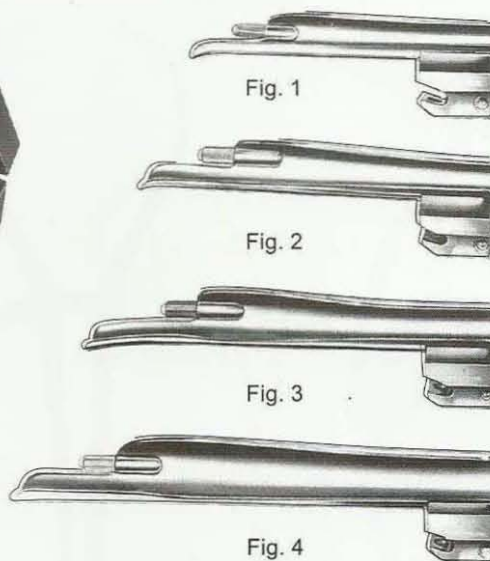

05-186 A Fig. 1 Working Length, 70 mm (Children's)
 05-186 B Fig. 2 Working Length, 90 mm (Adolescent's)
 05-186 C Fig. 3 Working Length, 110 mm (Women's)
 05-186 D Fig. 4 Working Length, 135 mm (Men's)



05-188
 Spare small handle
 Conventional



05-189
 Spare medium handle
 Conventional



05-189A
 Spare large handle
 Conventional

05-188F
 Spare small handle
 Fiber optic

05-189F
 Spare medium handle
 Fiber optic

05-189AF
 Spare large handle
 Fiber optic



05-190
 Replacement Lamp
 (Krypton) 2.5 V



05-191
 Replacement Lamp
 (Halogen) 2.5 V

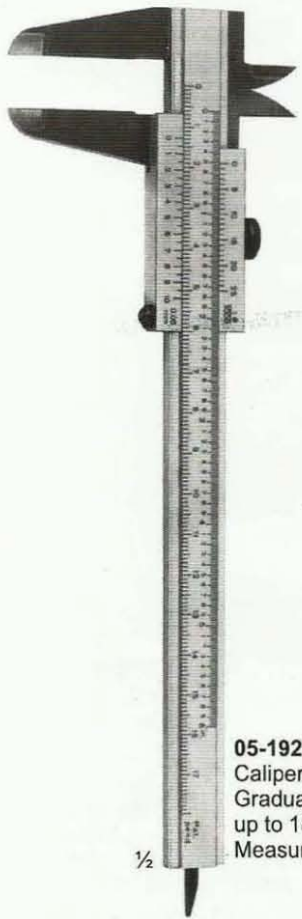

05-192
Caliper Of Aluminium
Graduated in mm & inches
up to 180mm
Measuring Range up to 139mm

1/2

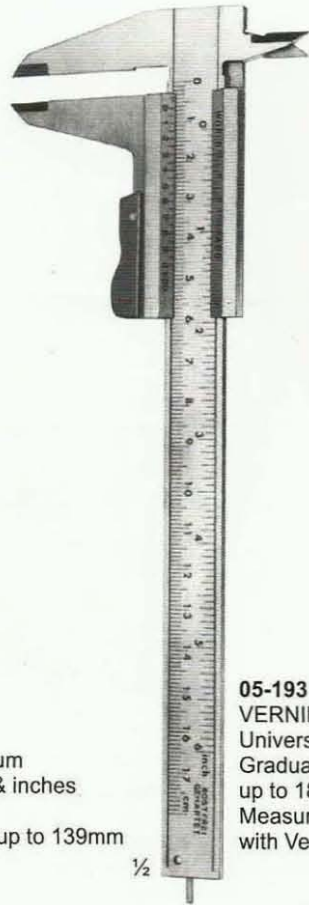

05-193
VERNIER
Universal Caliper Of Steel
Graduated in mm & inches
up to 180mm
Measuring Range up to 120mm
with Vernier in 1/10mm & 1/16"

1/2



05-194
CARROLL
Size: 145 mm
Finger Goniometer

1/2



05-195
TOWNLEY
Graduated in
mm & inches
Size: 115 mm

1/2

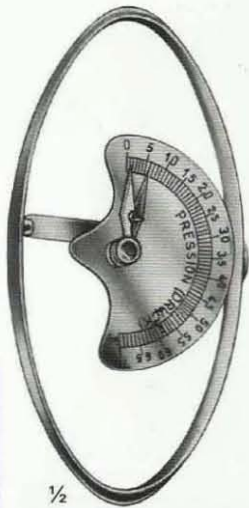

1/2

05-196
COLLIN
Druck Pressure 72 kg
Size: 125 mm

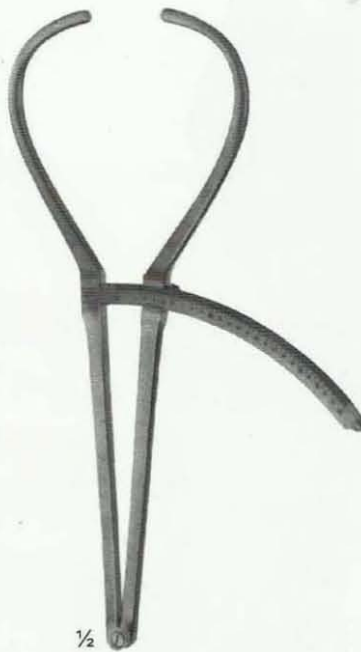

1/2

05-197
BERTILLON
Caliper For Measuring The Head
Size: 320 mm



1/4

05-198
CASTROVIEJO
Caliper
Size: 75mm

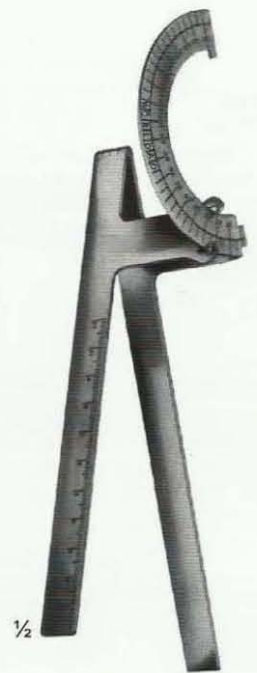

1/2

05-199
MOLTGEN
Goniometer

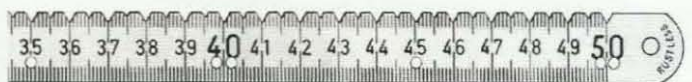
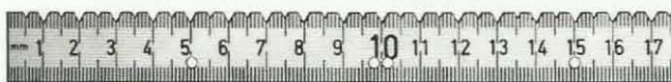

05-201
Size: 150 mm

05-200
Size: 500 mm



06-101 - 110
Fig. 1 - 10
With Metal Handle



06-101
Fig. 1
Size: 30mm
15cm

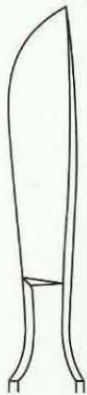

06-102
Fig. 2
Size: 36mm
15cm

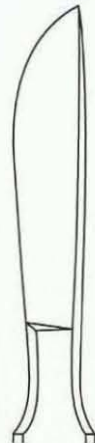

06-103
Fig. 3
Size: 40mm
15.5cm



06-104
Fig. 4
Size: 45mm
16cm

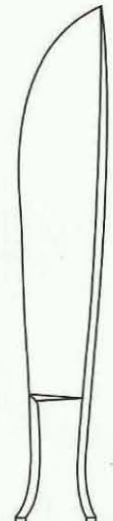

06-105
Fig. 5
Size: 50mm
16cm



06-106
Fig. 6
Size: 27mm
15cm



06-107
Fig. 7
Size: 35mm
15cm

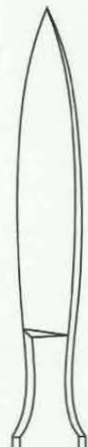

06-108
Fig. 8
Size: 40mm
16cm



06-109
Fig. 9
Size: 47mm
16cm



06-110
Fig. 10
Size: 50mm
17cm

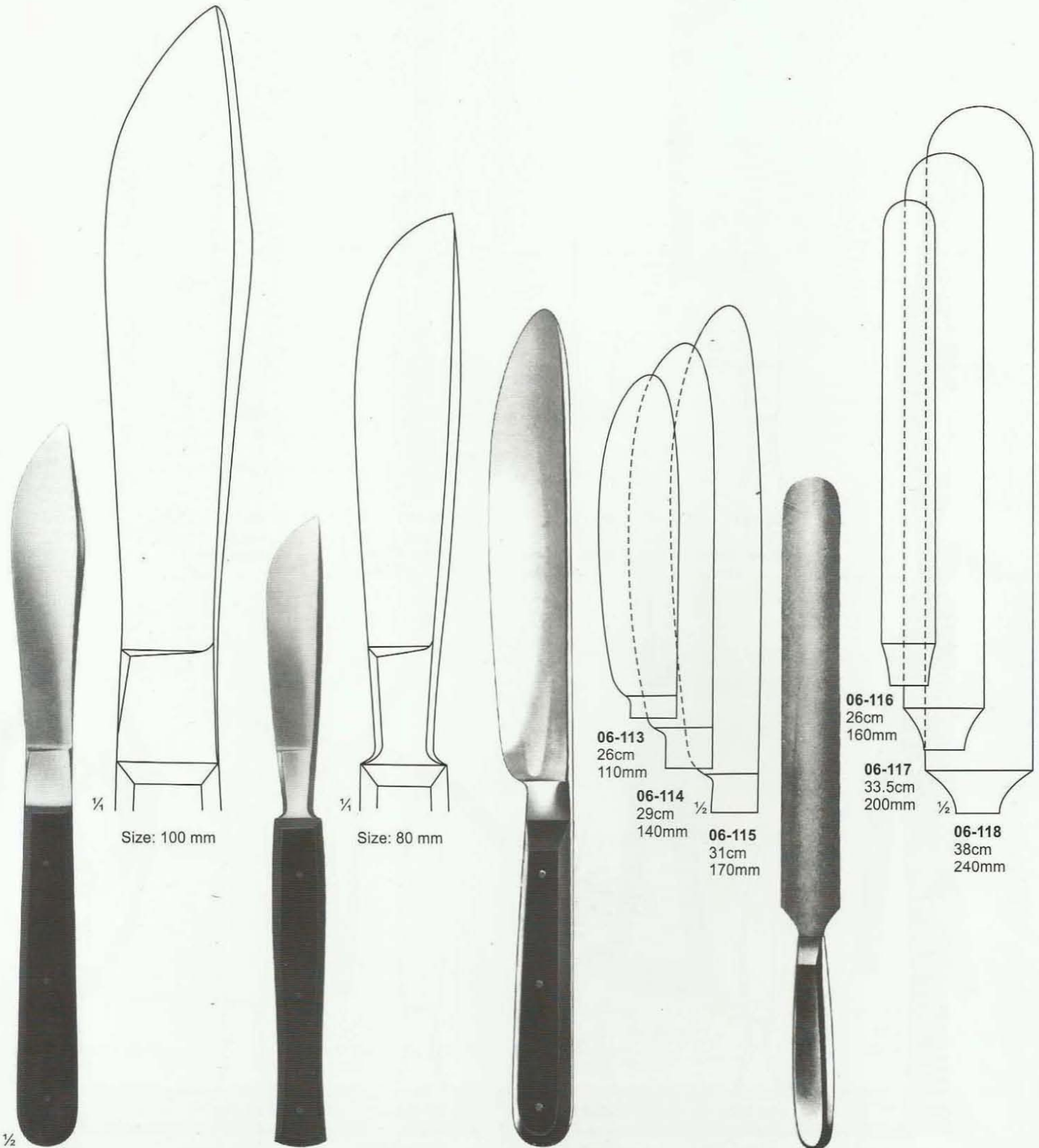

13-06-111
Size: 255 mm
wooden handle.

13-06-112
210mm
with wooden handle

13-06-113 - 115
WALB
with wooden handle

13-06-116 - 118
VIRCHOW
with hollow handle

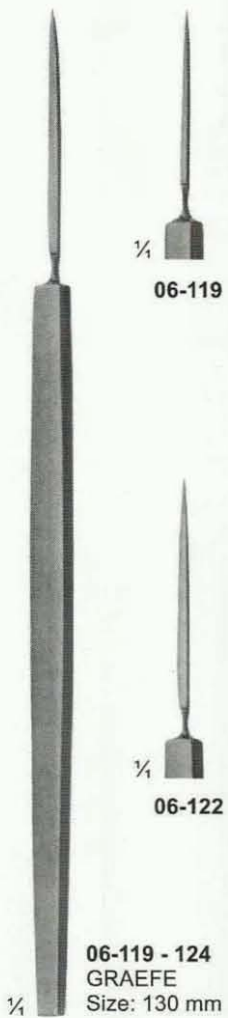

06-119 - 124
GRAEFE
Size: 130 mm



06-119



06-120



06-121



06-122



06-123



06-124



06-125 - 126
DIEFFENBACH
Size: 160 mm



06-125



06-126
Tenotome



06-127
Size: 290 mm



06-128
Size: 180 mm
Langenbeck
Length of Blade
55 mm

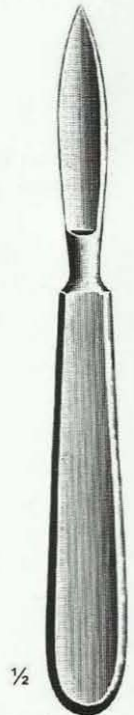

06-129
Size: 180 mm
Langenbeck
Length of Blade
55 mm

SCALPELS, TENOTOMES

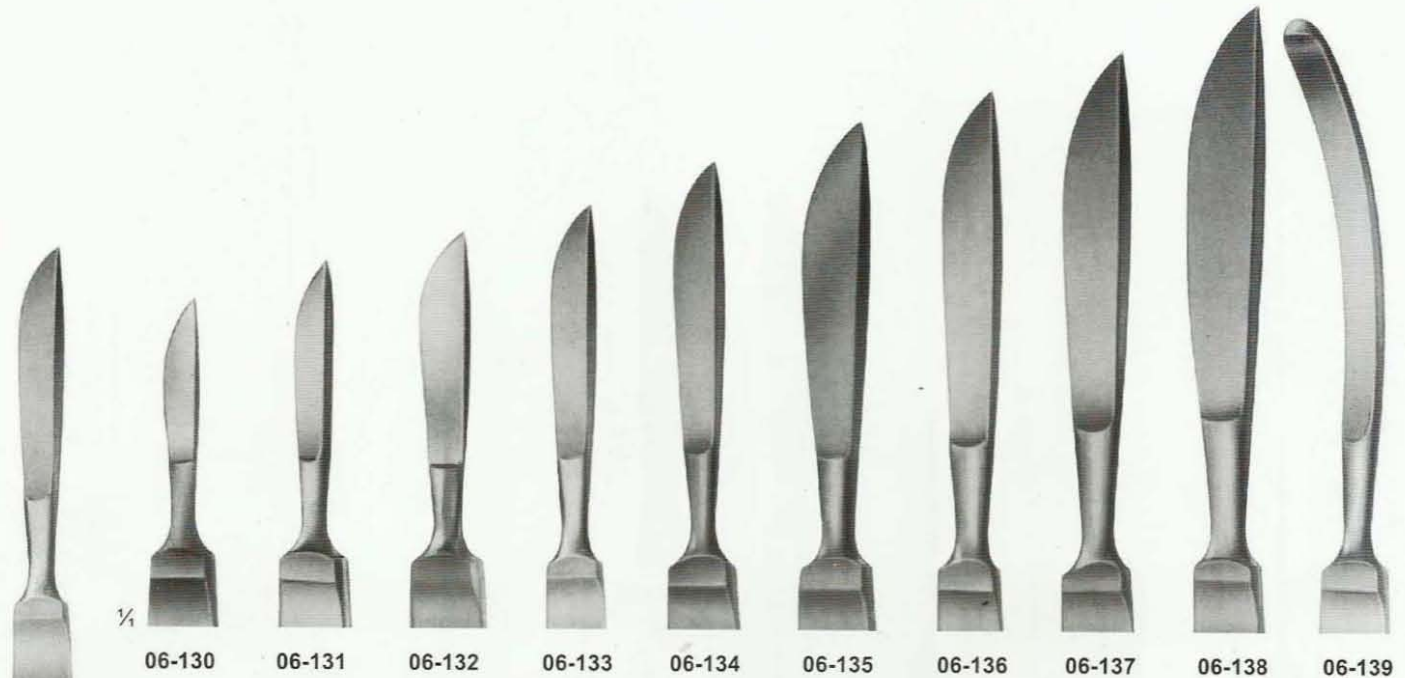

06-130 - 149
Size: 140 mm - 175 mm

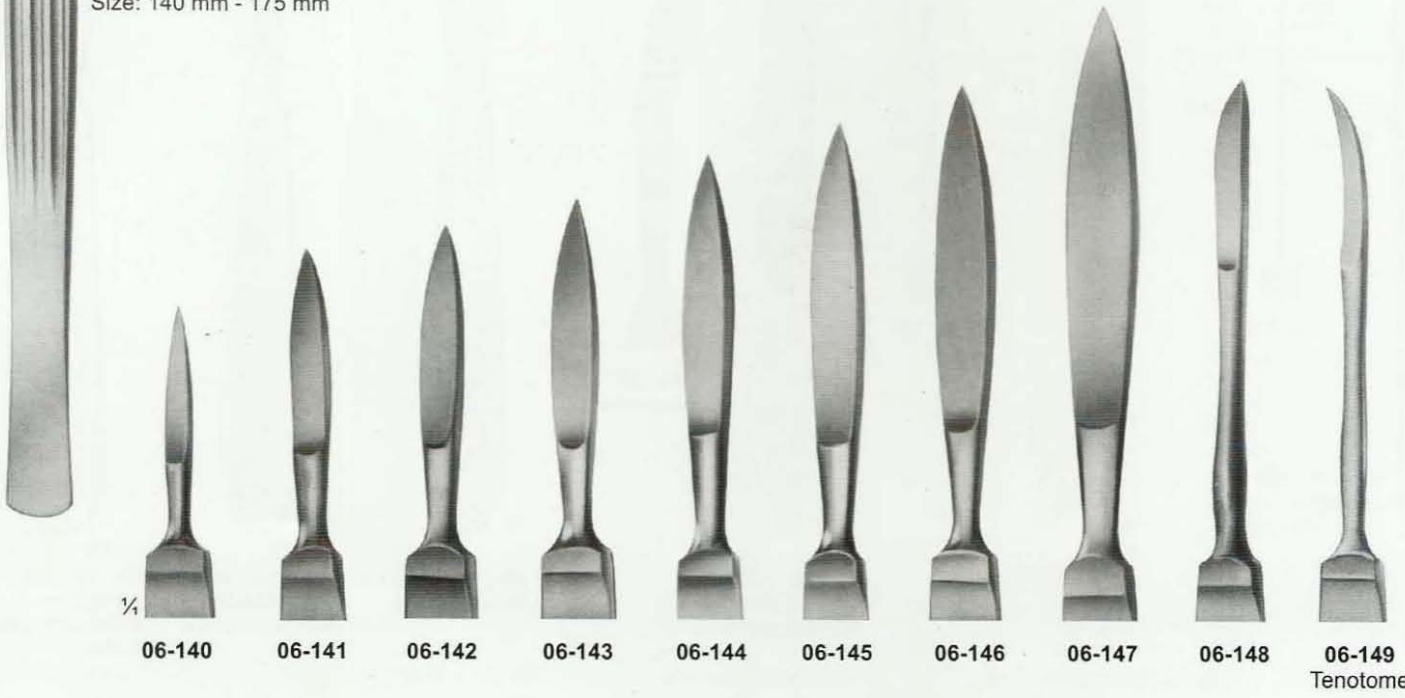

Double Cutting

Double Cutting



06-150
LISTON
Size: 130 mm
06-151
Size: 160 mm
06-152
Size: 190 mm
06-153
Size: 220 mm

06-154
CATLIN
Size: 160 mm
Blade Length
Amputating
Knives

06-155
LANGENBECK
Size: 120 mm
Blade Length
Flap Knives

06-156
Size: 110 mm
Blade Length
Interosseous
Knives

06-157
Size: 55 mm
Blade Length
With Raspatory,
Wooden Handle

06-158
Size: 70 mm
Blade Length
Wooden Handle

06-159
Size: 80 mm
Blade Length
Metal Handle

06-160
Size: 195 mm
Blade Length
Metal Handle

Blade Length (Amputating Knives)

Cone Knives, Myomatome,
Trigeminal & Tonsil Knives



06-161
AYRE
Size: 235 mm
Cone Knife

06-162
Size: 230 mm
Cone Knife

06-163
SEGOND
Size: 270 mm
Myomatome

06-164
OLIVECRONA
Size: 205 mm
Trigeminal
Knife

06-165
Size: 230 mm
Trigeminal
Knife

06-166
FOWLER
Size: 200 mm
Tonsil Knife

06-167
ABRAHAM
Size: 215 mm
Tonsil Knife

06-168
BRUENINGS
Size: 215 mm
Tonsil Knife

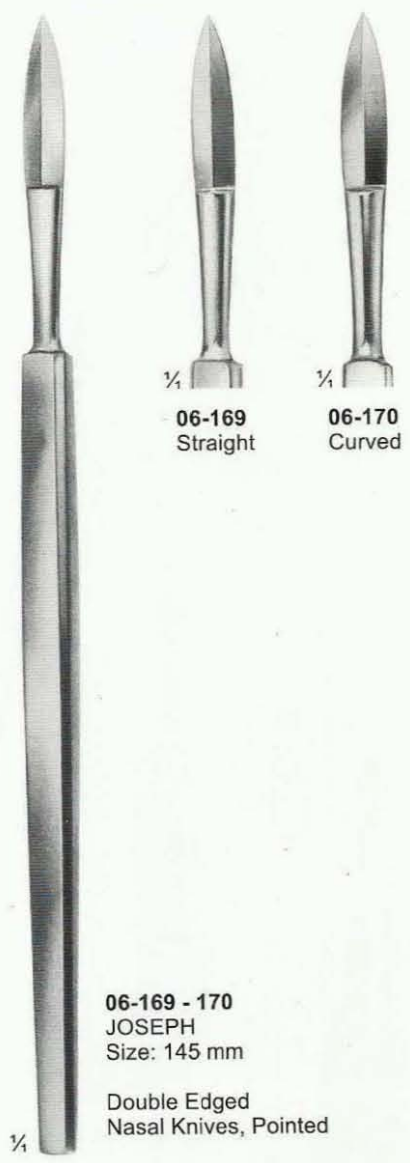

06-169
Straight

06-170
Curved

06-169 - 170
JOSEPH
Size: 145 mm

Double Edged
Nasal Knives, Pointed

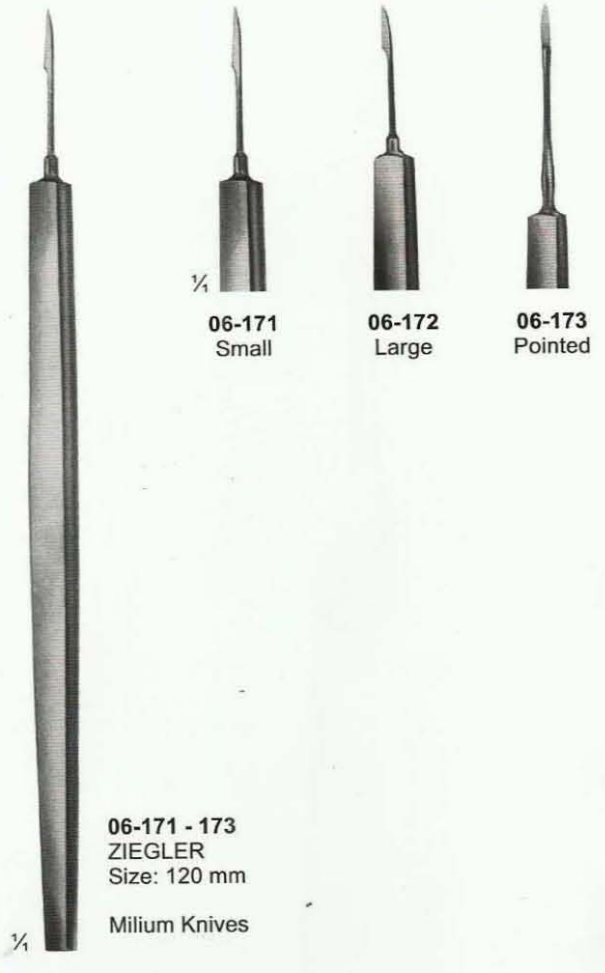

06-171
Small

06-172
Large

06-173
Pointed

06-171 - 173
ZIEGLER
Size: 120 mm

Milium Knives



06-174
VIDAL
Lupus Scraper
Size: 135 mm

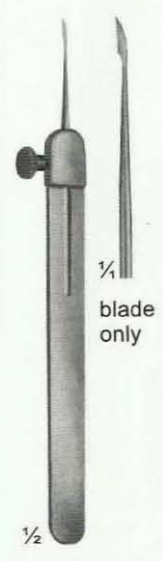

06-175
MONCORPS
Milium Knives
Size: 130 mm



06-176
SAALFELD
Milium Knives
Size: 100 mm



06-177
HEBRA
Milium Knives
Size: 180 mm



06-178
Milium Knife
Size: 145 mm



06-179
UNNA
Milium Knife
Size: 145 mm



06-180
 TROUTMAN-CHRIS
 Size: 90 mm
 Handle Diameter 5.5 mm



06-181
 TROUTMAN-CHRIS
 Size: 90 mm
 Handle Diameter 5.5 mm

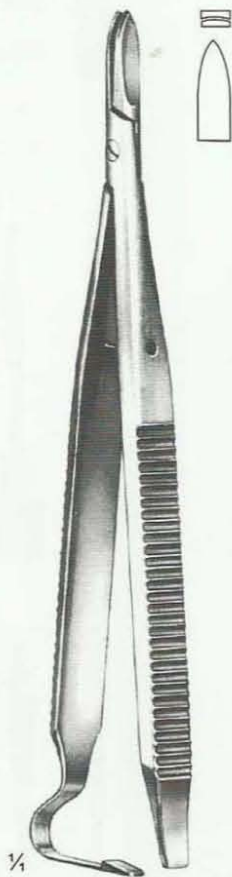

06-182
 Size: 110 mm

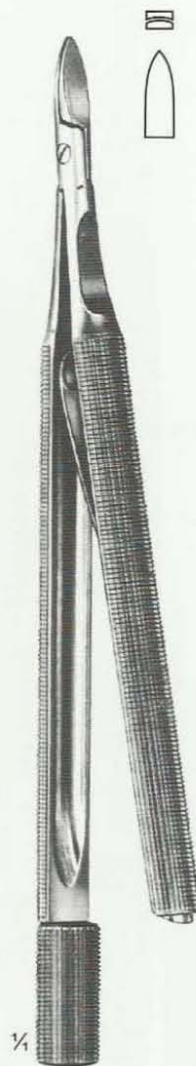

06-183
 CASTROVIEJO
 Size: 130 mm
 Handle Diameter 8 mm



06-184
 Size: 185 mm
 Razor Blade
 Breaker & Holder,
 Straight



06-185
STANDARD
No. 4
Solid



06-186
Double Handle
No. 4 + No. 3
Solid

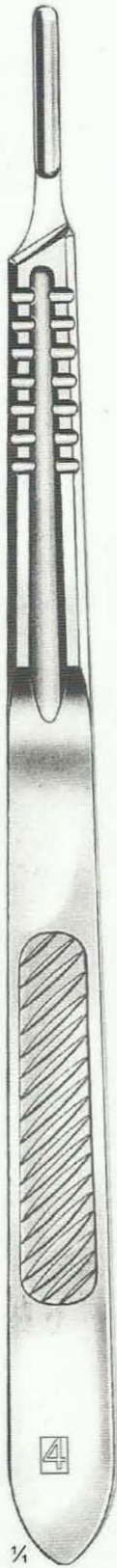

06-187
No. 4 L
Straight
Solid

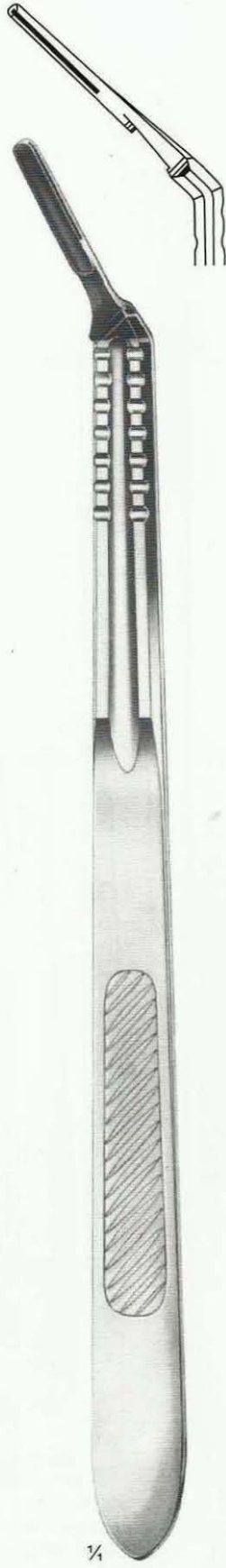

06-188
No. 4 L
Solid Angled



06-189
COLLIN
No. 8
Hollow

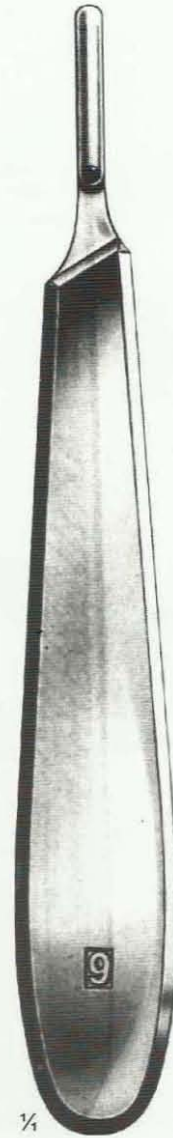

06-190
COLLIN
No. 9
Hollow



06-191
Plastic
No.4

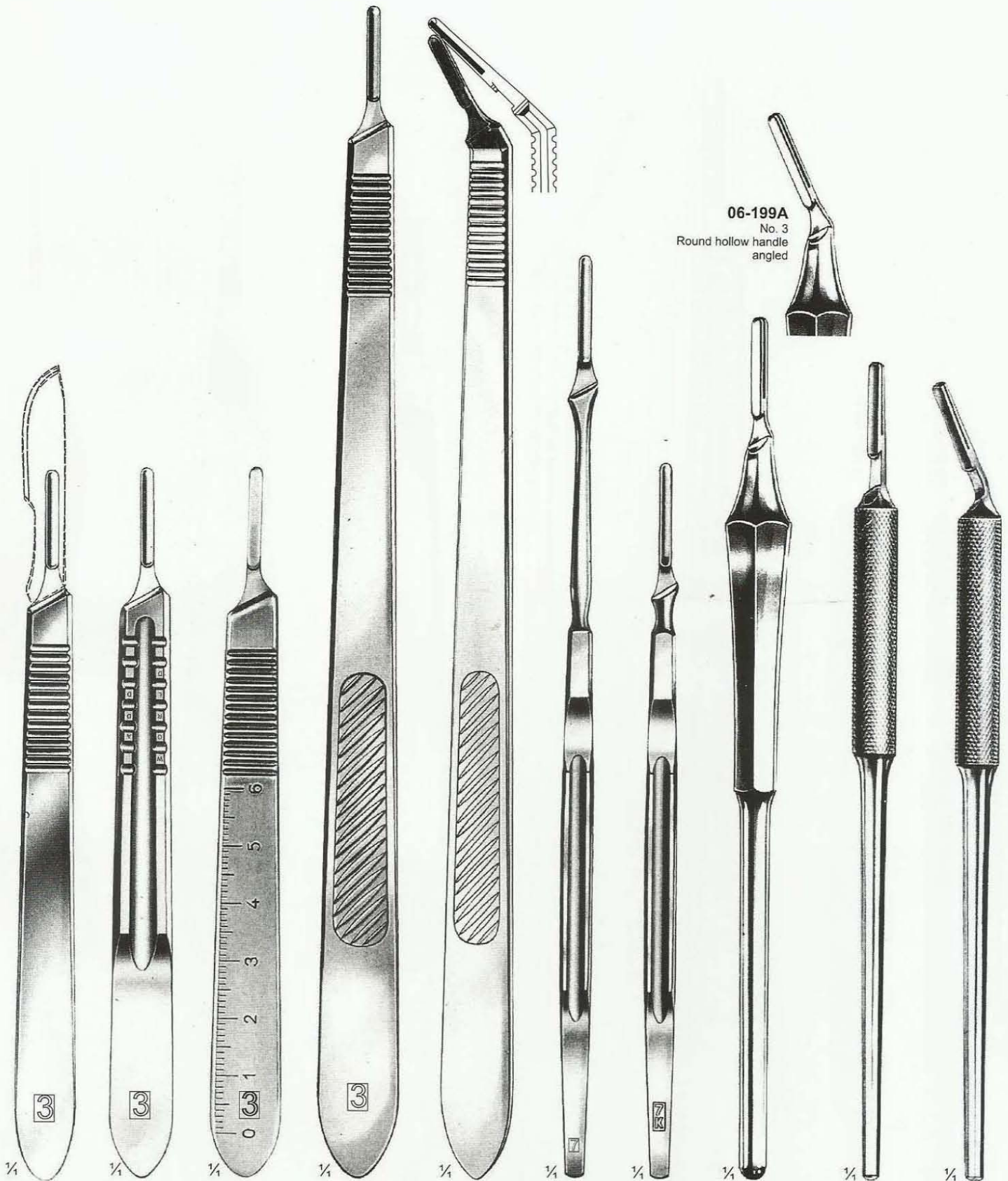

06-199A
No. 3
Round hollow handle
angled

06-192
STANDARD
No. 3
Solid
Size:12cm

06-193
No. 3
Solid
Size:12cm
solid handle
style as
No.4

06-194
No. 3
Solid
Size:12cm
cm-graduation

06-195
No. 3 L
Straight
Solid, long
Size:21.5cm

06-196
No. 3 L
Angled
Solid, long
Size:21cm

06-197
No. 7
Solid
Size:16cm

06-198
No. 7 K
Solid, short
Size:12.5cm

06-199
No.3
Size:15.5cm
with round
hollow handle

06-200
No. 3
Straight
Solid,
Round
Size:14.5cm

06-201
No. 3
Angled
Solid, Round
Size:14cm

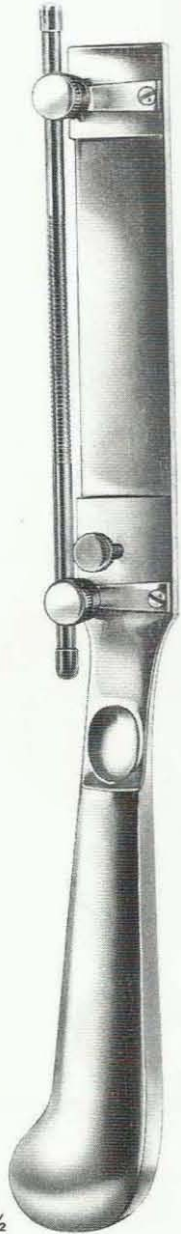

1/2

06-202
SCHINK
Size: 310 mm
Complete with 2
skin fixing plates
and 1 blade.
Adjustable from
0.1 to 2.0mm



1/2

06-203
SCHINK
Spare Blade

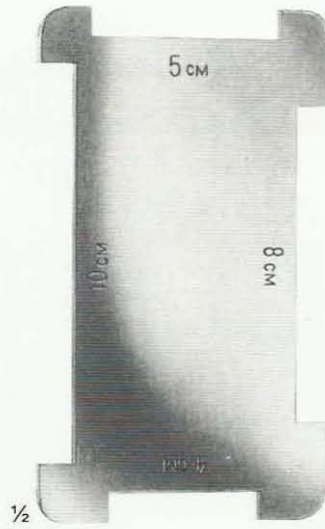

1/2

06-204
SCHINK
Skin Fixing Plate

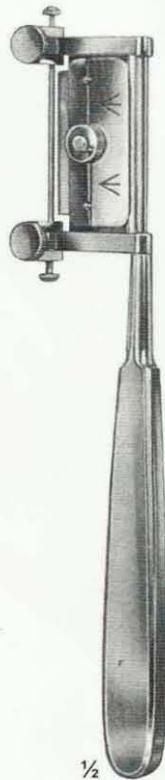

1/2

06-205
SILVER
Size: 190 mm
For Usual
Razor Blades

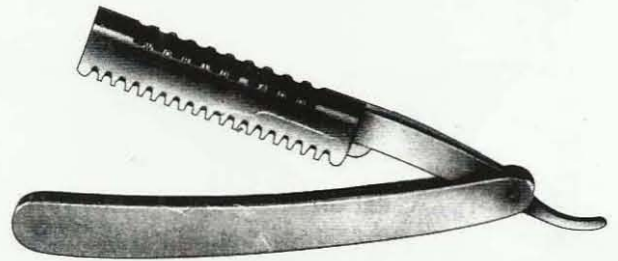

06-207A
Razor for interchangeable
blades, with safety clip

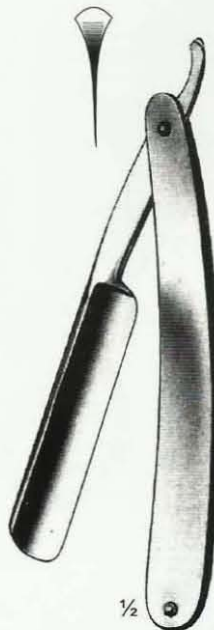

1/2

06-206
Size: 75 mm
Cutting Length

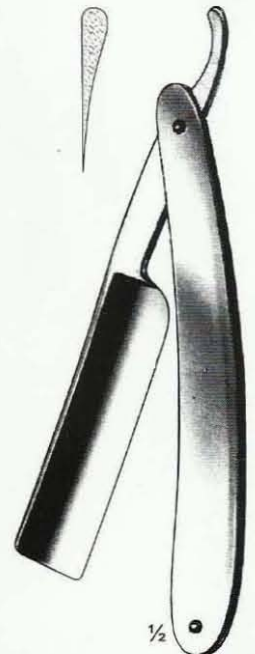

1/2

06-207
Size: 80 mm
Cutting Length

	SECTION	PAGE
Scissors	07	23-51
Forceps		
Clamps	8-9-10	52-95



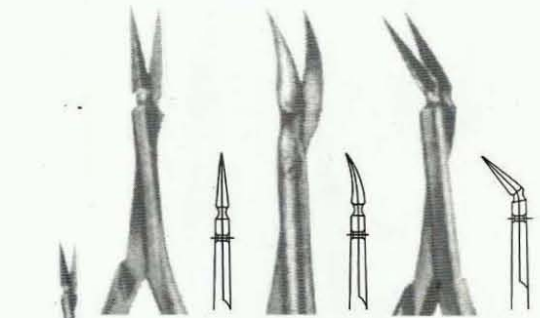

07-101 07-102 07-103



23-07-101 - 103
VANNAS
Size: 85 mm

¼

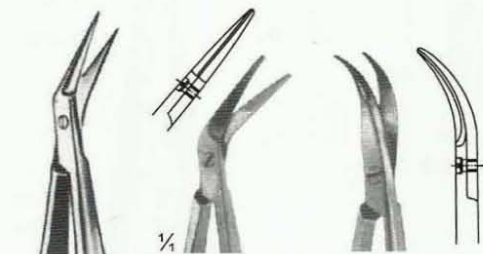

07-104 07-105
angled to side



23-07-104 - 105
CASTROVIEJO
Size: 95 mm

¼

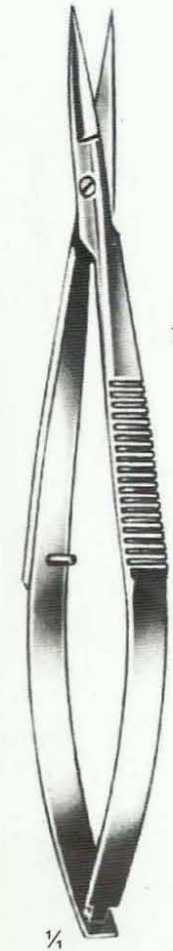
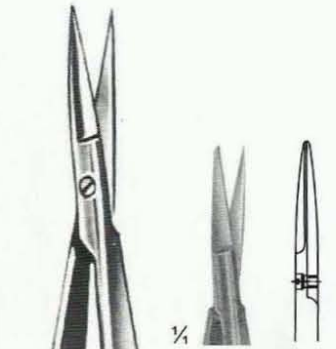

23-07-106
NOYES
Size: 125 mm

¼



07-107 07-108



23-07-107 - 108
WECKER
Eye Scissor
Size: 110 mm

½



23-07-109
CASTROVIEJO
Eye Scissor
Size: 115 mm

¼

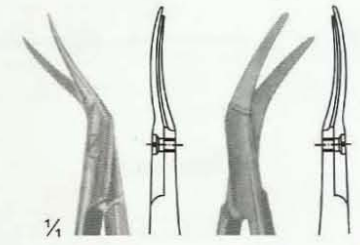
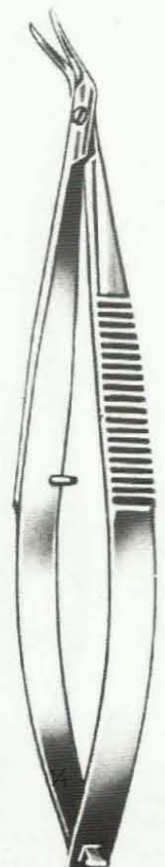

07-110 07-111

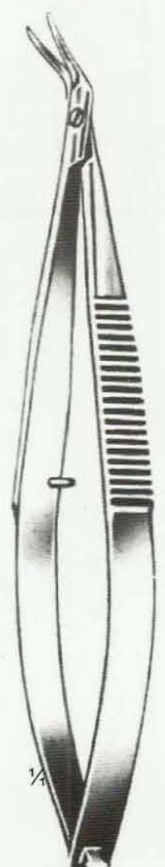

23-07-110 - 111
CASTROVIEJO
Eye Scissor
Size: 110 mm

¼

Micro Scissors, "Spring Type"
Flat Handles and Cross-Serration

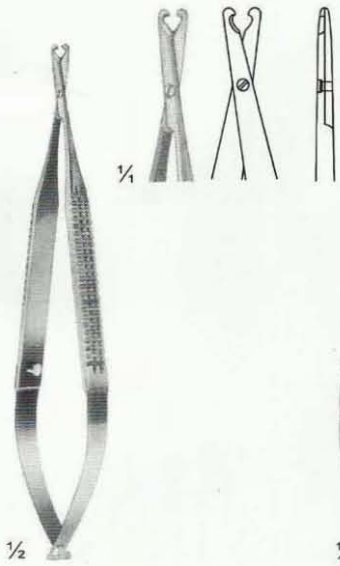

07-112
BIEMER
 Vein Scissor
 Size: 130 mm

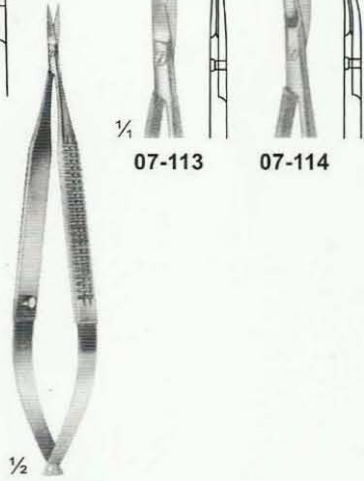

07-113 - 114
 Size: 120 mm



07-115 - 116
 Size: 160 mm



07-117 - 118
VANNAS
 Size: 160 mm



07-119
CASPAR
 Micro Scissor Curved

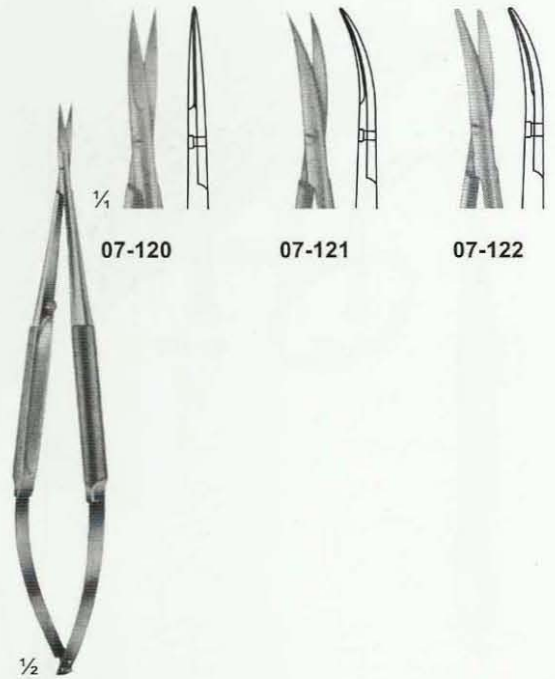

07-120 - 122
 Micro Dissecting Scissor
 Size: 145 mm

Micro Scissors, "Spring Type" Bayonet Shape

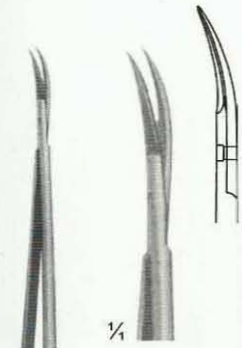

07-123
YASARGIL
Size: 245 mm

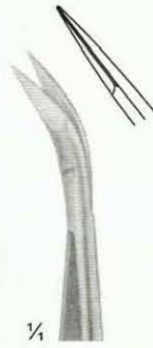

07-124
45°
Nagel

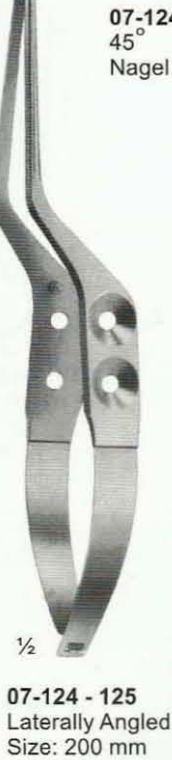
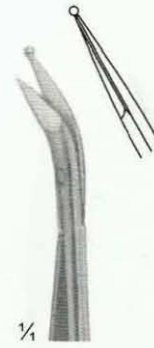

07-125
45°

07-124 - 125
Laterally Angled
Size: 200 mm

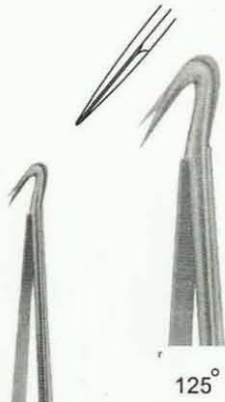

07-126
Laterally Angled
Size: 190 mm



07-127

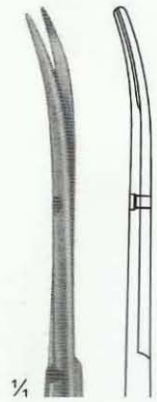

07-127 - 128
YASARGIL
Size: 225 mm

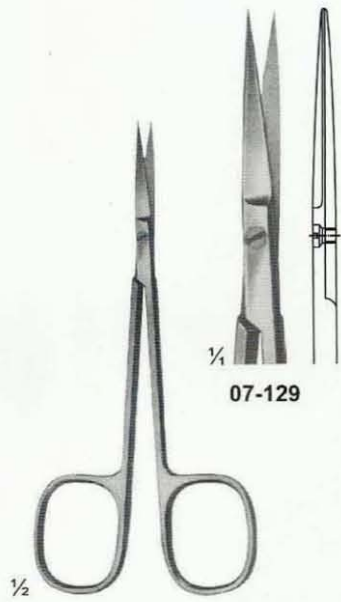

07-129

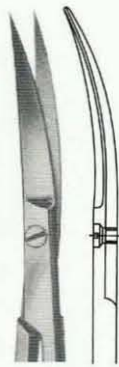

07-130

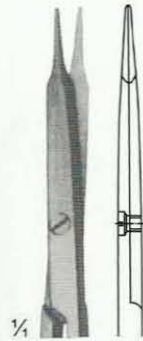

07-131
Sharp



07-132
Sharp



07-133
Blunt

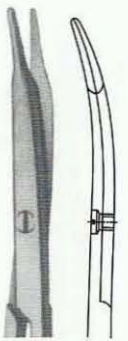

07-134
Blunt

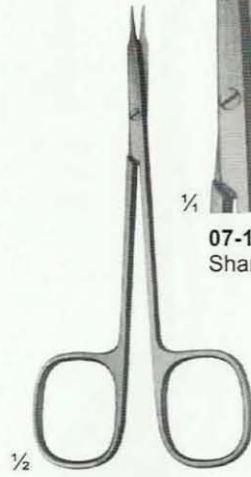

07-131 - 134
STEVENS
Dissecting Scissors
Size: 115 mm

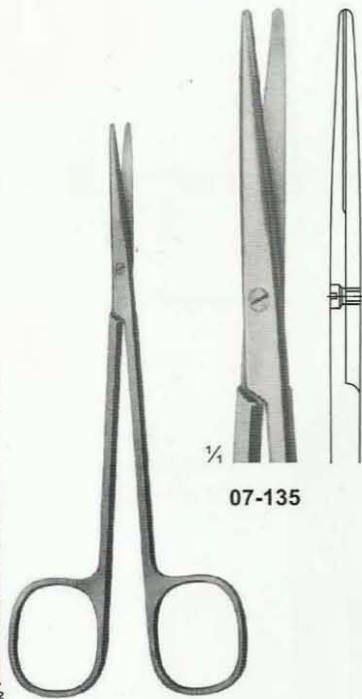

07-135

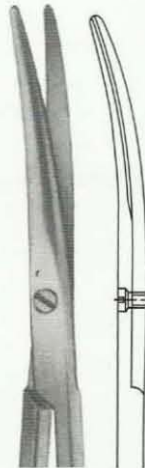

07-136

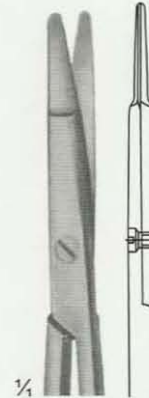

07-137
RAGNELL
Size: 135 mm

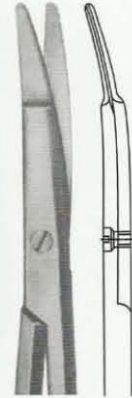

07-138
RAGNELL
Size: 135 mm

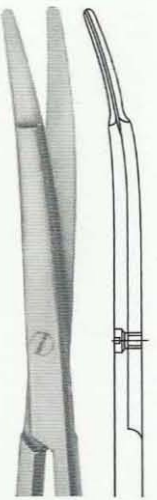

07-139
Size: 150 mm

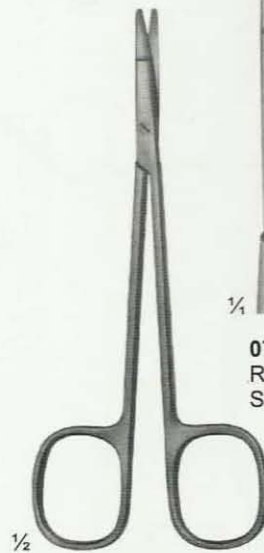

07-137 - 139
Special flat points for
dissecting and
undermining the skin

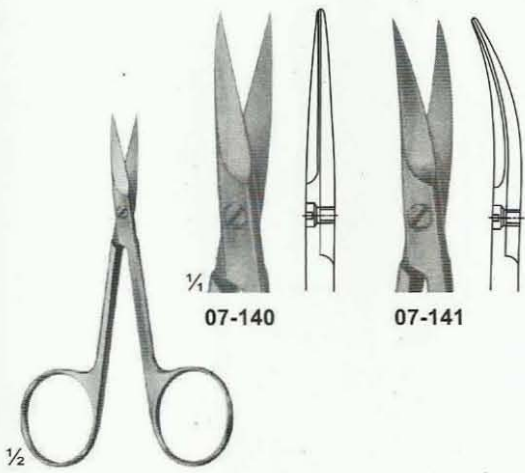

07-140

07-141

07-140 - 141
Size: 90 mm



07-142

07-143

07-142 - 143
Size: 95 mm

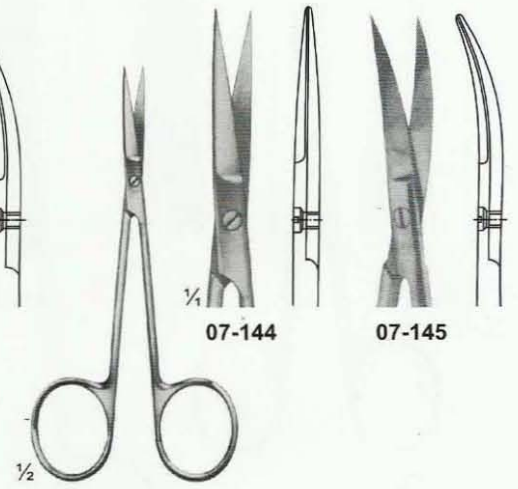

07-144

07-145

07-144 - 145
Size: 105 mm

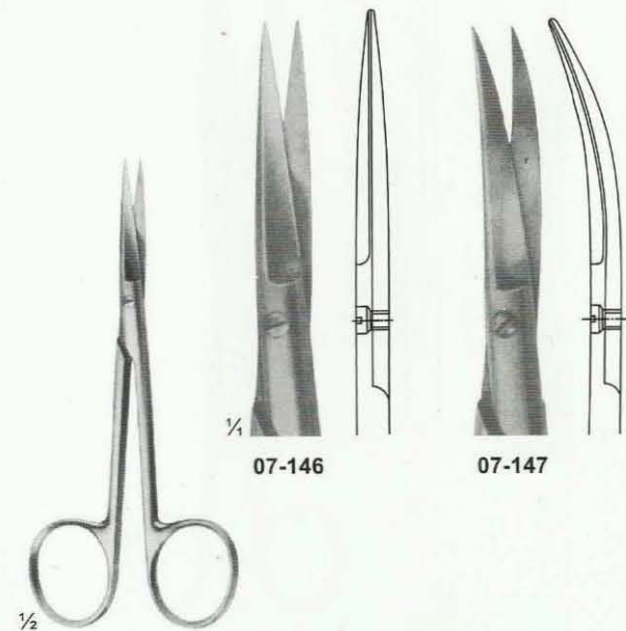

07-146

07-147

07-146 - 147
Size: 120 mm

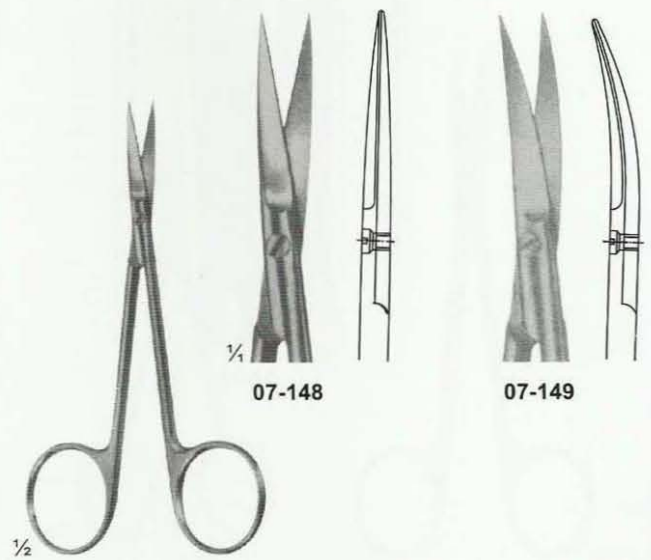

07-148

07-149

07-148 - 149
Size: 115 mm

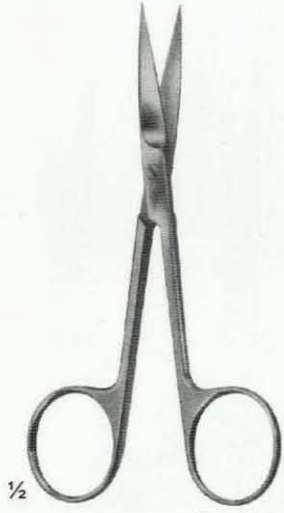

07-150 - 152
Size: 120 mm

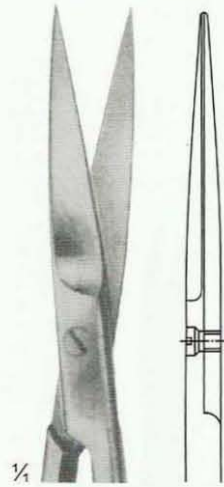

07-150

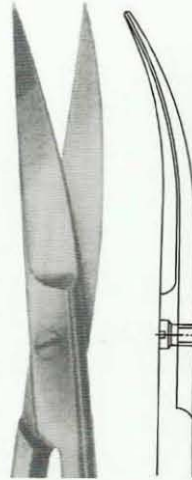

07-151

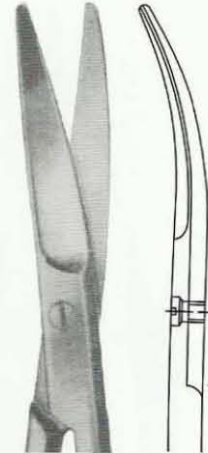

07-152

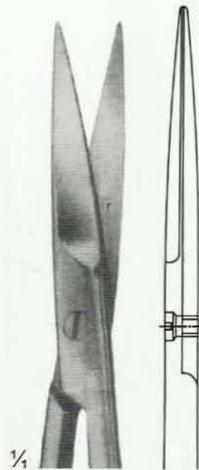

07-153

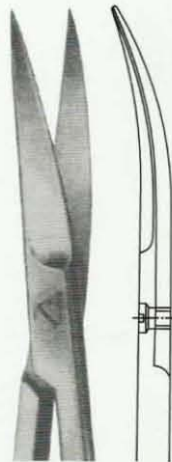

07-154

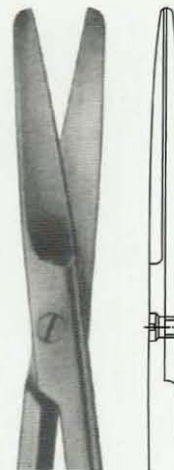

07-155

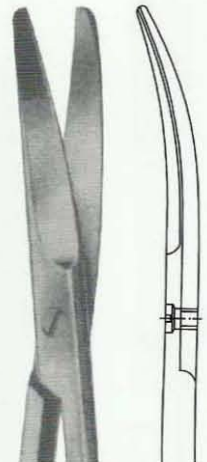

07-156



07-153 - 156
Size: 130 mm

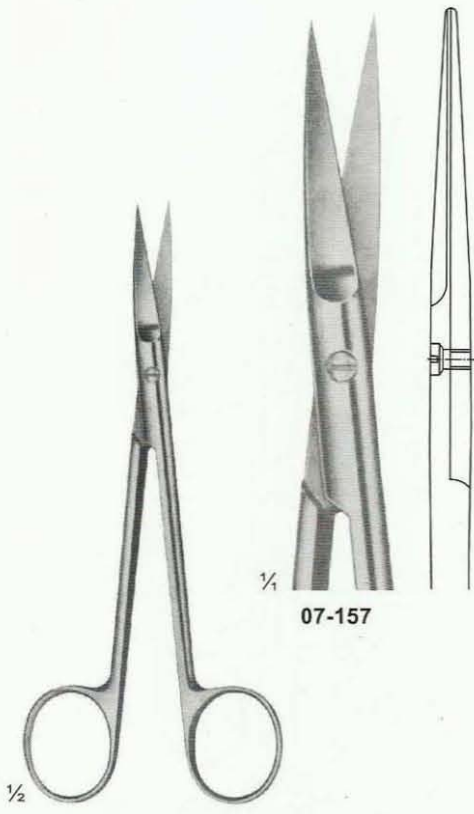

07-157 - 158
JOSEPH
Size: 150 mm

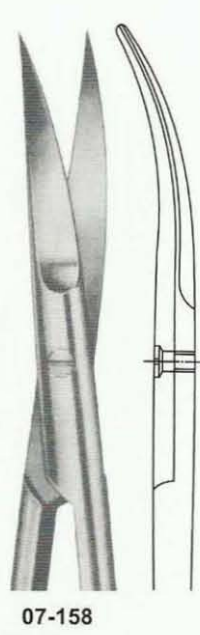

07-159 - 160
KELLY
Size: 175 mm

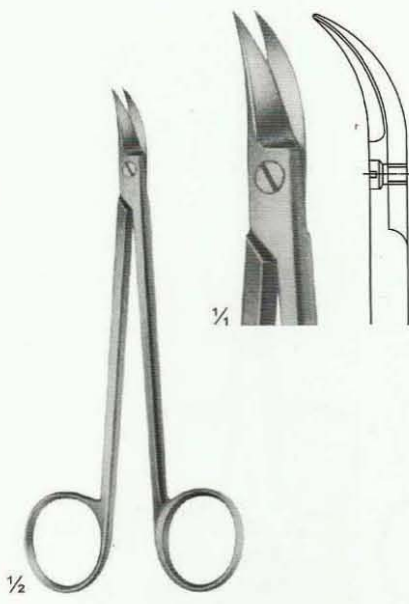

07-161
QUINBY
Size: 130 mm

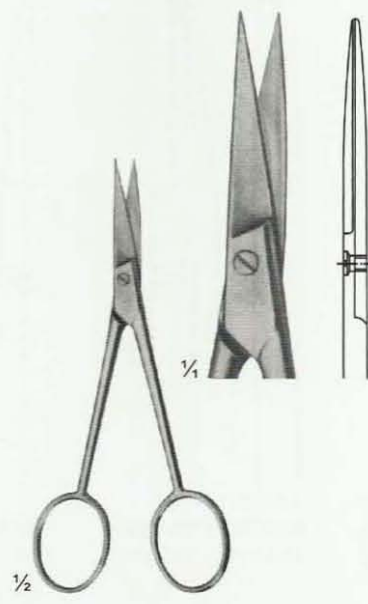

07-162
Size: 110 mm

½

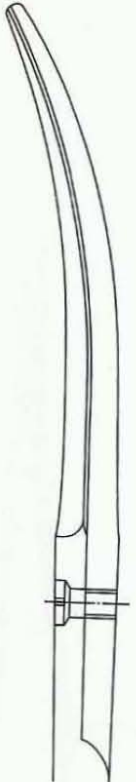
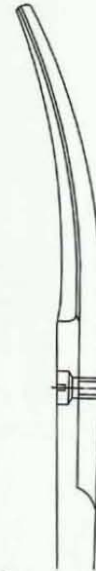
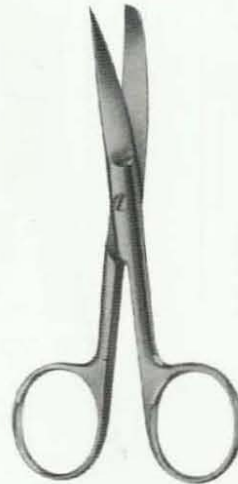
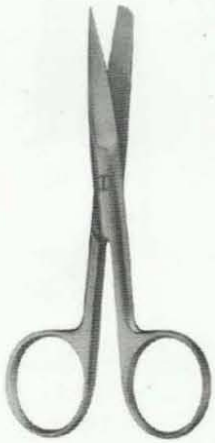

07-163 - 171 (Standard Types)
 07-163 (105 mm)
 07-164 (115 mm)
 07-165 (130 mm)
 07-166 (145 mm)
 07-167 (150 mm)
 07-168 (165 mm)
 07-169 (175 mm)
 07-170 (185 mm)
 07-171 (200 mm)

07-163
 Size: 105 mm

07-171
 Size: 200 mm

07-172 - 178 (Standard Types)
 07-172 (115 mm)
 07-173 (130 mm)
 07-174 (145 mm)
 07-175 (150 mm)
 07-176 (165 mm)
 07-177 (175 mm)
 07-178 (185 mm)

07-172
 Size: 115 mm

07-178
 Size: 185 mm

30

½

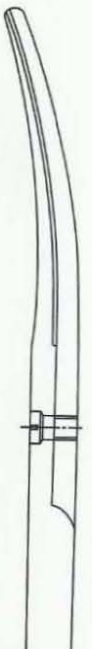

07-179 130 mm
07-180 145 mm

07-181 130 mm
07-182 145 mm

07-183
 130 mm

07-184
 130 mm

07-179 - 182
 Slender Types

07-183 - 184
 For Wound Edges



31-07-185 (130 mm)
 31-07-186 (145 mm)
 31-07-187 (150 mm)
 31-07-188 (165 mm)
 31-07-189 (175 mm)
 (Standard Types)



31-07-185
 Size: 130 mm

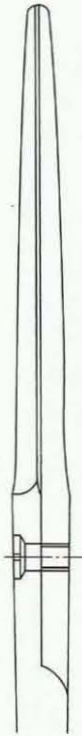

31-07-189
 Size: 175 mm



COOPER
 Standard Types
 31-07-190 (115 mm)
 31-07-191 (130 mm)
 31-07-192 (145 mm)
 31-07-193 (150 mm)
 31-07-194 (165 mm)
 31-07-195 (175 mm)



31-07-190
 Size: 115 mm

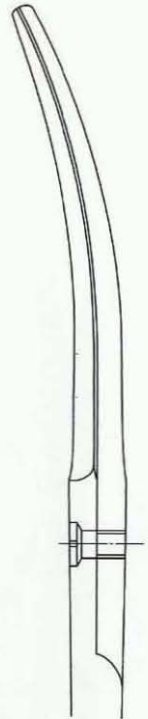

31-07-195
 Size: 175 mm

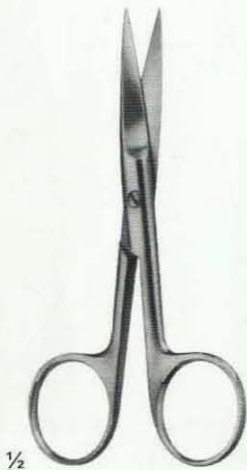

Standard Types
 31-07-196 (115 mm) 31-07-200A (115 mm)
 31-07-197 (130 mm) 31-07-201 (130 mm)
 31-07-198 (145 mm) 31-07-201A (145 mm)
 31-07-199 (150 mm) 31-07-202 (150 mm)
 31-07-200 (165 mm) 31-07-202A (165 mm)

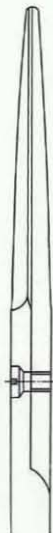

31-07-196
 Size: 115 mm



31-07-200
 Size: 165 mm



31-07-200A
 Size: 115 mm



31-07-202A
 Size: 165 mm

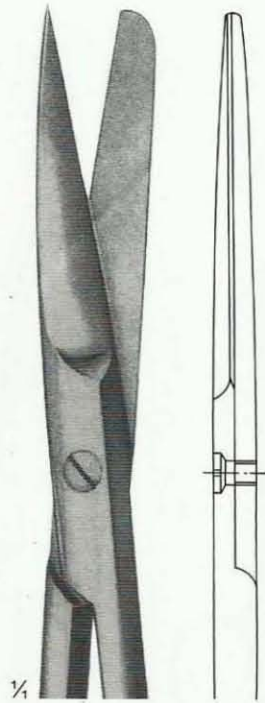
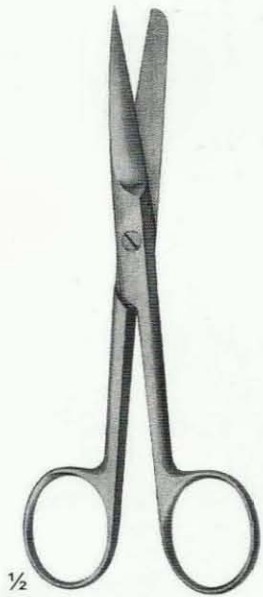

07-203
Size: 145 mm

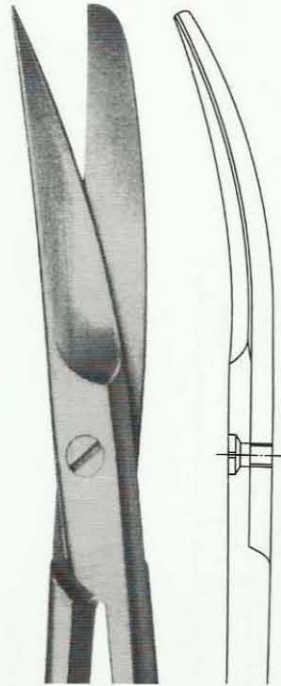

07-204
Size: 145 mm

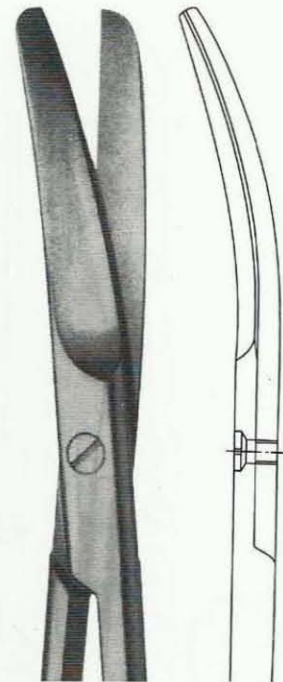

07-205
Size: 145 mm

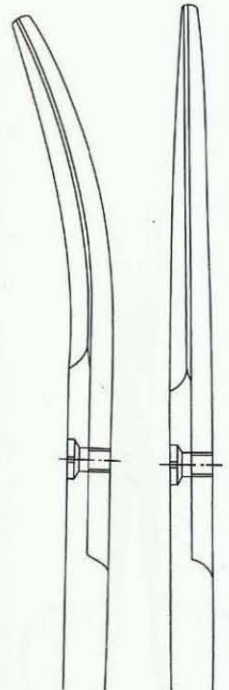

07-206
Size: 145 mm

07-203 - 206
DEAVER
With flat Lock

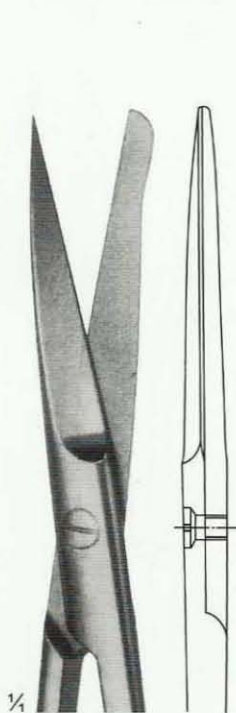
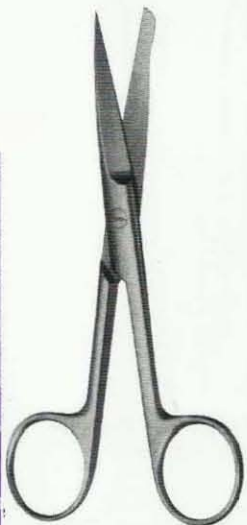

07-207
Size: 130mm



07-208
Size: 145mm

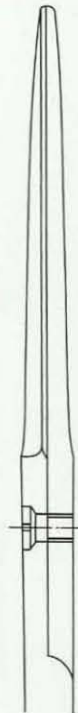

07-209
Size: 165mm

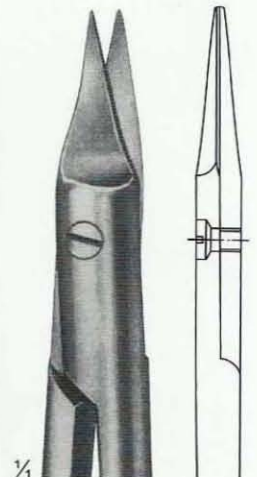
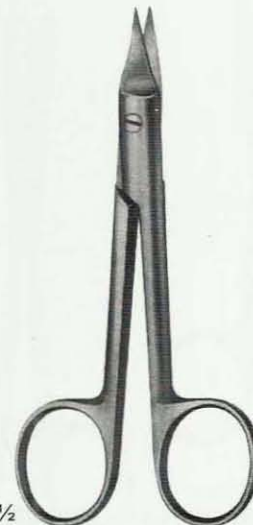

07-210 (130 mm)
SYSTRUNK
Nail Splitting Scissors

07-207 - 209
Incision Scissors

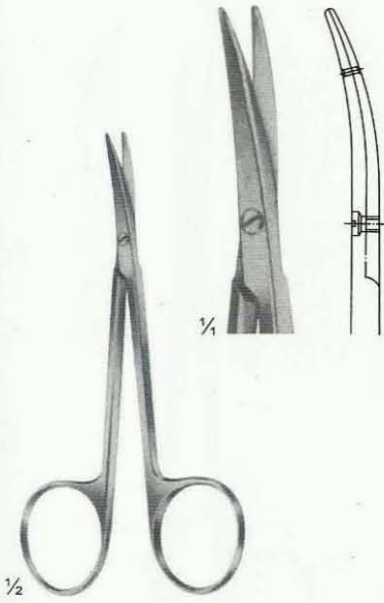

07-211
LITTLER
 Dissecting Scissors
 Tips with eye for suture
 Size: 115 mm

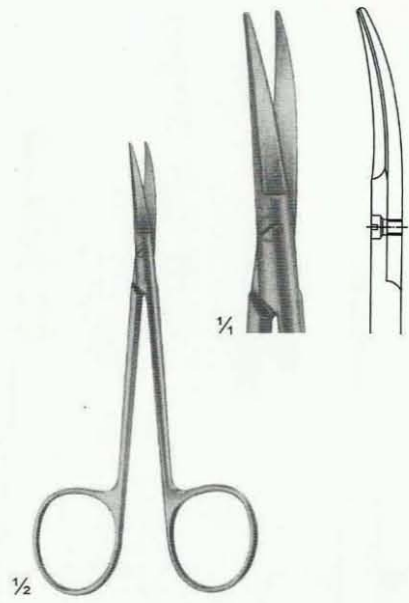

07-212
COTTLE
 Bulldog Scissors
 Size: 115 mm

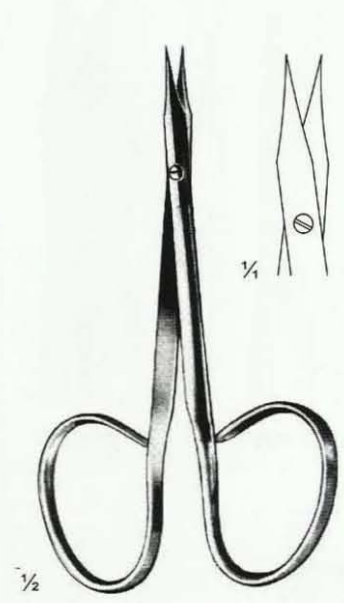

STEVENS-GRADLE
07-213 Sharp/Sharp, straight
07-213A Blunt/Blunt, straight
07-214 Sharp/Sharp, curved
07-214A Blunt/Blunt, curved
 10 cm
 Ribbon Tenotomy scissor

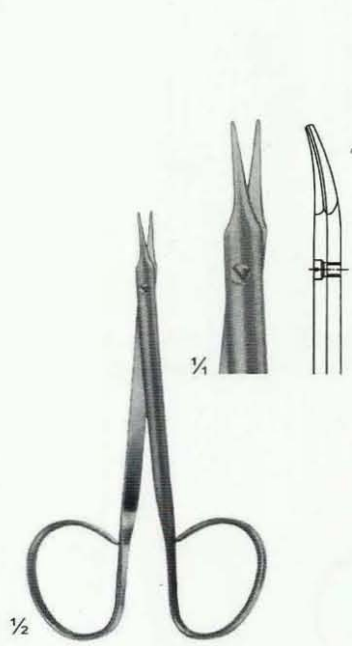

07-215
STEVENS
 Fine Dissecting Scissors
 Size: 110 mm



07-216 - 219
STEVENS
 Vessel and tendon Scissors
 Size: 110 mm

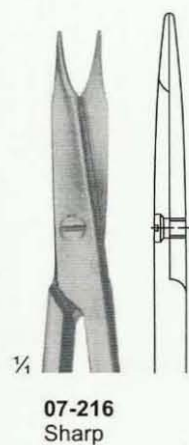

07-216
 Sharp

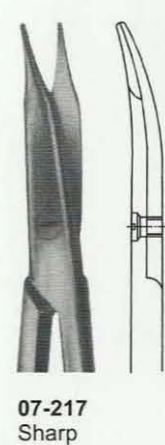

07-217
 Sharp

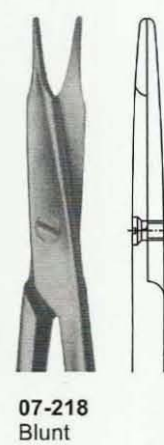

07-218
 Blunt

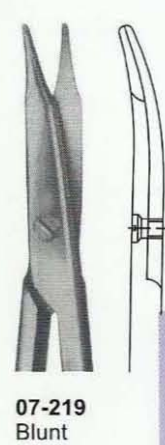

07-219
 Blunt

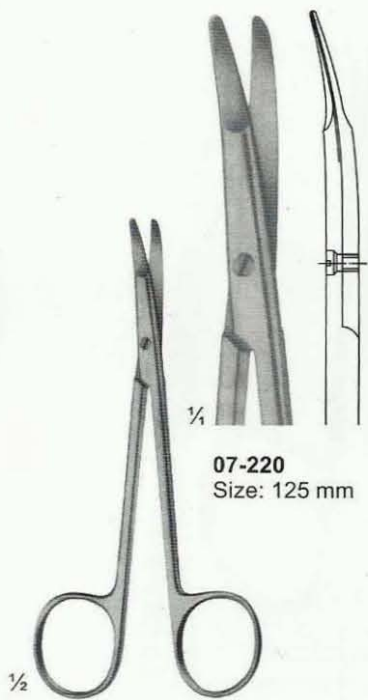

07-220
Size: 125 mm

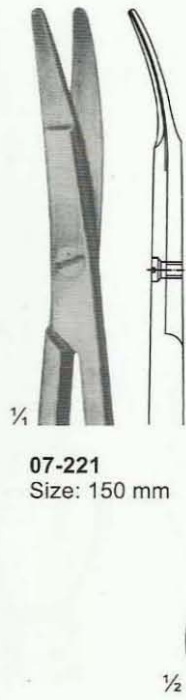

07-221
Size: 150 mm

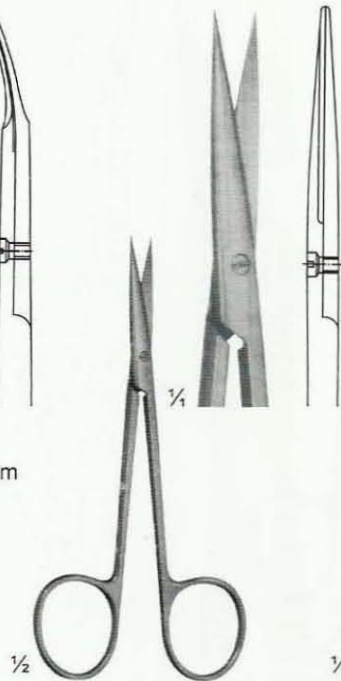

07-222
KILNER
Fine dissecting scissors
Size: 115 mm

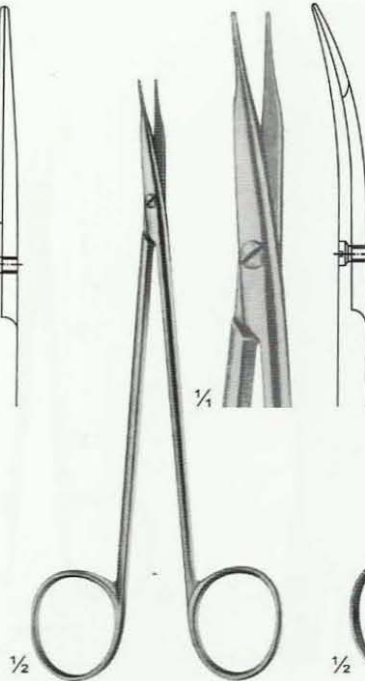

07-223
JAMESON
Dissecting scissors
Size: 150 mm

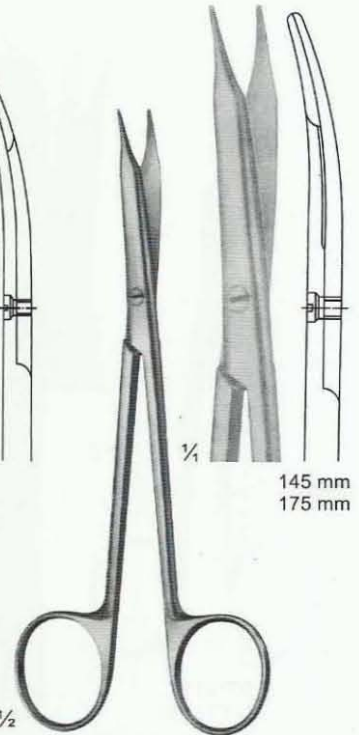

07-224 145mm
07-225 175mm
REYNOLDS
Dissecting scissors

07-220 - 221
KILNER
Special flat points for dissecting
and undermining the skin

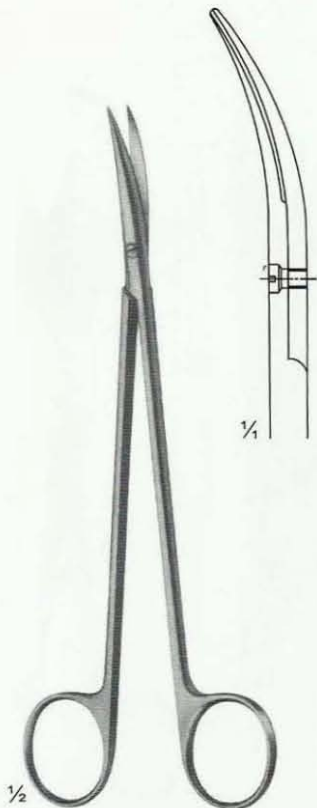

07-226
DE BAKEY
Ateriotomy scissors
Size: 175 mm



07-227
Very delicate

07-228
Delicate

07-227 - 228
TOENNIS - ADSON
Dissecting scissors
Size: 175 mm



07-229
Very delicate

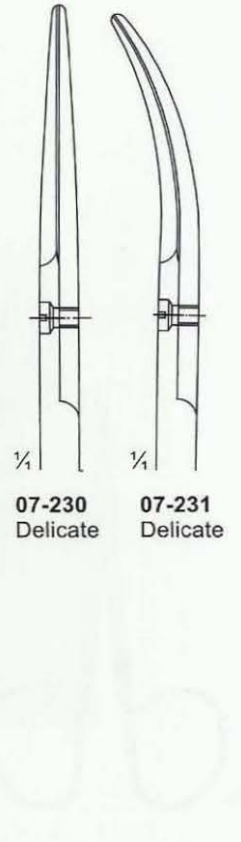

07-230
Delicate

07-231
Delicate

07-229 - 231
TOENNIS
Dissecting scissors
Size: 180 mm

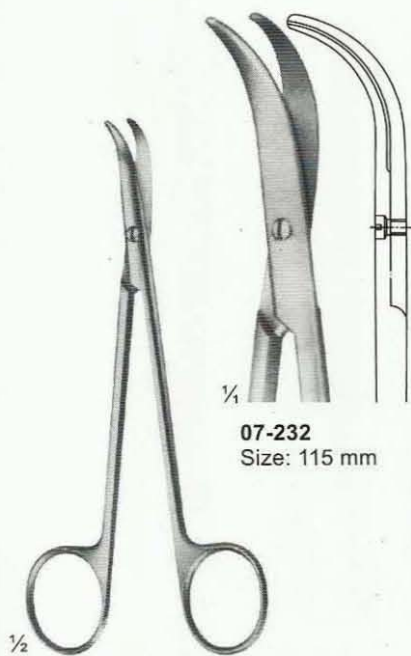

07-232
Size: 115 mm

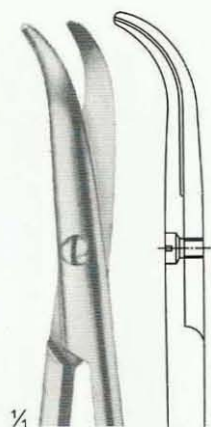

07-233
Size: 135 mm

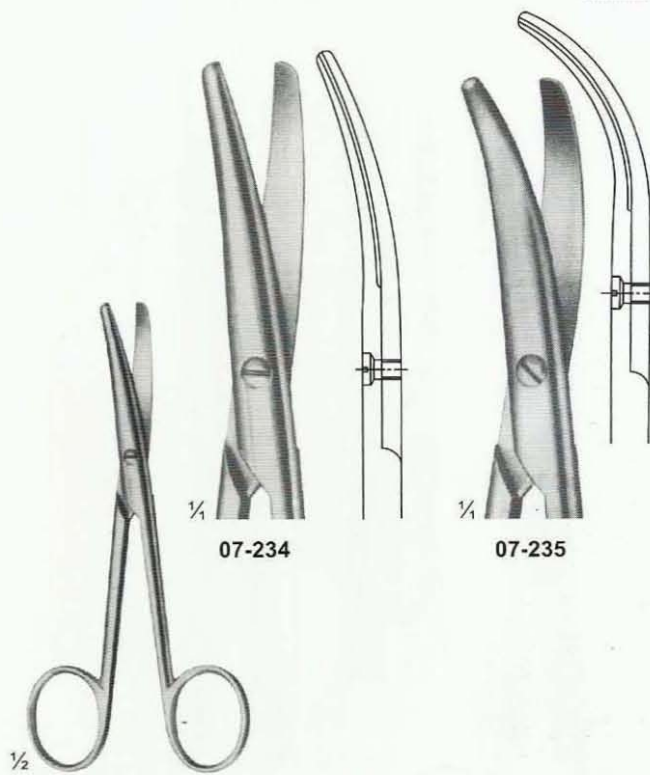

07-234

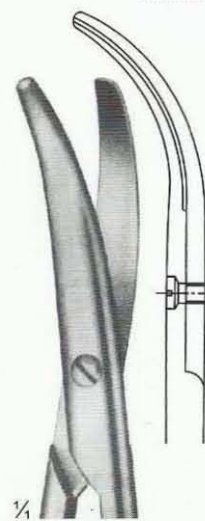

07-235

07-232 - 233
FOMON
Lower lateral scissors

07-234 - 235
LANDOLT
Enucleation scissors
Size: 120 mm

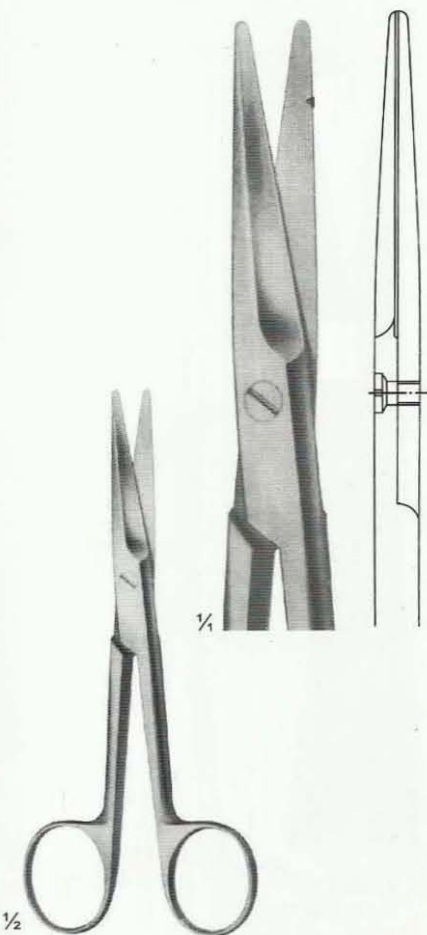

MAYO(straight)
07-236 (140 mm)
07-237 (155 mm)
07-238 (170 mm)

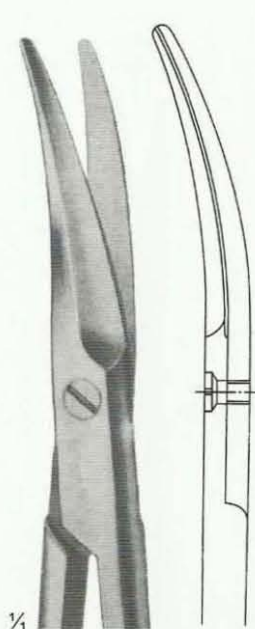

MAYO(curved)
07-239 (140 mm)
07-240 (155 mm)
07-241 (170 mm)

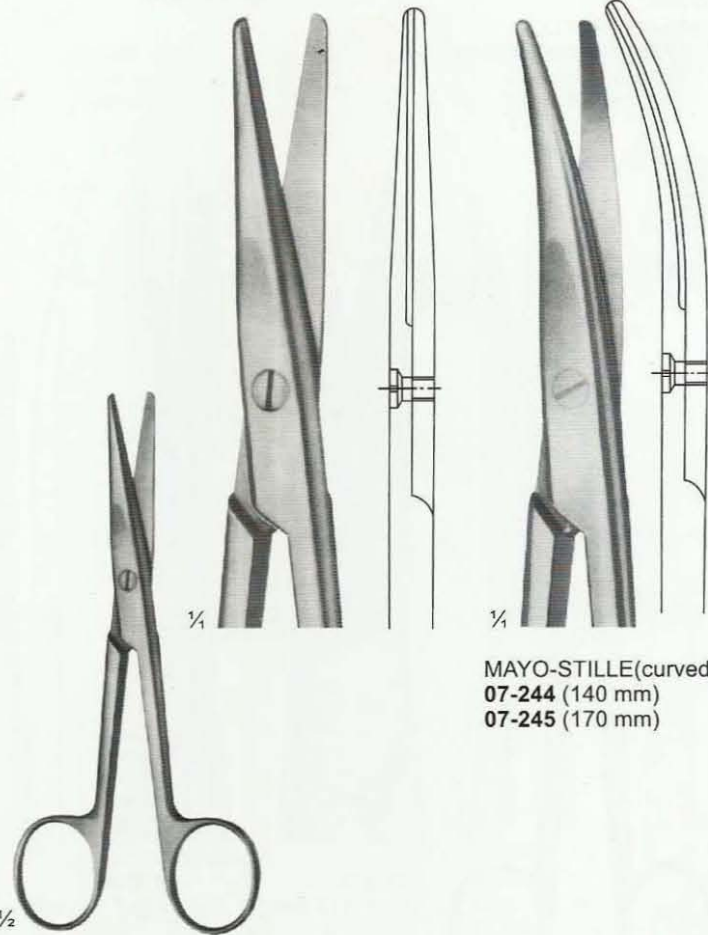

MAYO-STILLE(straight)
07-242 (140 mm)
07-243 (170 mm)

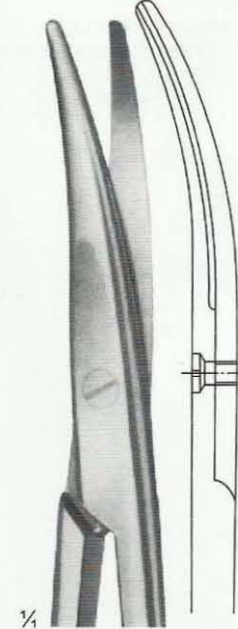

MAYO-STILLE(curved)
07-244 (140 mm)
07-245 (170 mm)

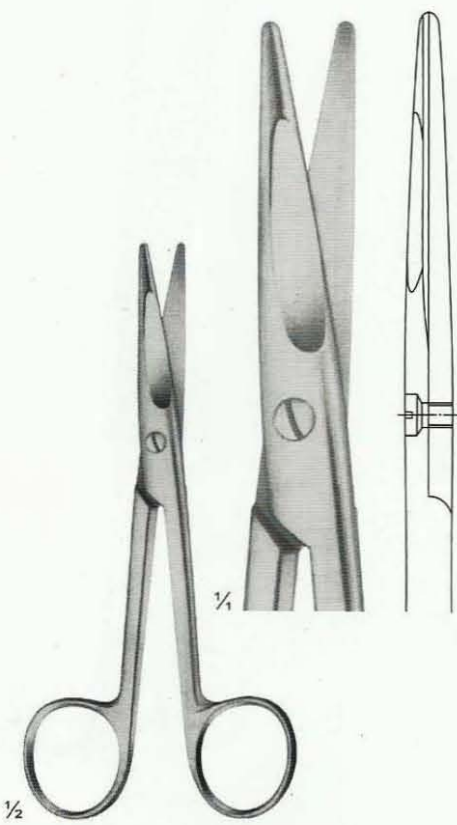

MAYO-STILLE
With chamfered blades
07-246 (140 mm)
07-247 (170 mm)

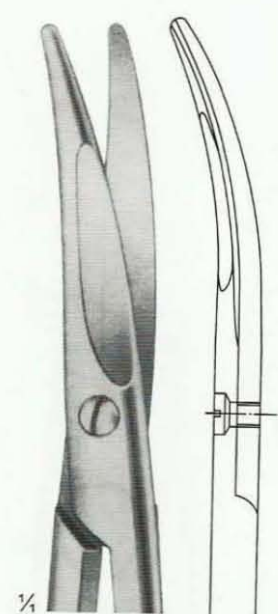

MAYO-STILLE
07-248 (14cm)
07-249 (17cm)

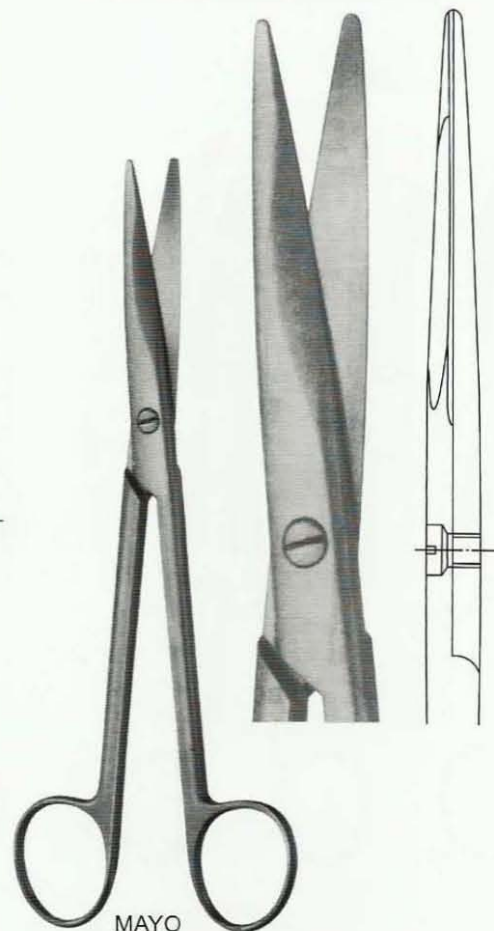

MAYO
With chamfered blades
07-250 (190 mm)
07-251 (215 mm)

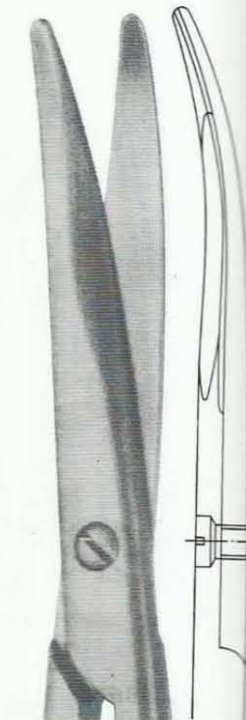

MAYO
07-252
Size: 190 mm
07-253
Size: 215 mm

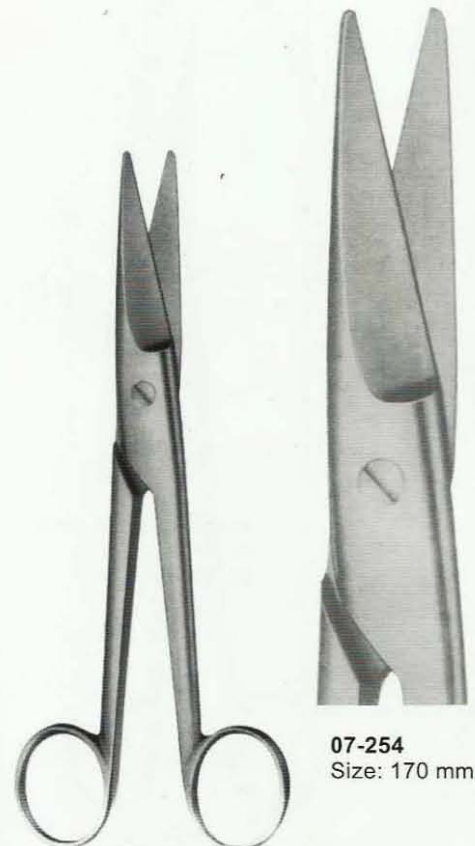

07-254 - 255
MAYO-NOBLE (Broad pattern)

07-254
Size: 170 mm

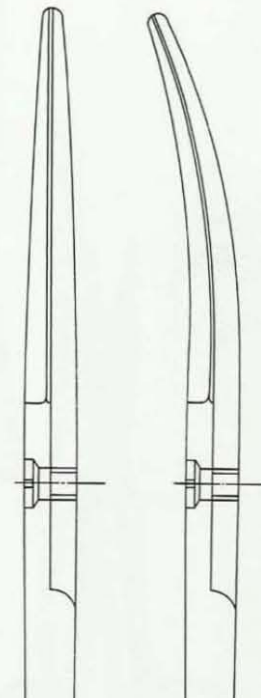

07-255
Size: 170 mm

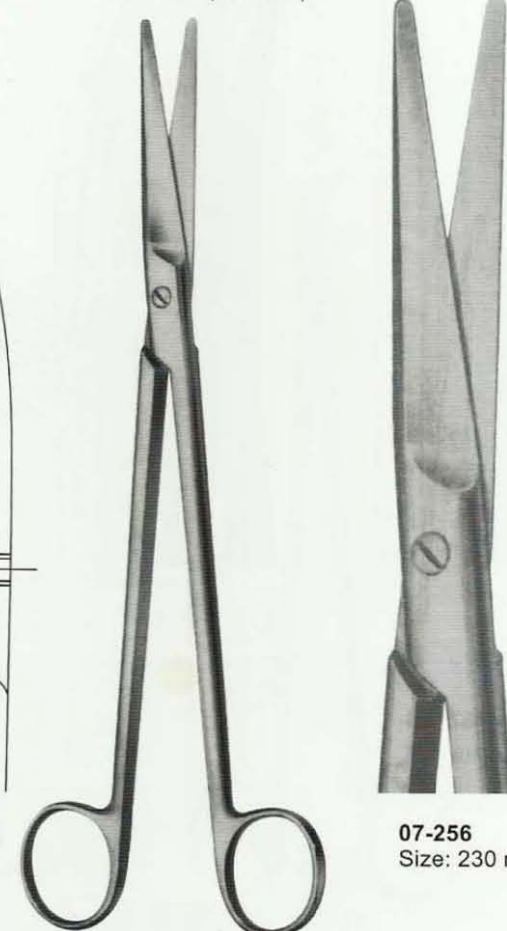

07-256 - 257
MAYO-HARRINGTON

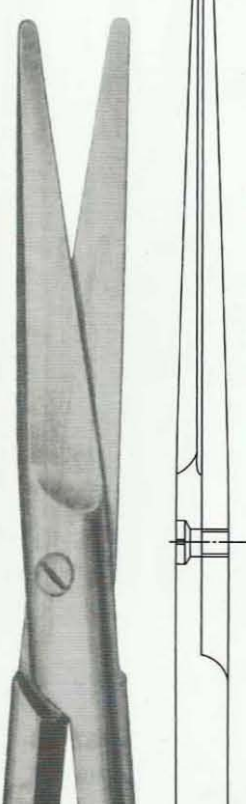

07-256
Size: 230 mm

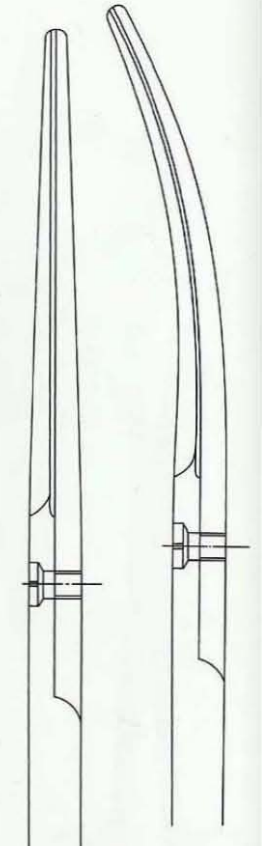

07-257
Size: 230 mm

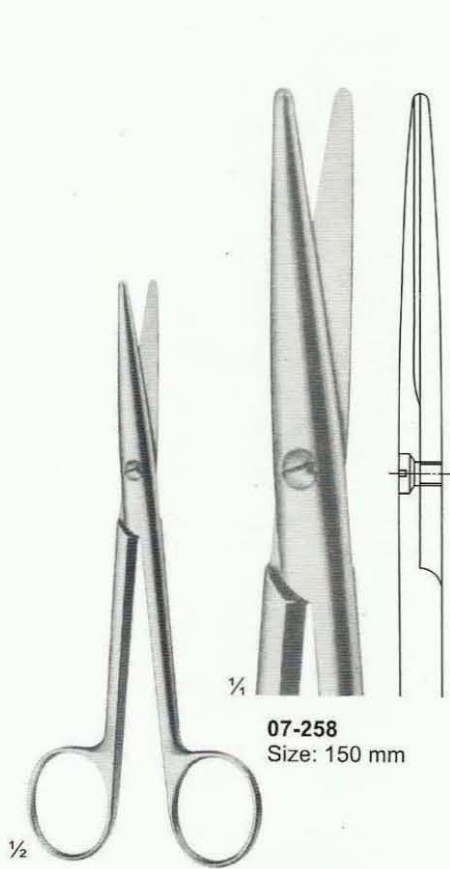

07-258
Size: 150 mm

07-258 - 259
STILLE

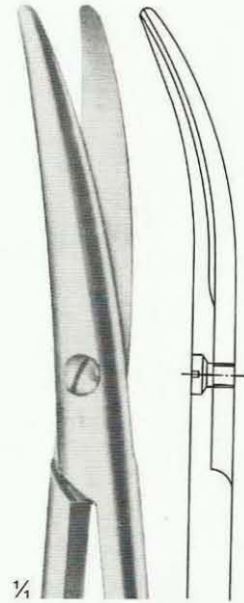

07-259
Size: 150 mm

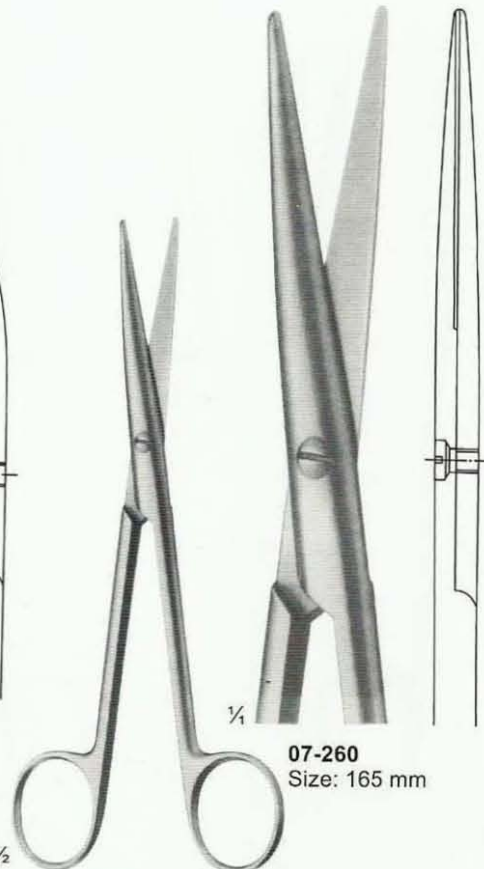

07-260
Size: 165 mm

07-260 - 261
LEXER
Narrow

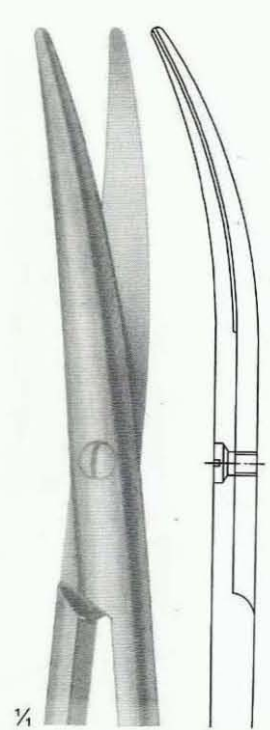

07-261
Size: 165 mm

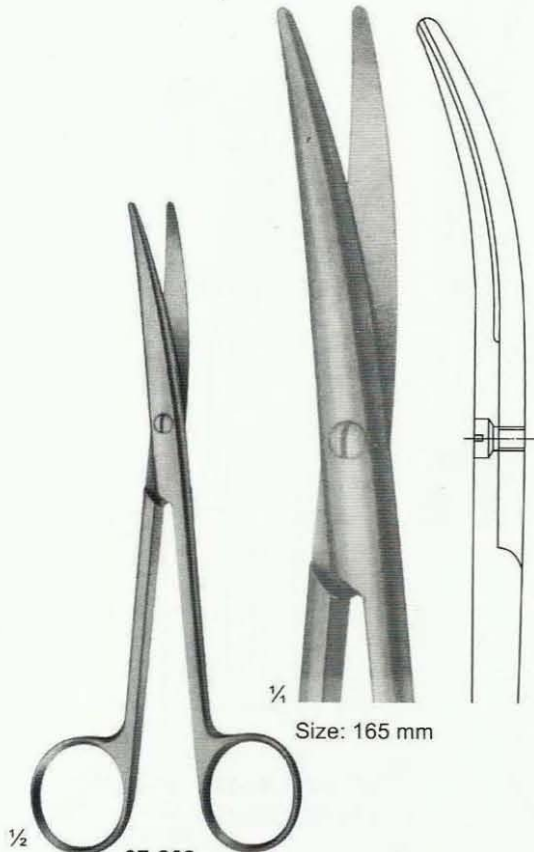

Size: 165 mm

07-262
MAYO-LEXER
Standard

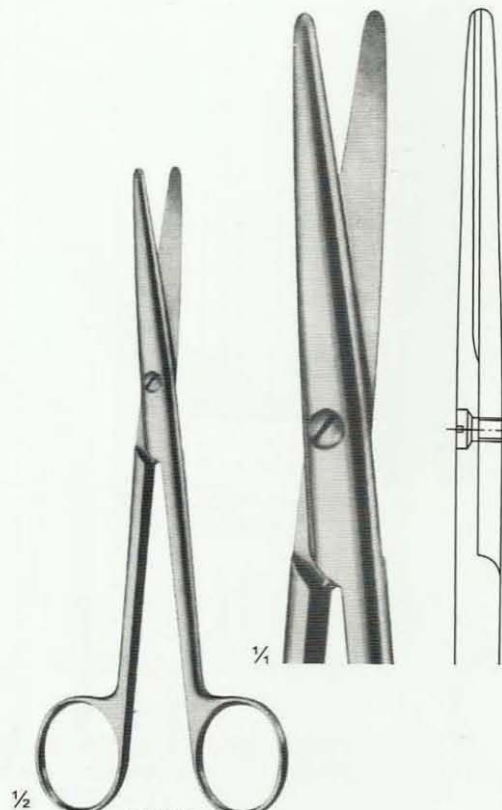

MAYO
07-263 (165 mm)
07-264 (200 mm)

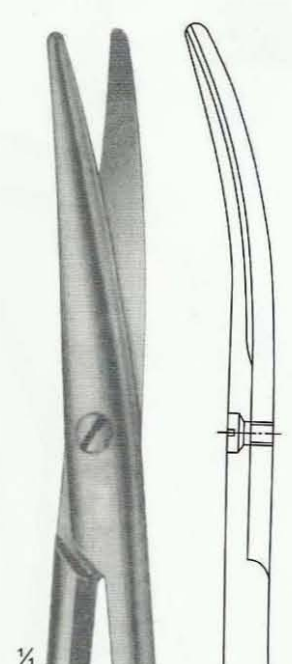

MAYO
07-265
Size: 165 mm
07-266
Size: 200 mm
07-267
Size: 210 mm

Dissecting Scissors

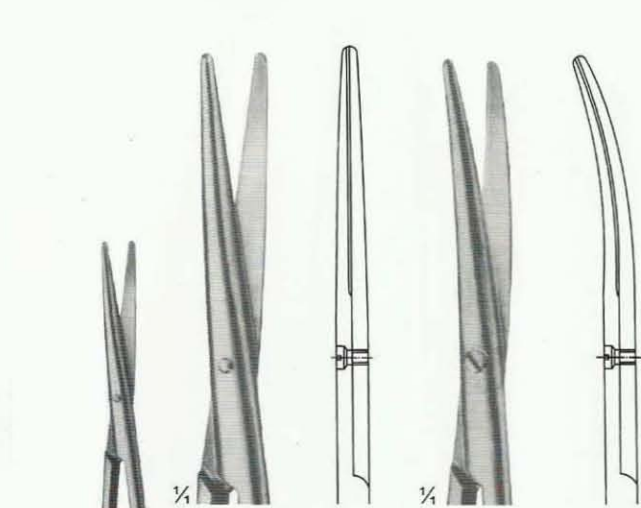

07-268
Size: 145 mm

07-269
Size: 145 mm

1/2

07-268 - 269
BABY - METZENBAUM

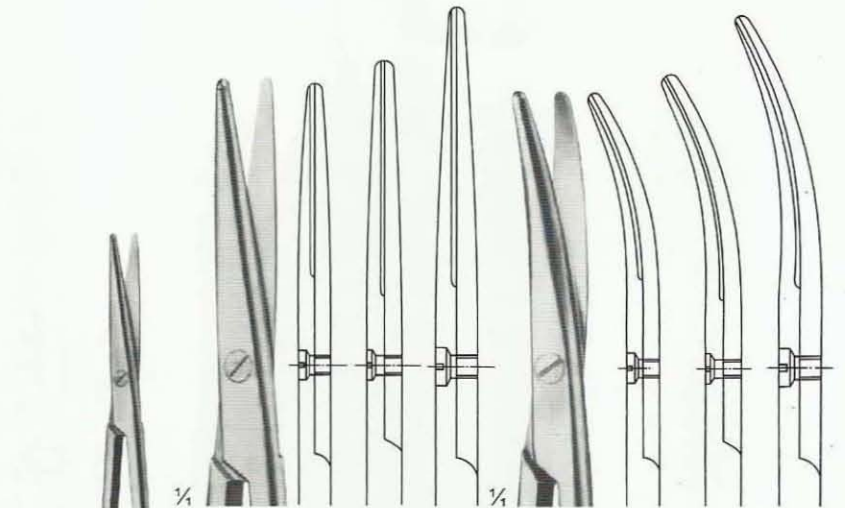

07-270
145 mm

07-271
180 mm

07-272
200 mm

07-273
145 mm

07-274
180 mm

07-275
200 mm

1/2

07-270 - 275
METZENBAUM



1/2

07-276 - 283
NELSON - METZENBAUM

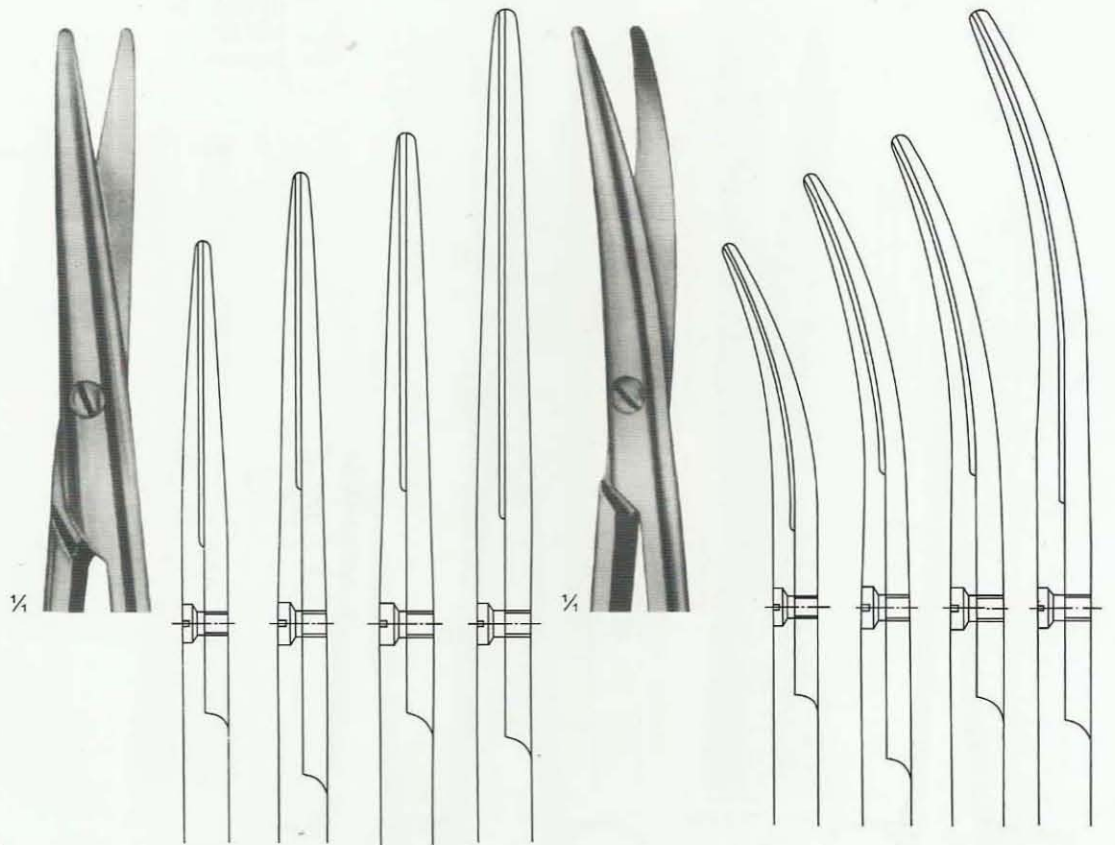

07-276
230 mm

07-277
250 mm

07-278
280 mm

07-279
305 mm

07-280
230 mm

07-281
250 mm

07-282
280 mm

07-283
305 mm

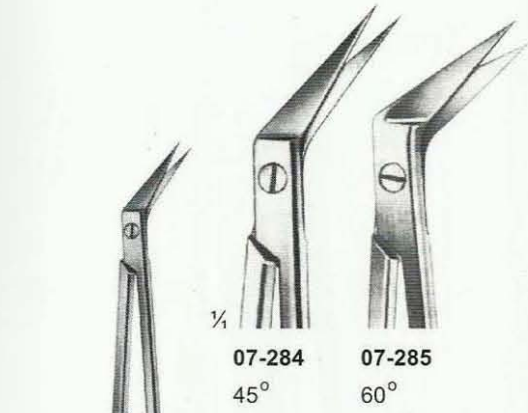

39-07-284 - 285
DE BAKLEY
Size: 155 mm

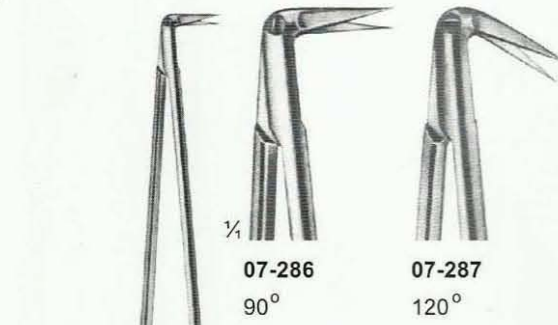

39-07-286 - 287
DIETRICH
Size: 170 mm

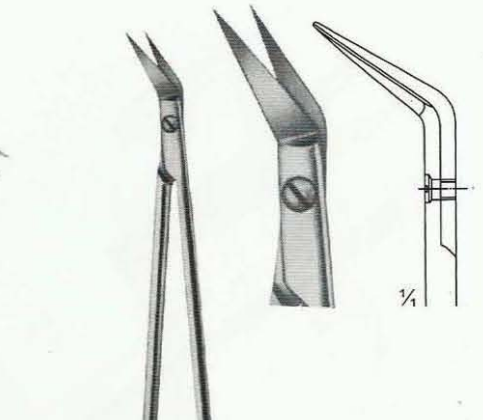

39-07-288
POTTS-SMITH
Size: 180 mm
55° Angled on Flat

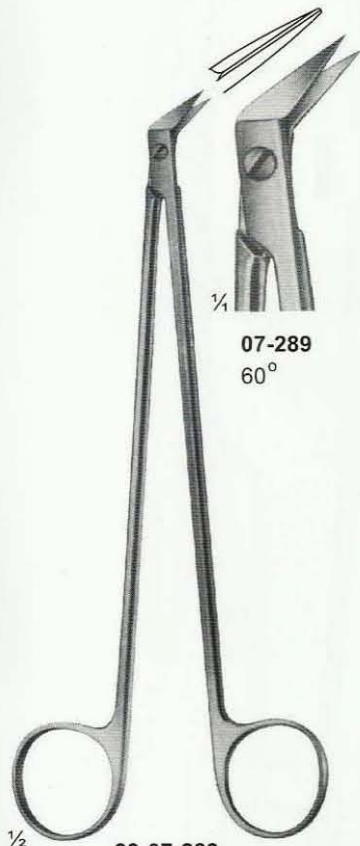

39-07-289
POTTS-SMITH
Size: 180 mm

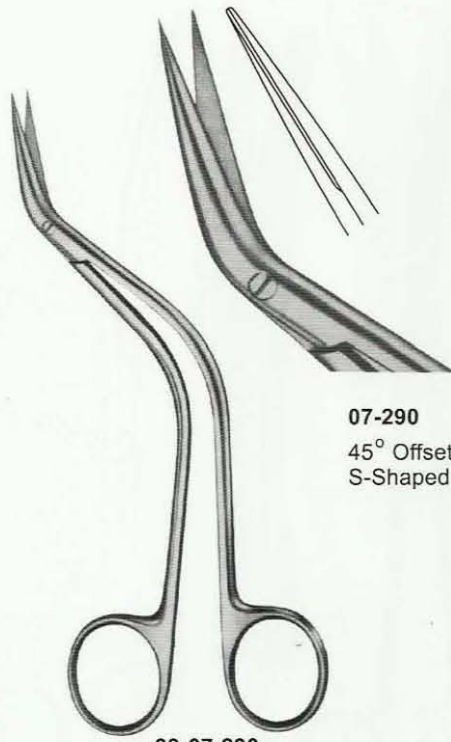

39-07-290
DEBAKEY
Size: 155 mm



39-07-291
FAVOLORO
Coronary Artery Scissors
Size: 140 mm



07-293
OLIVECRONA
Dura Scissors



07-294
STRULLY
Pointed
Size: 220 mm



07-295
STRULLY
Probe Pointed
Size: 220 mm

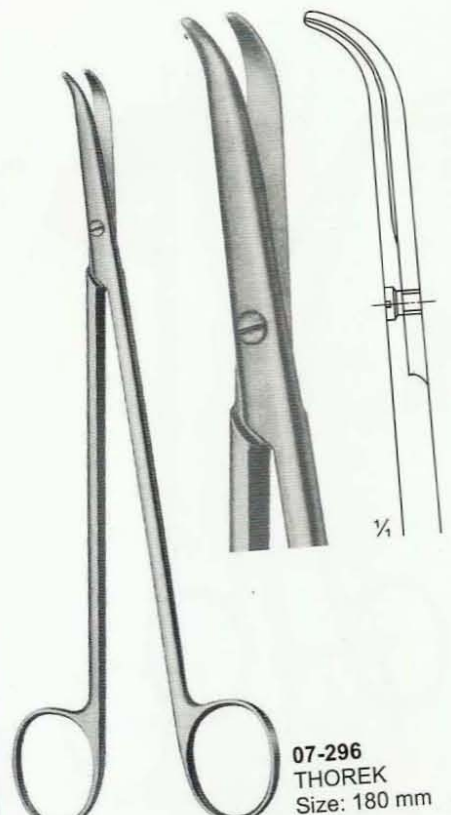

07-296
THOREK
Size: 180 mm

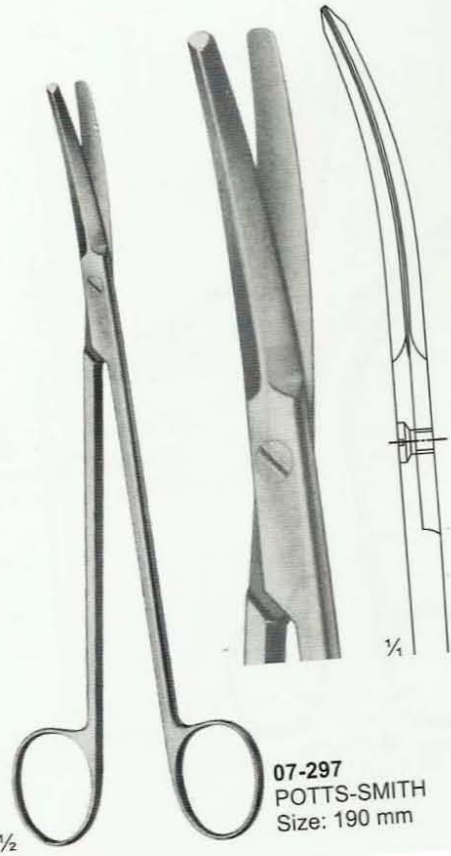

07-297
POTTS-SMITH
Size: 190 mm

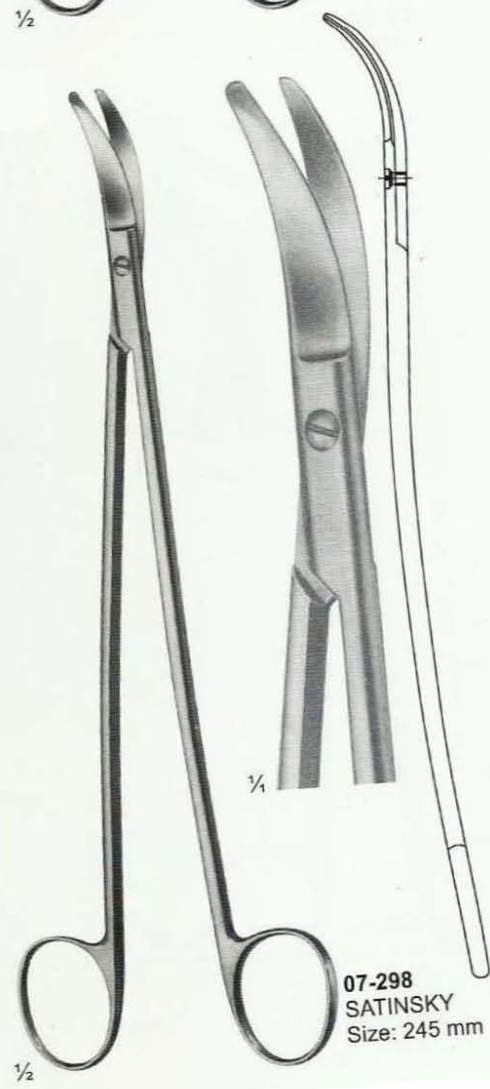

07-298
SATINSKY
Size: 245 mm

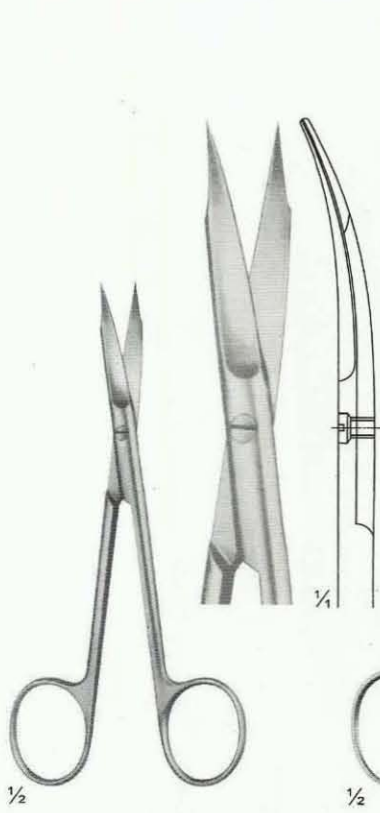

07-299
1 Finely Toothed Blade
Size: 130 mm

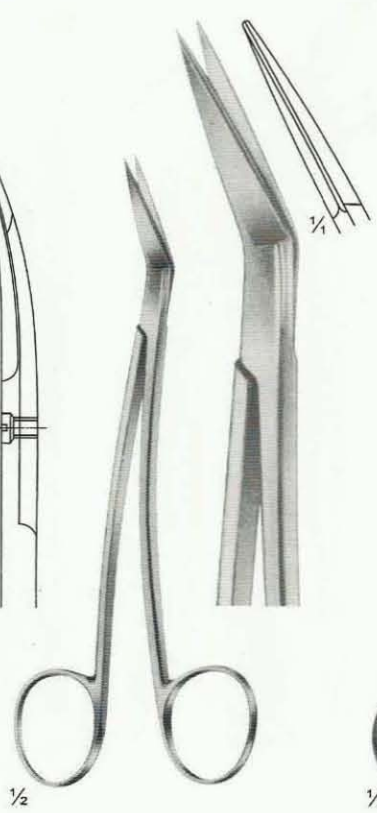

07-300
LOCKLIN
Curved Sideways,
1 Toothed Blade
Size: 155 mm

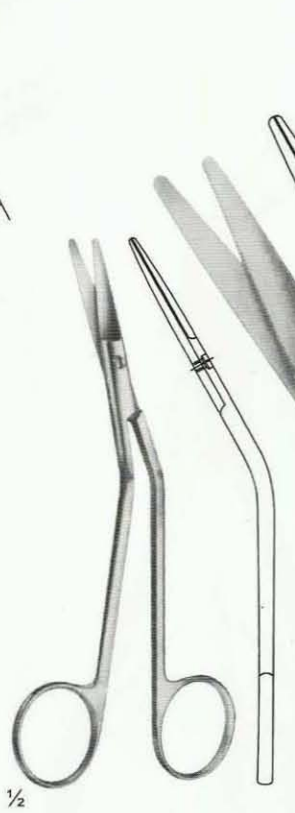

07-301
FOMON
Blades Serrated
Size: 145 mm

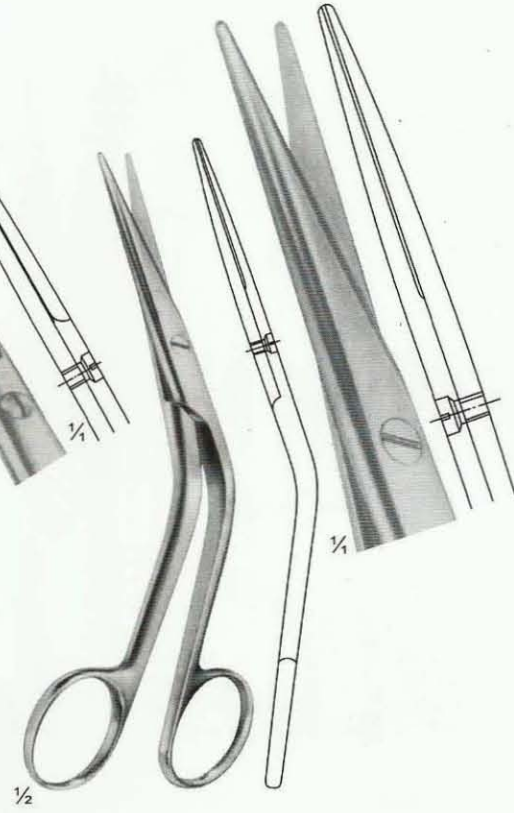

07-302
COTTLE
Size: 165 mm

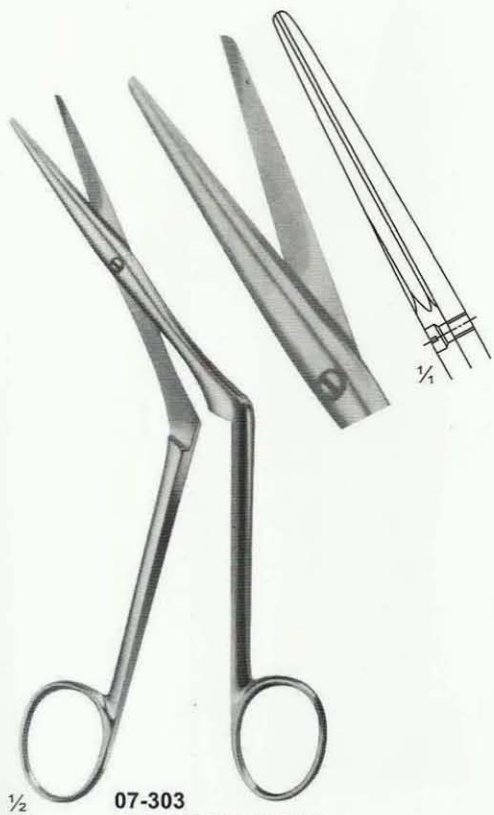

07-303
HEYMANN-KNIGHT
Size: 175 mm

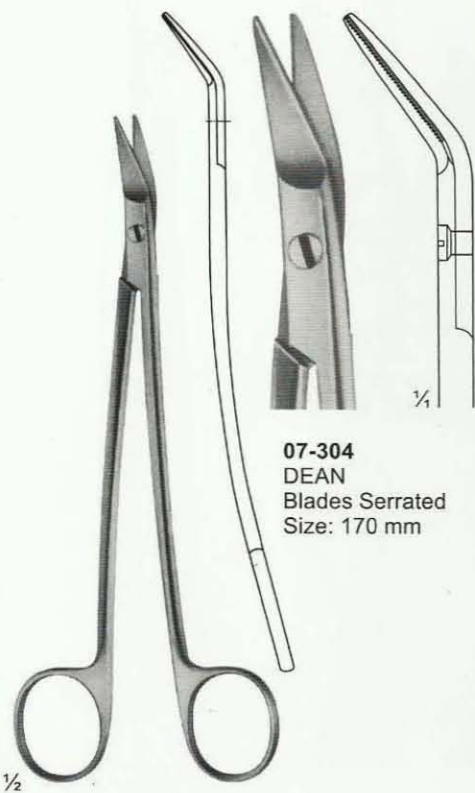

07-304
DEAN
Blades Serrated
Size: 170 mm

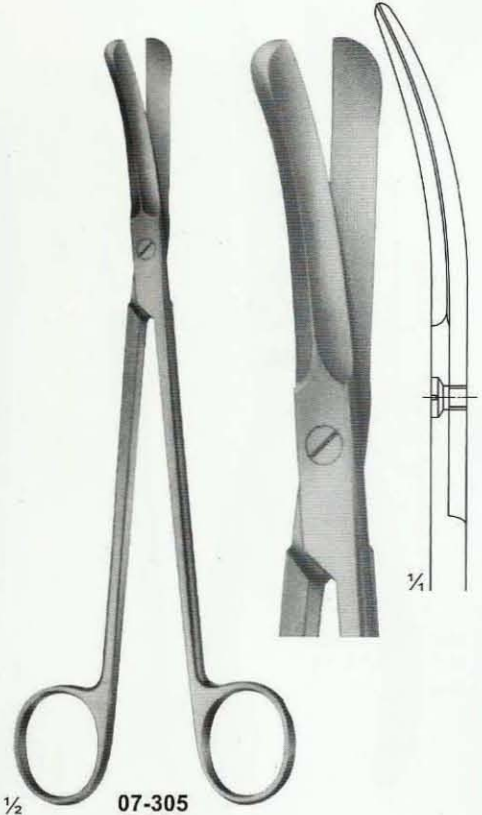

07-305
GOOD
Size: 195 mm

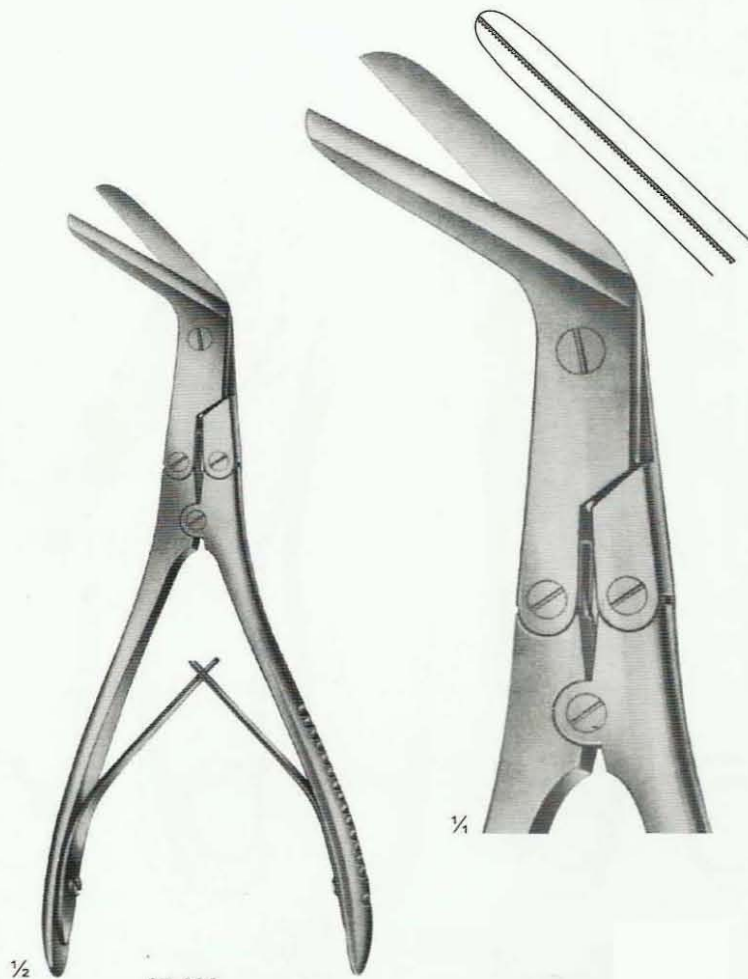

07-306
KILLIAN
Size: 200 mm



07-307 - 308



07-307
195 mm

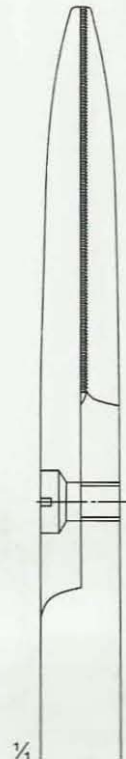

07-308
225 mm

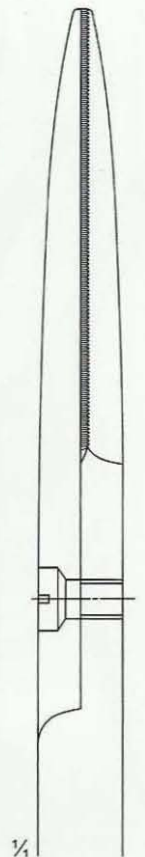

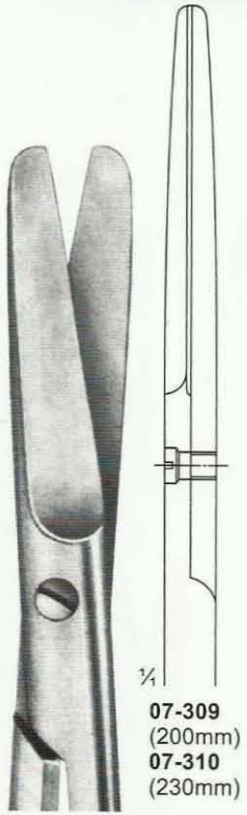

07-309
(200mm)
07-310
(230mm)

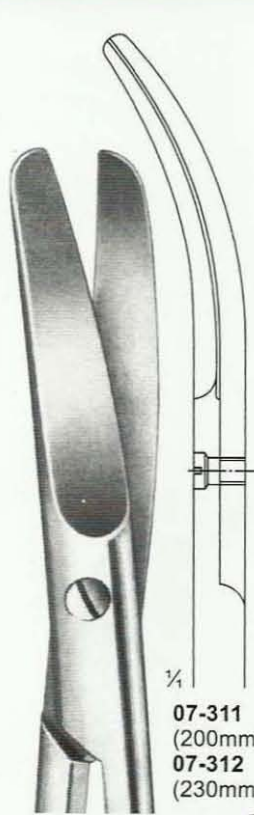

07-311
(200mm)
07-312
(230mm)

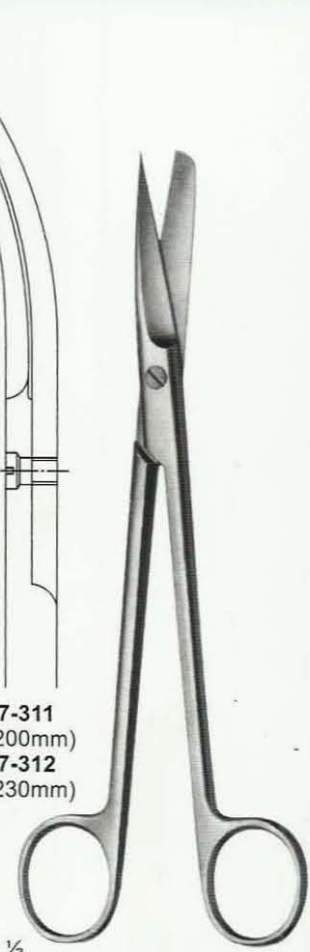

07-313
(200mm)
07-314
(230mm)

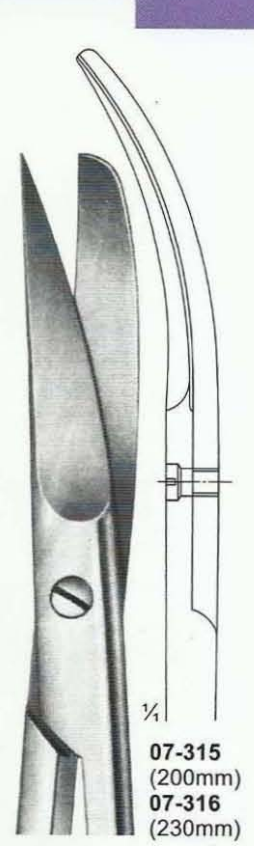

07-315
(200mm)
07-316
(230mm)

1/2
07-309 - 312
SIMS

1/2
07-313 - 316
SIMS

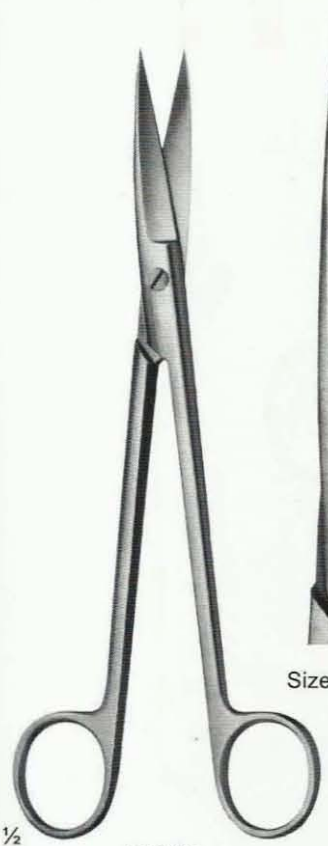

Size: 200 mm

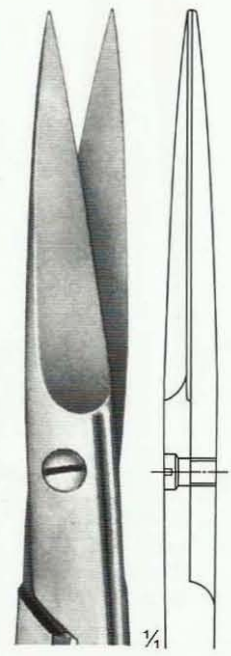

Size: 210 mm

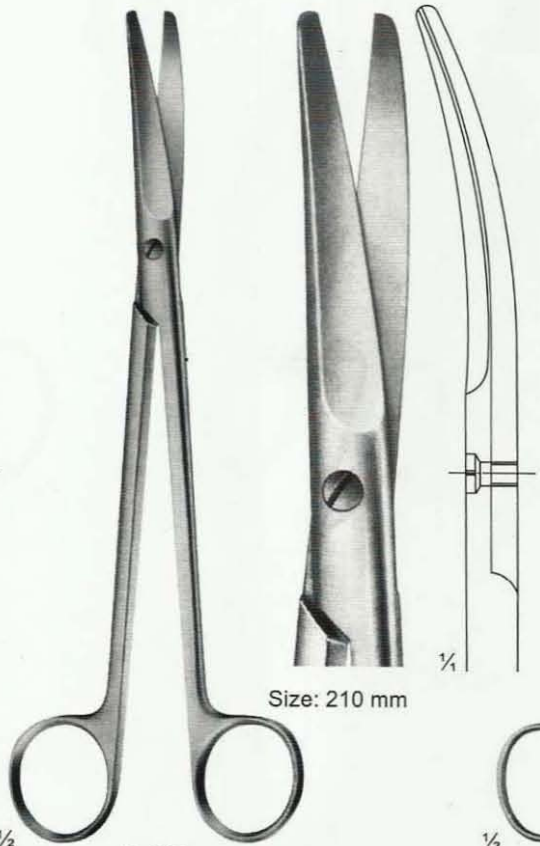

07-319 145 mm
07-320 200 mm
07-321 230 mm

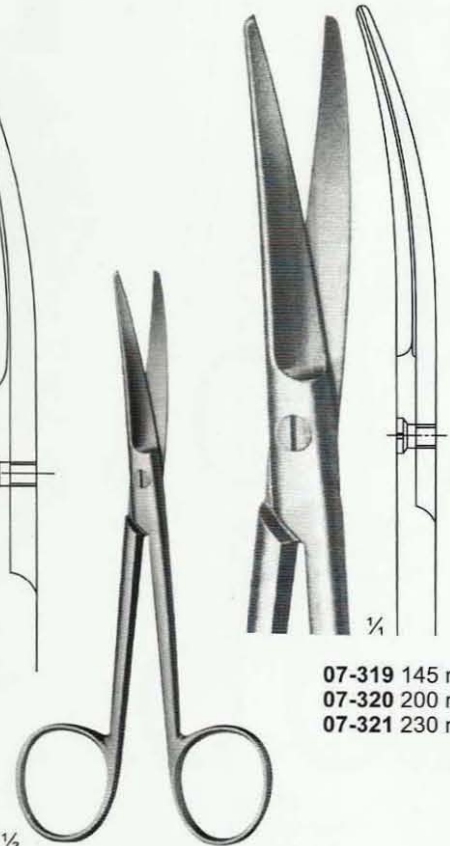

07-319 - 321
WERTHEIM

1/2
07-317
SIMS

1/2
07-318
SIMS

1/2
07-319 - 321
WERTHEIM

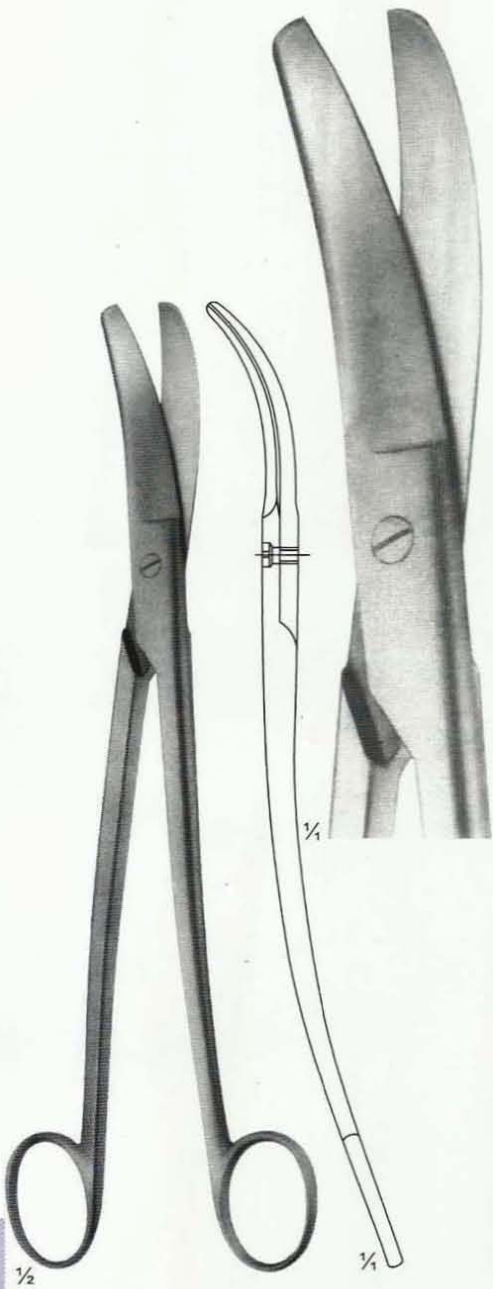

07-322
SIEBOLD
 Uterine Scissors
 Size: 245 mm

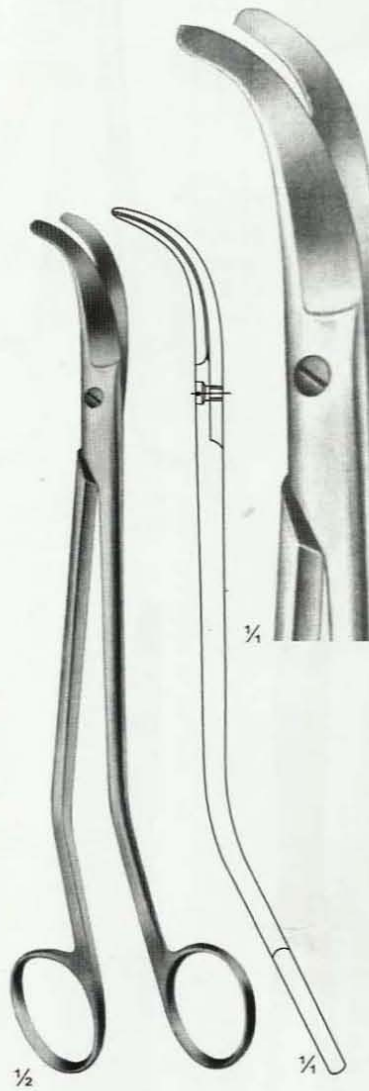

07-323
BOZEMANN
 Uterine Scissors
 Size: 220 mm

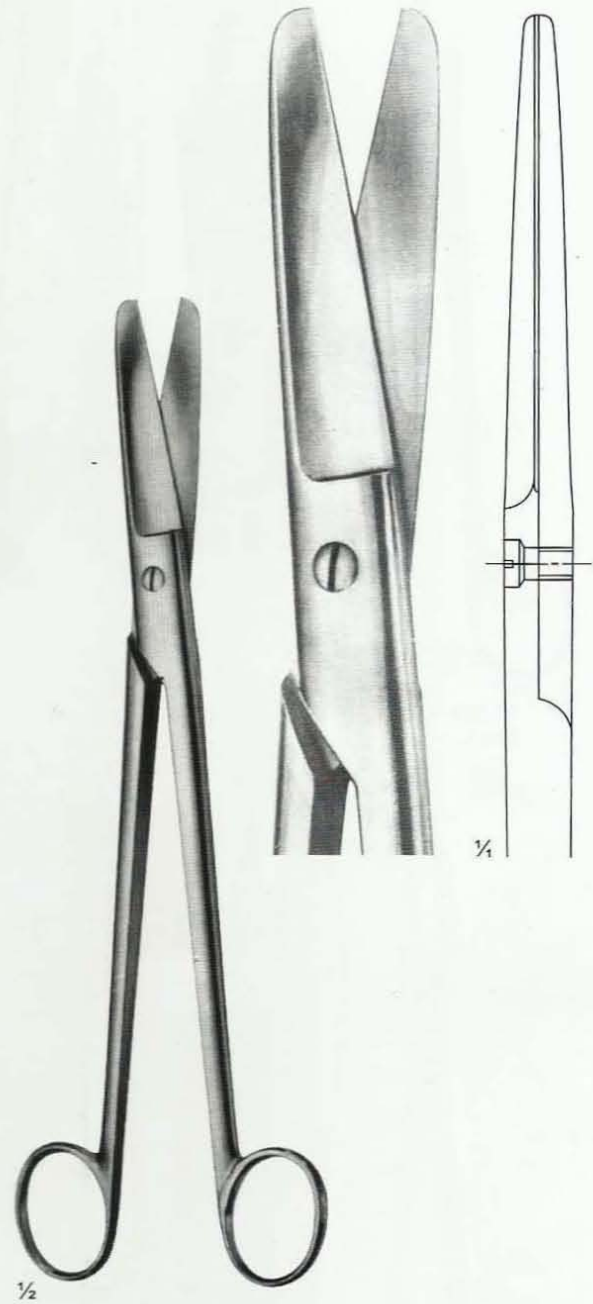

07-324
SIMS-SIEBOLD
 Uterine Scissors
 Size: 250 mm

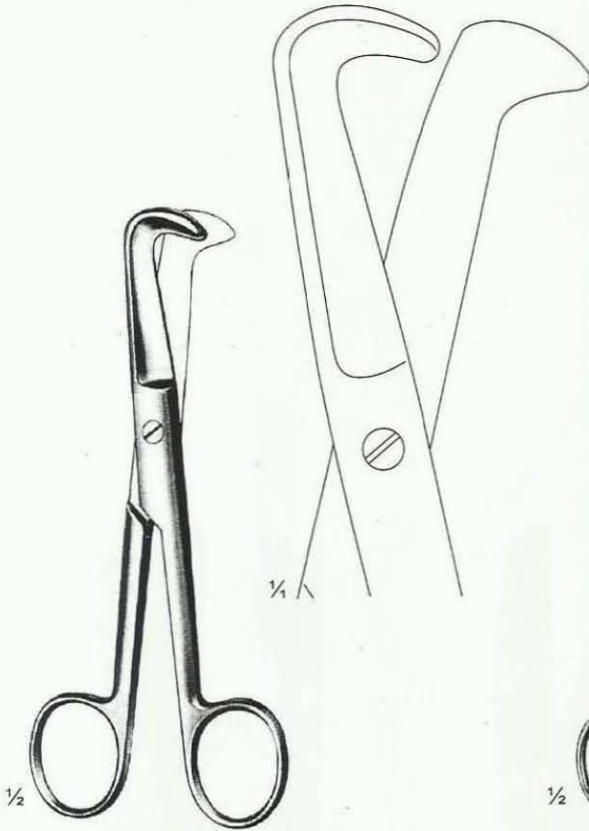

07-325
SCHUMACHER
 Umbilical Cord Scissors
 Size: 155 mm

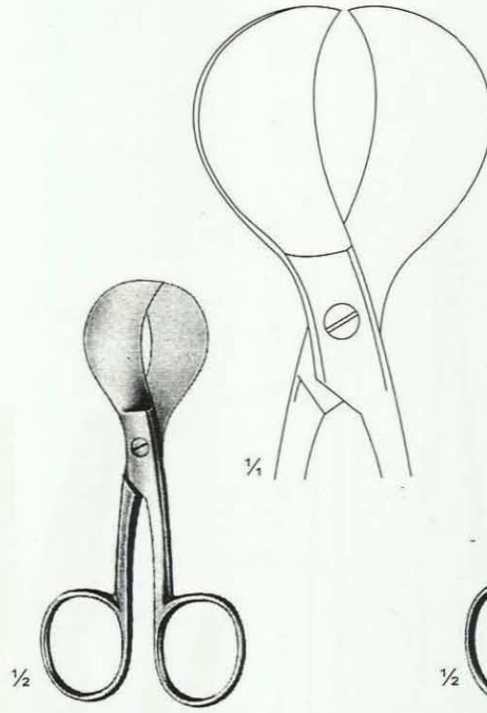

07-326
 Umbilical Cord Scissors
 Size: 105 mm

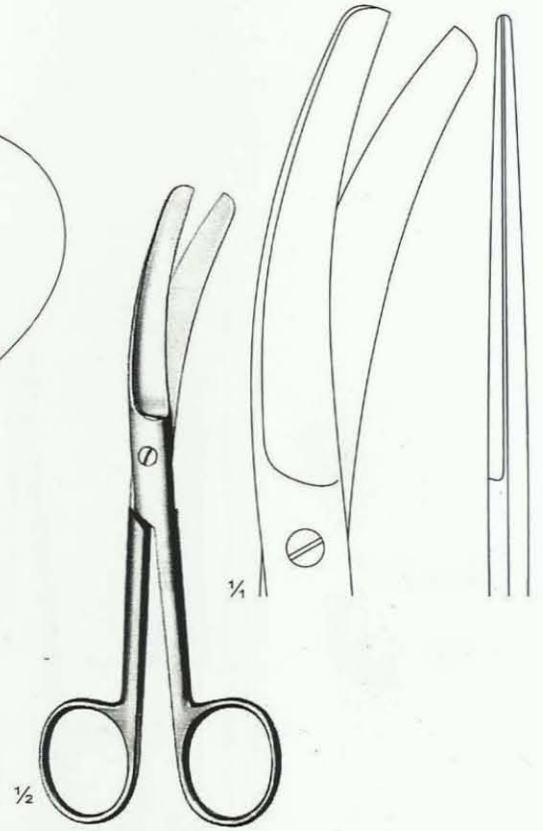

07-327
 Umbilical
 Cord Scissors
 135 mm



BRAUN-STADLER
07-328
 14.5 cm / 5 1/2"
07-329
 18 cm / 7 1/4"

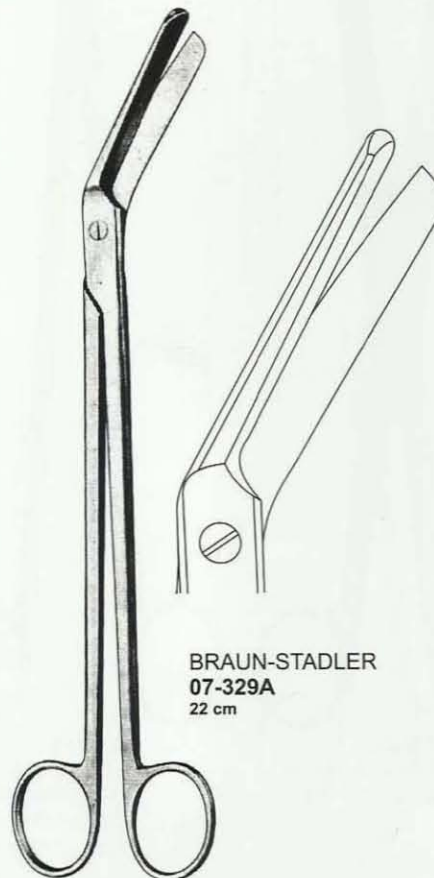

BRAUN-STADLER
07-329A
 22 cm

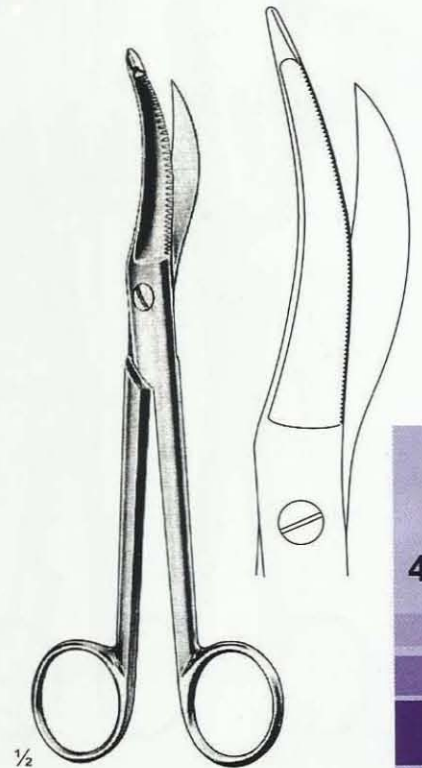

07-330
 EPISIOTOMY
 SCISSORS
 240 mm

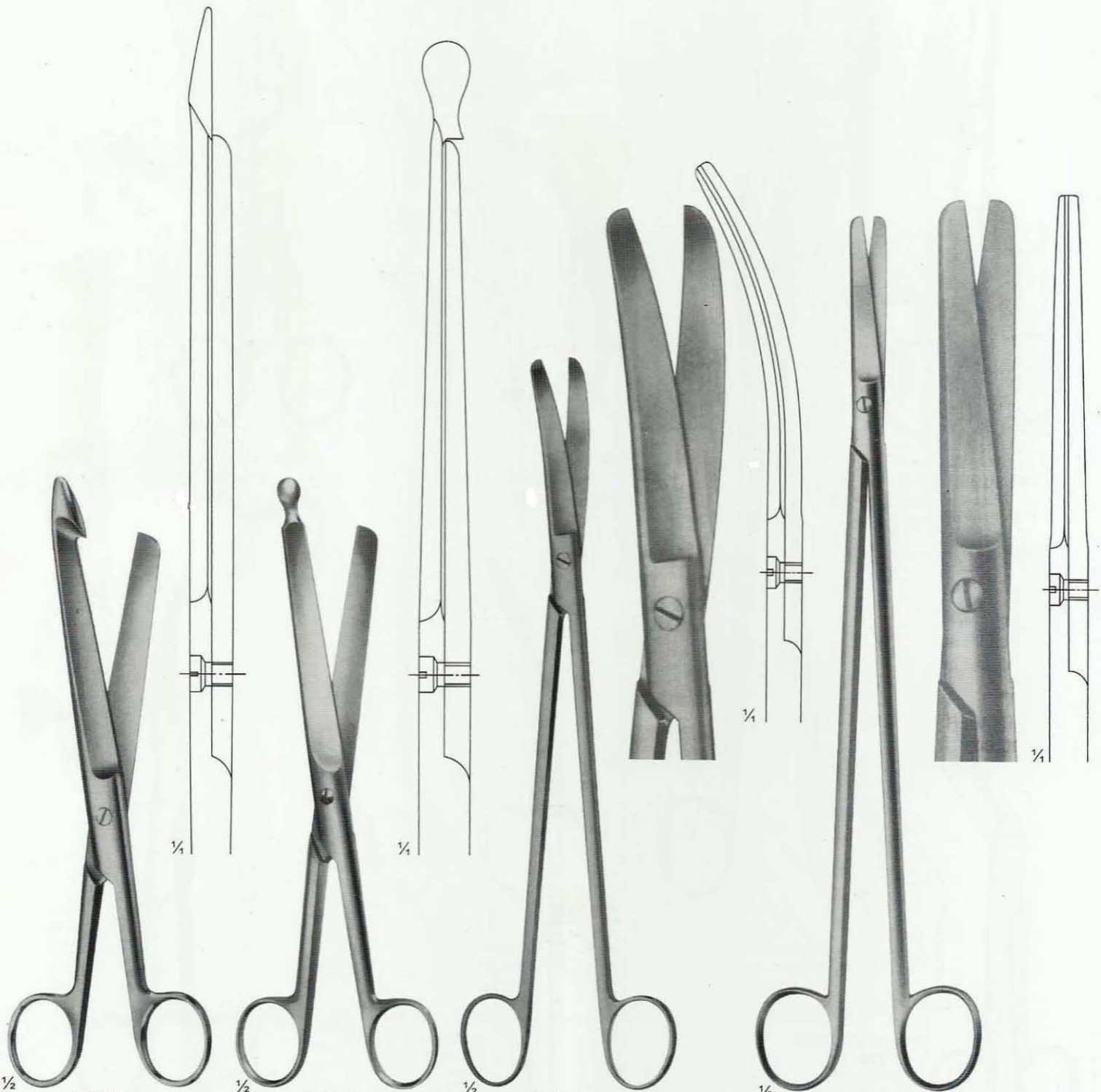

07-331
Bowel Scissors
Size: 210 mm

07-332
Bowel Scissors
Size: 210 mm

07-333
LLOYD-DAVIES
(GOLIGHER'S)
Rectal Scissors
Size: 270 mm

07-334
STELZNER
Rectal Scissors
Size: 310 mm



07-335 - 336
SPENCER

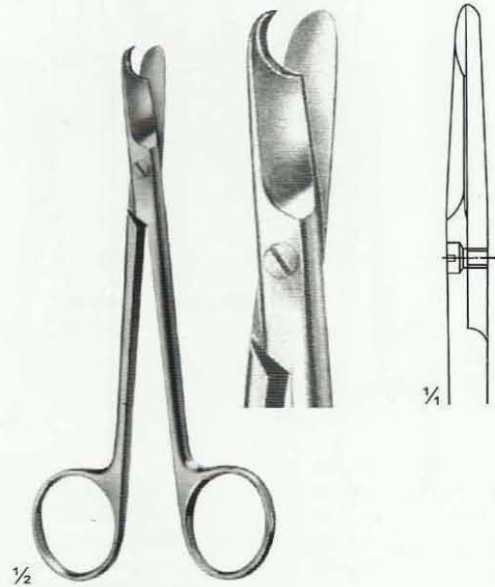

07-337
LITTAUER
Size: 135 mm

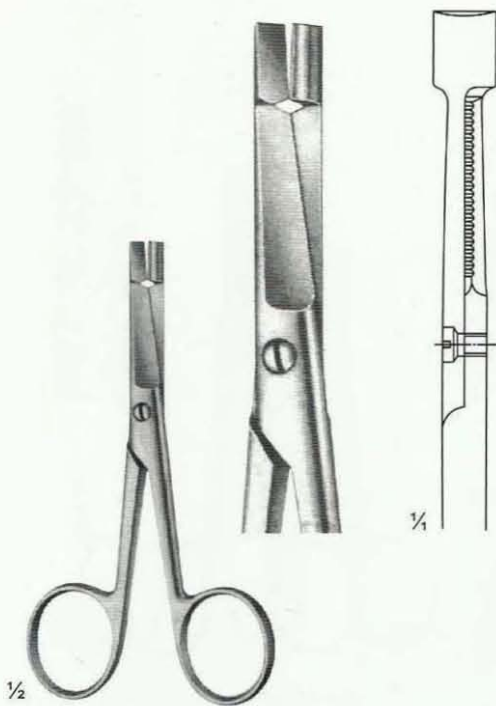

07-338
EISELSBERG
Size: 115 mm

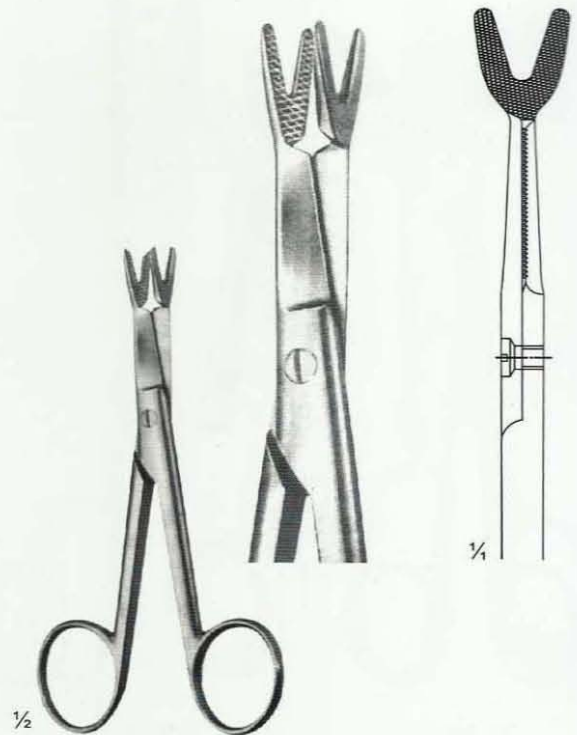

07-339
SCHOEMAKER-LOTH
Size: 125 mm

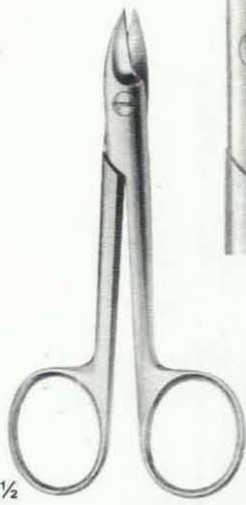

07-340 - 344
BEEBE
Size: 110 mm

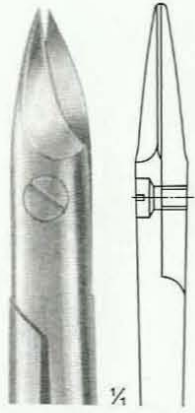

07-340

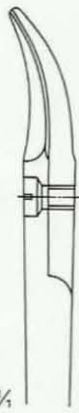

07-341

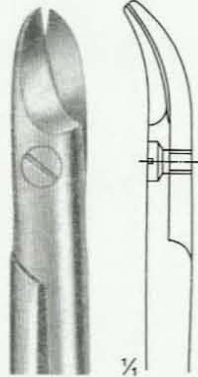

07-342
Broad Blades

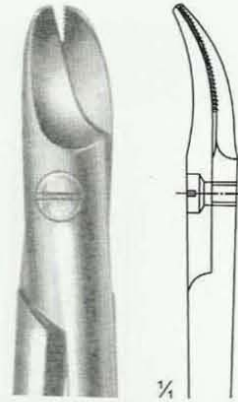

07-343
1 Blade Serrated

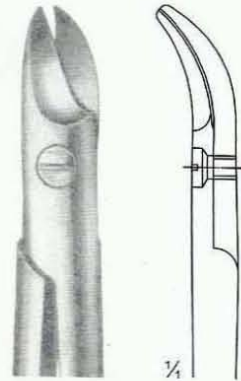

07-344
NAUJOKS
Strongly Curved

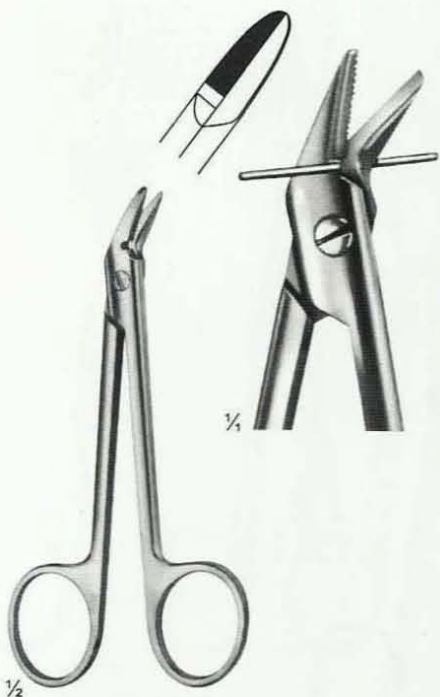

07-345
1 Blade Serrated
Size: 120 mm



07-346
STRACK
Size: 100 mm

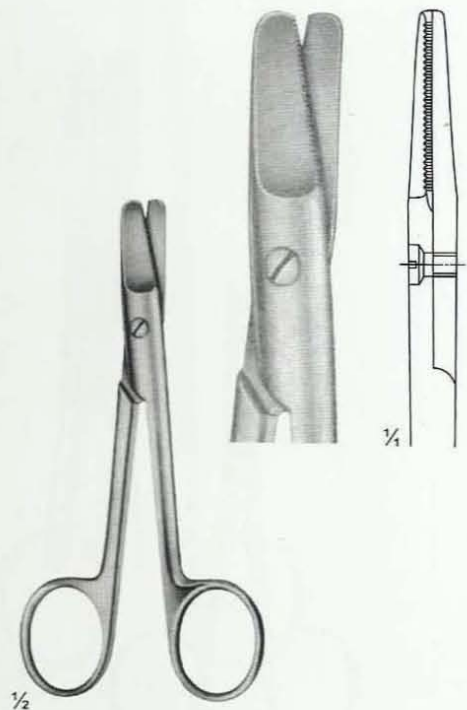

07-347
HARVEY
blades serrated
Size: 125 mm



07-348
NAIL SCISSORS
Size: 90 mm

07-349
NAIL SCISSORS
especially fine pattern
Size: 90 mm

07-350
BABY NAIL
SCISSORS
Size: 85 mm

07-351 - 354
NAIL SCISSORS
07-351 (90mm) str
07-352 (90mm) cvd
07-353 (100mm) str
07-354 (110mm) cvd

07-355 - 357
NAIL SCISSORS
07-355 (95mm) str
07-356 (95mm) cvd
07-357 (105mm) str

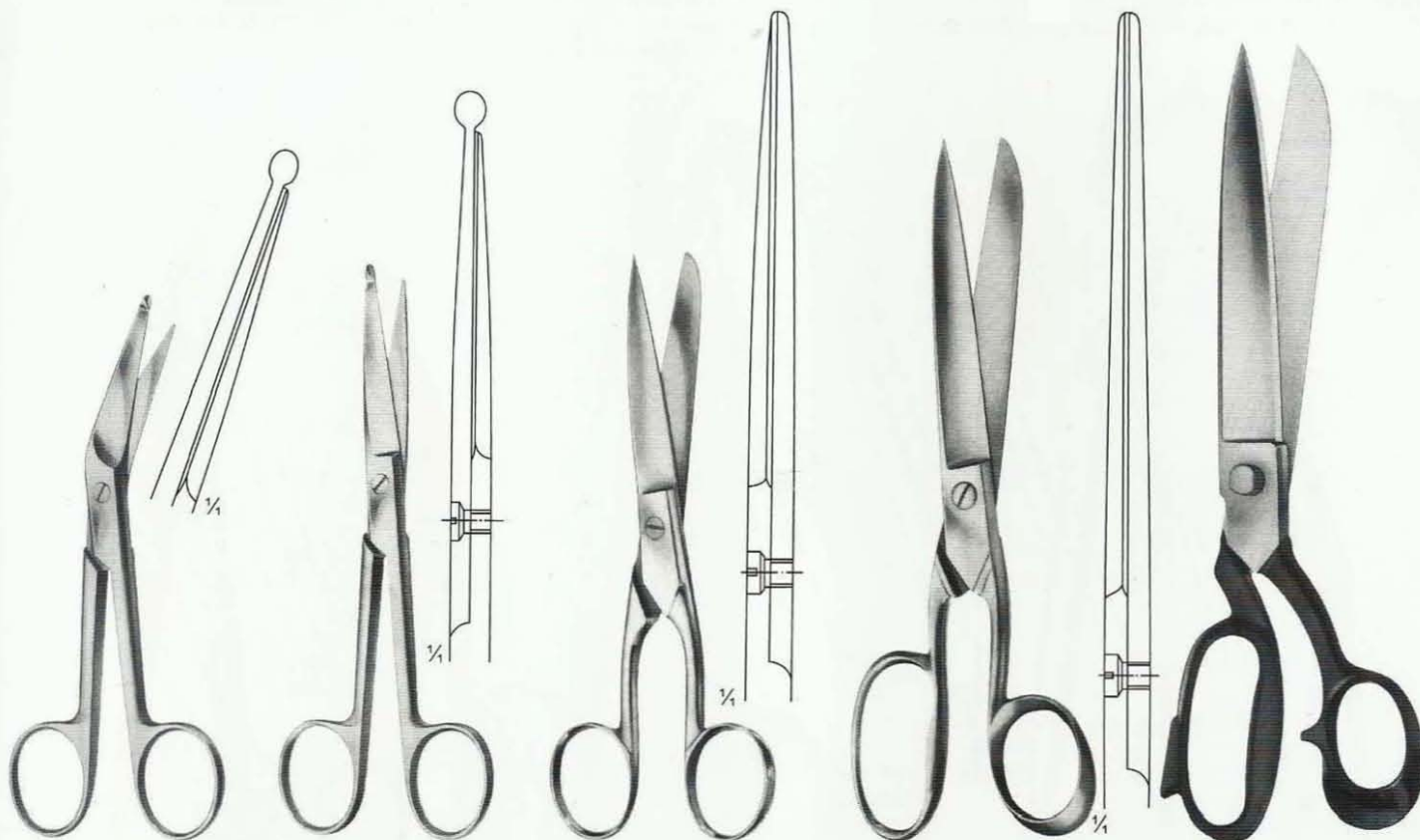

07-358
KNOWLES
Size: 140 mm

07-359
KNOWLES
Size: 145 mm

07-360
Size: 150 mm

07-361
SMITH
Size: 180 mm

07-362
BANDAGE CUTTING
SCISSORS
Size: 310 mm



07-363
UNIVERSAL BANDAGE & CLOTH SCISSORS,
WITH TOOTHED EDGES, AUTO CLEAVABLE up to 143 °C
180 mm

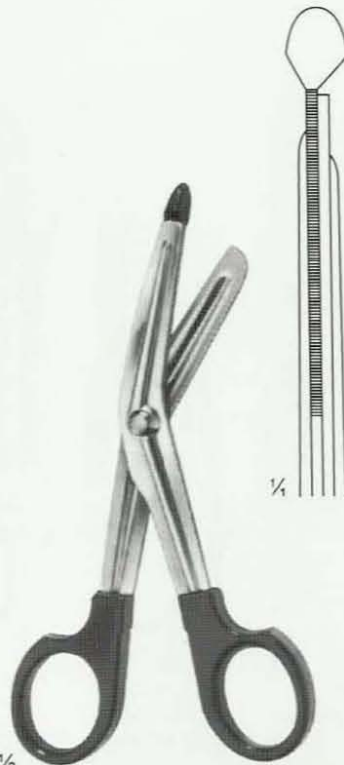

07-364
LISTER BANDAGE & CLOTH
SCISSORS, WITH TOOTHED EDGES,
AUTO CLEAVABLE up to 143 °C
Size: 145 mm

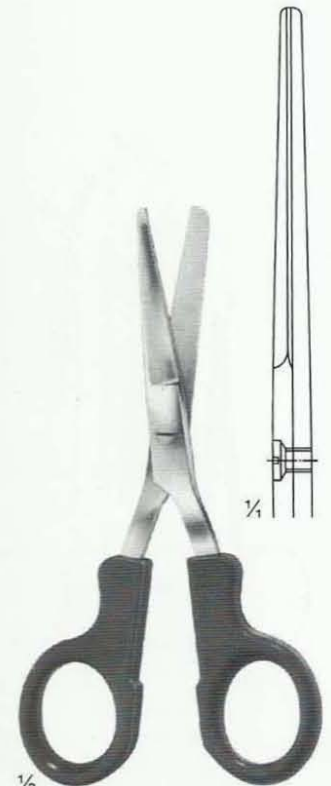

07-365
NURSE'S SCISSORS
Size: 145 mm
AUTO CLEAVABLE up to 143 °C

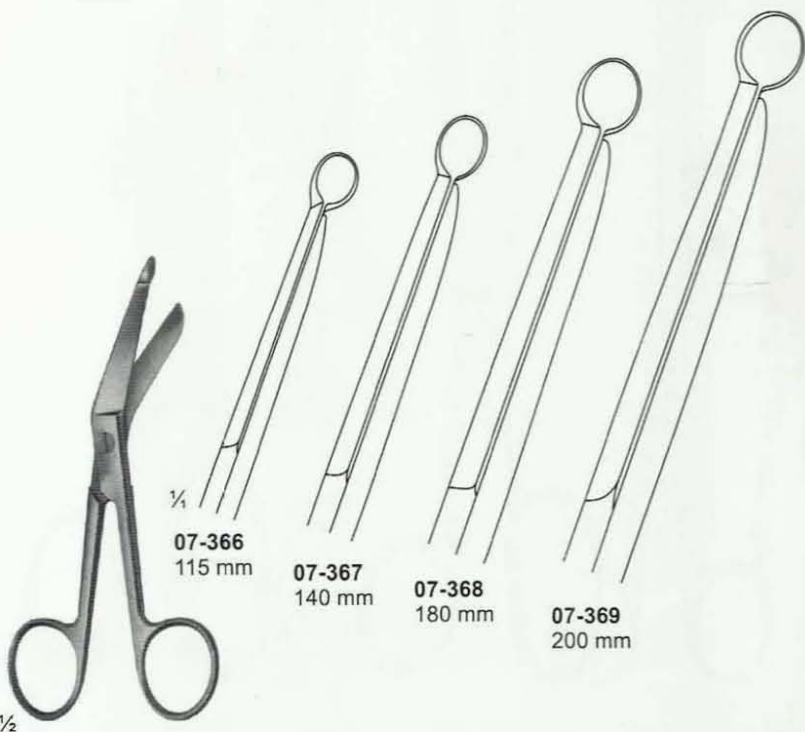

07-366 - 369
LISTER

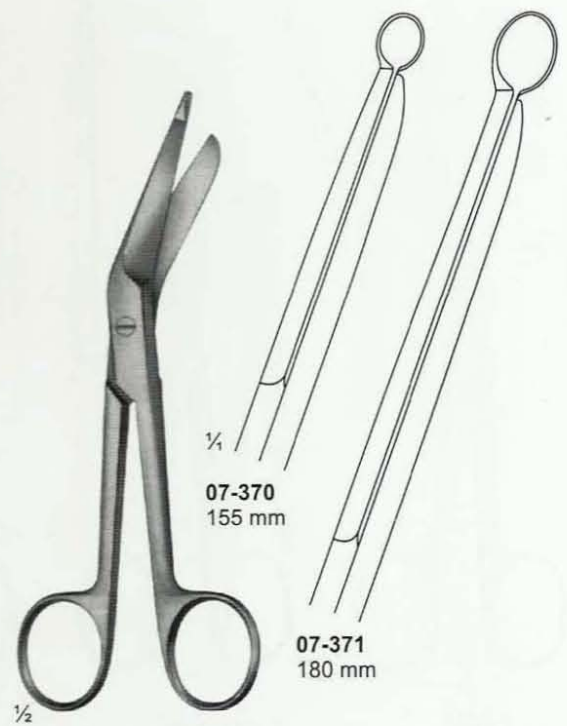

07-370 - 371
LISTER



07-372
CLOTH SCISSORS
205 mm

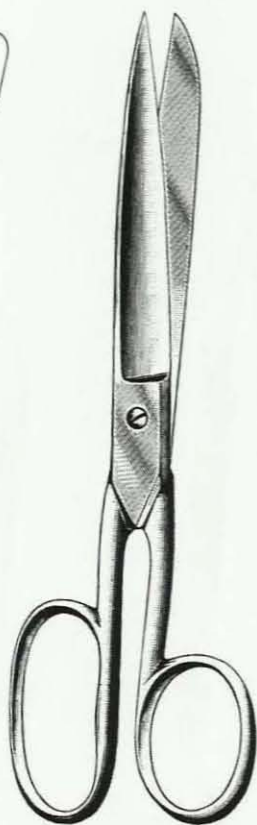
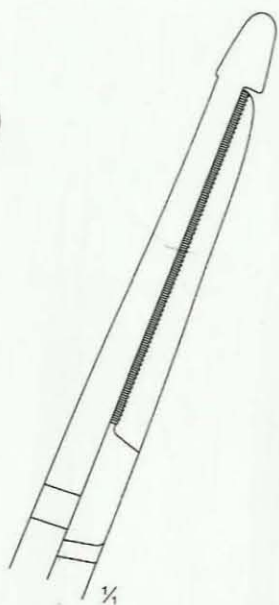

07-373
SMITH
(Mod. USA)
20 cm



07-374
SEUTIN
Plaster scissors
230 mm

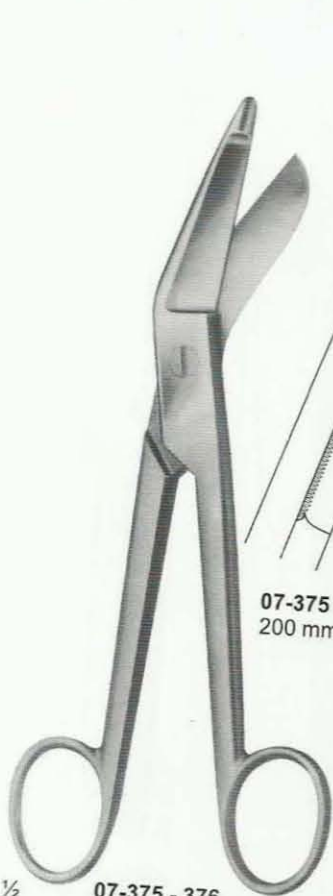
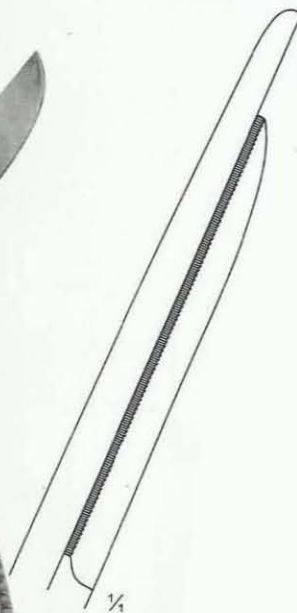

07-375 - 376
ESMARCH (Plaster scissors)

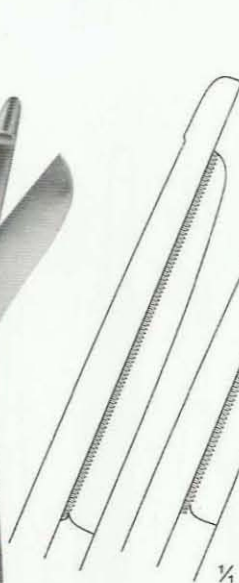

07-375
200 mm

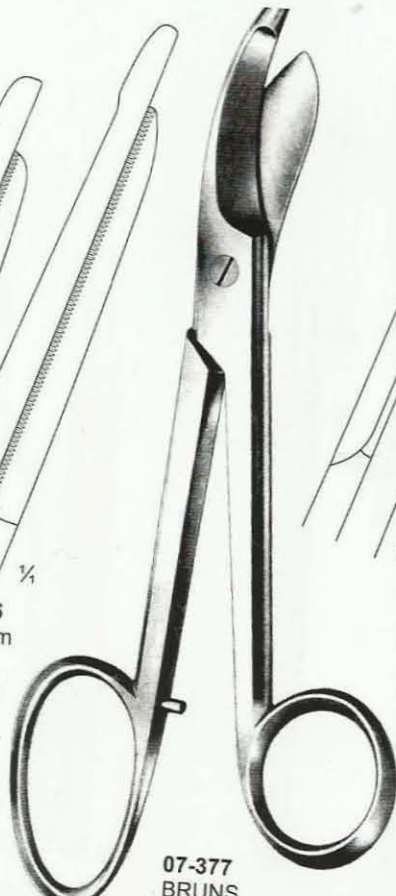

07-377
BRUNS
Plaster scissors
235 mm



07-378
BANDAGE SCISSORS
235 mm

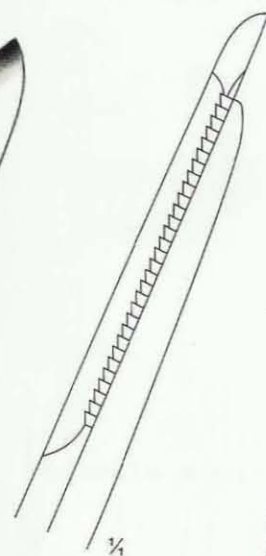

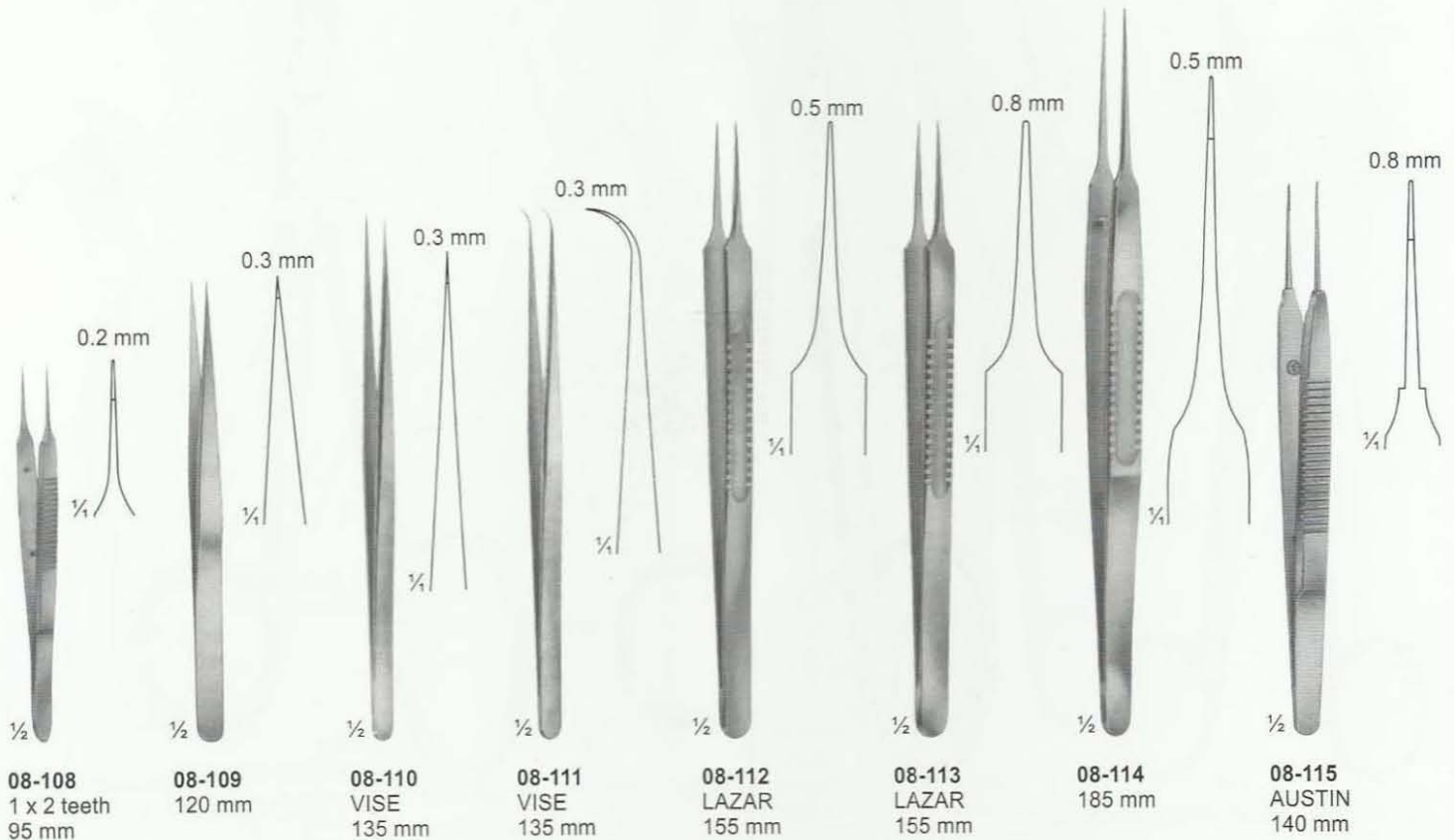
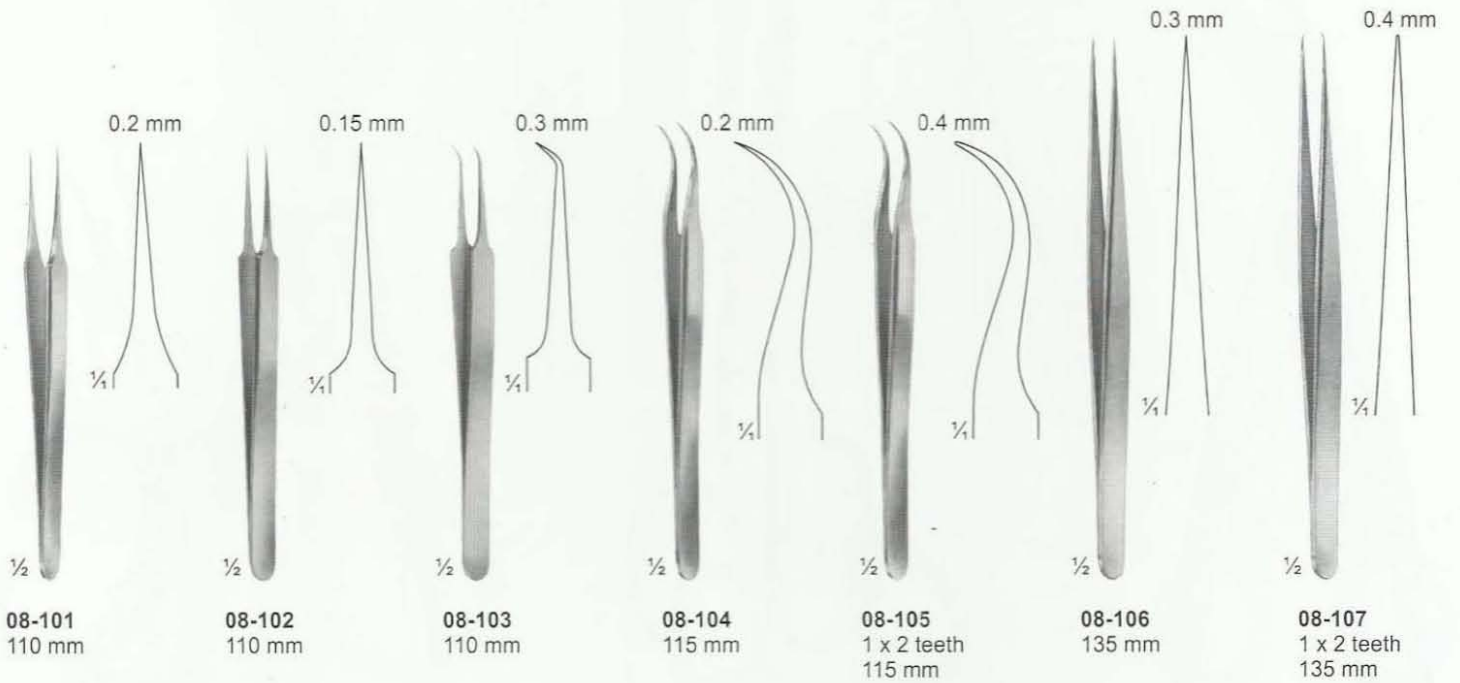

Micro Forceps, Ligature Forceps
(Light Patterns), Bayonet - Shaped

0.15 mm 0.20 mm 0.30 mm 0.50 mm

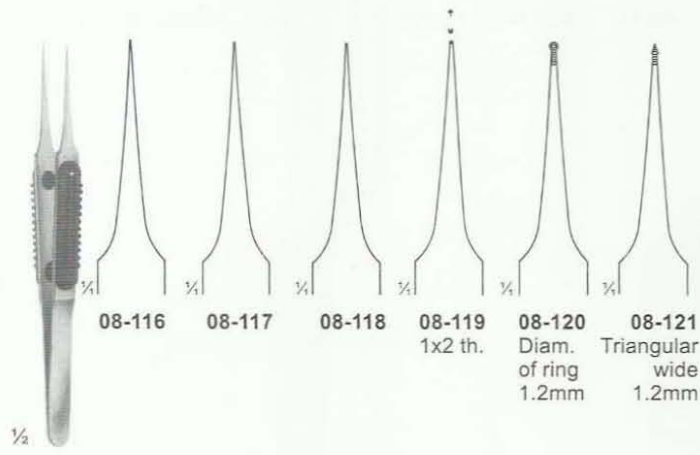

08-116 - 121
MULLER
110 mm



08-122
LIGATURE
FORCEPS
220 mm



08-123
YASARGIL
Ligature forceps
185 mm

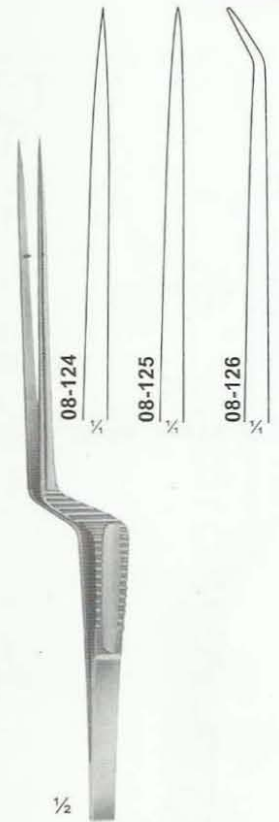

08-124 - 126
MICRO FORCEPS
Ligature pattern
185 mm

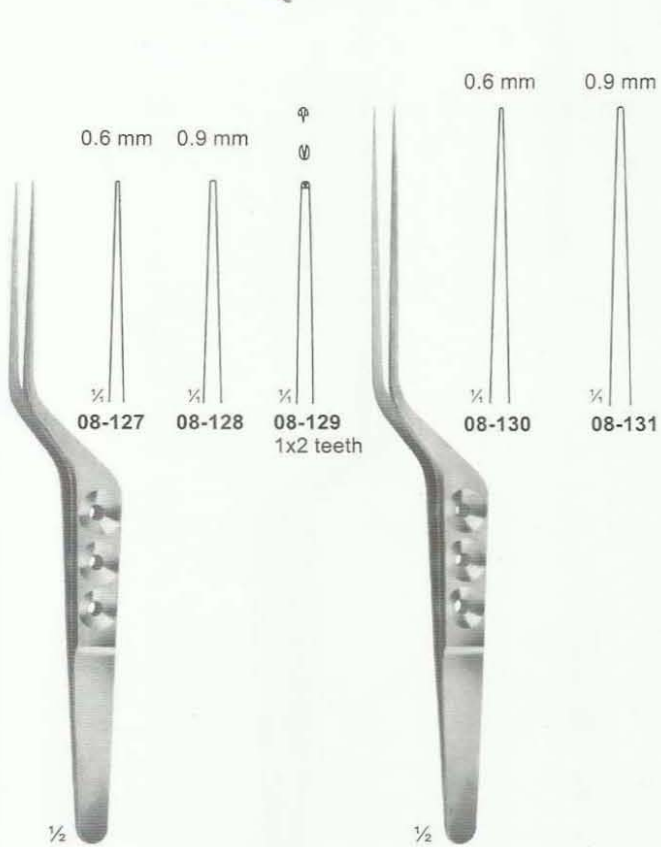

08-127 - 129
YASARGIL
180 mm

08-130 - 131
YASARGIL
200 mm



08-132 - 133
YASARGIL
220 mm

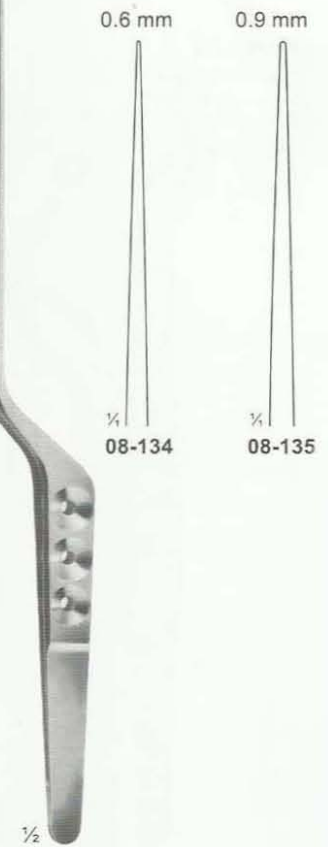

08-134 - 135
YASARGIL
240 mm

**Forceps for Grasping Tissue,
Tumors, Bayonet Shaped**



08-136 - 138
YASARGIL-SAMII
Jaws Spoon-Shaped
240 mm

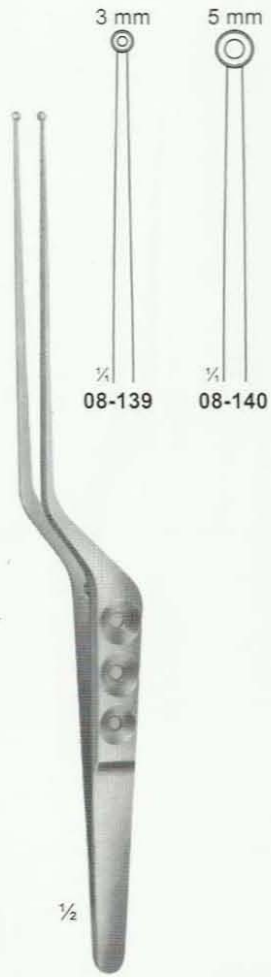

08-139 - 140
YASARGIL
Jaws Spoon-Shaped
220 mm



08-141 - 143
SAMII
Jaws Spoon-Shaped
230 mm



08-144 - 146
SAMII
Jaws Spoon-Shaped
230 mm

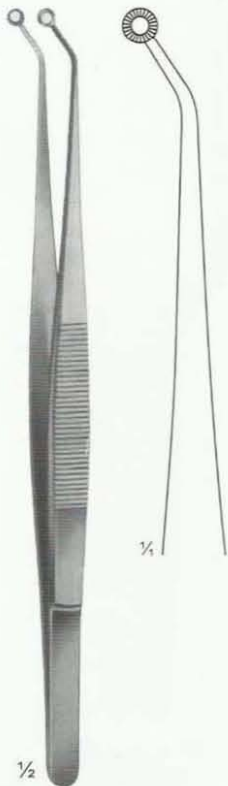

08-147
HUNT
Tumor-and Vessel Forceps

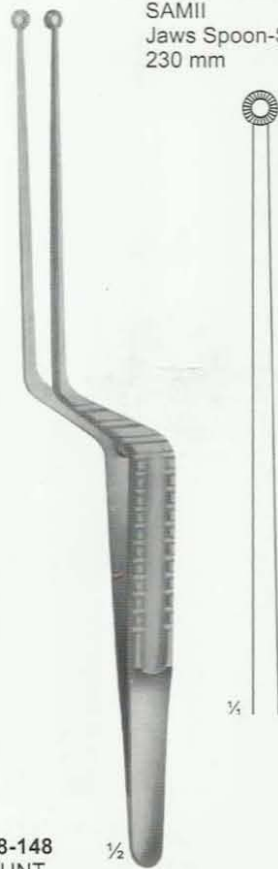

08-148
HUNT
Tumor-and Vessel Forceps

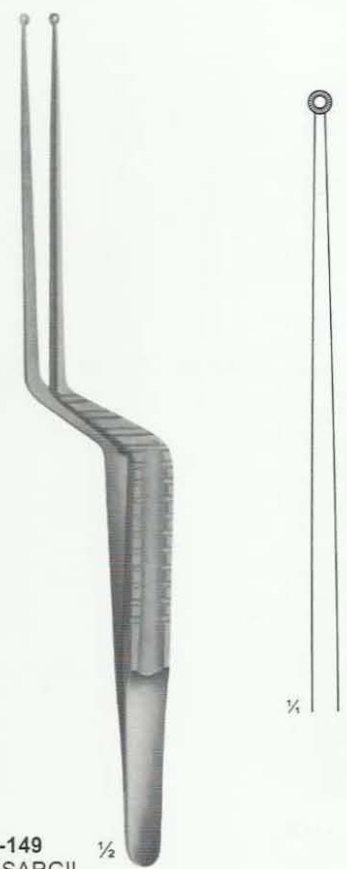

08-149
YASARGIL
Tumor-and Vessel Forceps

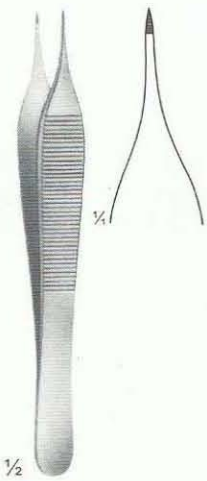

08-150
THORPE
Corneal forceps
120 mm

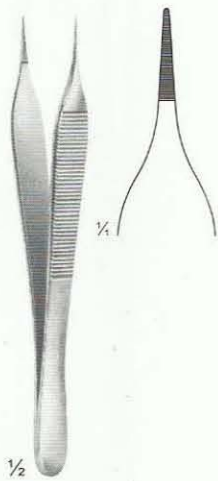

08-151
MICRO-ADSON
120 mm

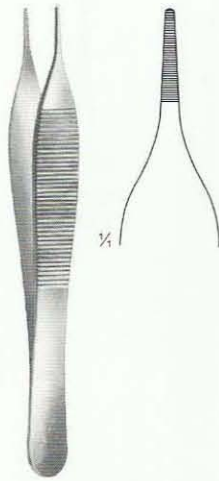

08-152
ADSON
120 mm

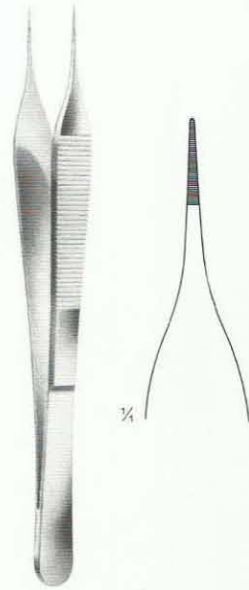

08-153
MICRO-ADSON
150 mm



08-154 - 156
100 mm



08-154



08-155



08-156

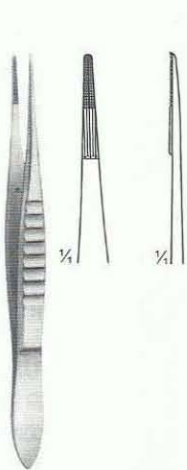

08-157
BONACCOLTO
110 mm

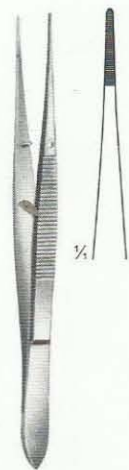

08-158
115 mm



08-159 - 168

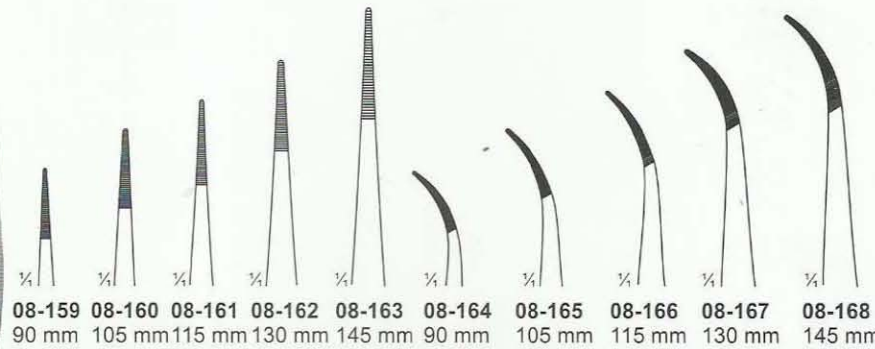

08-159 90 mm **08-160** 105 mm **08-161** 115 mm **08-162** 130 mm **08-163** 145 mm **08-164** 90 mm **08-165** 105 mm **08-166** 115 mm **08-167** 130 mm **08-168** 145 mm



DAVIS
08-173 16 cm
08-173A 20 cm
08-173B 24 cm



08-169
100 mm

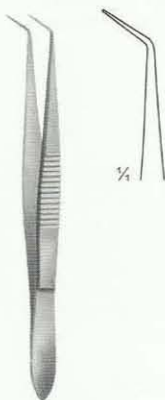

08-170
100 mm

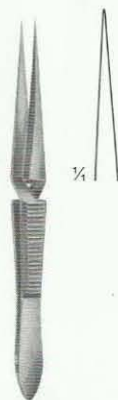

08-171
100 mm

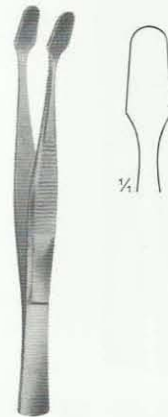

08-172
KUHNE
Cover glass forceps
105 mm

Delicate Dissecting Forceps

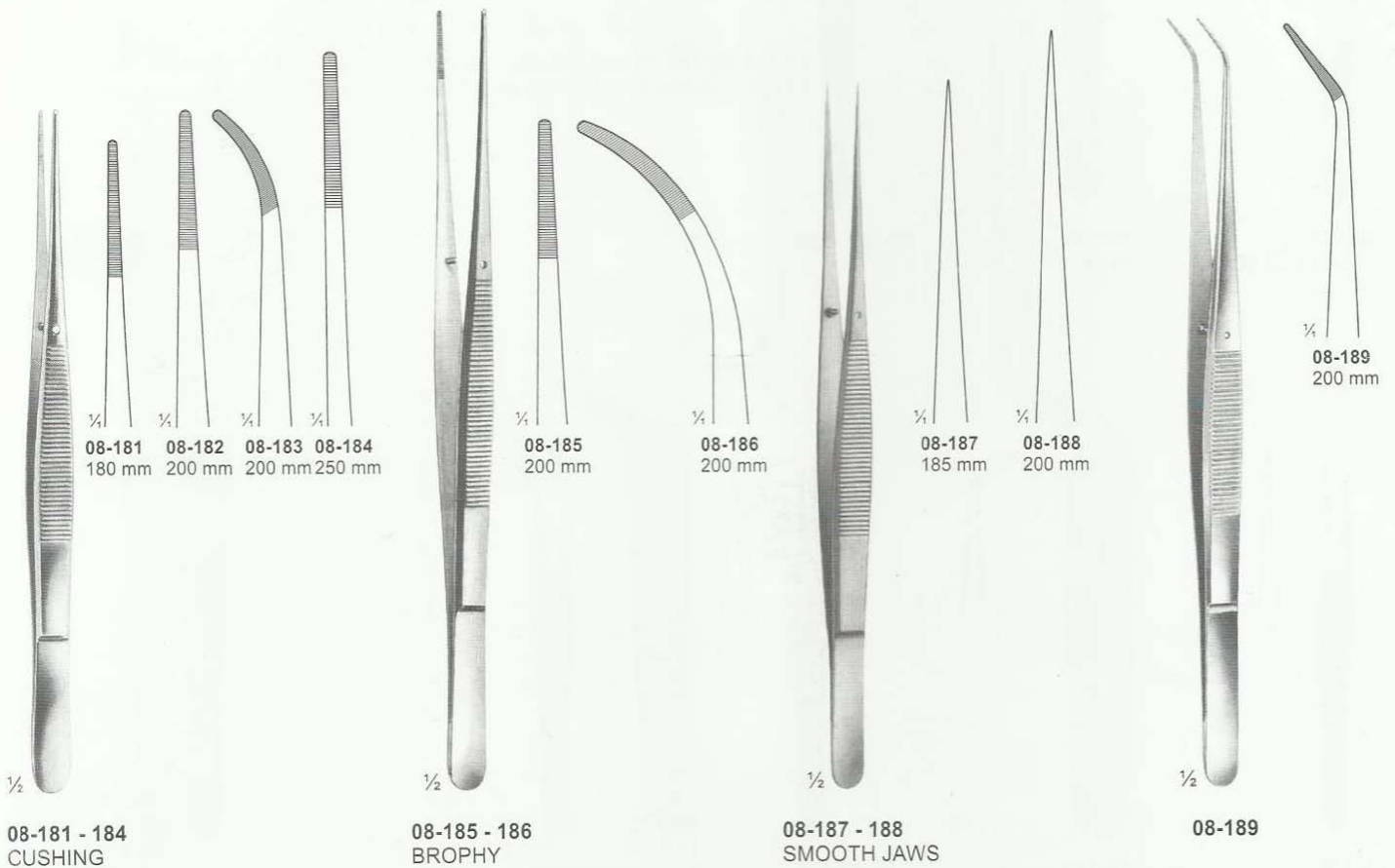
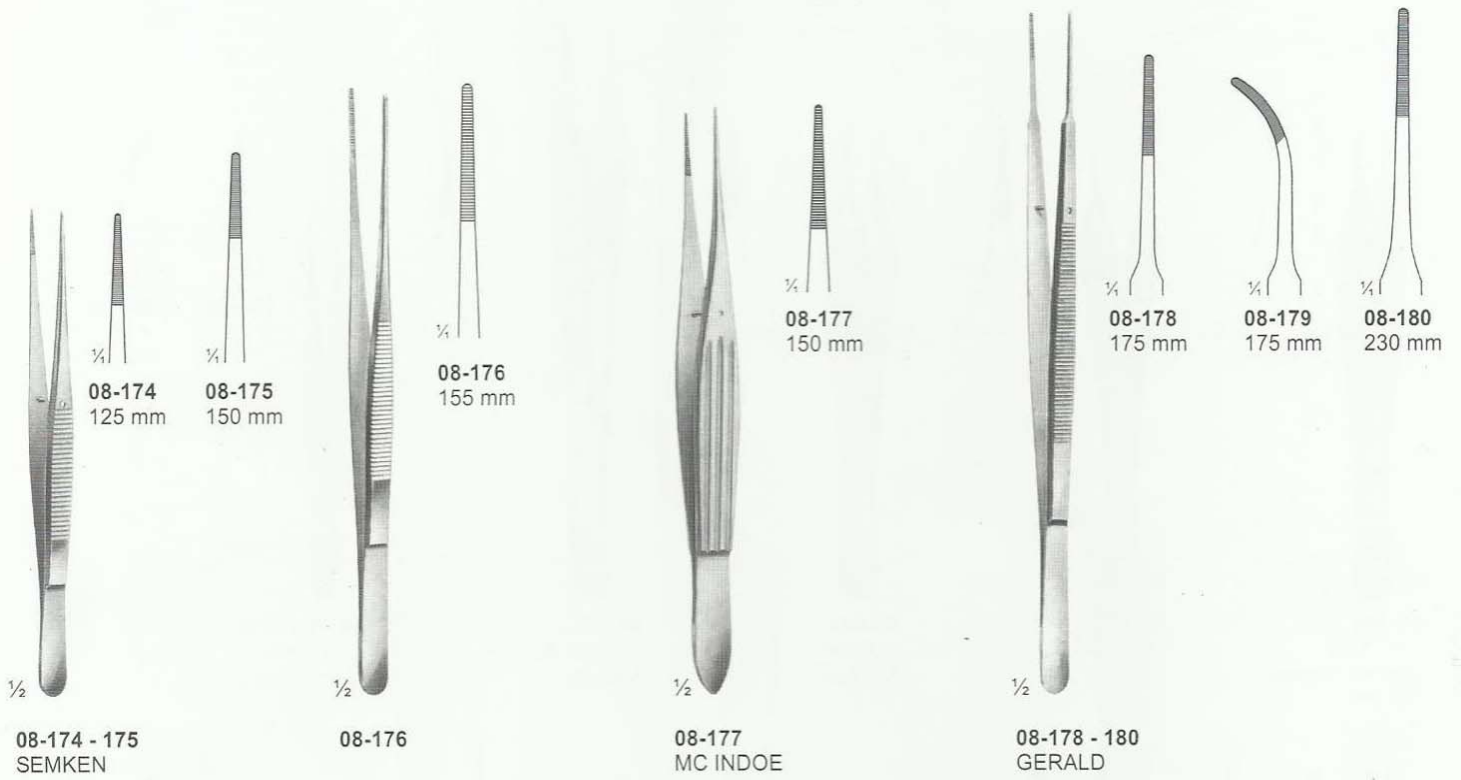



08-190 - 197
STANDARD

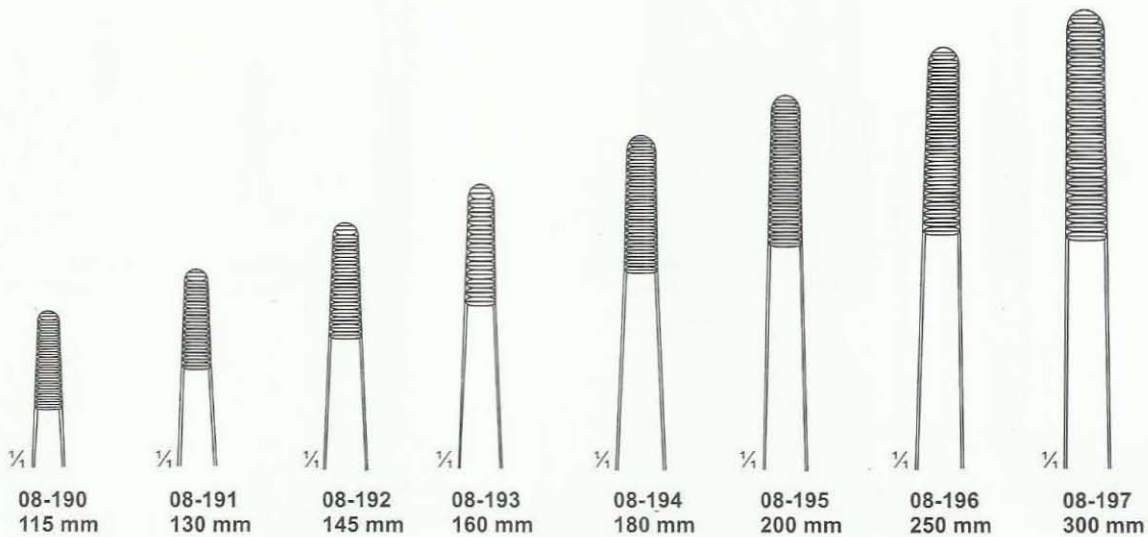

1/2

08-190 115 mm
08-191 130 mm
08-192 145 mm
08-193 160 mm
08-194 180 mm
08-195 200 mm
08-196 250 mm
08-197 300 mm



08-198 - 202
MEDIUM

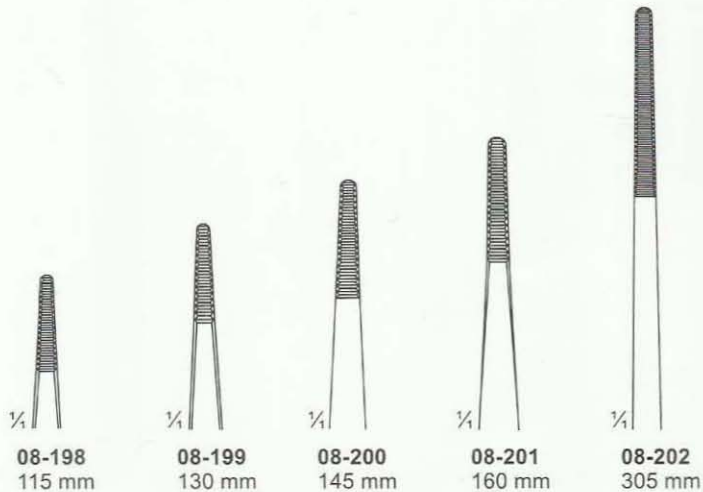

08-198 115 mm
08-199 130 mm
08-200 145 mm
08-201 160 mm
08-202 305 mm

1/2



08-203 - 204
MEDIUM

08-203 130 mm
08-204 145 mm



08-205 - 206



08-205
125 mm



08-206
155 mm



08-207 - 210
Swedish pattern



08-207
130 mm



08-208
150 mm



08-209
170 mm



08-210
200 mm



08-211
OCHSNER
Ligature forceps
145mm



08-212
FRICKE
Artery forceps
130mm



08-213
BONNEY
175mm





08-214
150 mm



08-215
200 mm



08-216
240 mm



08-217
300 mm



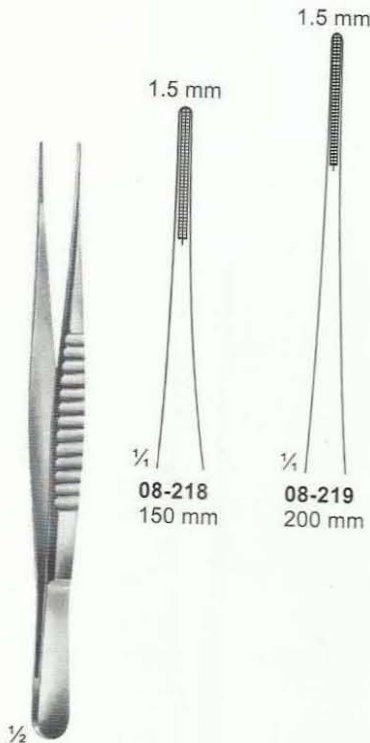

08-218
150 mm

08-219
200 mm

08-218 - 219
DE BAKEY

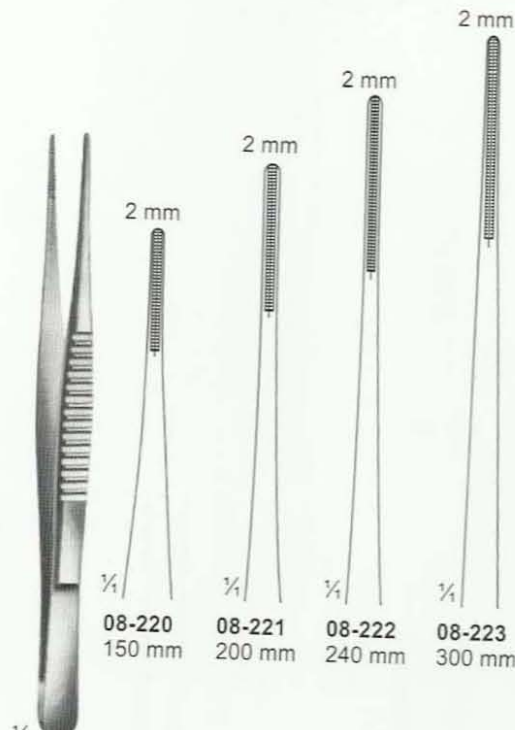

08-220
150 mm

08-221
200 mm

08-222
240 mm

08-223
300 mm

08-220 - 223
DE BAKEY

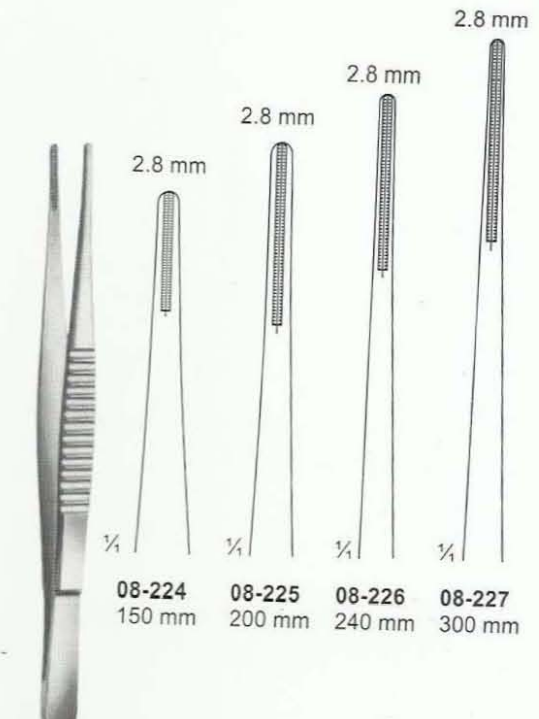

08-224
150 mm

08-225
200 mm

08-226
240 mm

08-227
300 mm

08-224 - 227
DE BAKEY

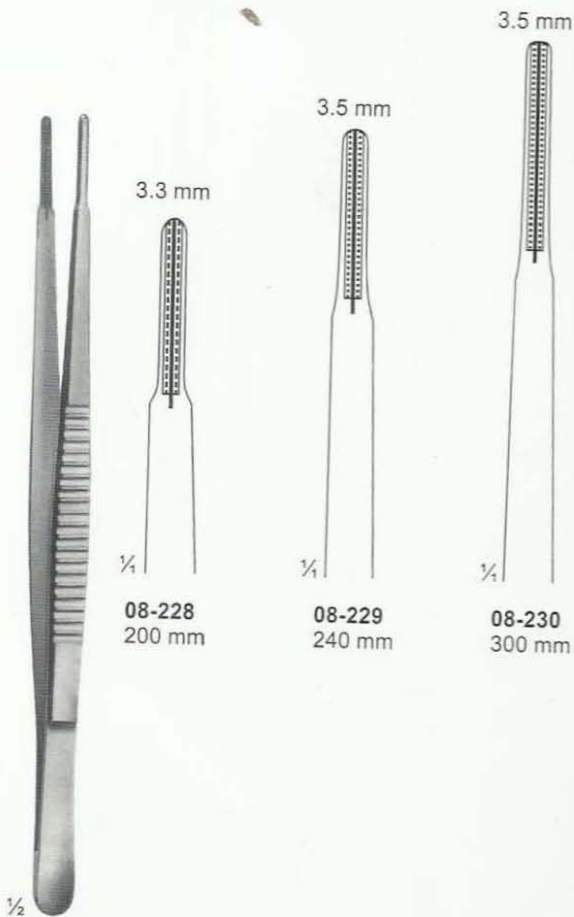

08-228
200 mm

08-229
240 mm

08-230
300 mm

08-228 - 230
DE BAKEY

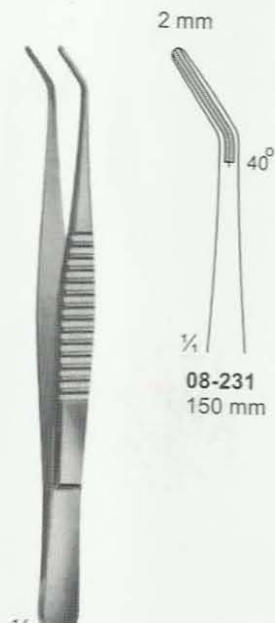

08-231
150 mm

08-232
200 mm

08-231
DE BAKEY

08-232
DE BAKEY

Forceps, Bayonet - Shaped, Angular



08-233
LUCAE
140 mm



08-234
LUCAE
1x2 teeth
140 mm

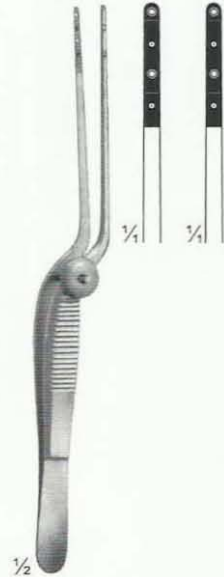

08-235
COTTLE
Forceps with
jaws toothed
and serrated
140 mm



08-236
JANSEN
160 mm

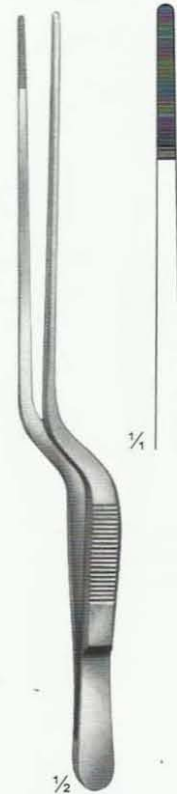

08-237
GRUENWALD
200 mm

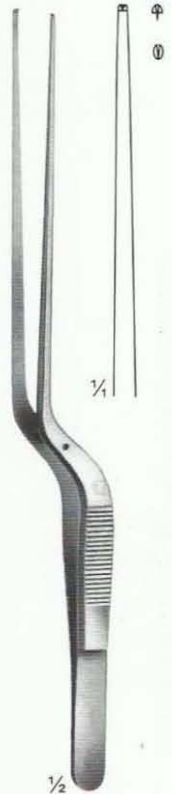

08-238
1x2 teeth
200 mm

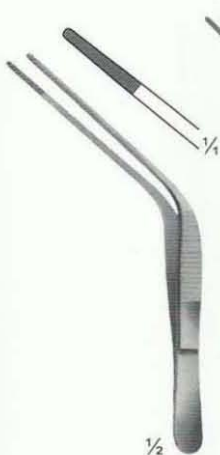

08-239
TROELTSCH
100 mm

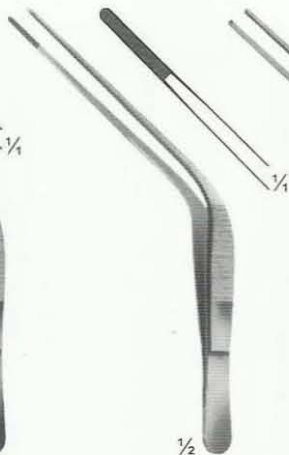

08-240
TROELTSCH
115 mm

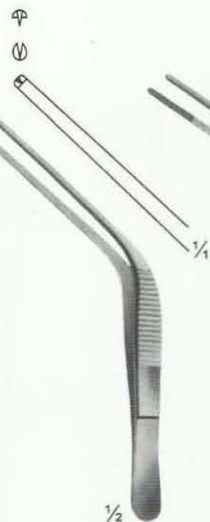

08-241
TROELTSCH
1X2 teeth
115 mm

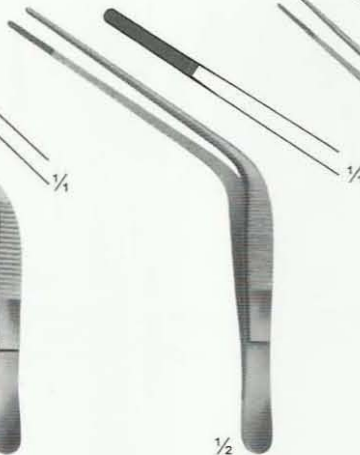

08-242
WILDE
115 mm

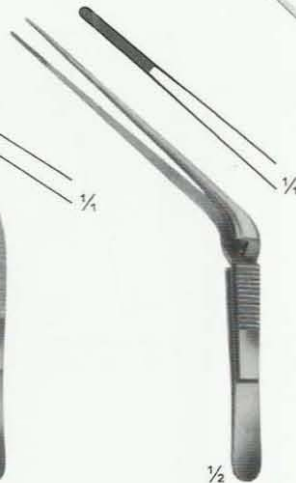

08-243
TROELTSCH
Cross action
120 mm



08-244
TROELTSCH
140 mm

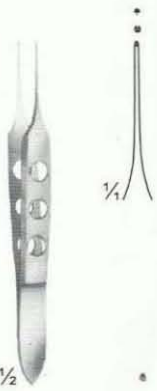

08-245
BISHOP-HARMON
85 mm

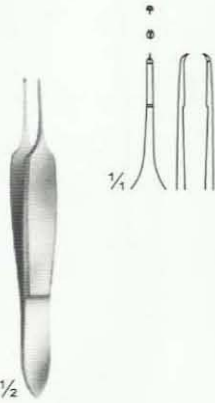

08-246
ST. MARTIN
80 mm

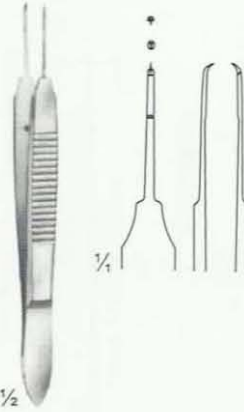

08-247
CASTROVIEJO
teeth 0.9 mm
100 mm

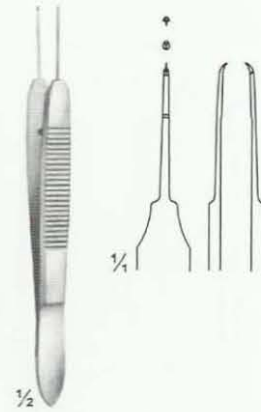

08-248
CASTROVIEJO
teeth 0.5 mm
100 mm

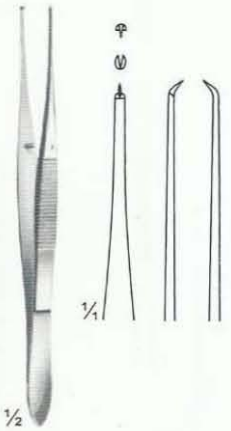

08-249
ELSCHING
110 mm



08-250
GILL
75 mm

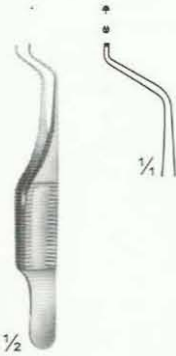

08-251
GILL - HESS
75 mm

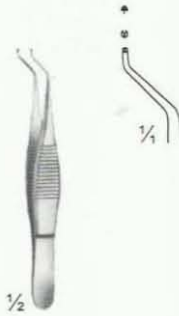

08-252
HESS
70 mm

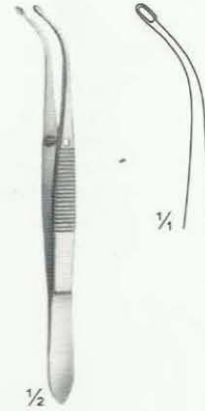

08-253
ARRUGA
100 mm

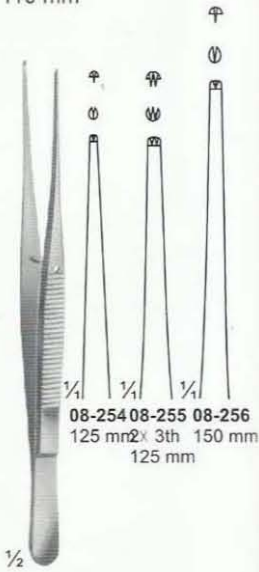

08-254-256
SEMKEN
125 mm 150 mm 125 mm

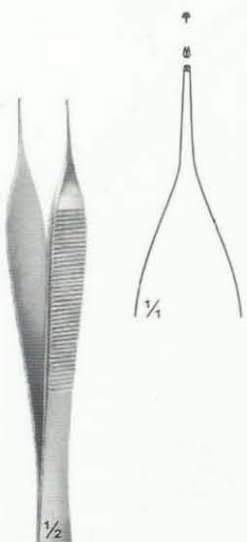

08-257
MICRO-ADSON
120 mm

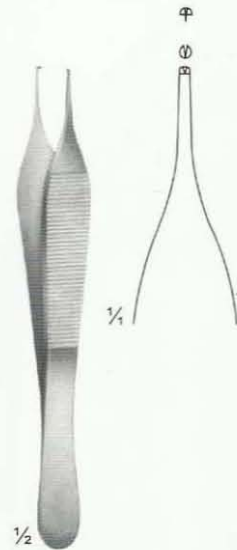

08-258
ADSON
120 mm

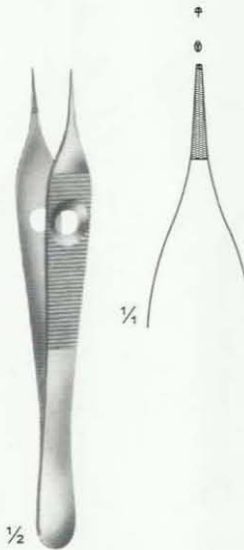

08-259
ADSON
120 mm

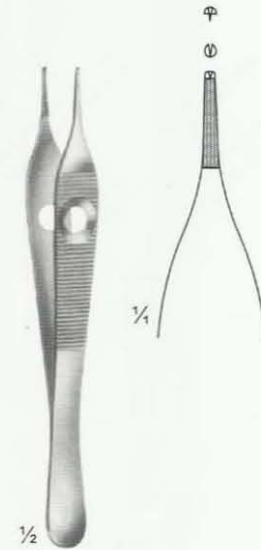

08-260
ADSON
120 mm

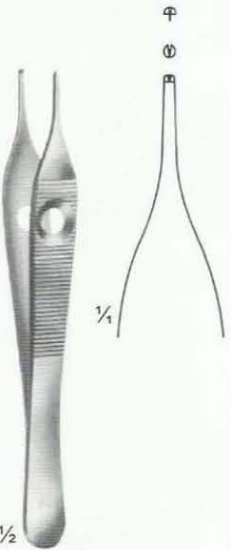

08-261
ADSON
120 mm

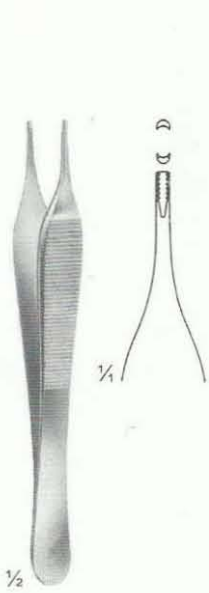

08-262
ADSON - BROWN
Non-traumatic
120 mm

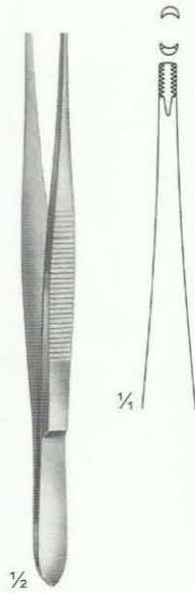

08-263
BROWN
150 mm

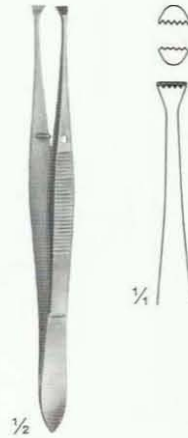

08-264
GRAEFE
110 mm

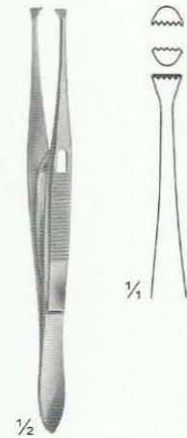

08-265
GRAEFE
With Catch
110 mm

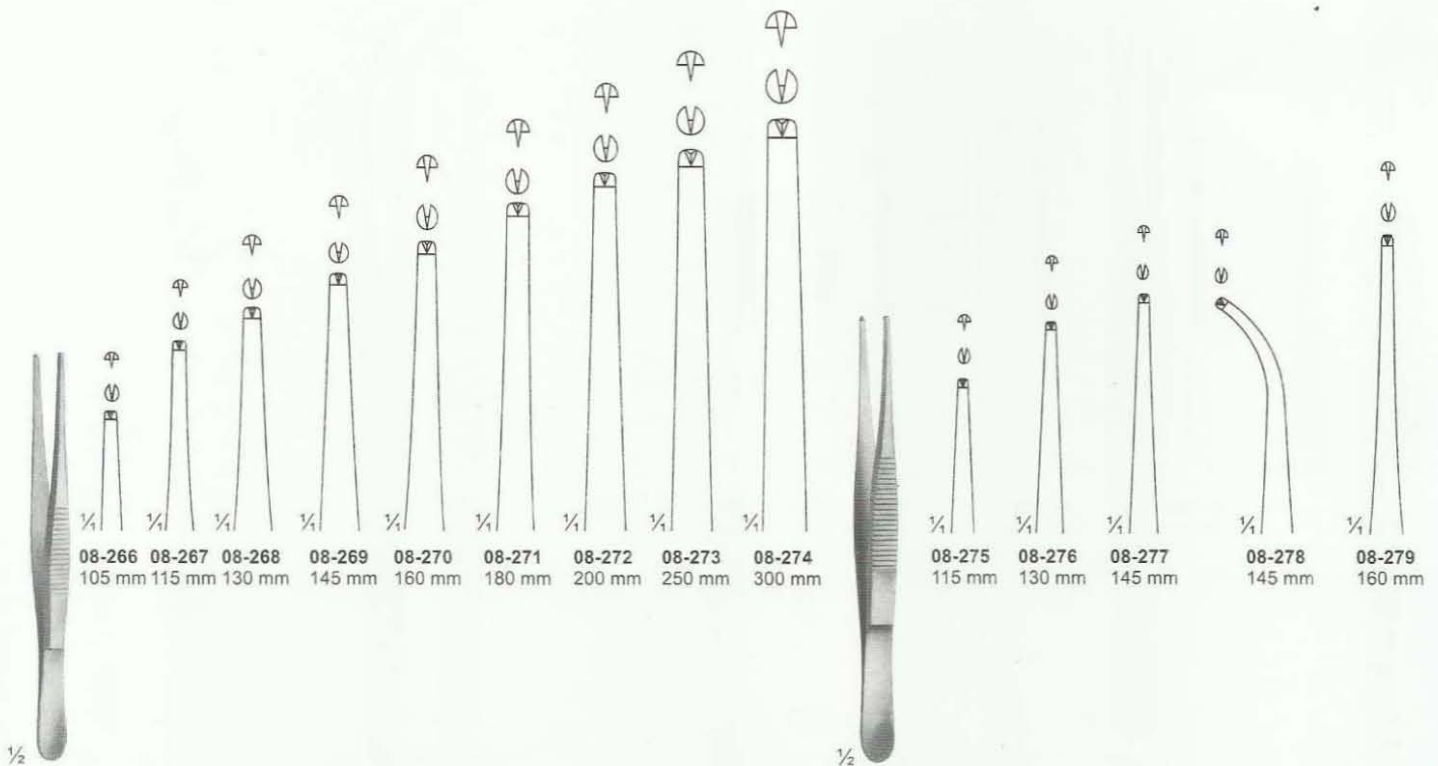

08-266 105 mm **08-267** 115 mm **08-268** 130 mm **08-269** 145 mm **08-270** 160 mm **08-271** 180 mm **08-272** 200 mm **08-273** 250 mm **08-274** 300 mm

08-275 115 mm **08-276** 130 mm **08-277** 145 mm **08-278** 145 mm **08-279** 160 mm

08-266 - 274
STANDARD

08-275 - 279
Medium

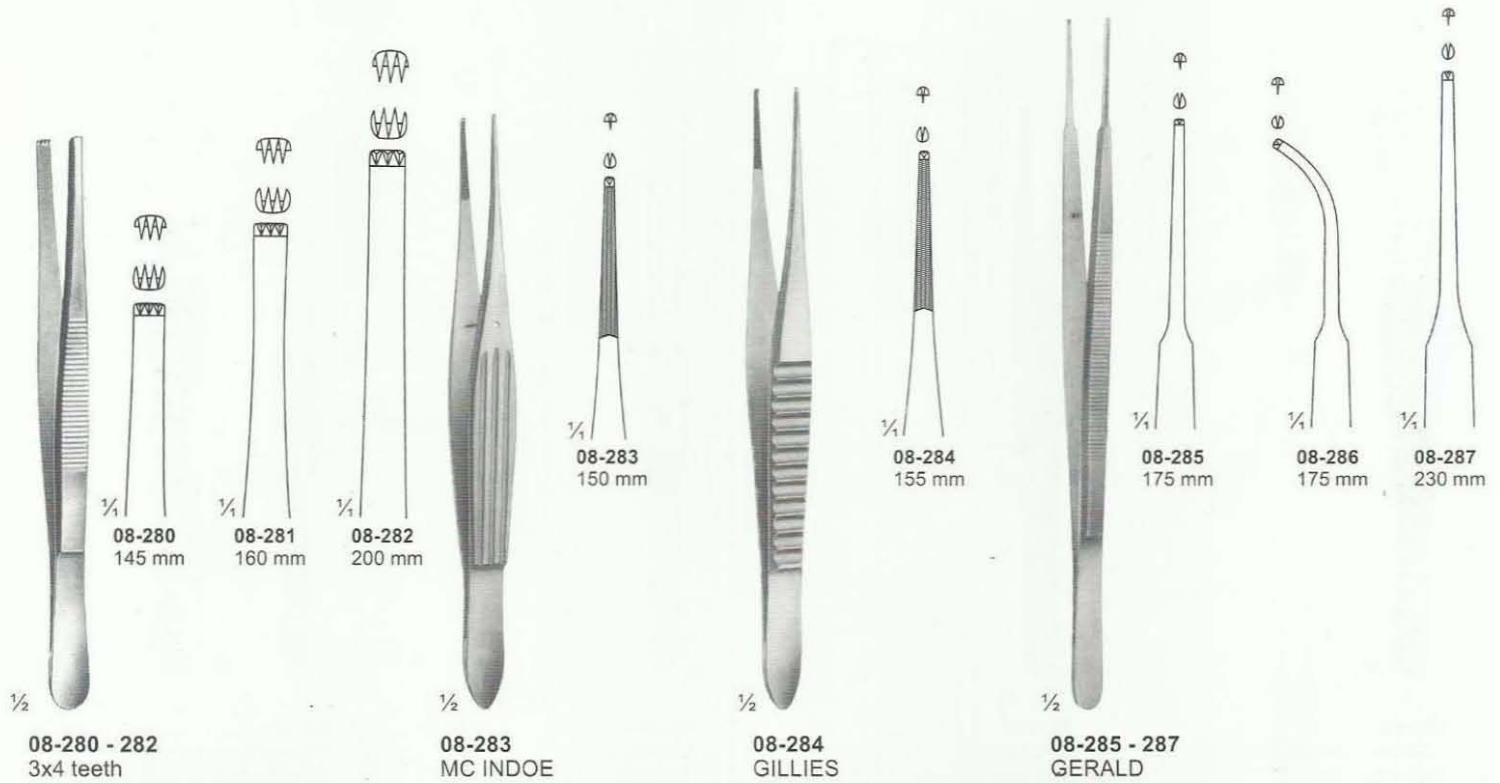

Tissue Forceps, Lung Dissecting Forceps, Intestinal Forceps



08-293 - 295
LANE



08-293
150 mm



08-294
2x3th.
150 mm



08-295
175 mm



08-296 - 297
STRASSBURGER
MODELL

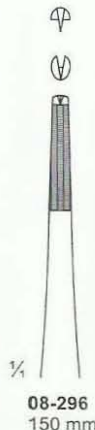

08-296
150 mm



08-297
200 mm



08-298
BONNEY

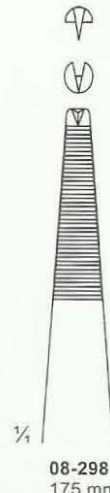

08-298
175 mm



08-299
RUSS. MODEL
200 mm



08-299
200 mm



08-300
TUTTLE
Lung Dissecting Forceps
230 mm

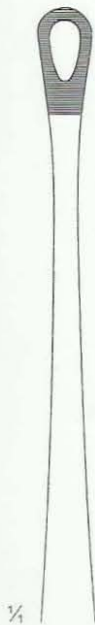

1/4



08-301
NELSON
Lung Dissecting Forceps
230 mm



1/4



08-302
DUVAL
Intestinal Forceps
140 mm



1/4



08-303
DENIS-BROWNE
Intestinal Forceps
190 mm



1/4

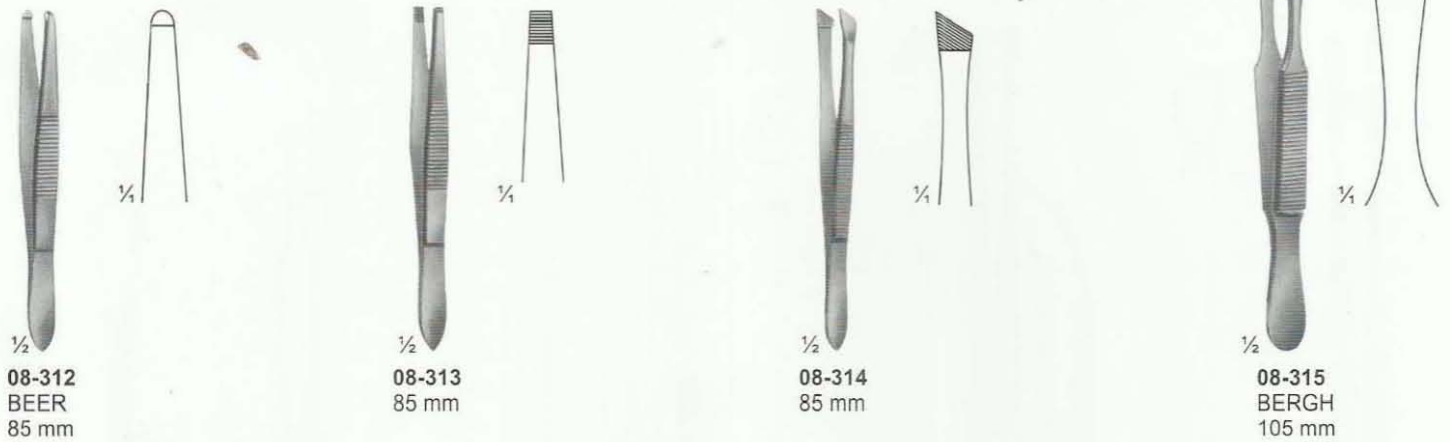
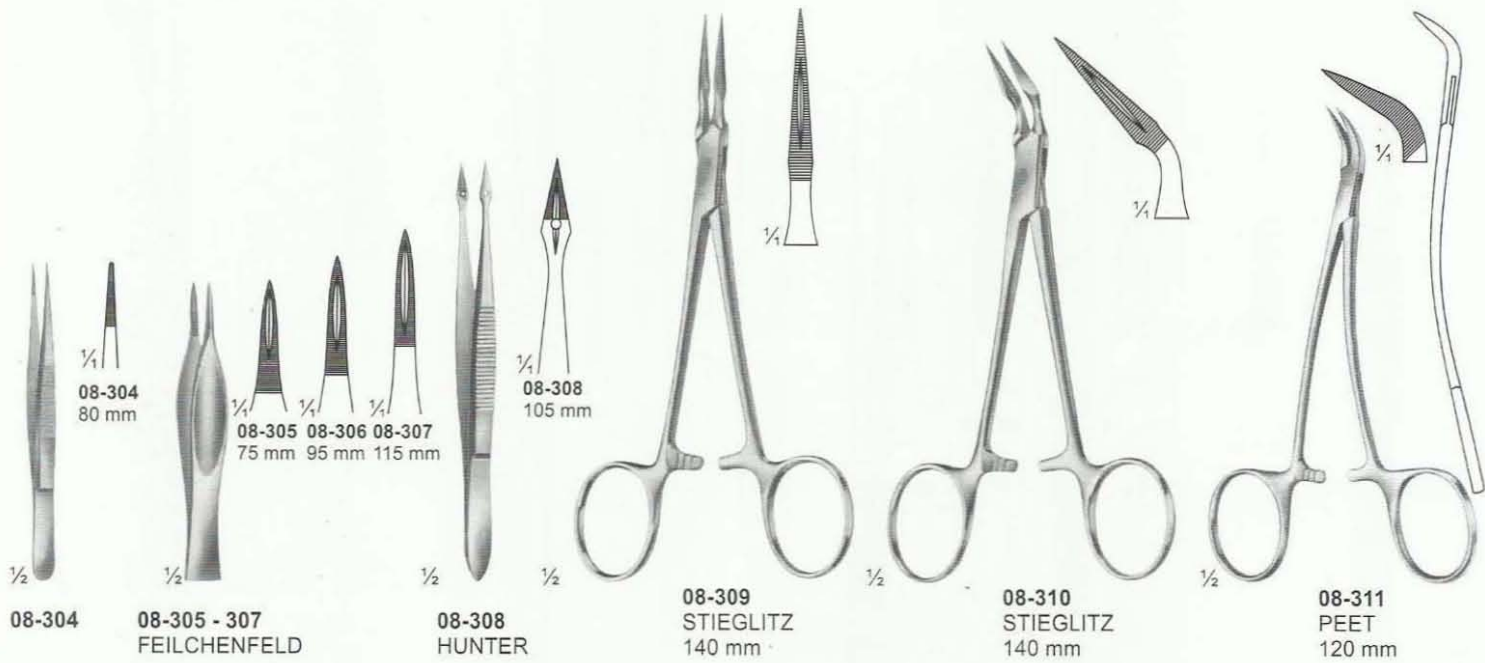

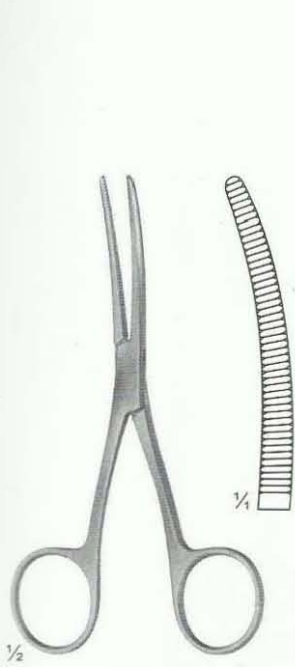

08-320
BRYANT
130 mm

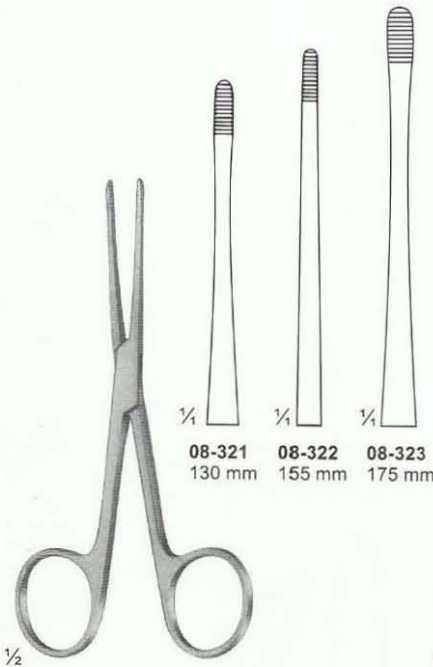

08-321 - 323
LISTER
Sinus Forceps

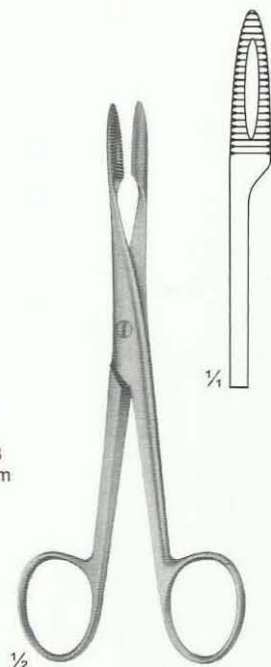

08-324
Without Ratchet
145 mm

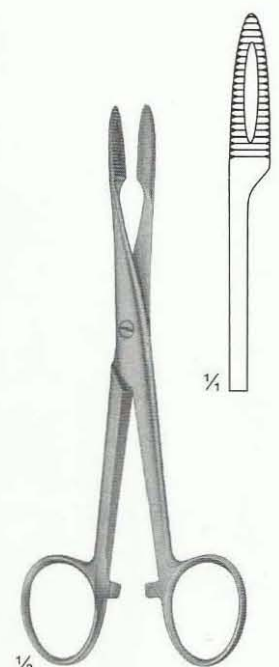

08-325
With Ratchet
145 mm

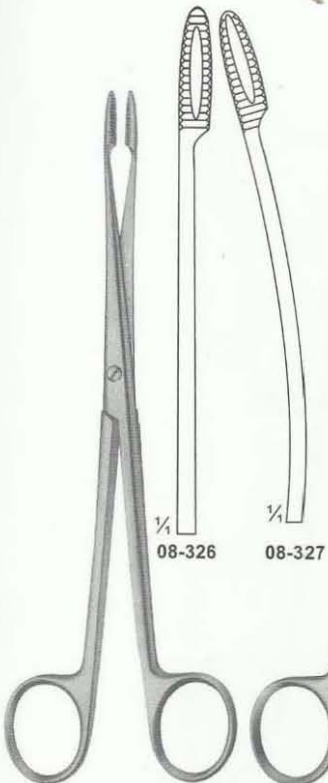

08-326 - 327
GROSS
Without Ratchet
180 mm

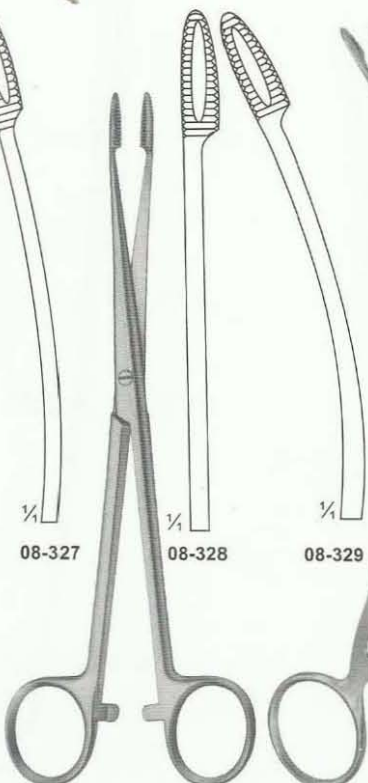

08-328 - 329
GROSS
With Ratchet
180 mm

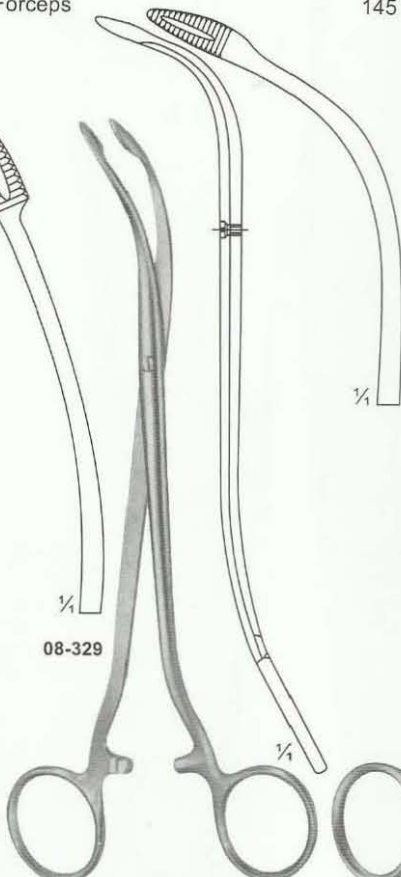

08-330
DUPLAY
190 mm

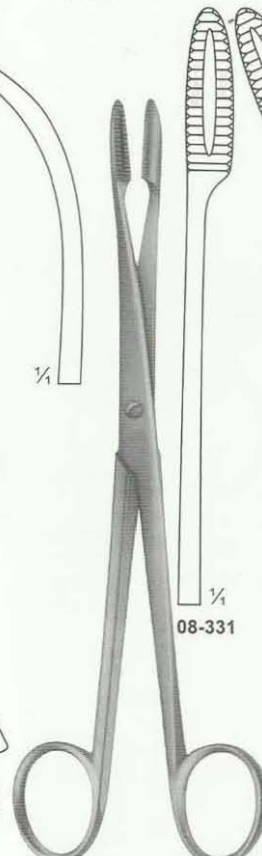

08-331 - 332
GROSS
Without Ratchet
200 mm

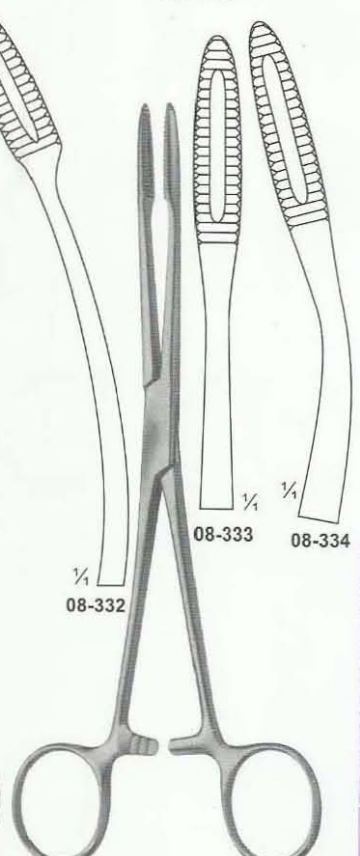

08-333 - 334
GROSS
With Ratchet
200 mm

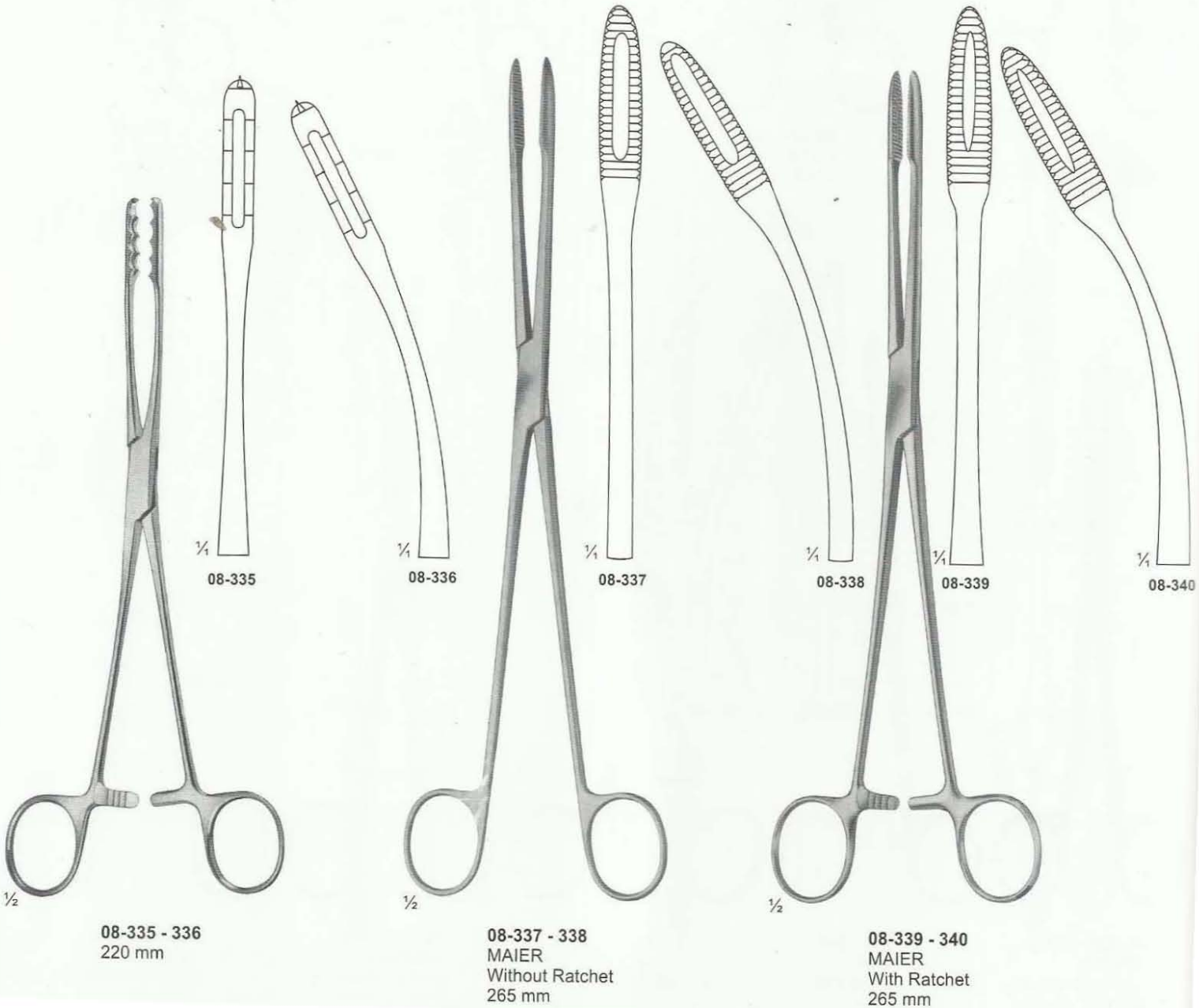



1/4
08-341

1/4
08-342

1/4

1/4

1/4

1/2

1/2

1/2

1/2

08-341 - 342
SIMS-MAIER
280 mm

08-343
COLLIN
240 mm

08-344
CHERON
Handles Laterally Angled
240 mm

08-345
EMMET
210 mm

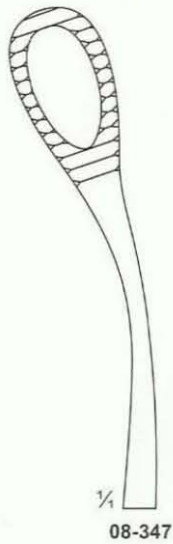
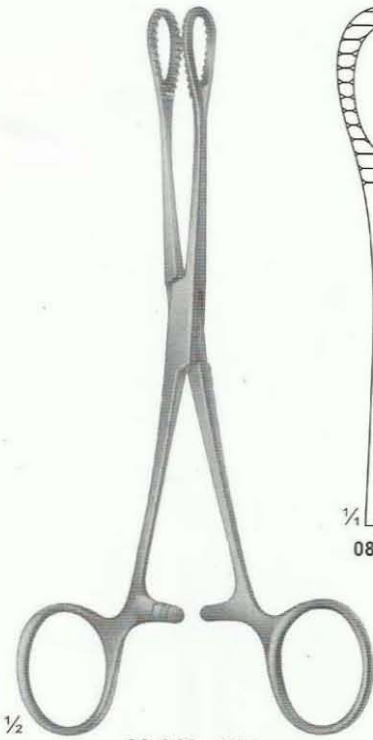

08-346 - 347
FOERSTER-BALLENGER
180 mm

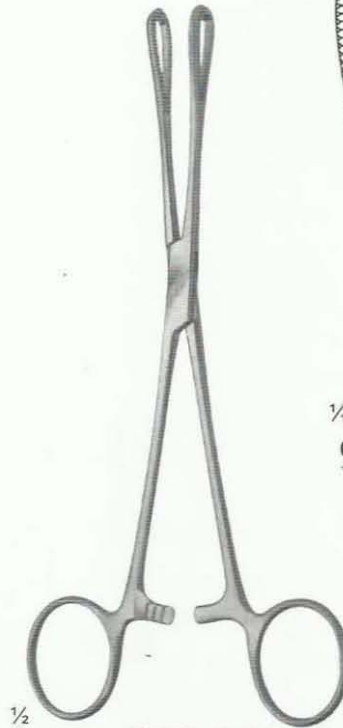

08-348 - 349
RAMPLEY

08-349
250 mm

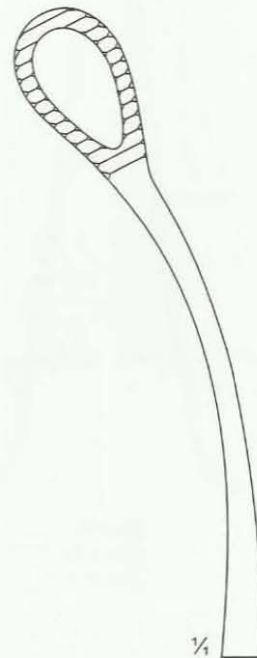
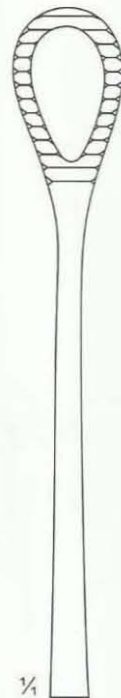
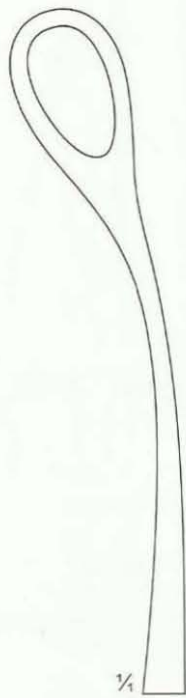
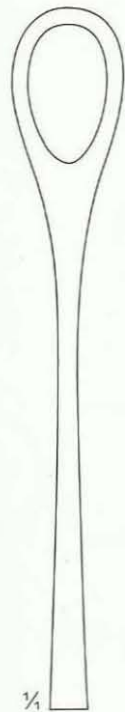

08-350
Smooth Jaws

08-351
Smooth Jaws

08-352
Serrated Jaws

08-353
Serrated Jaws

08-350 - 353
FOERSTER-BALLENGER
240 mm

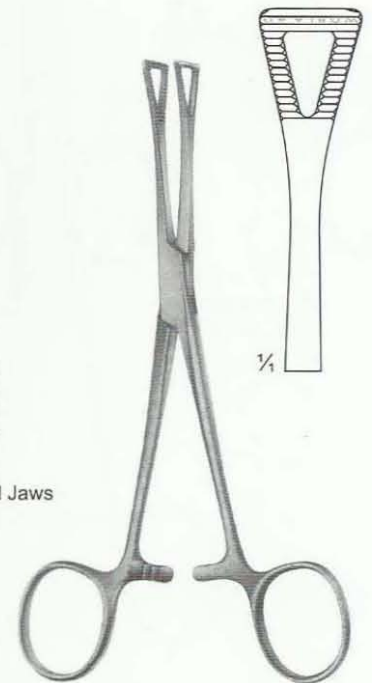

08-354
PENNINGTON
155 mm

ATRAUMATA

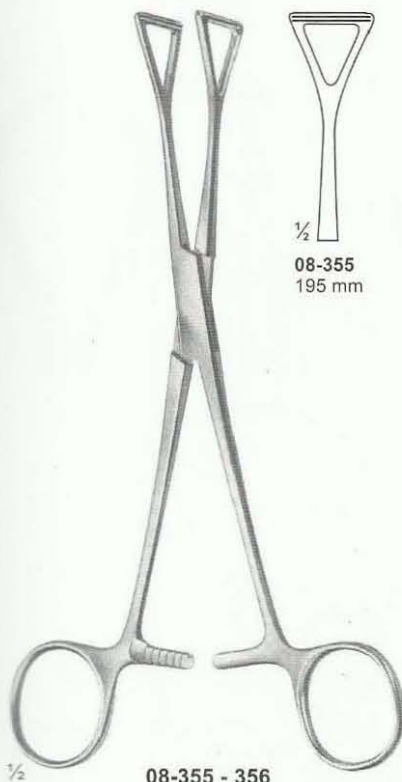

1/2
08-355 - 356
COLLIN



1/2
08-355
195 mm



1/2
08-356
230 mm

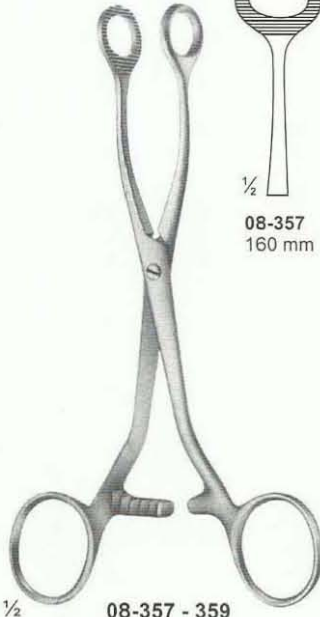

1/2
08-357 - 359
COLLIN



1/2
08-357
160 mm



1/2
08-358
160 mm

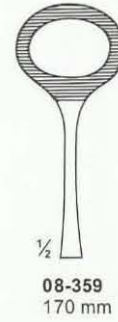

1/2
08-359
170 mm

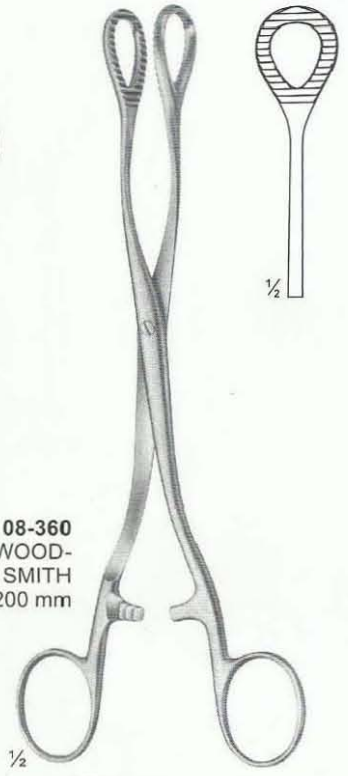

08-360
HEYWOOD-
SMITH
200 mm

1/2

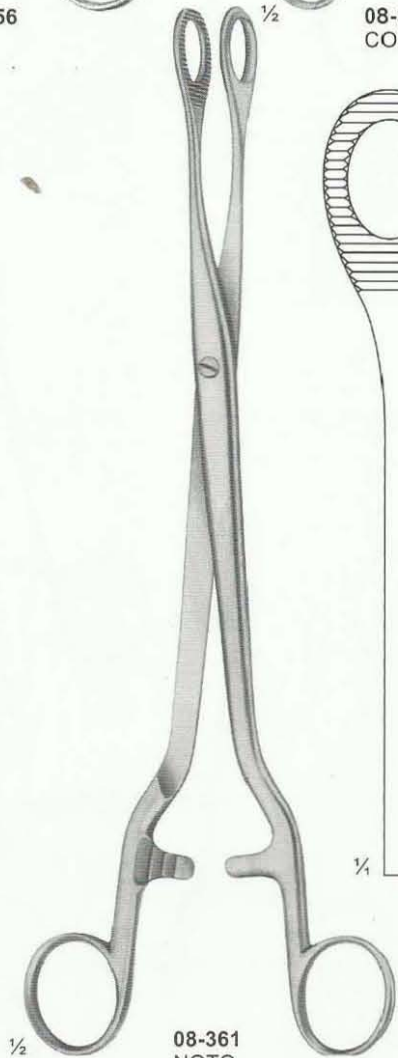

1/2
08-361
NOTO
280 mm

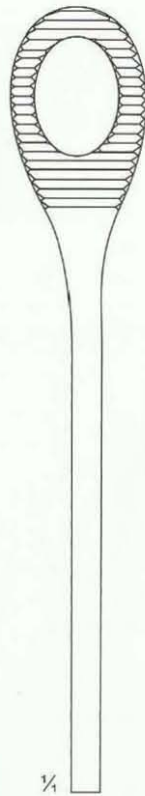

1/4

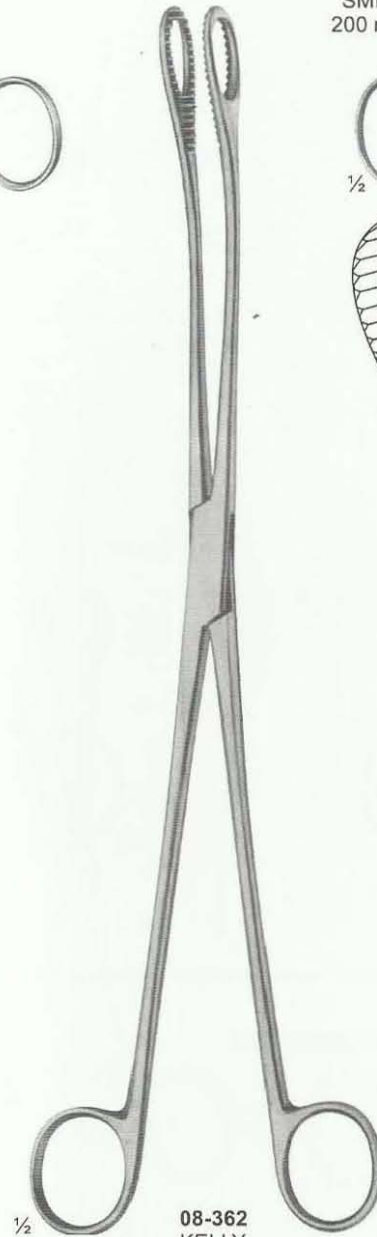

1/2
08-362
KELLY
320 mm



1/4

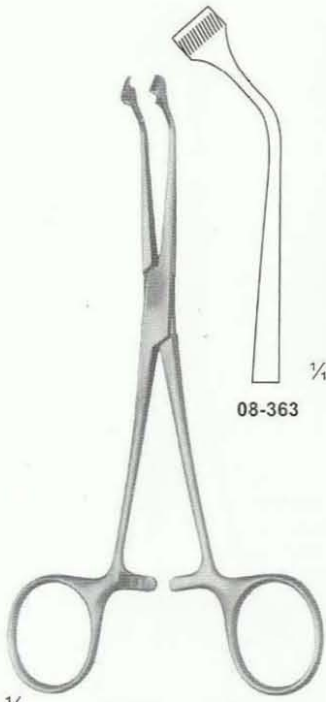

08-363

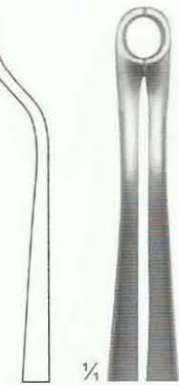

08-364

$\frac{1}{2}$
08-363 - 364
HERZ
155 mm



08-365



$\frac{1}{2}$
08-365
JACKSON
4 x 5 teeth
150 mm

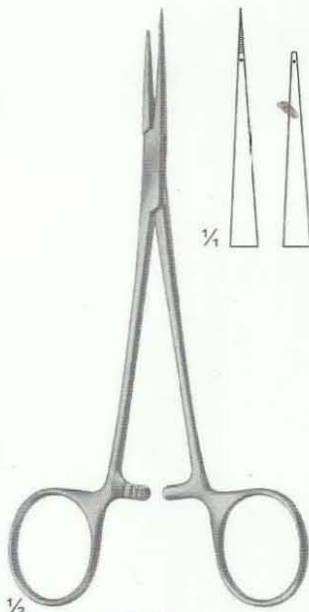

$\frac{1}{2}$
08-366
Tendon interlacing
forceps
150 mm

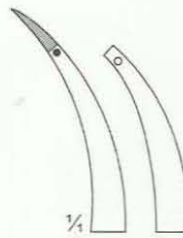
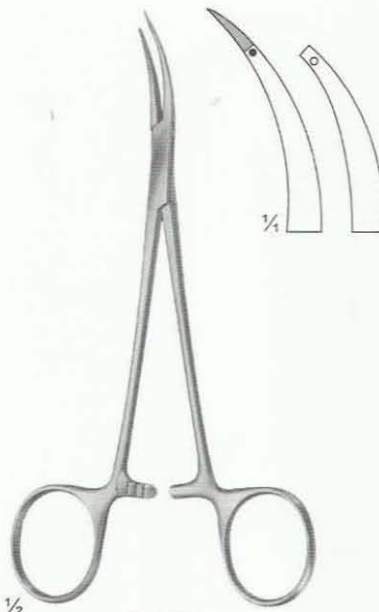

$\frac{1}{2}$
08-367
Tendon interlacing
forceps
150 mm

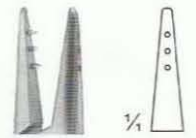
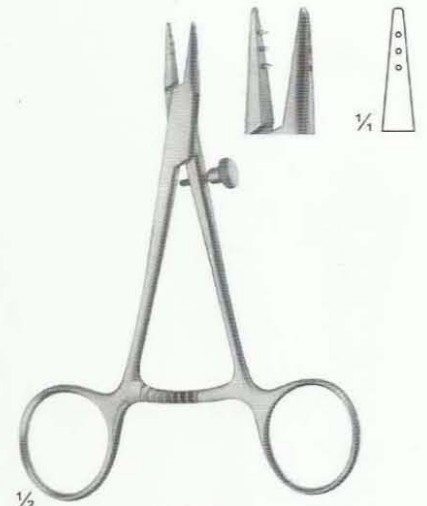

$\frac{1}{2}$
08-368
Tendon seizing
forceps
120 mm



08-369
JAGER
Tendon-and cross ligament
passing forceps
flexible shaft
275 mm

$\frac{1}{2}$

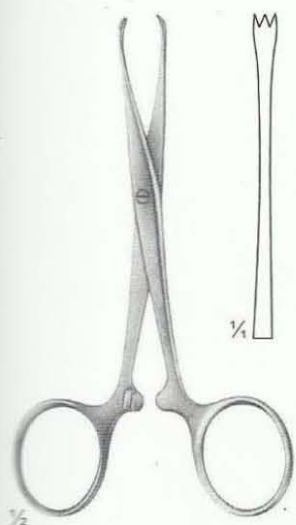

08-370
CHAPUT
 2 x 3 teeth sharp
 125 mm

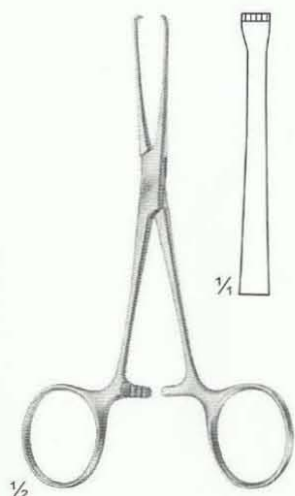

08-371
BABY-ALLIS
 4 x 5 teeth
 130 mm

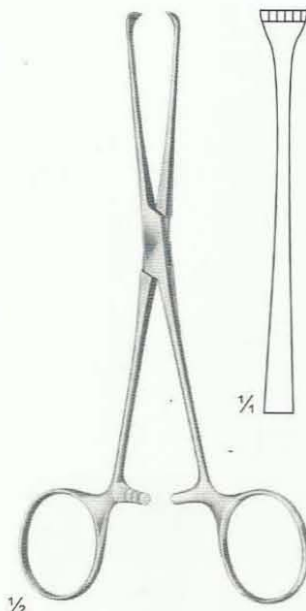

08-372
BOYS-ALLIS
 5 x 6 teeth sharp
 155 mm

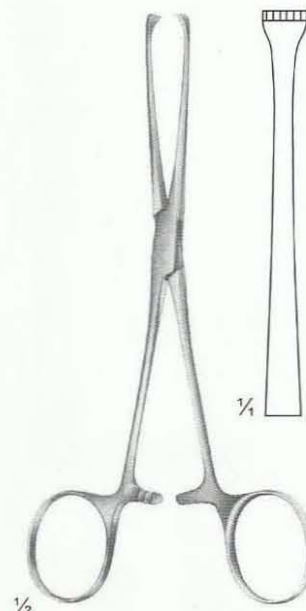

08-373
ALLIS
 5 x 6 teeth blunt
 155 mm

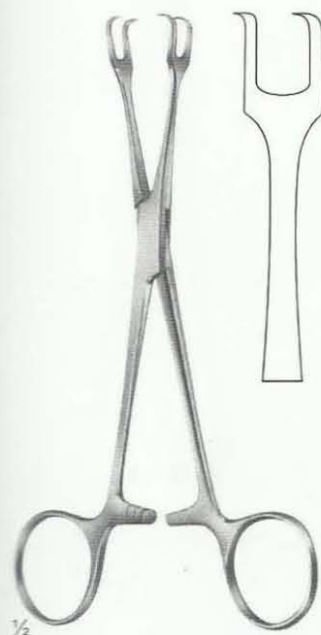

08-374
LAHEY
 155 mm

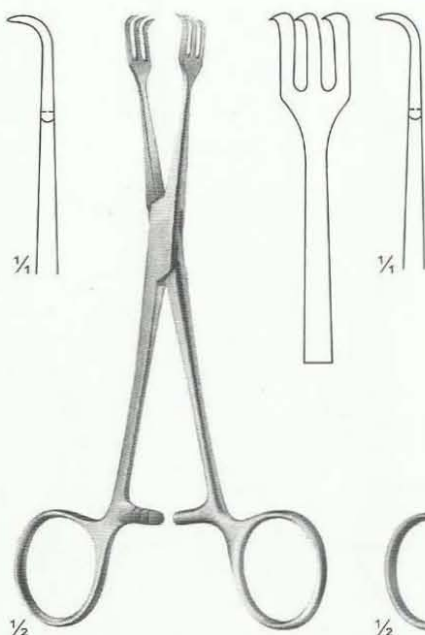

08-375
LAHEY
 155 mm

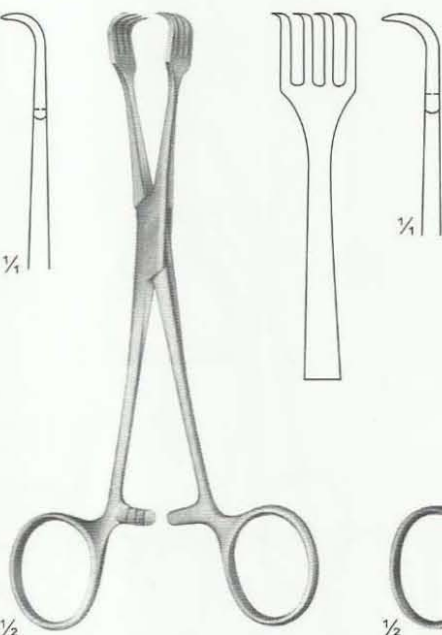

08-376
BRAUN
 155 mm

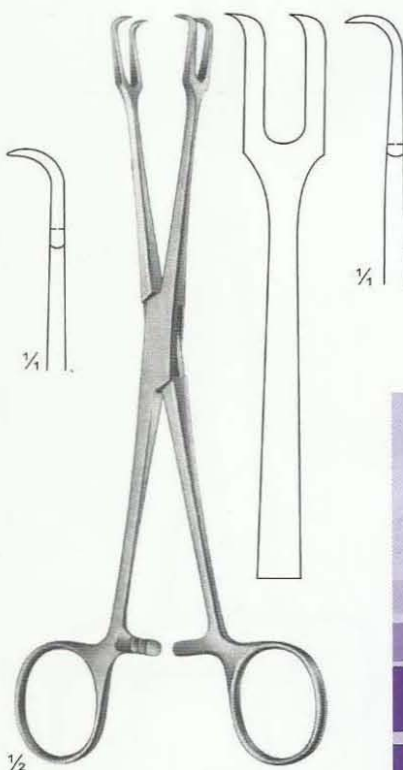

08-377
MUSEUX
 200 mm

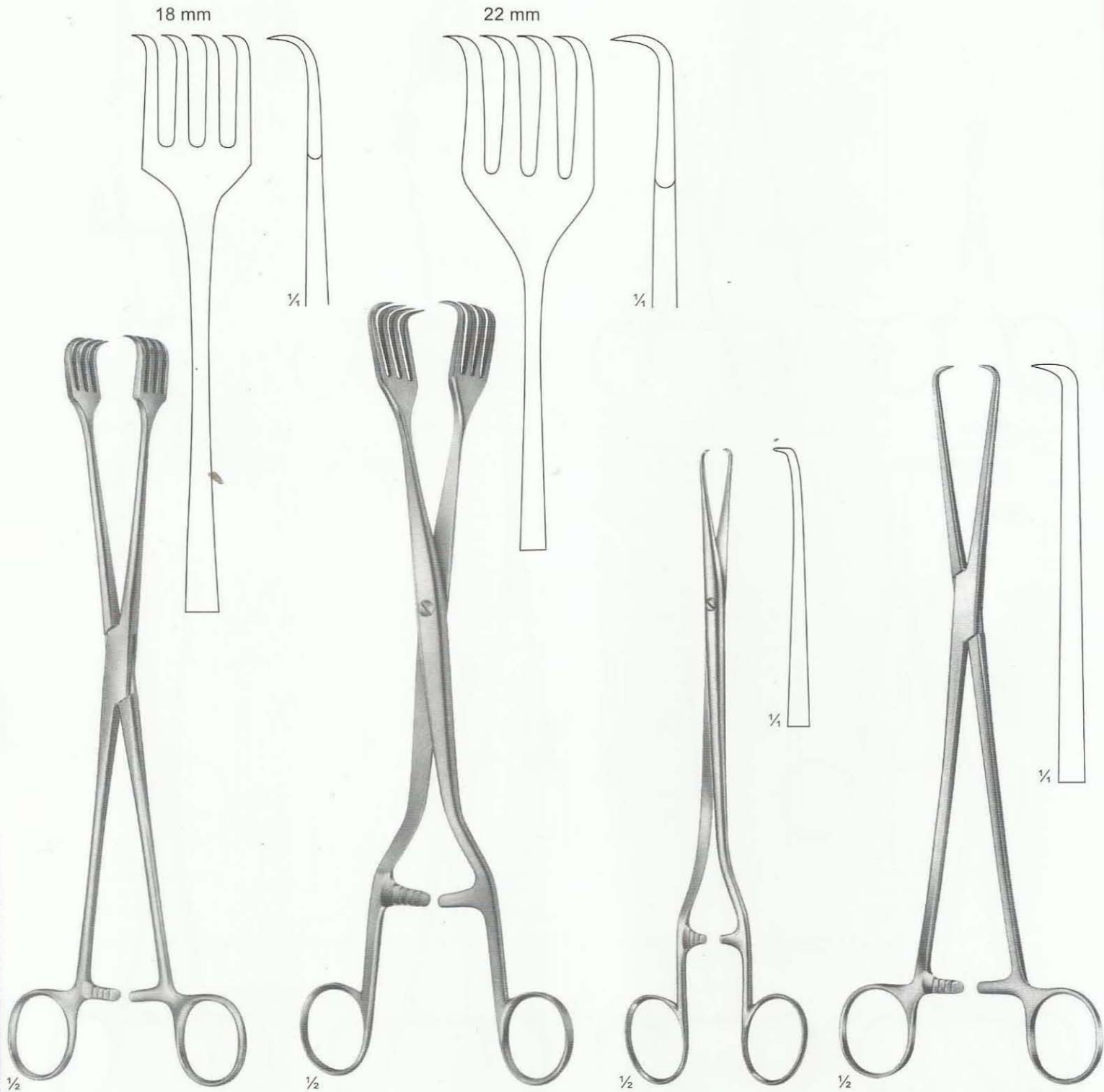

08-378
260 mm

08-379
PRATT
270 mm

08-380
TIEMANN
Bullet forceps
220 mm

08-381
SCHROEDER
250 mm



09-101
JONES
85 mm



09-102
ENGL.MOD.
85 mm

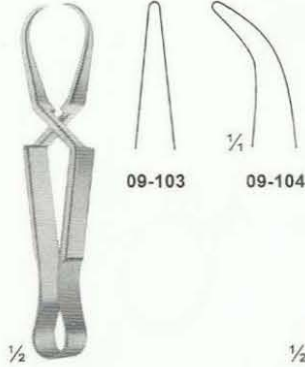

09-103 - 104
SCHAEDEL
85 mm

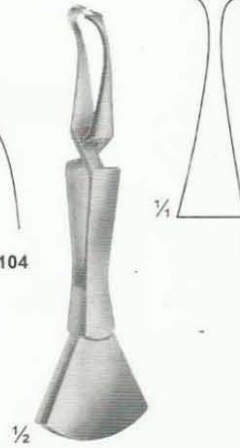

09-105
DOYEN
110 mm

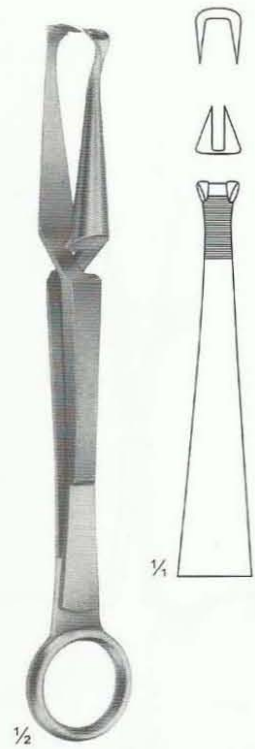

09-106
DOYEN
180 mm

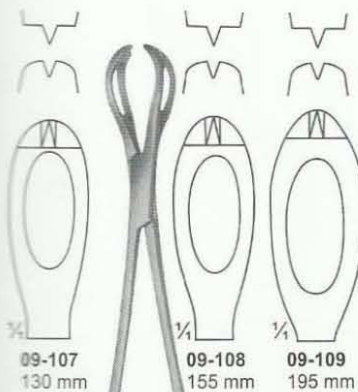

09-107
130 mm

09-108
155 mm

09-109
195 mm

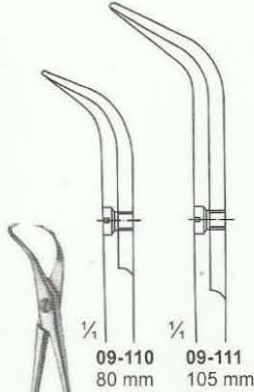

09-110
80 mm

09-111
105 mm

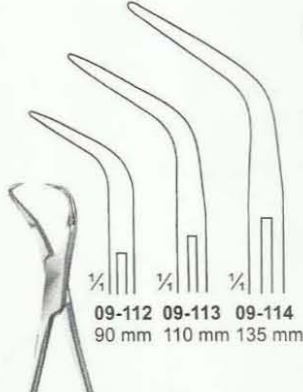

09-112 09-113 09-114
90 mm 110 mm 135 mm

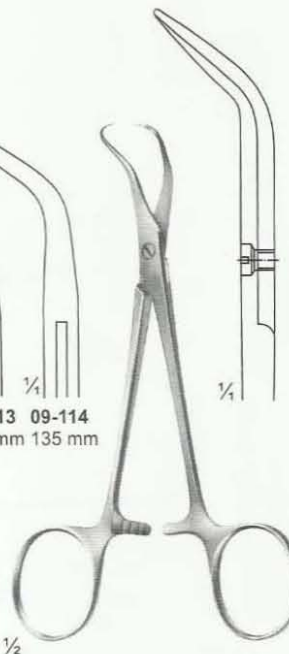

09-115
BACKHAUS-KOCHER
135 mm

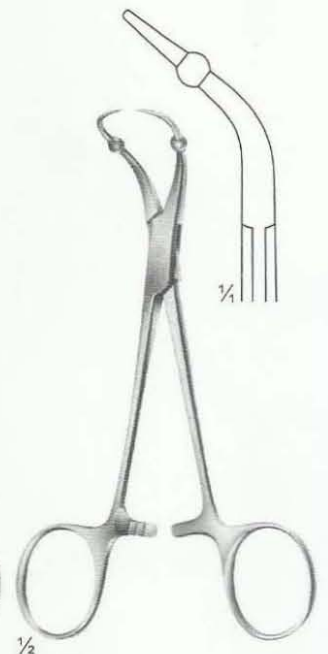

09-116
ROEDER
135 mm

09-107 - 109
LANE

09-110 - 111
BACKHAUS

09-112 - 114
BACKHAUS

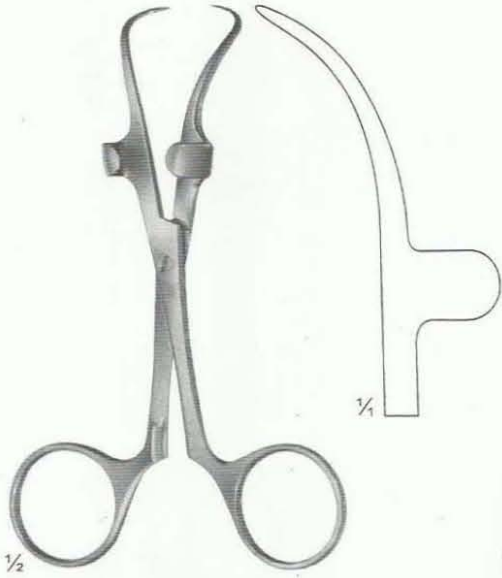

1/2
09-117
ROBIN
 with holders for tubing
 up to 13 mm
 135 mm

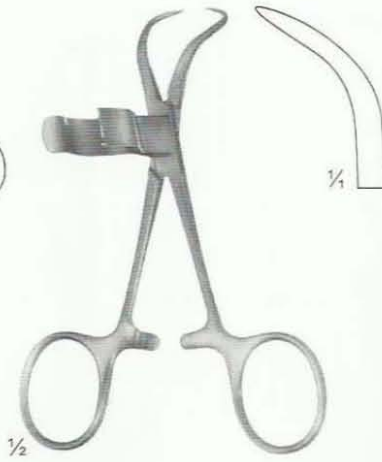

1/2
09-118
 with clip for tubing
 up to 15 mm
 110 mm

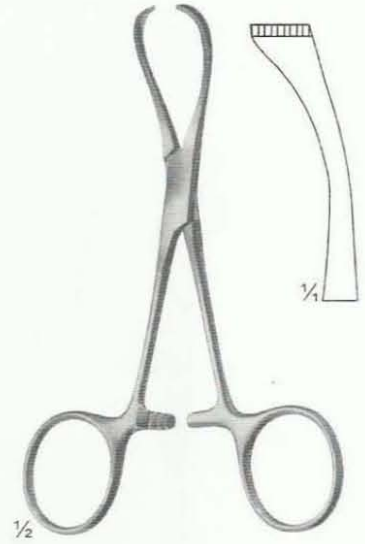

1/2
09-119
LORNA
 non perforating
 130 mm

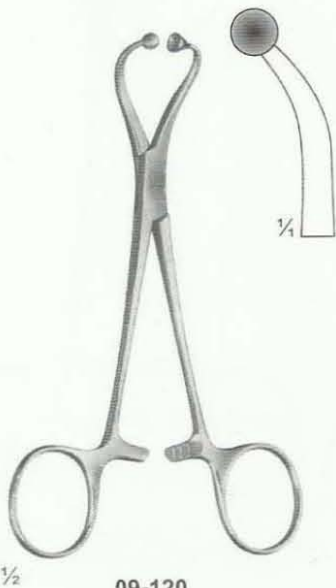

1/2
09-120
 for paper cloths

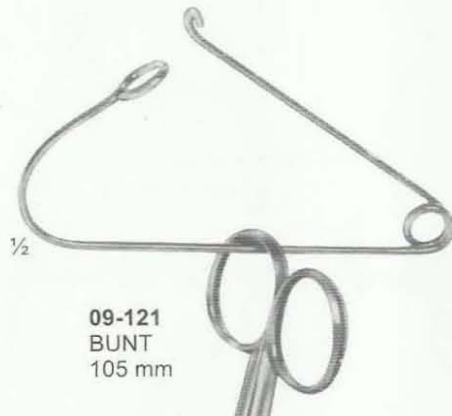

1/2
09-121
BUNT
 105 mm



1/2
09-122
MAYO
 140 mm

Closing force



09-123
Straight
50g



09-124
80g



09-125
Curved
50g



09-126
80g



09-127
Curved tips
50g



09-128
80g



09-129
Angled
Shaped
50g



09-130
80g



09-131
Muller
Knee-bent
50g

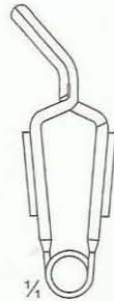

09-132
80g



09-133
Muller
Ligature Forceps



Jaw, cross
serrated
Jaws profiles
finally cross-
serrated.

● 09-123 - 09-132
Non-traumatic vessel clips, temporary.



09-134
38 mm
09-135
48 mm



09-136
38 mm
09-137
48 mm



09-138
58 mm



09-139
58 mm



09-140 - 146

- 09-140** 38 mm
- 09-141** 48 mm
- 09-142** 56 mm
- 09-143** 63 mm
- 09-144** 70 mm
- 09-145** 80 mm
- 09-146** 91 mm



09-147
DE BAKEY-
HESS
Length of
Jaws 20 mm

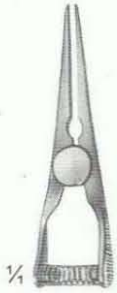

09-148
35 mm



09-149
35 mm

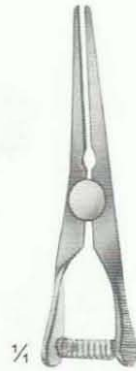

09-150
45 mm



09-151
45 mm



DE BAKEY

09-152
Length
50 mm
Jaws
27 mm



DE BAKEY

09-153
Length
48 mm
Jaws
27 mm



75°

09-154
GLOVER
Length
57 mm
Jaws 35 mm

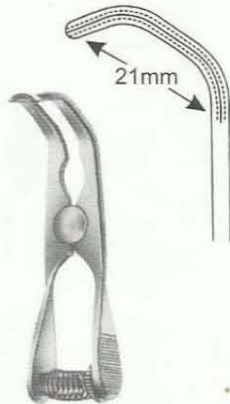

21mm

09-155
DE BAKEY
Length 73 mm
Jaws 38 mm

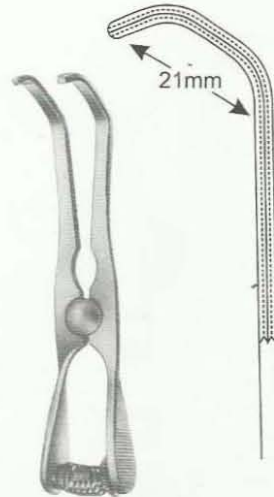

21mm

09-156
DE BAKEY
Length 99 mm
Jaws 63 mm

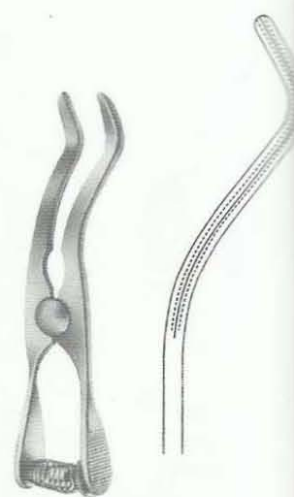

09-157
DE BAKEY
Length 95 mm
Jaws 54 mm



DE BAKEY

	Total length	Length of jaw
09-158	80mm	25mm
09-159	90mm	35mm
09-160	105mm	50mm



DE BAKEY

	Total length	Length of jaw
09-162	78mm	25mm
09-163	86mm	35mm
09-164	97mm	50mm



GLOVER

	Total length	Length of jaw
09-166	68mm	33mm
09-167	96mm	50mm
09-168	117mm	69mm



GLOVER

	Total length	Length of jaw
09-169	65mm	33mm
09-170	91mm	50mm
09-171	110mm	69mm



10-101
CARREL
85 mm



10-102 - 105
BABY-MOSQUITO
(HARTMANN)
100 mm

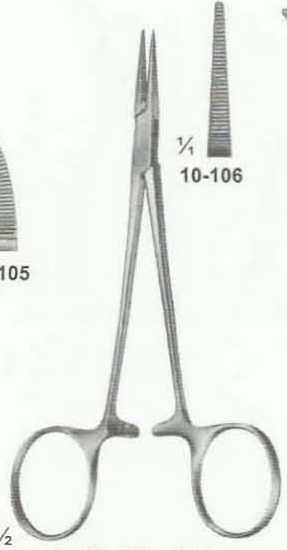

10-106 - 109
MICRO-HALSTED
125 mm



8.5 cm
14 cm
16.5 cm



8.5 cm
14 cm



8.5 cm



8.5 cm



8.5 cm



8.5 cm



8.5 cm



8.5 cm



10-110 - 113
HALSTED-MOSQUITO
125 mm

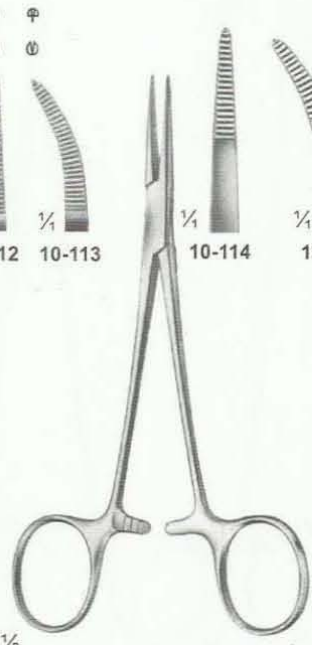

10-114 - 115
PROVIDENCE-HOSPITAL
140 mm

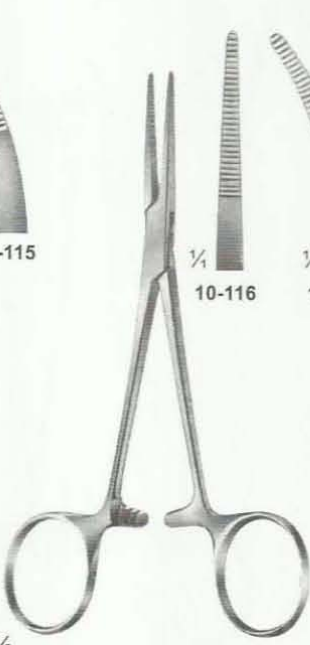

10-116 - 117
KELLY
140 mm

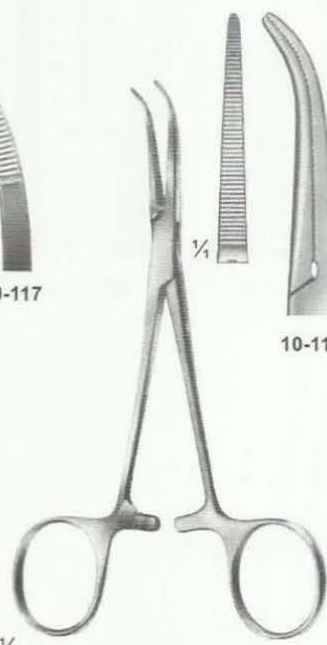

10-118 - 119
DANDY
Curved sideways
140 mm

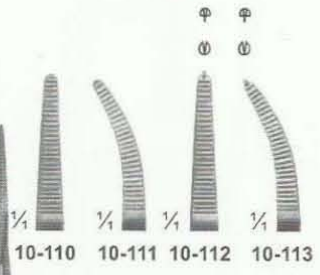

10-110 10-111 10-112 10-113

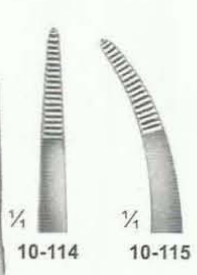

10-114 10-115



10-116 10-117

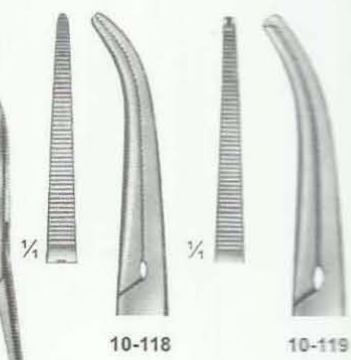

10-118 10-119

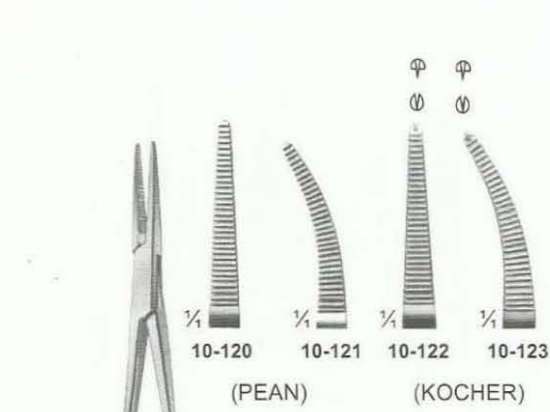

10-120 - 123
BABY-CRILE
140 mm

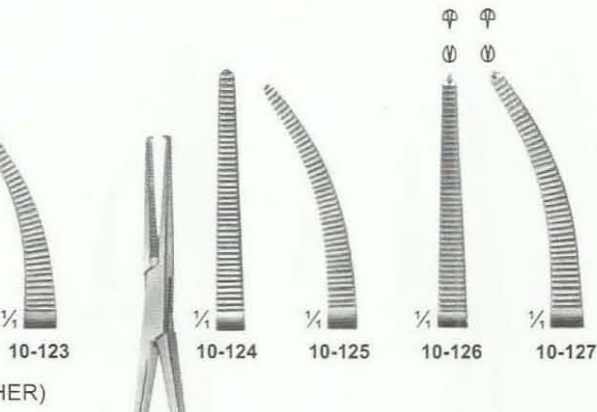

10-124 - 127
CRILE
140 mm

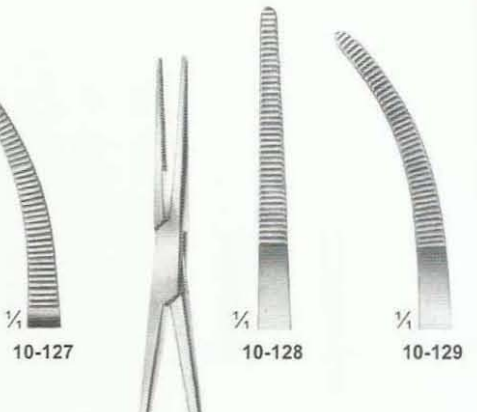

10-128 - 129
RANKIN
160 mm

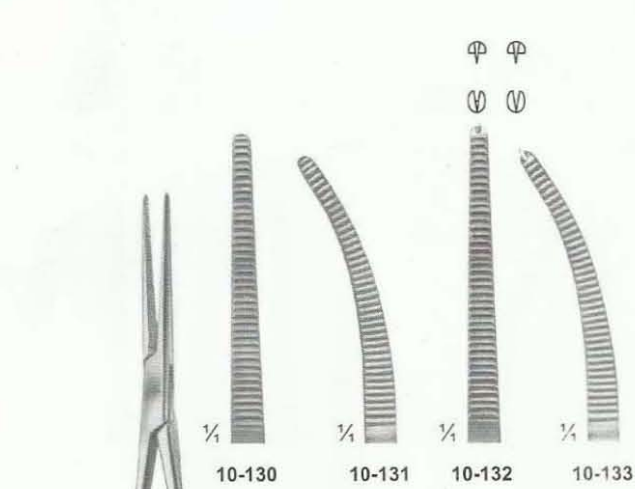

10-130 - 133
CRILE
160 mm

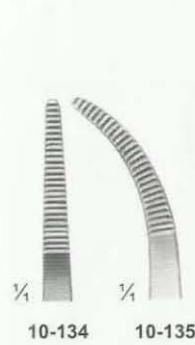

10-134 - 135
ADSON
185 mm

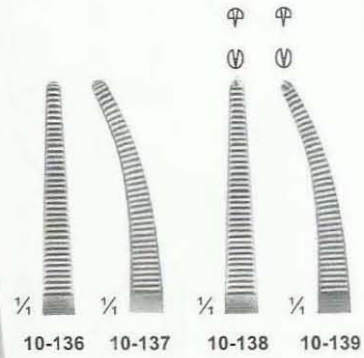

10-136 - 139
HALSTED
185 mm

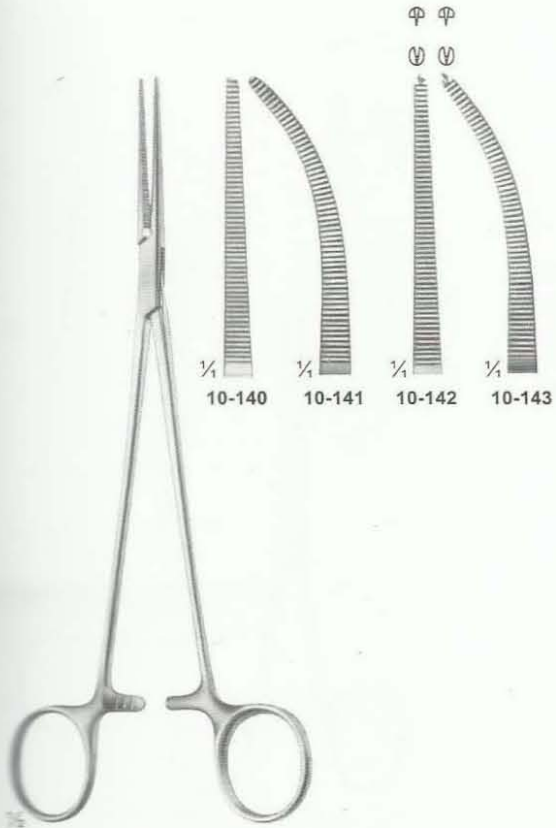

10-140 - 143
HALSTED-MOSQUITO
200 mm

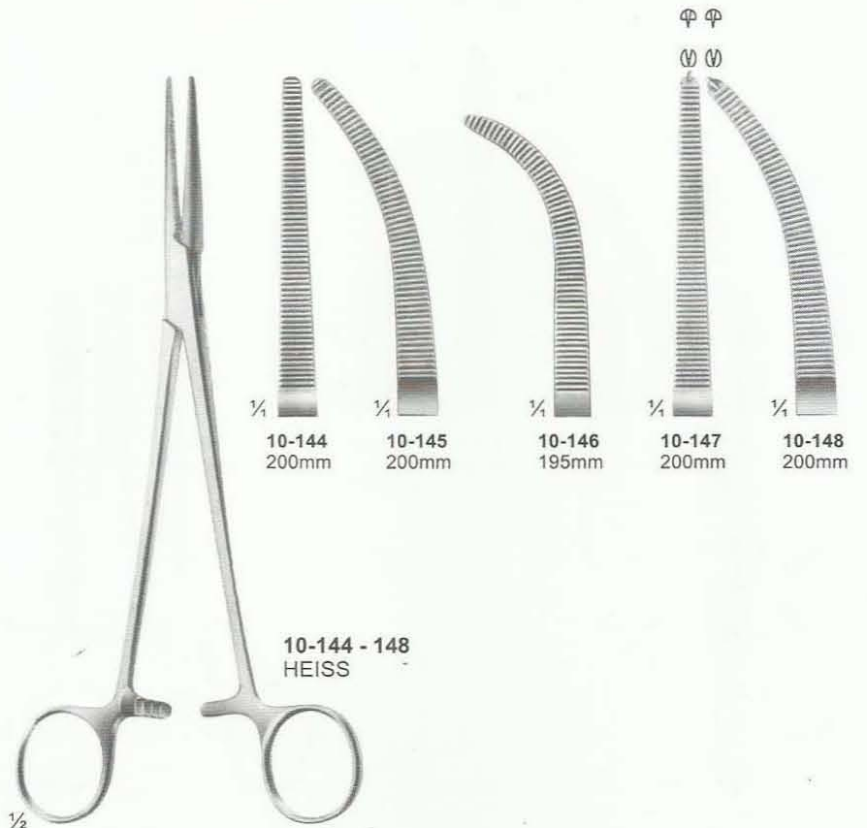

10-144 - 148
HEISS



10-149 - 150
HALSTED
215 mm

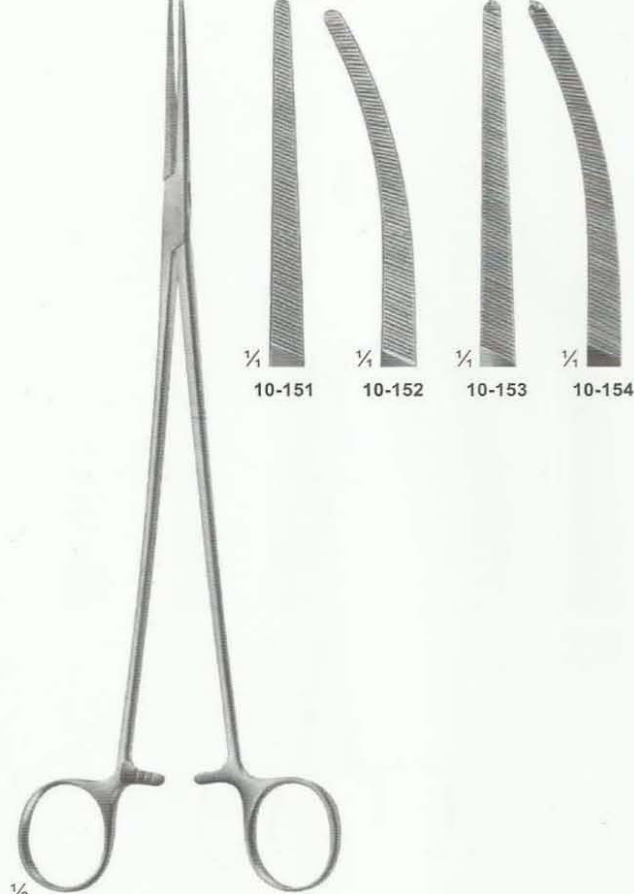

10-151 - 154
BENGOLEA
245 mm

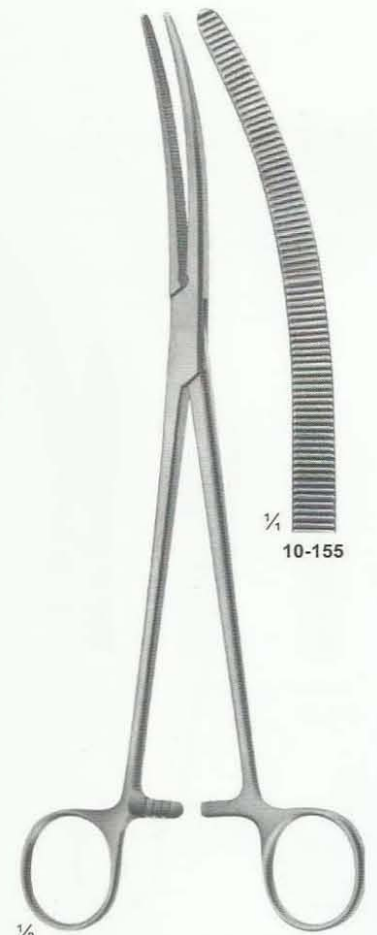

10-155
CRAFOORD
245 mm

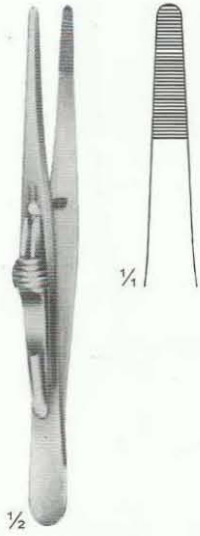

10-156
FRICKE
Artery forceps
130 mm

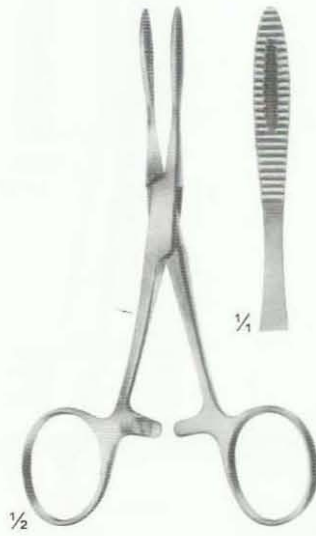

10-157
KRONLEIN
130 mm

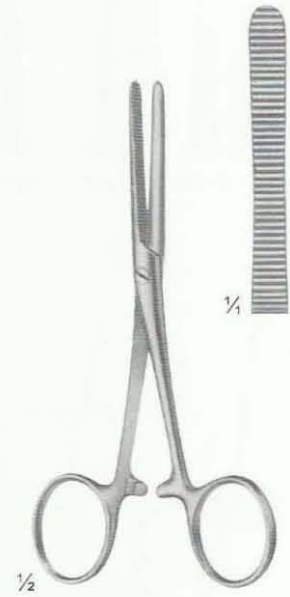

10-158
PEAN
125 mm

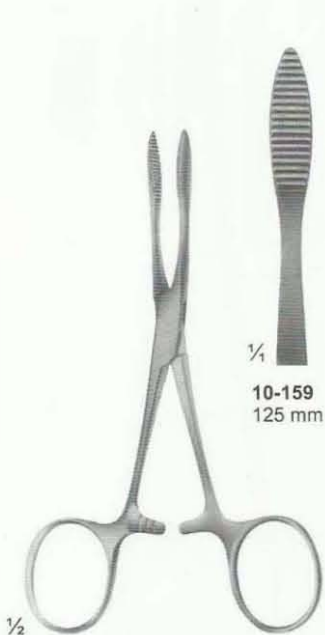

10-159 - 160
PEAN

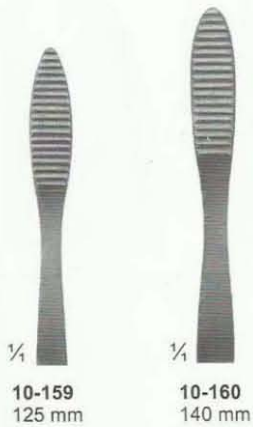

10-160
140 mm

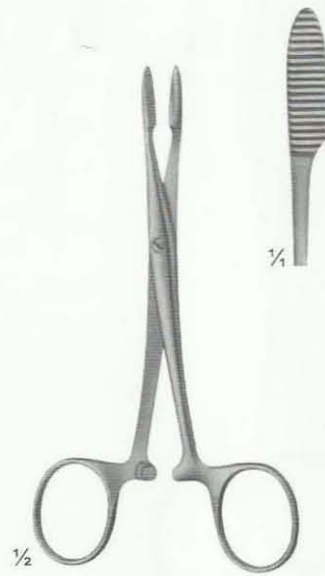

10-161
PEAN
125mm



10-162 - 163
PEAN

10-162
165 mm

10-163
185 mm

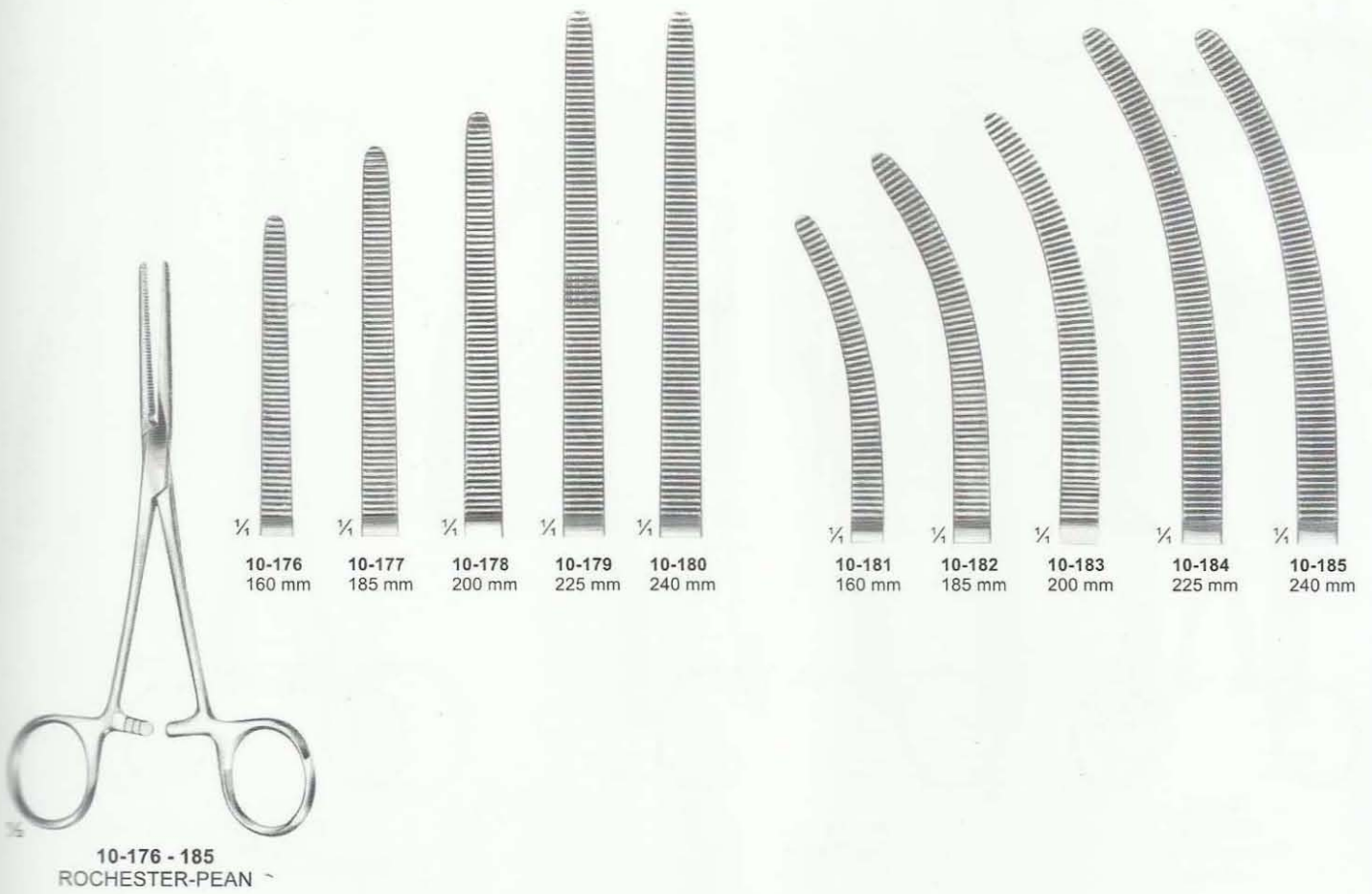
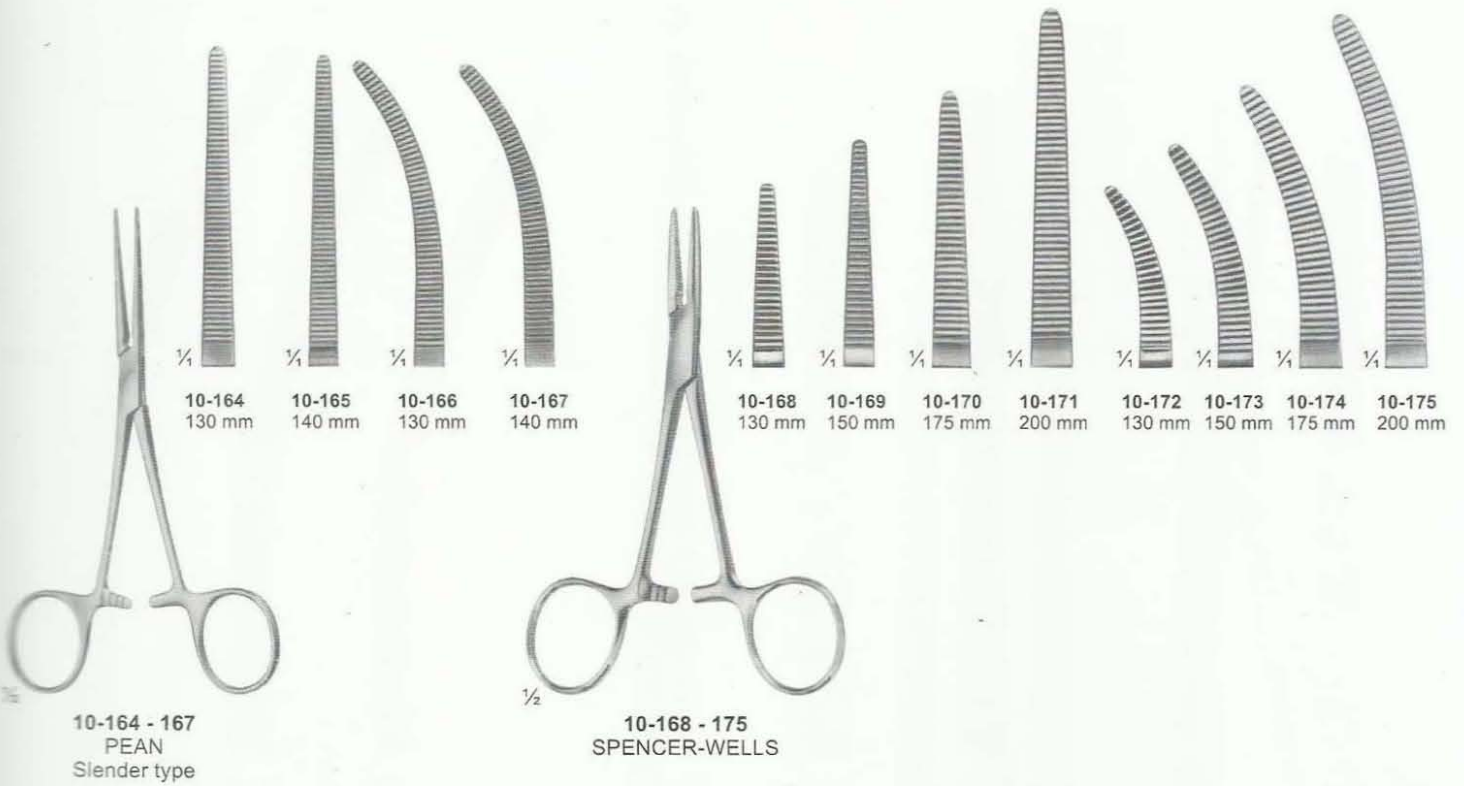



10-186 - 191
PEAN

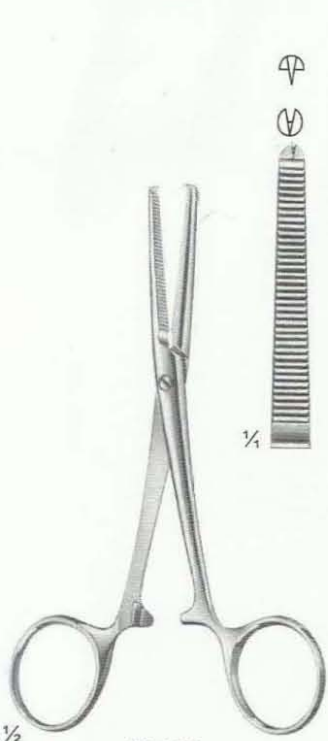
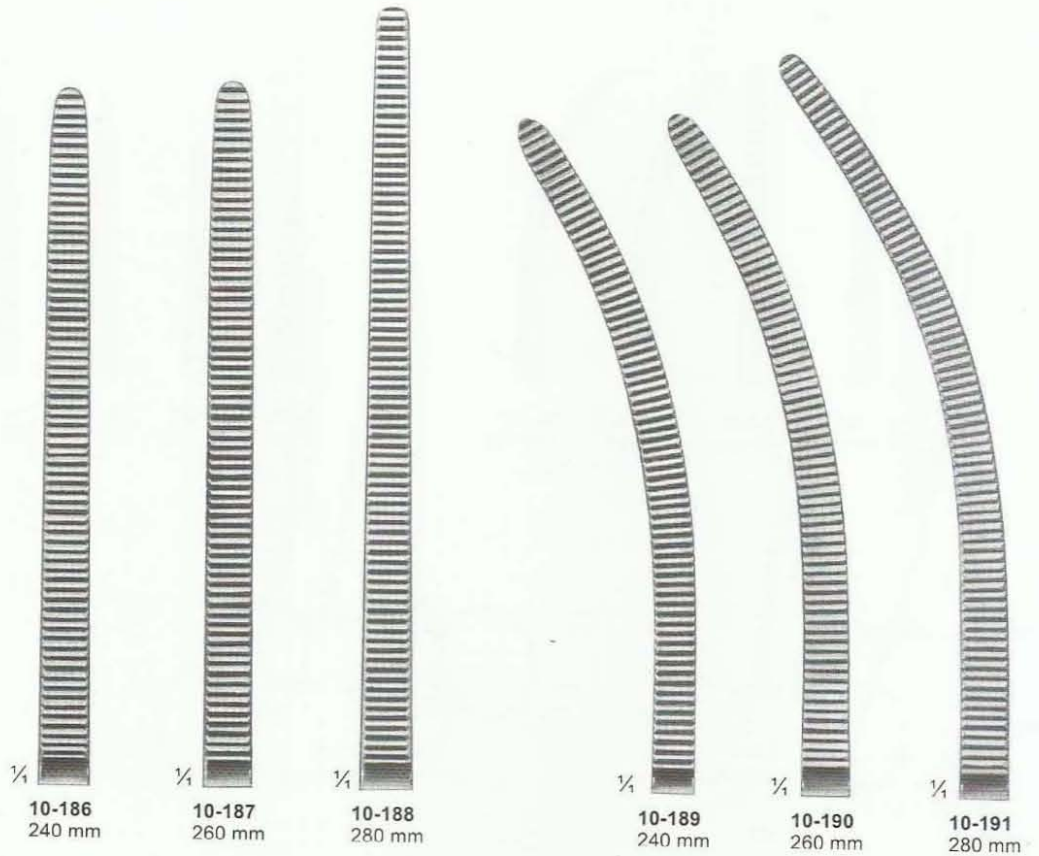

10-192
KOCHER
Strong Pättern
145 mm

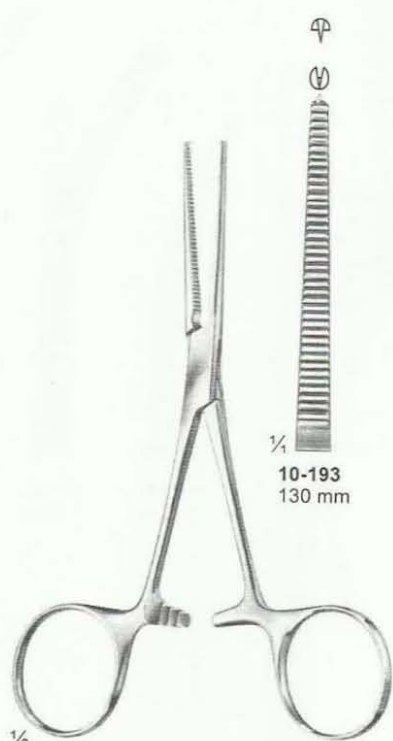

10-193 - 195
KOCHER

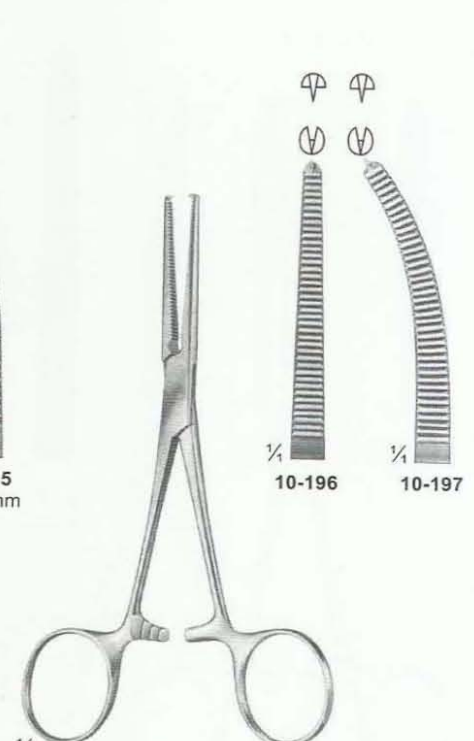

10-196 - 197
ROCHESTER-OCHSNER
140 mm

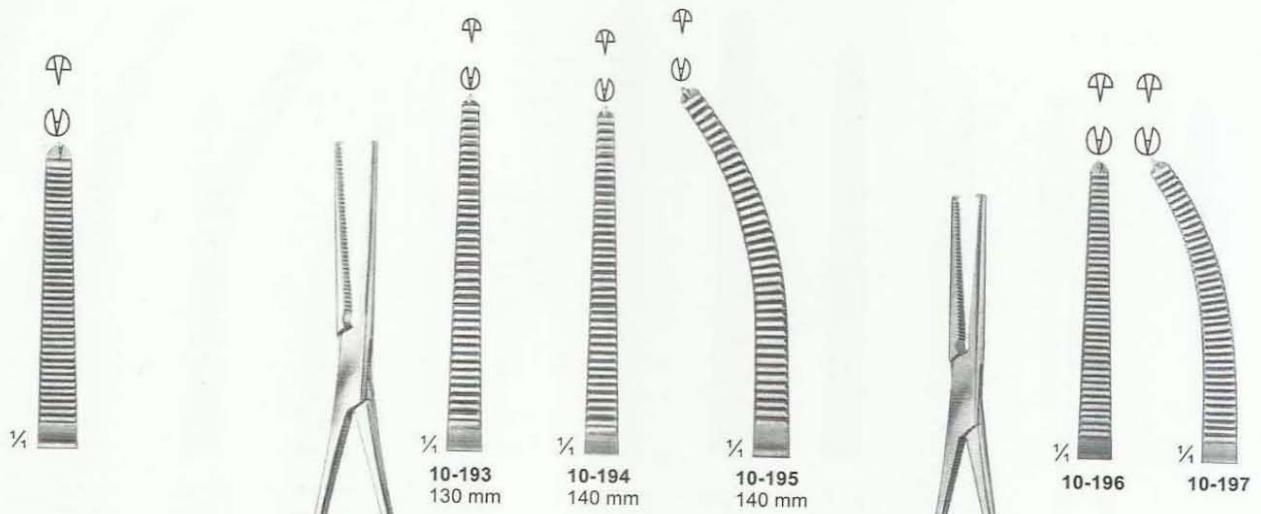

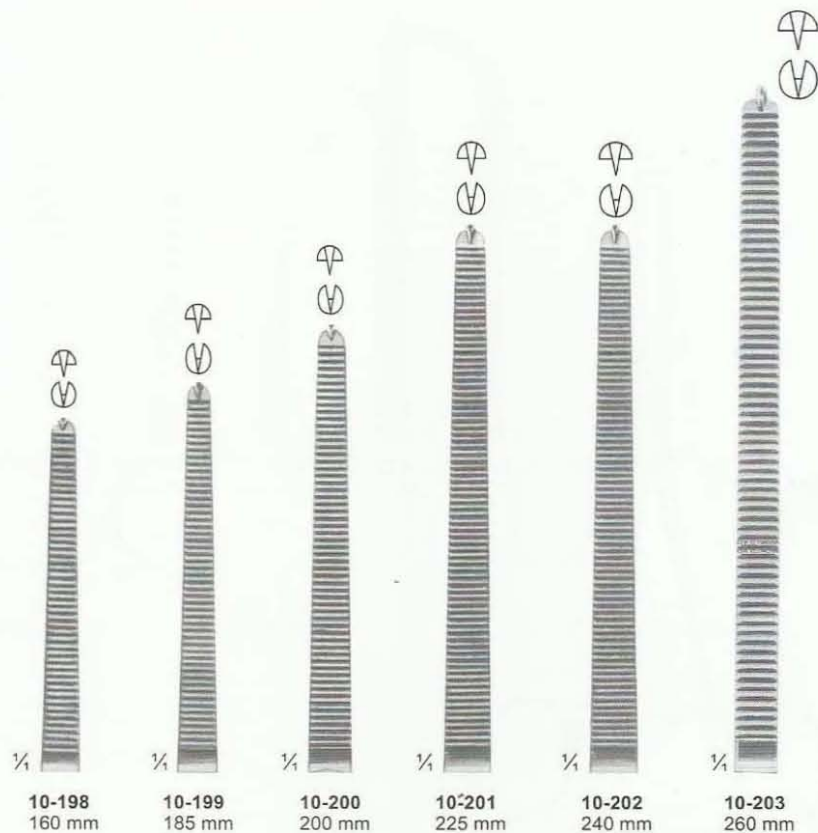

10-198 - 209
KOCHER-OCHSNER

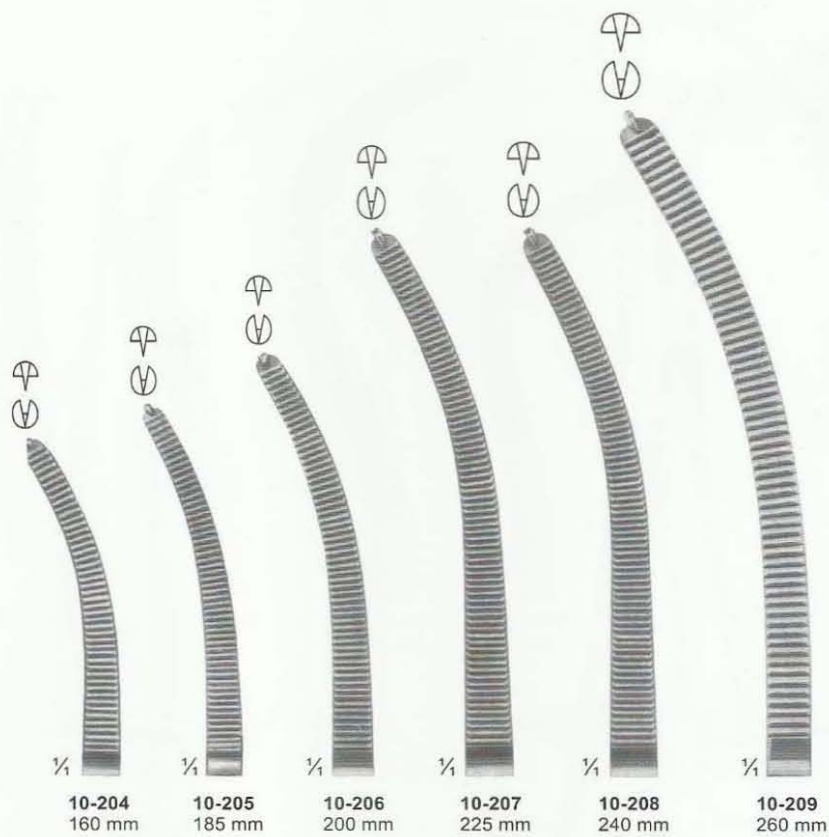



10-210 - 213
ROCHESTER-CARMALT

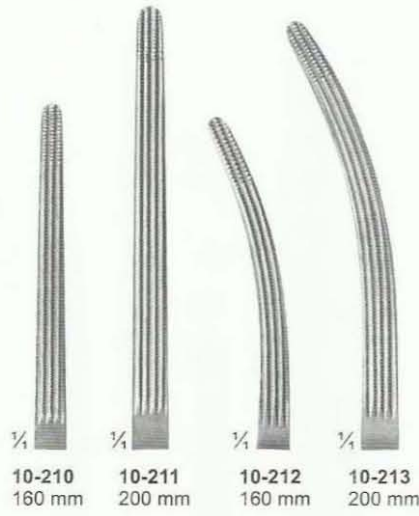

10-214 - 215
MOYNIHAN

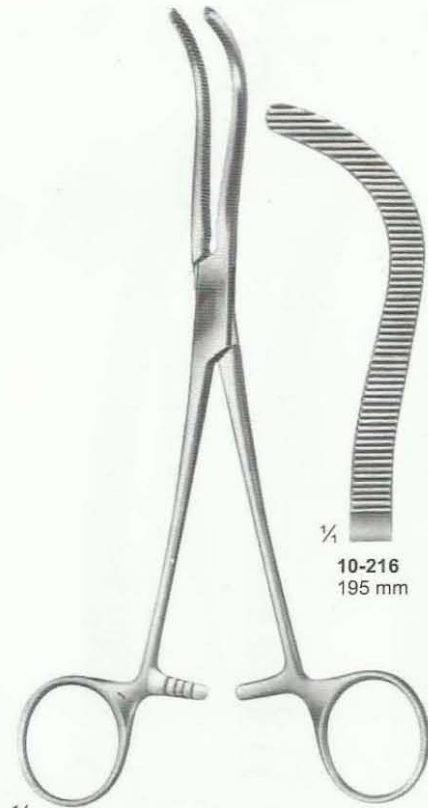
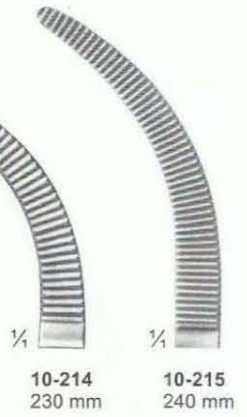

10-216 - 218
PEAN



10-219 - 220
NEGUS
190 mm

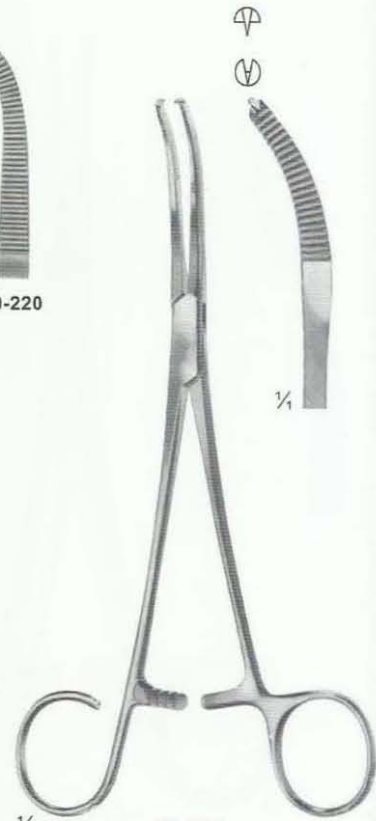
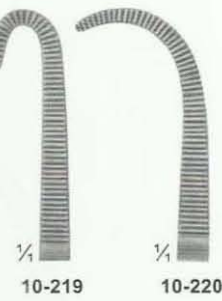

10-221
MIKULICZ
185 mm



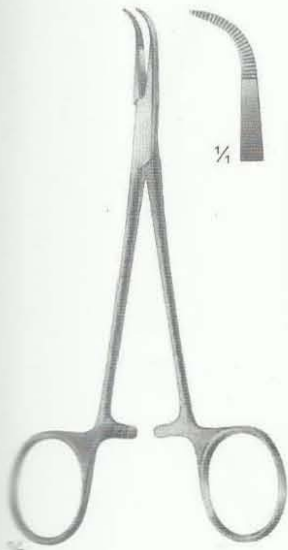

10-222
MICRO-ADSON
140 mm



10-223
BABY-OVERHOLT
135 mm



10-224 - 225
BABY-MIXTER

10-224
140 mm

10-225
180 mm



10-226 - 227
BABY-ADSON

10-226
140 mm

10-227
180 mm



10-228
NISSEN

10-228
185 mm



10-229 - 230
YASARGIL
195 mm

10-229

10-230

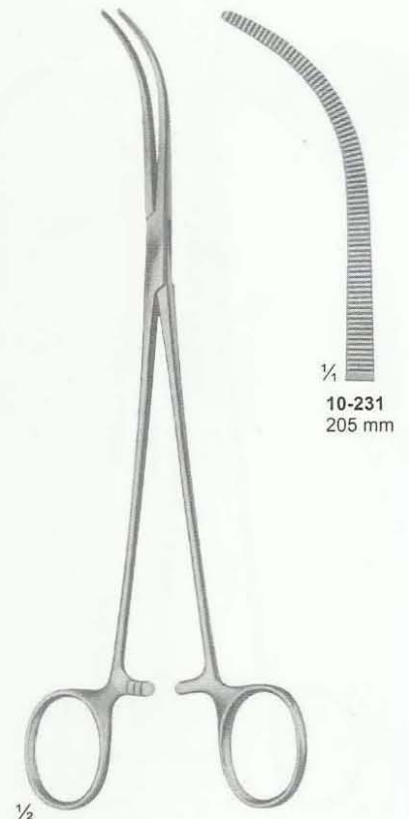

10-231
OVERHOLT-MIXTER

10-231
205 mm

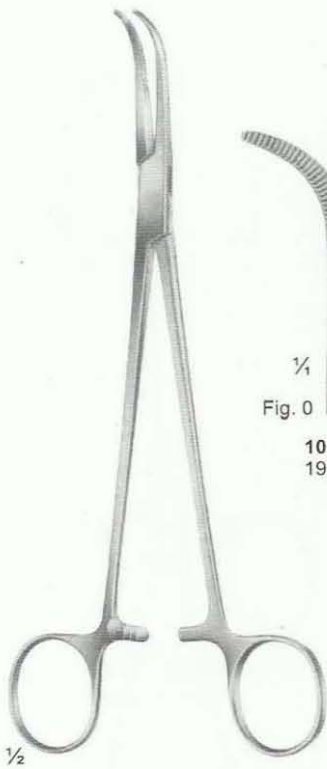

10-232 - 243
OVERHOLT-GEISSENDOERFER

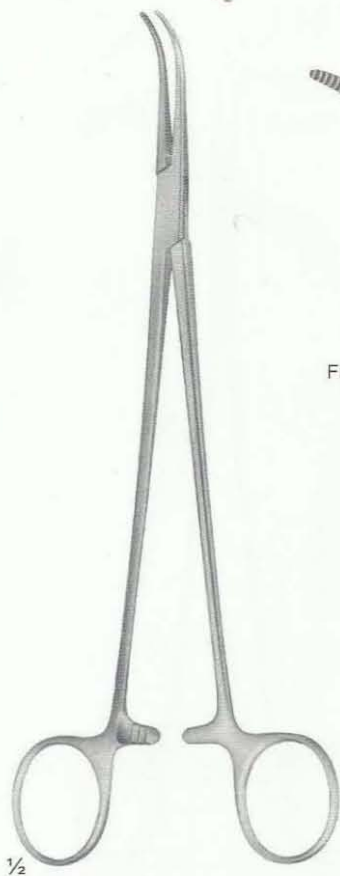
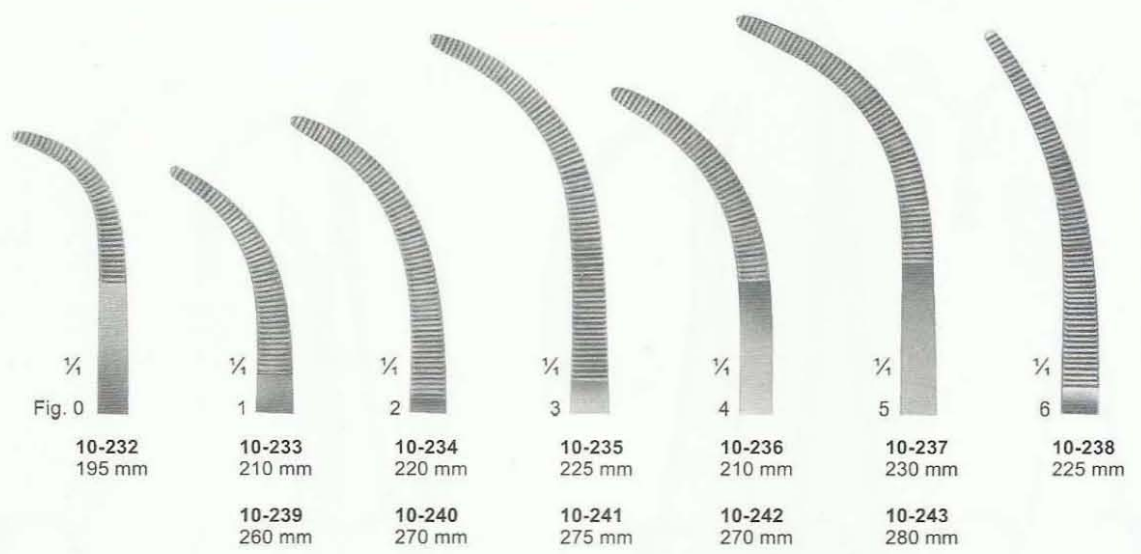

10-244 - 251
OVERHOLT
fine pattern

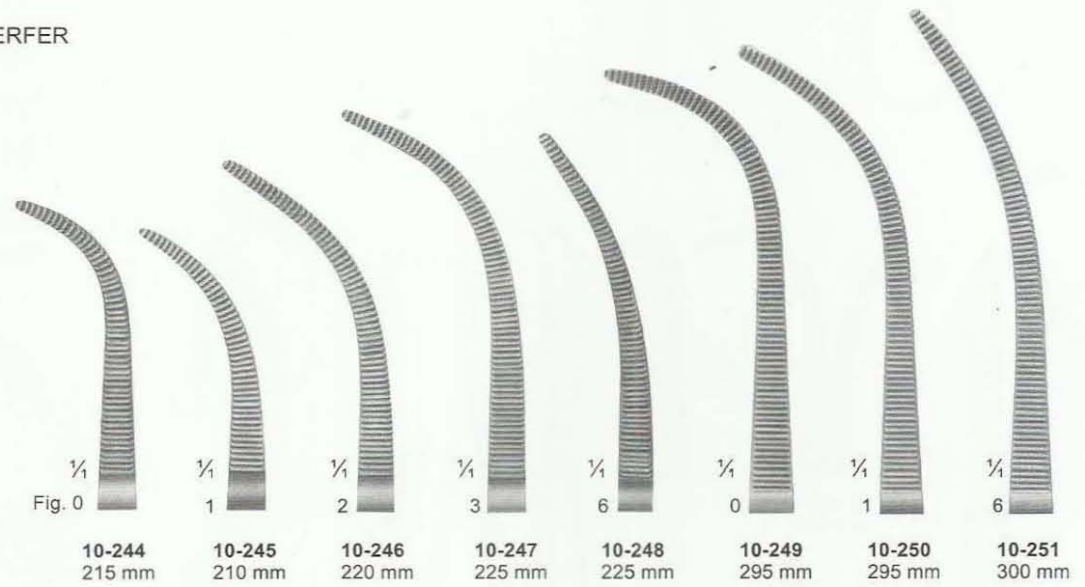

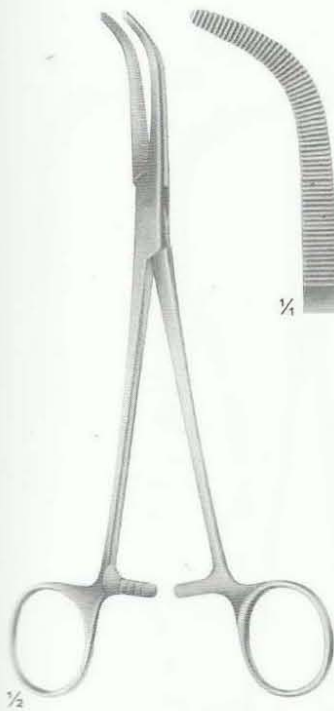

10-252
MIXTER-O'SHAUGHNESSY
190 mm

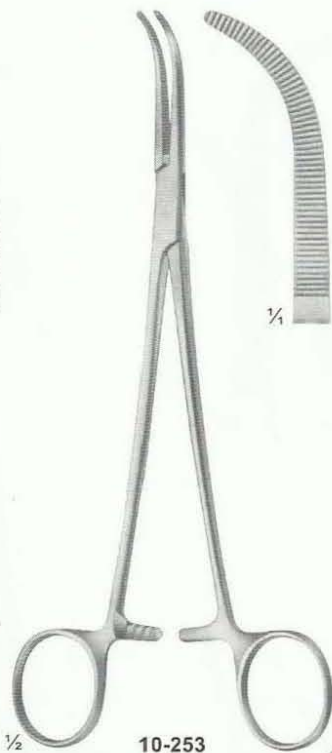

10-253
HEISS
195 mm

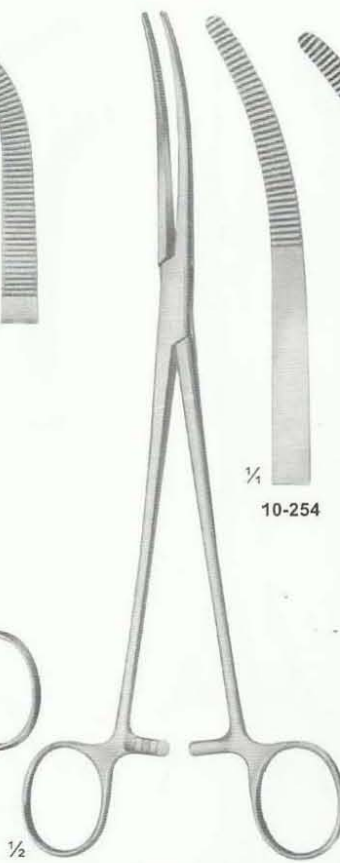

10-254 - 258
RUMEL
240 mm

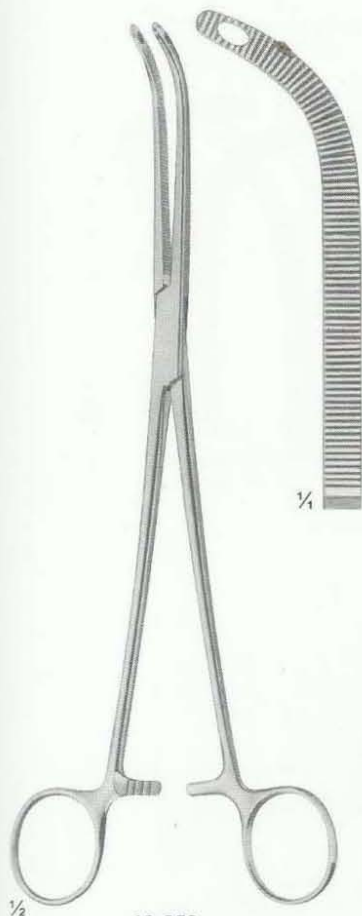
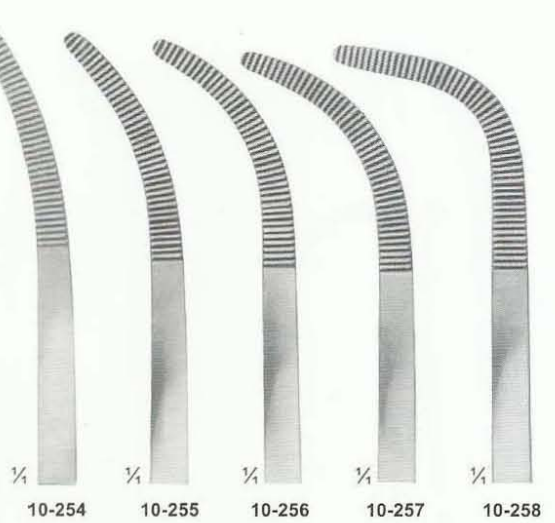

10-259
FINOCHIETTO
245 mm

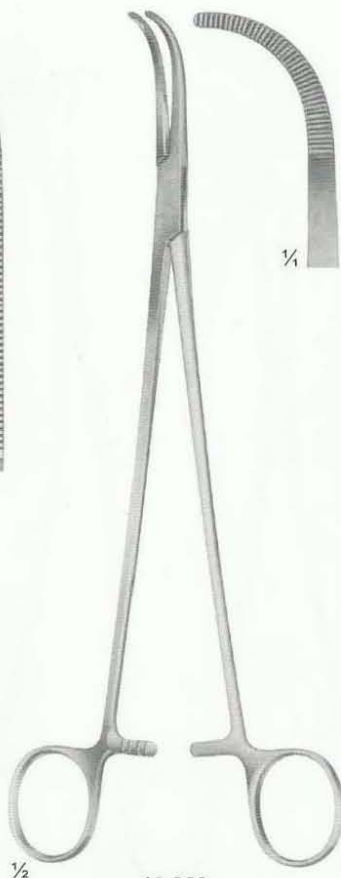

10-260
MIXTER
230 mm



10-261
LAWRENCE
270 mm

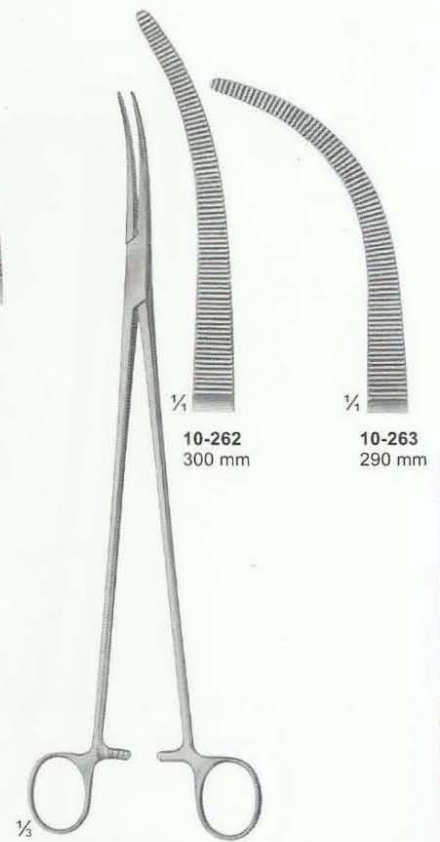

10-262 - 263
ZENKER

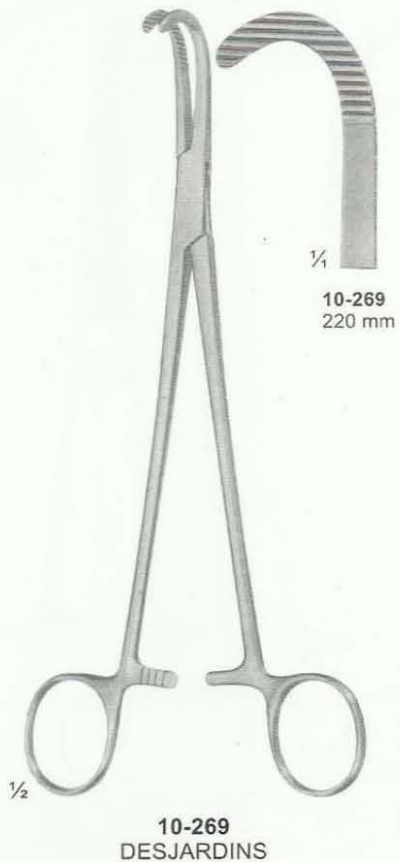

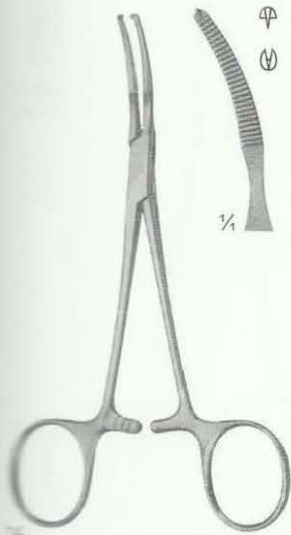

10-272
BABY-MIKULICZ
140 mm

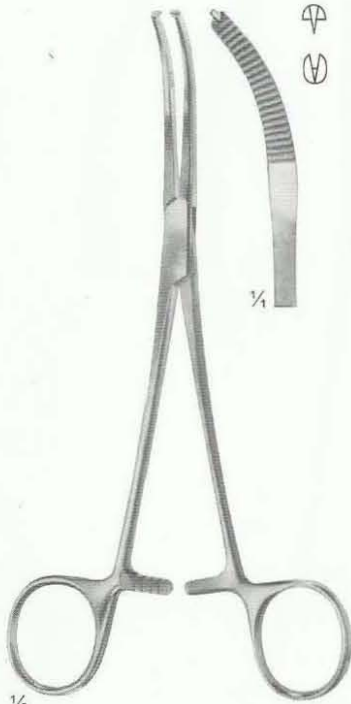

10-273
MIKULICZ
185 mm

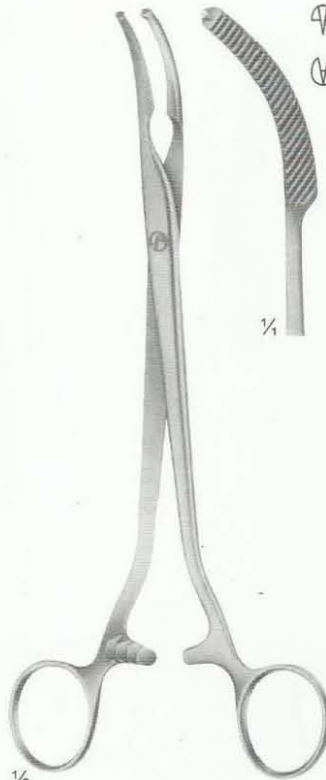

10-274
MIKULICZ
205 mm

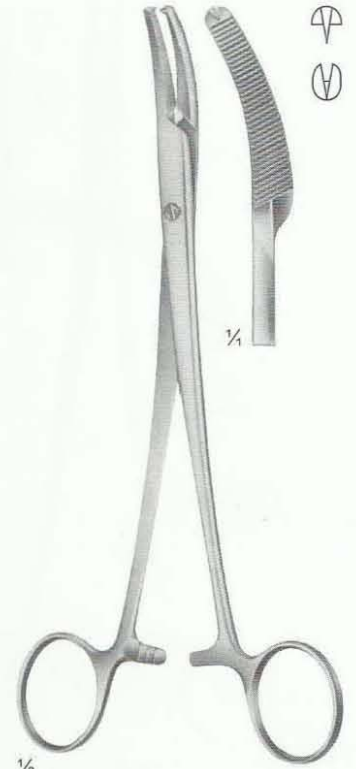

10-275
MIKULICZ
200 mm

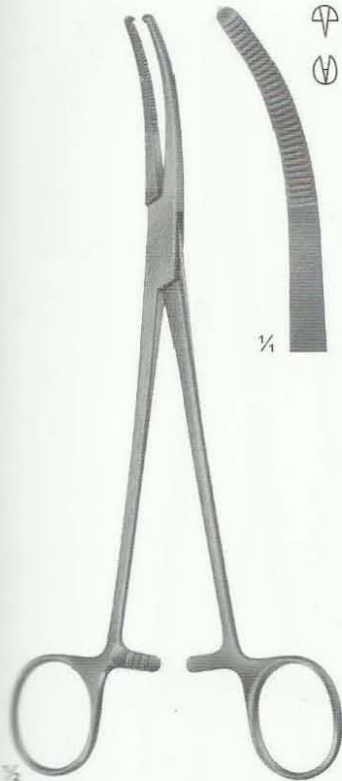

10-276
MIKULICZ
205 mm

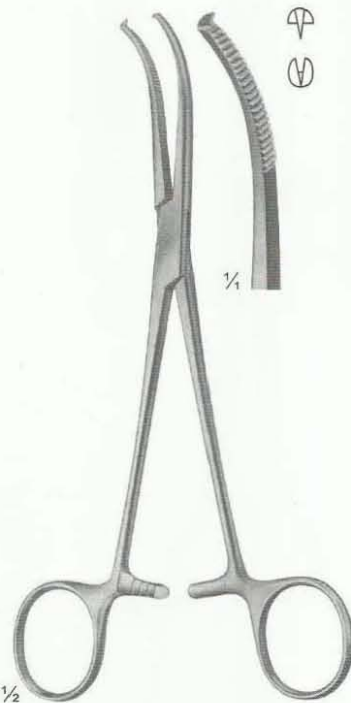

10-277
MIKULICZ
185 mm

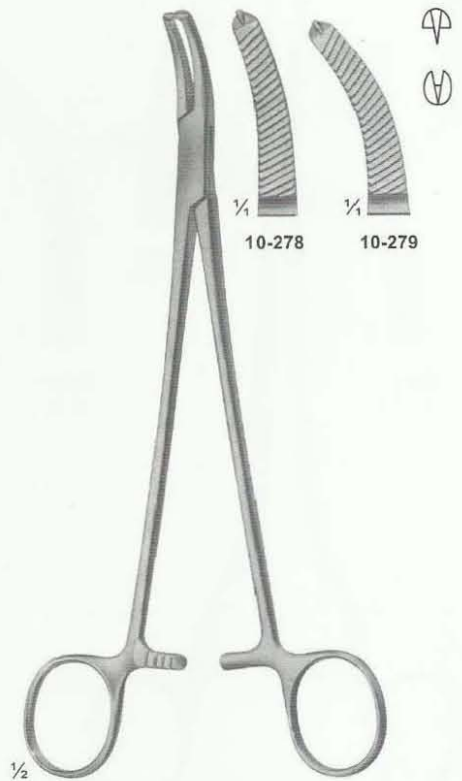

10-278 - 279
FAURE
205 mm

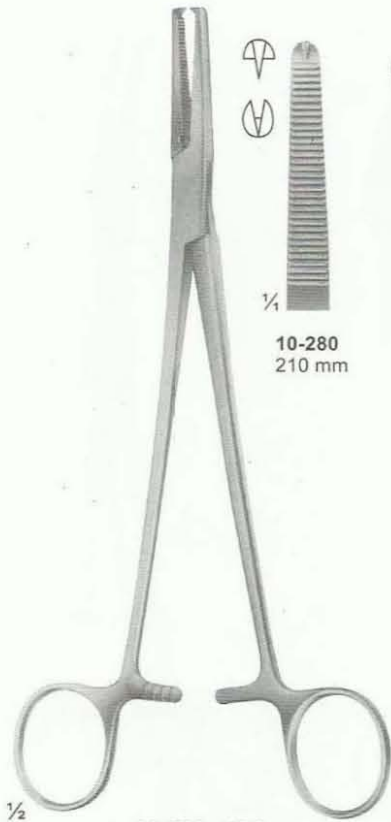

10-280 - 281
PHANEUF

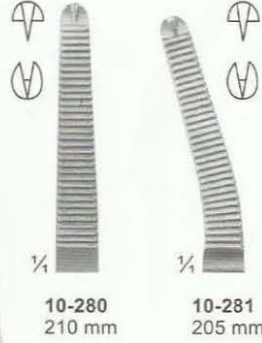

10-282 - 283
HEANEY modif.

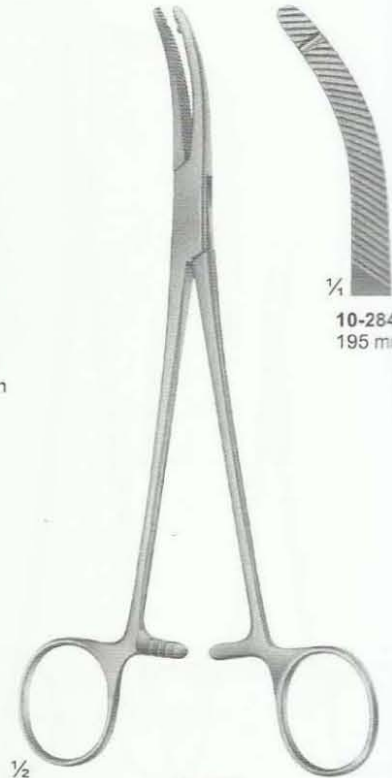

10-284
HEANEY

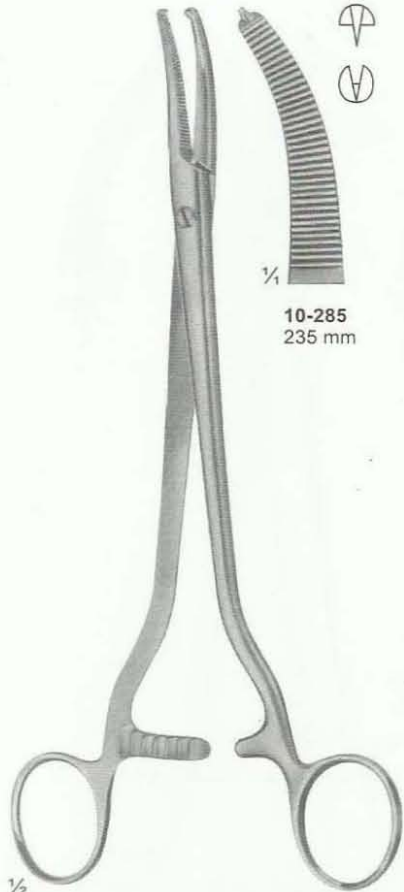

10-285
WERTHEIM

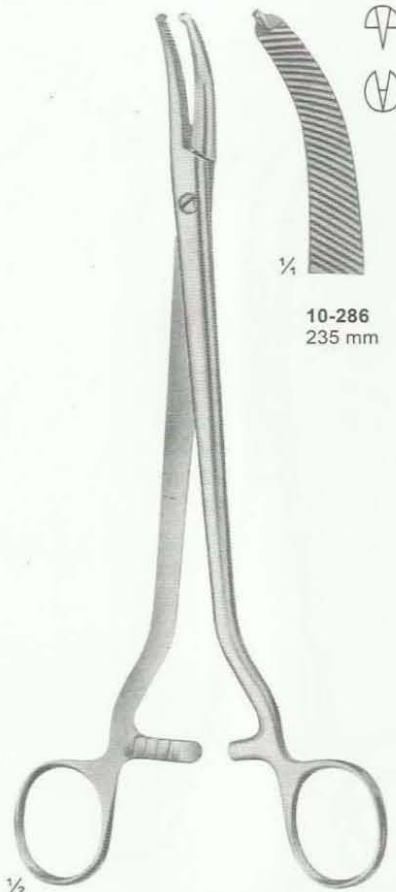

10-286
WERTHEIM



10-287
WERTHEIM





10-288 - 291
HEANEY



10-288
225 mm



10-289
220 mm



10-290
215 mm



10-291
205 mm



10-292 - 295
WERTHEIM
Parametrium clamps



10-292
250 mm



10-293
245 mm



10-294
240 mm



10-295
220 mm

ATRAUMATA



10-296
WERTHEIM
Hysterectomy Forceps
255 mm

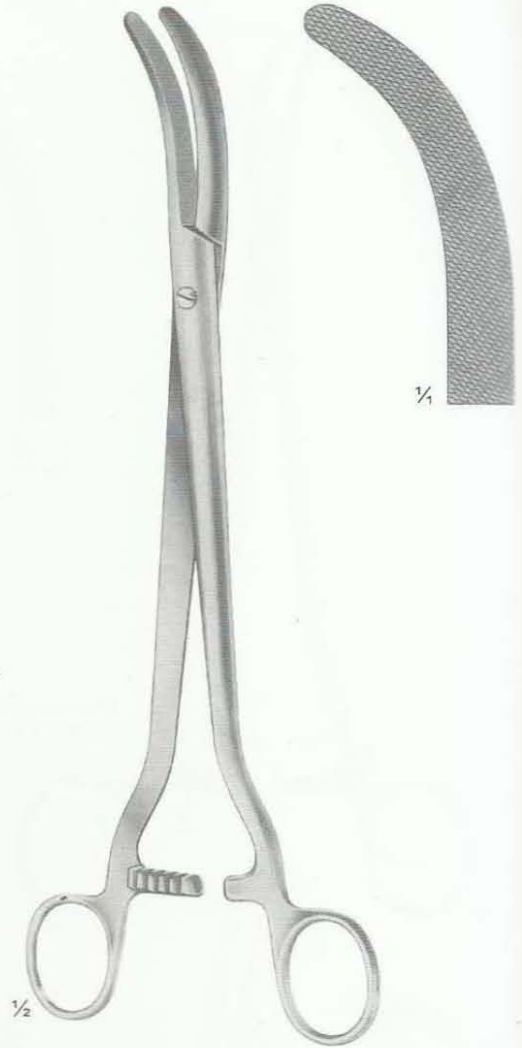

10-297
WERTHEIM
Parametrium Clamp
260 mm

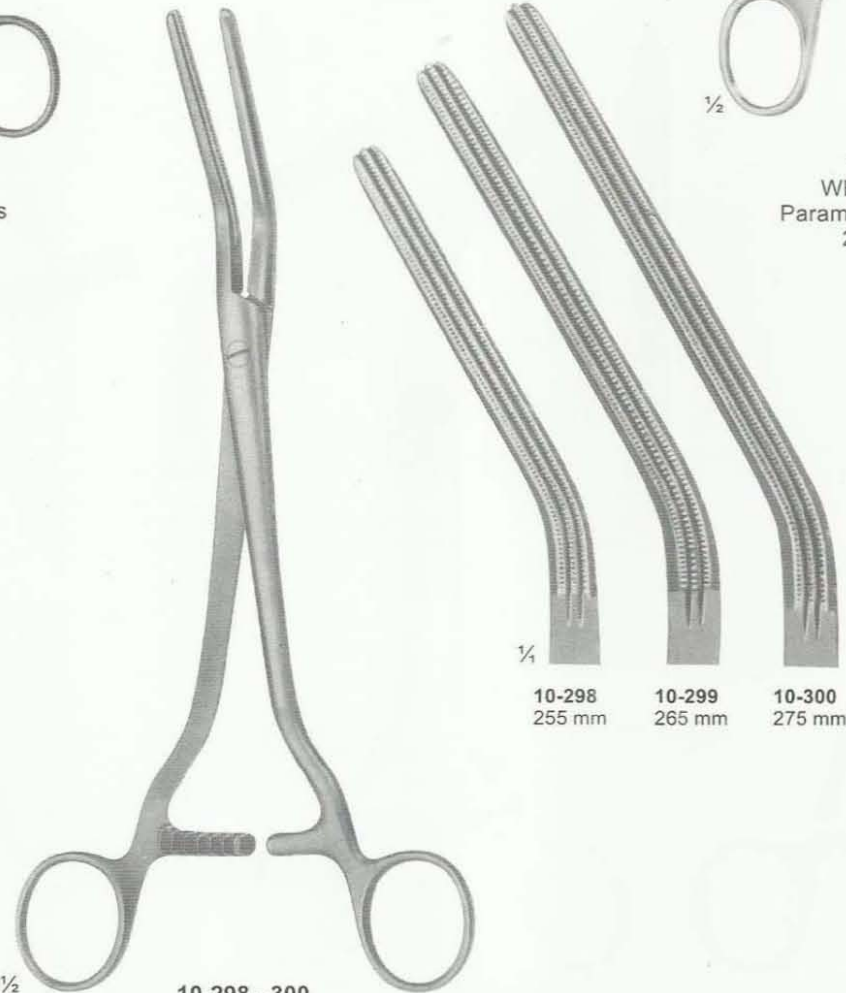

10-298 - 300
DICK

10-298 255 mm
10-299 265 mm
10-300 275 mm

ATRAUMATA



10-301
WERTHEIM
250 mm



1/4

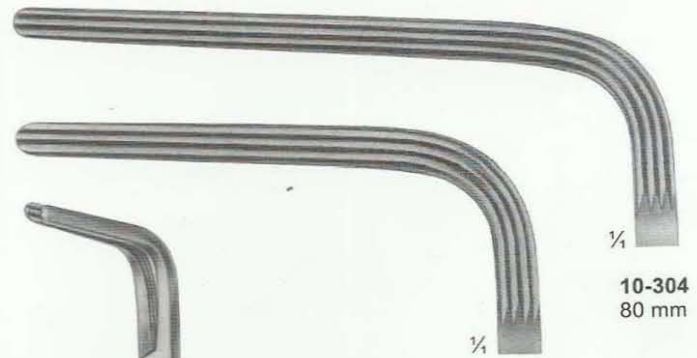

10-304
80 mm

1/4

10-303
60 mm



1/2

10-303 - 304
230 mm



1/2

10-302
WERTHEIM-CULLEN
215 mm

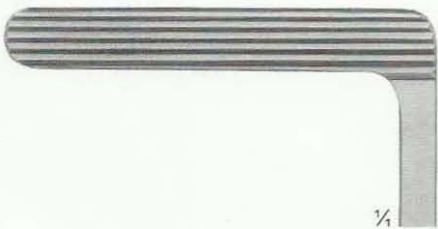

1/4

	SECTION	PAGE
Needle Holders	11	96-101
Suture Instruments		
Probes, Pocket Instruments Set		102-114

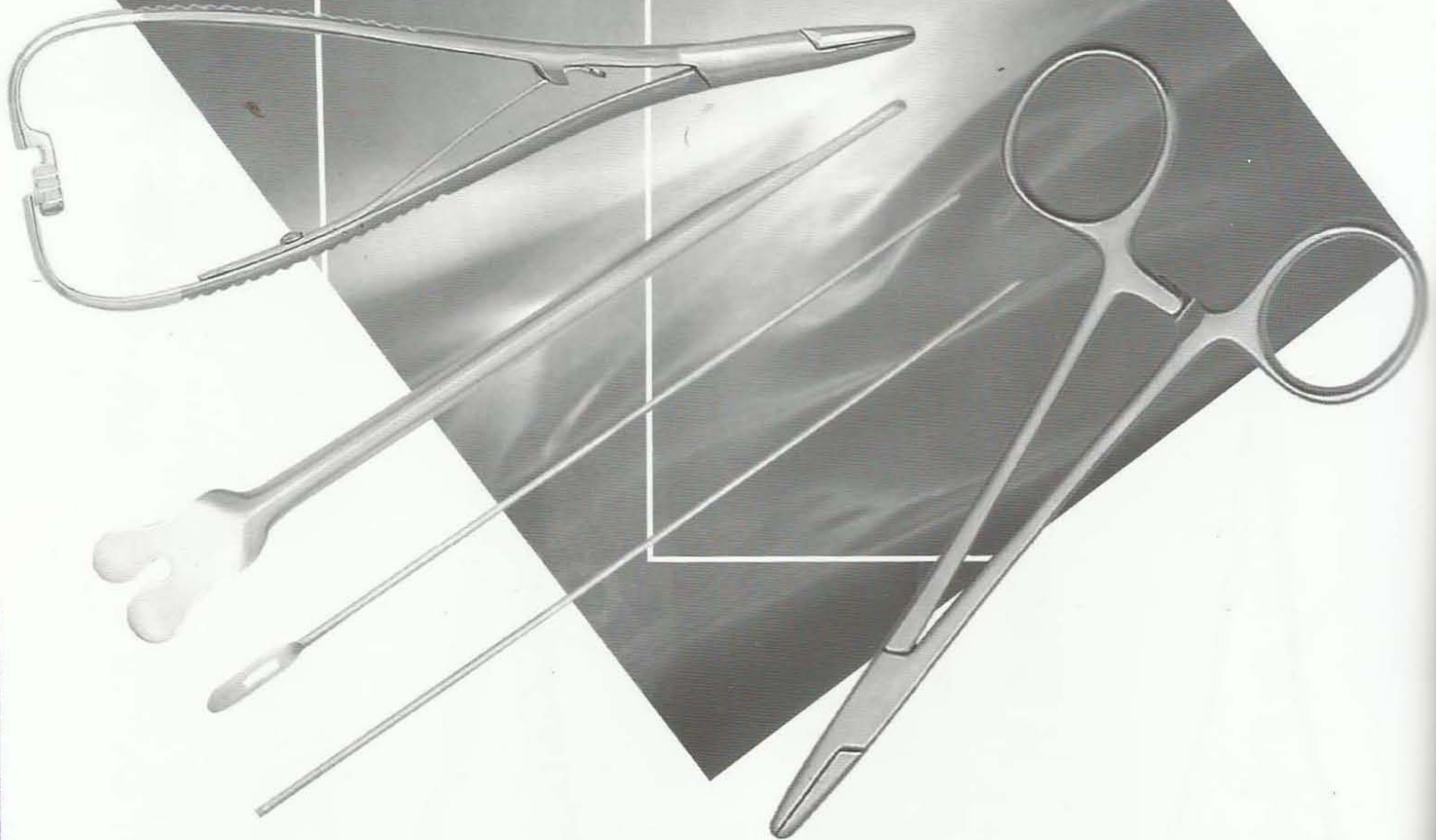



11-101
ROHRSCHEIDER
With copper inserts
100 mm



11-102
KALT
With catch
135 mm



11-103
ARRUGA
With catch
135 mm



11-104 - 105
CASTROVIEJO
With catch
145 mm



11-106 - 107
CASTROVIEJO
With Catch
160 mm



11-108 - 109
Without catch
185 mm



11-109



11-110 - 111
JACOBSON
185 mm

11-110
Without catch

11-111
With catch



11-112
Without catch
195 mm



11-113 - 114
YASARGIL
With catch
200 mm

11-113

11-114



11-115 116
BARRAQUER
Without catch



11-117 - 118
BARRAQUER
Without catch
120 mm



11-119 - 120
BARRAQUER
With catch
120 mm



11-121 - 122
BARRAQUER
With Catch
150 mm



11-123
MULLER
With Locking
Mechanism
145 mm



11-126 - 127
YASARGIL
200 mm



11-128 - 129
YASARGIL
225 mm



11-130
YASARGIL
245 mm

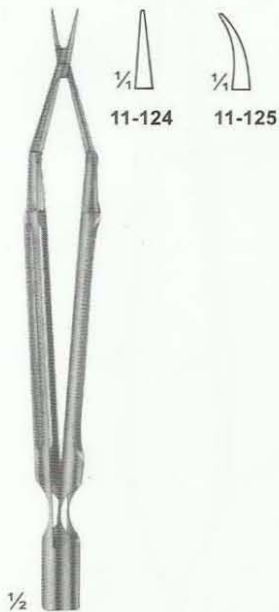

11-124 - 125
BROCK
Without catch
150 mm

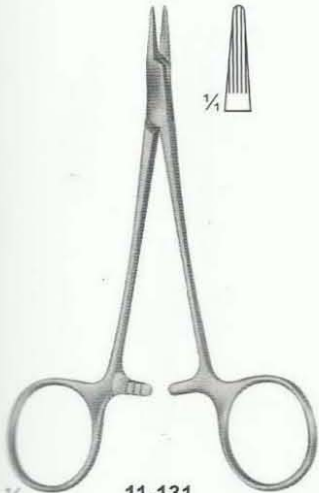

11-131
CONVERSE
125 mm

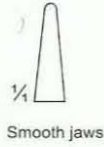

11-132
WEBSTER
125 mm

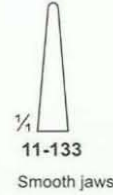
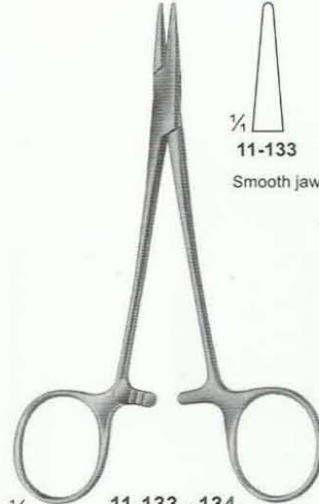

11-133 - 134
HALSEY
130 mm



11-135
DERF
125 mm



11-136
DOYEN
125 mm

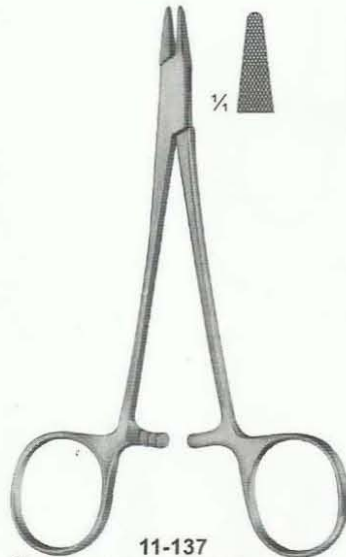

11-137
BAUMGARTNER
145 mm

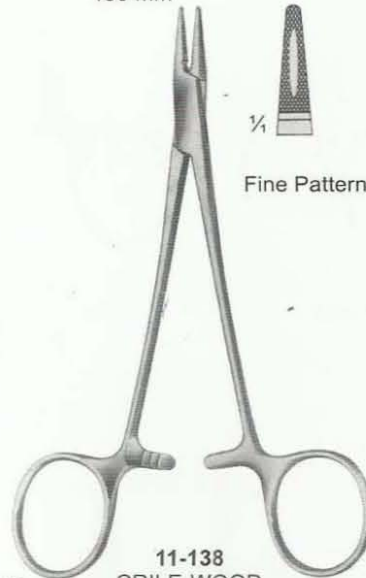

Fine Pattern

11-138
CRILE-WOOD
150 mm

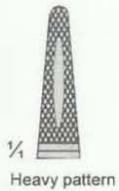

Heavy pattern

11-139
CRILE-WOOD
160 mm

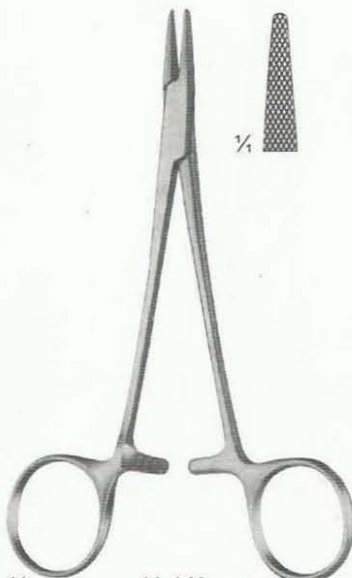

11-140
CRILE-MURRAY
150 mm

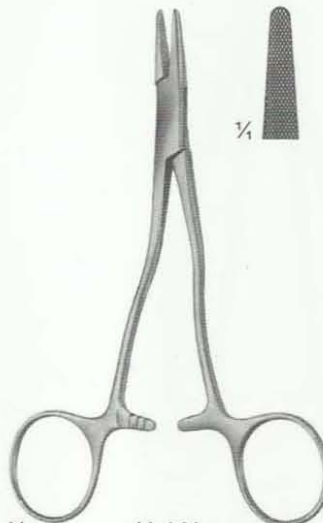

11-141
KILNER
135 mm

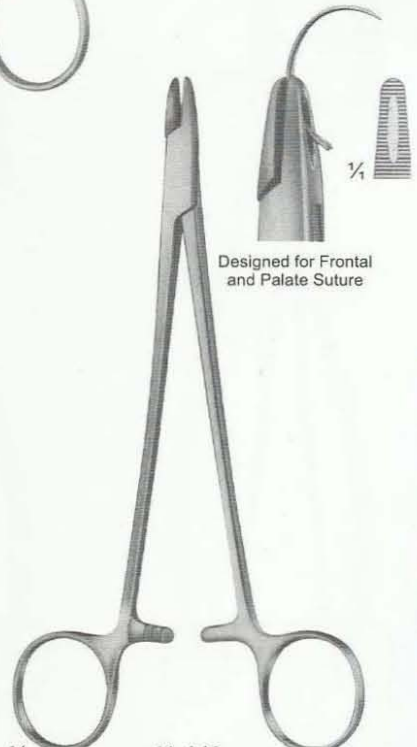

Designed for Frontal
and Palate Suture

11-142
ADSON
175 mm

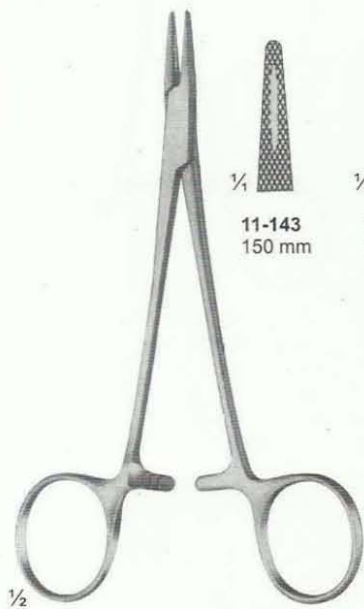

11-143 - 145
MAYO-HEGAR
Medium fine patterns

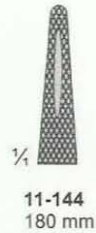

11-146 - 149
HEGAR
Heavy Patterns

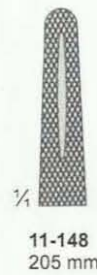

11-150
HEANEY (HEGAR)
200 mm

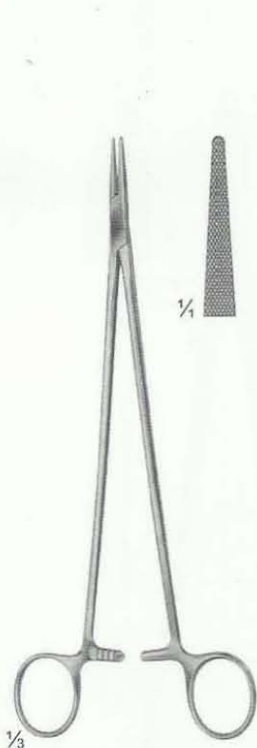

11-151
JAMESON
230 mm

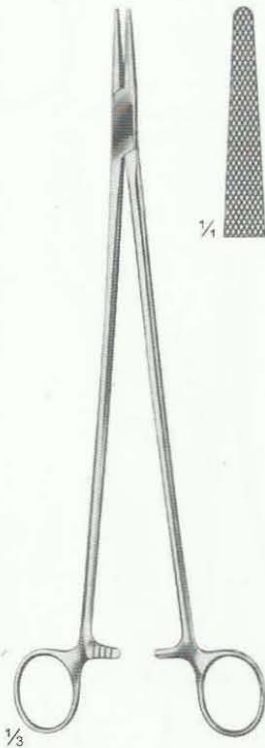

11-152
WANGENSTEEN
275 mm



11-153
MASSON
265 mm

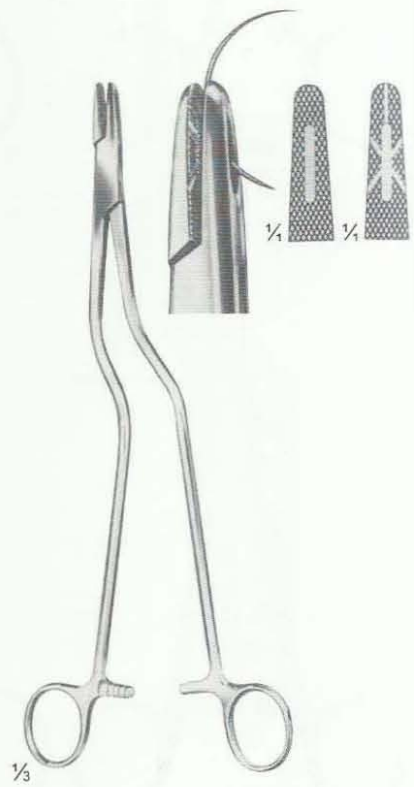

11-154
MASSON-LUETHY
255 mm

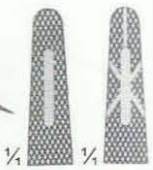

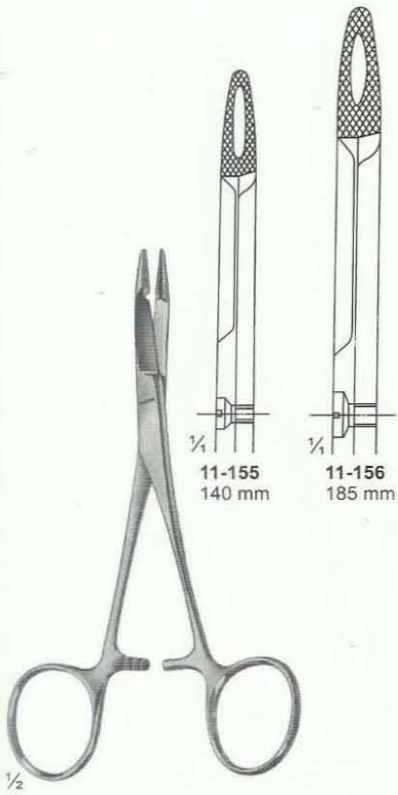

11-155 - 156
HEGAR-OLSEN
Needle Holders with Scissors

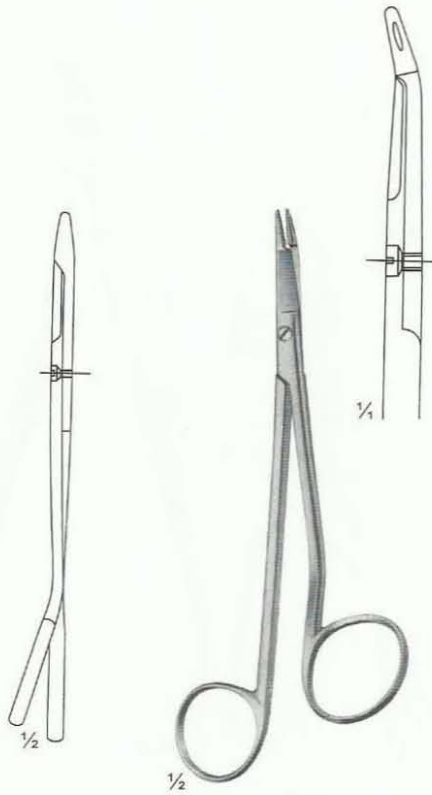

11-157
GILLIES
Needle Holders with Scissors
150 mm

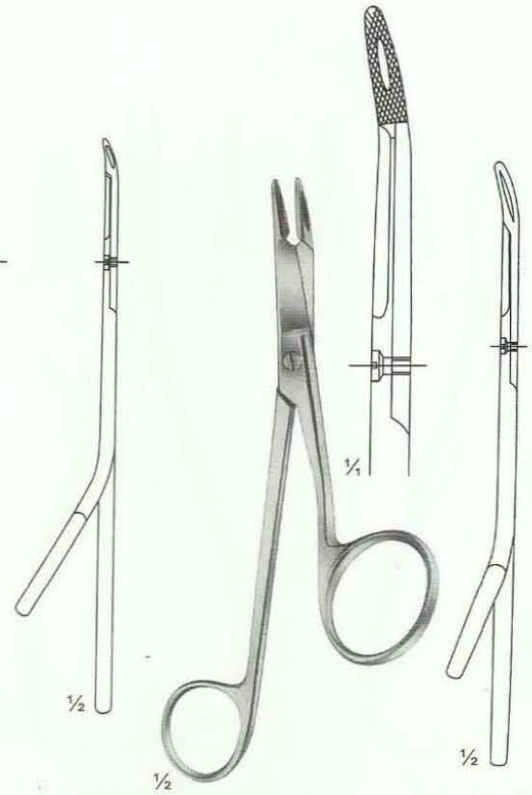

11-158
GILLIES
Needle Holders with Scissors
160 mm

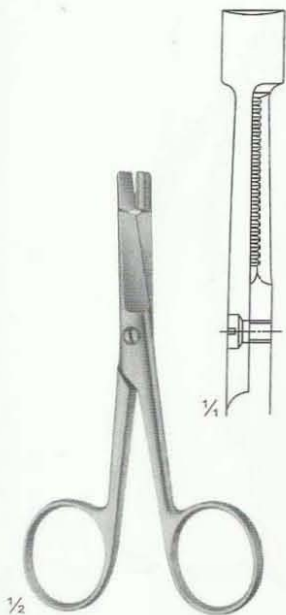

11-159
EISELSBERG
Needle Holders with Scissors
115 mm

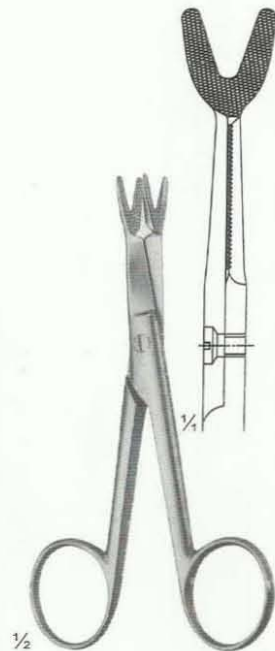

11-160
SCHOEMAKER-LOTH
Needle Holders with Scissors
125 mm



11-161
CRILE
150 mm



11-162
TOENNIS
Elastic pattern for
dura-or intestinal suture
180 mm

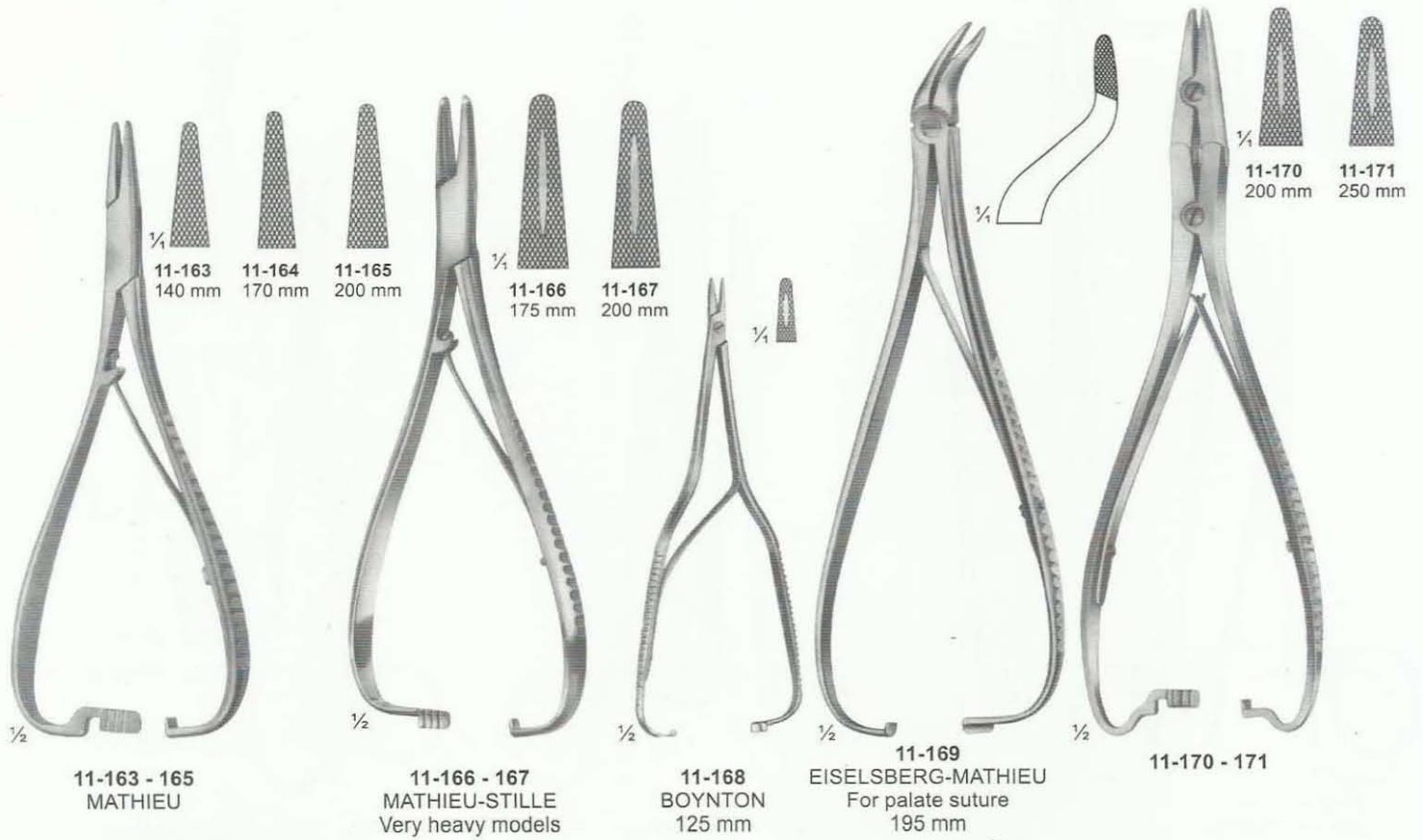

Spare Needles

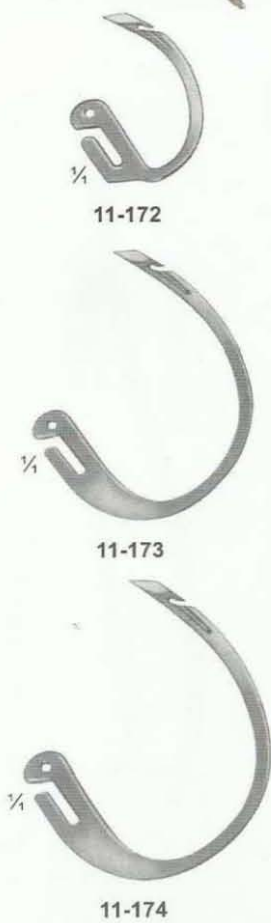

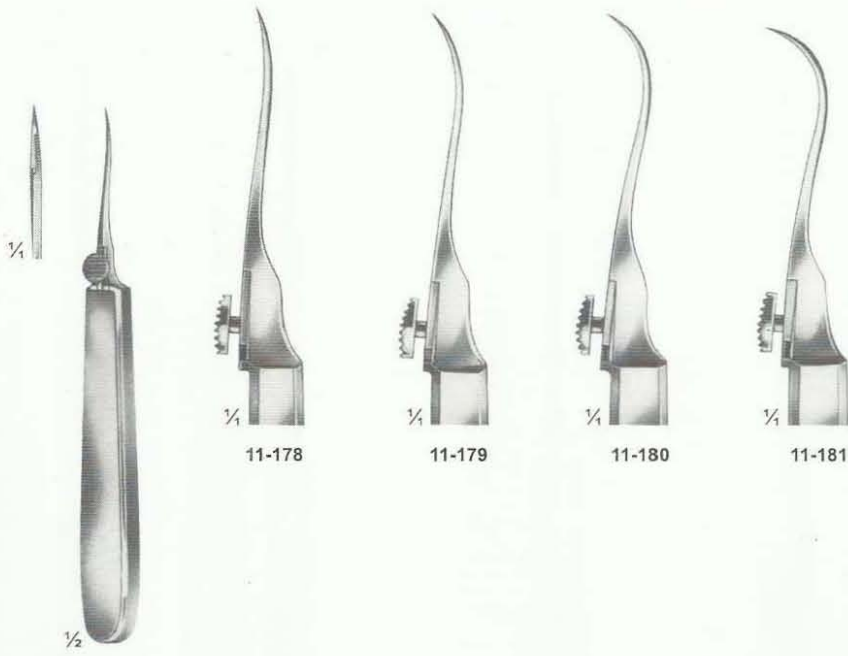

11-178

11-179

11-180

11-181

11-178 - 181
REVERDIN
140 mm

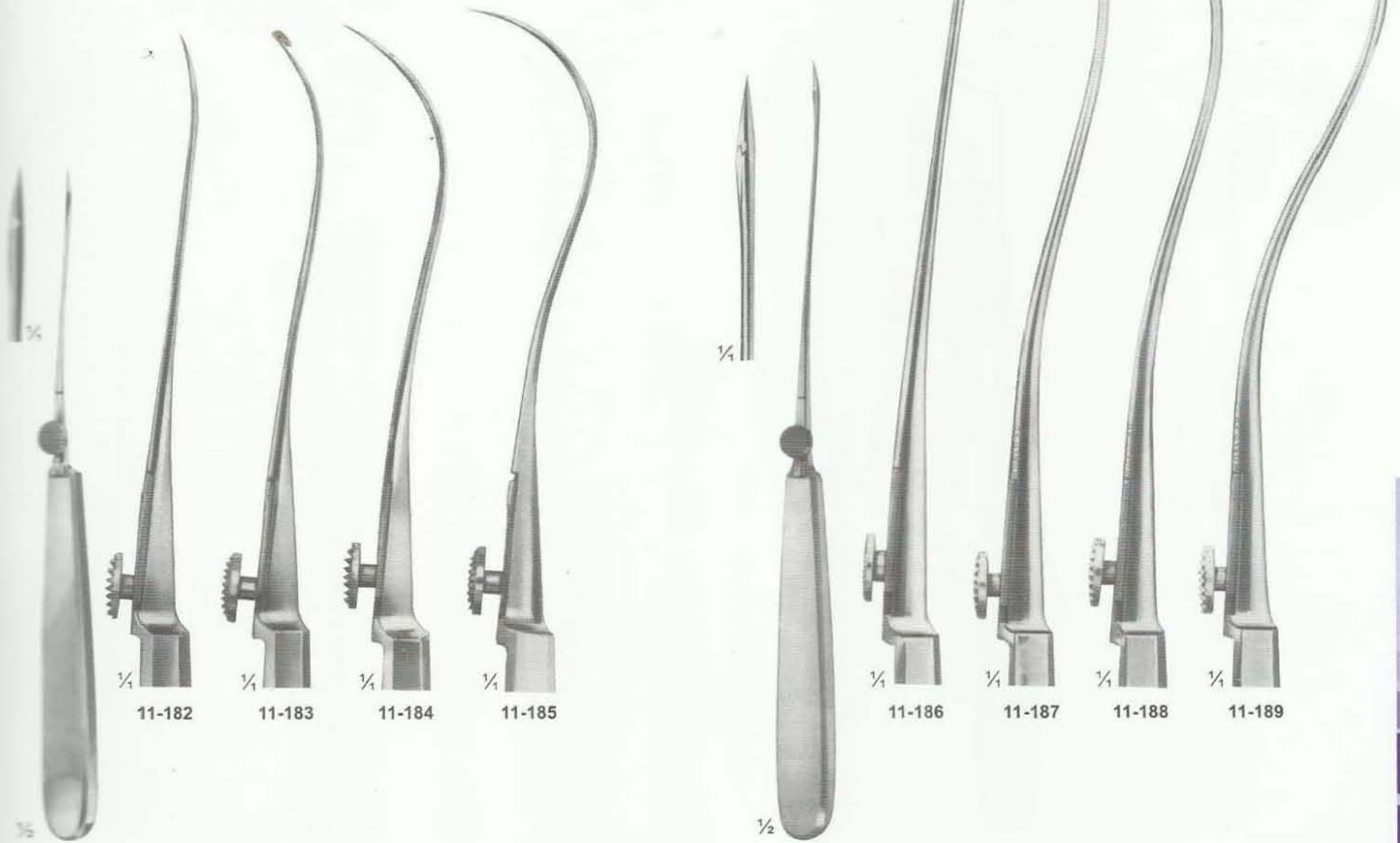

11-182

11-183

11-184

11-185

11-186

11-187

11-188

11-189

11-182 - 185
REVERDIN
195 mm

11-186 - 189
REVERDIN
220 mm

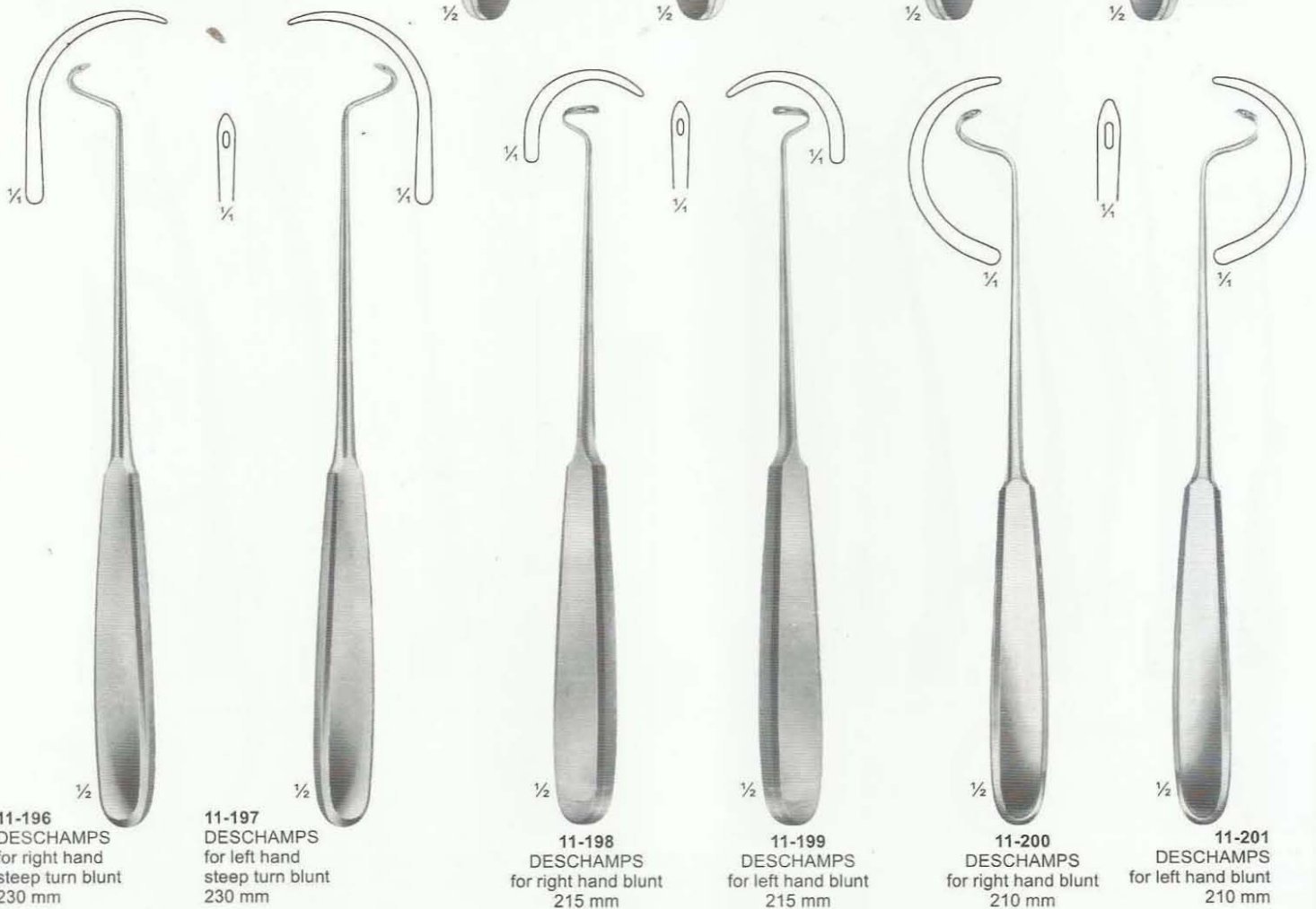



11-202
HURD
for right hand
sharp
210 mm



11-203
HURD
for left hand
sharp
210 mm



11-204
DESCHAMPS
for right hand
sharp
215 mm



11-205
DESCHAMPS
for left hand
sharp
215 mm

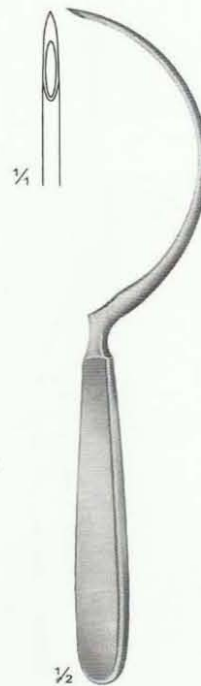

11-206
JONESCO
Needle for wire suture
185 mm



11-207
CLAUS VAN EICKEN
Needle for wire suture
250 mm

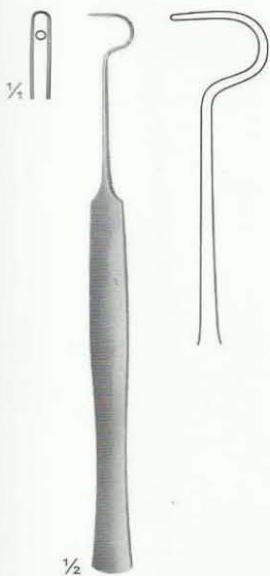

11-208
150 mm

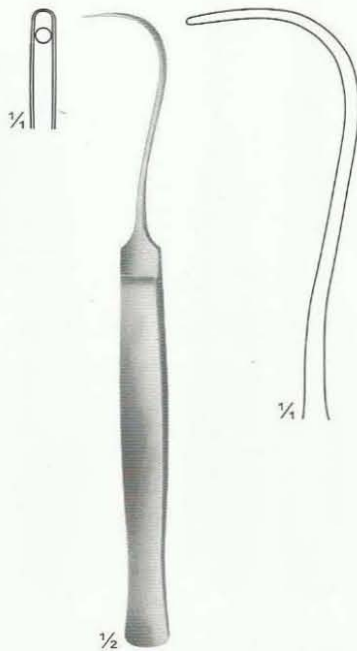

11-210
COOPER
205 mm

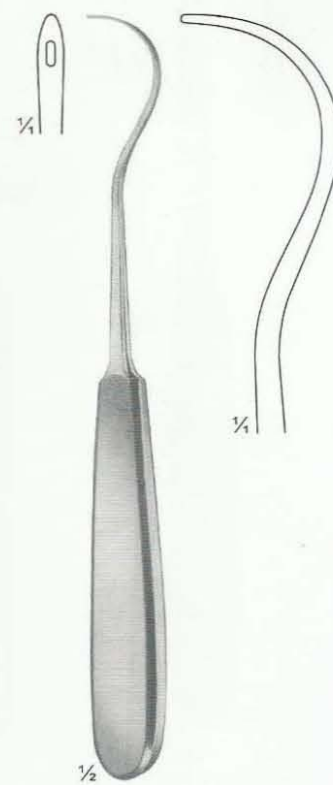

11-211
KOCHER
205 mm



11-212
BRUNNER
240 mm

11-213
SCHMIEDEN-DICK
Malleable / Flexible
320 mm

11-214 - 217
BRUNNER
Guiding Probes
300 mm

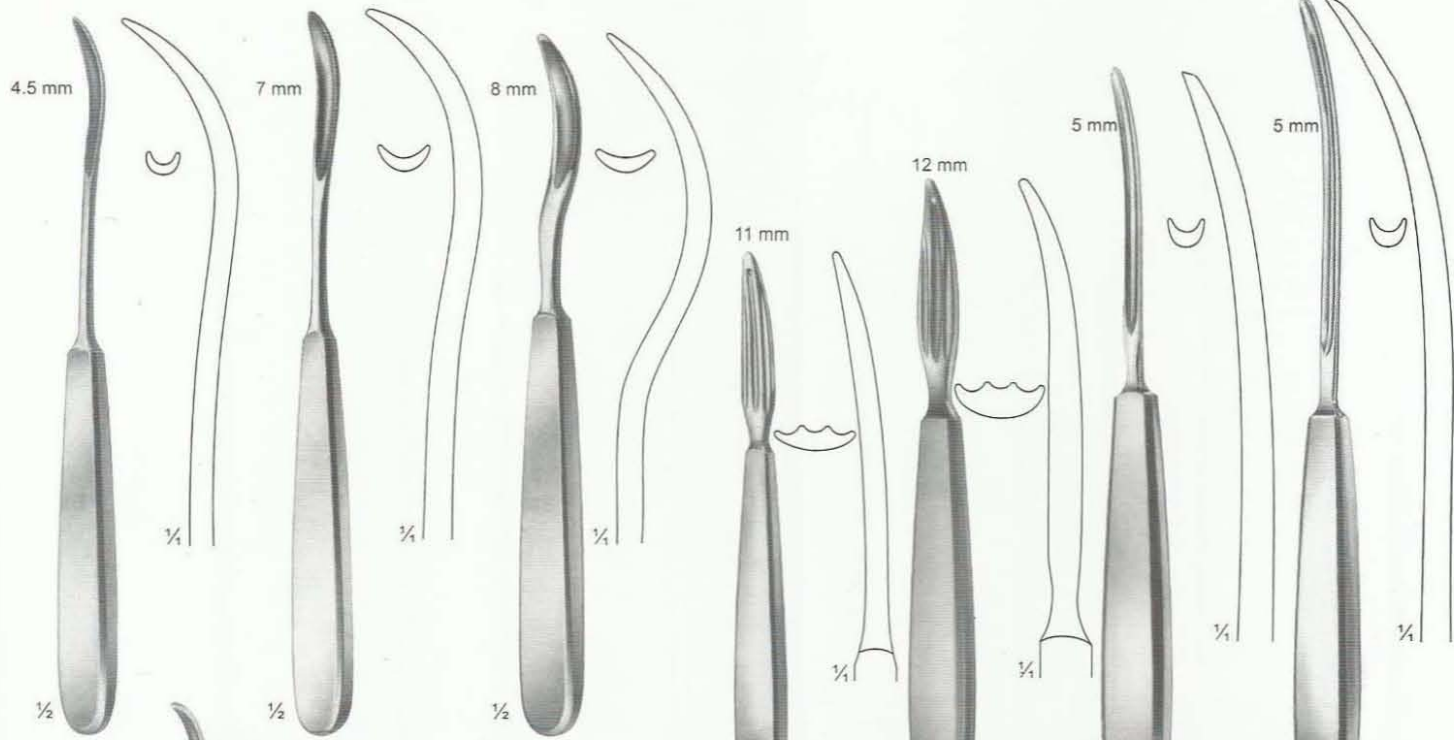

11-218
KOENIG
195 mm

11-219
KOENIG
200 mm

11-220
SCHMIEDEN
185 mm

11-221
KOCHER
150 mm

11-222
KOCHER
170 mm

11-223
PAYR
195 mm

11-224
PAYR
225 mm



11-225
280 mm

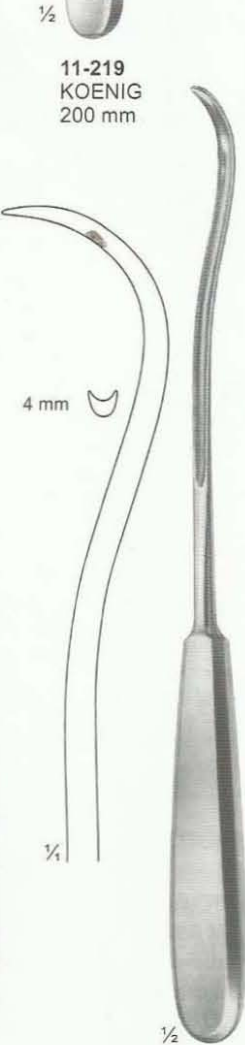

11-226
KIRSCHNER
255 mm

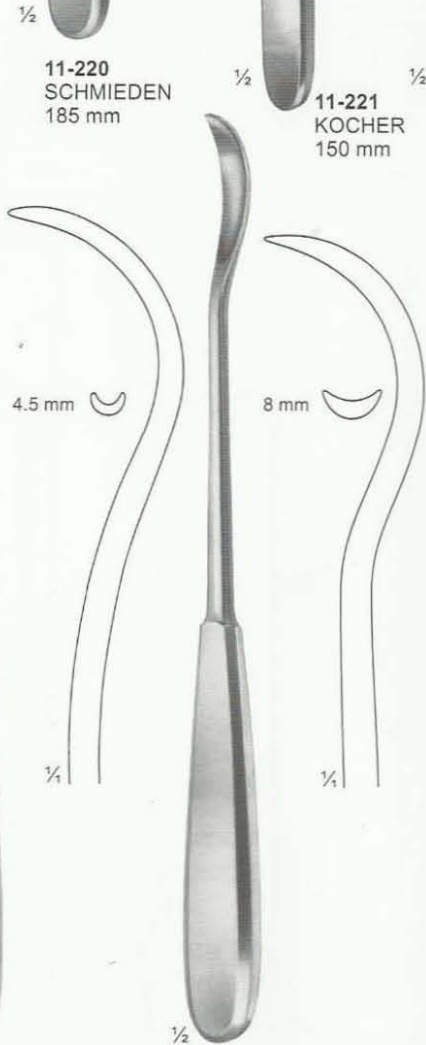

11-227
BRUNNER
245 mm



11-228
Knot tier and
ligature Adjuster.
230 mm



11-229
CASPAR
Knot tier and
ligature Adjuster
230 mm



11-230
WIENER MODELL
Suture hook
235 mm



11-231 - 233
 11-231 130 mm
 11-232 145 mm
 11-233 160 mm
 Directors



11-234
 DOYEN
 145 mm
 Directors



11-235
 NELATON
 160 mm
 Directors



11-236
 Director with tip
 Diam. Of tip 3,3 mm
 140 mm

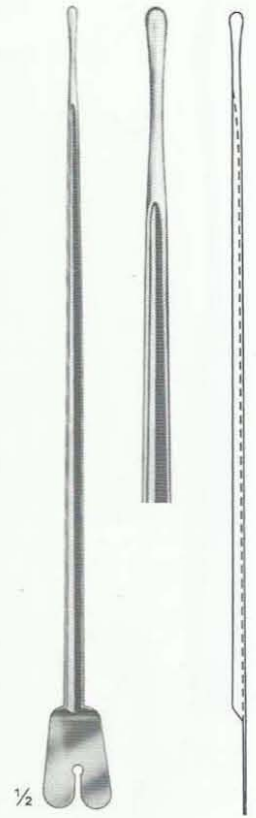

11-237
 BRODIE
 Director with tip,
 Diam. Of tip 3,5 mm
 200 mm

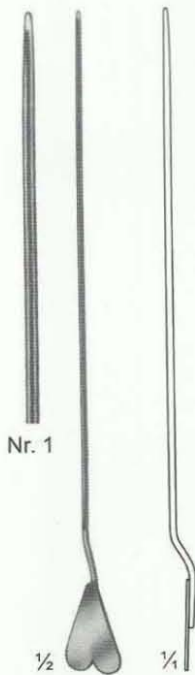

11-238
 LOCKHART-MUMMERY
 165 mm
 Straight

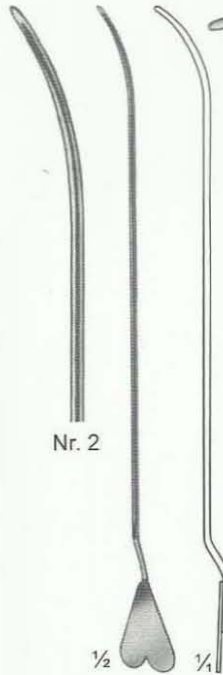

11-239
 LOCKHART-MUMMERY
 165 mm
 45° Curved

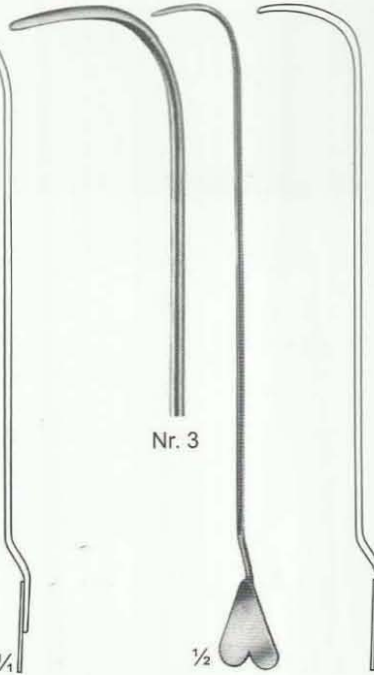

11-240
 LOCKHART-MUMMERY
 165 mm
 90° Curved

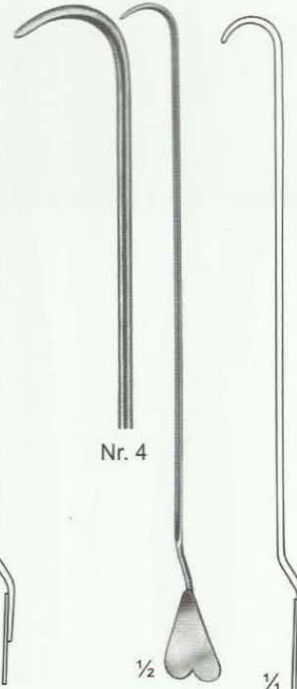

11-241
 LOCKHART-MUMMERY
 165 mm
 Retrograde Curved

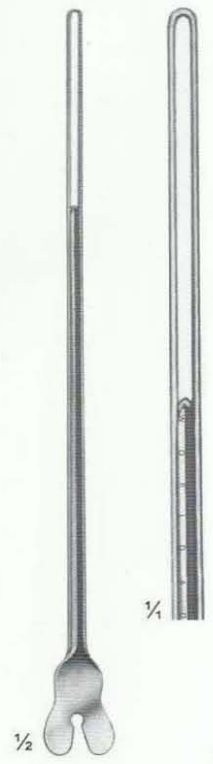

11-242
 Director with wire
 loop, malleable
 190 mm

11-243
2,5 mm Ø
11-244
2,5 mm Ø
11-245
3,0 mm Ø



1/2

11-243 - 245
11-243 145 mm
11-244 160 mm
11-245 200 mm
Probes with eye

1,5 mm Ø



1/2

11-246
Myrtle leaf probe
145 mm

2,0 mm Ø



1/2

11-247 - 251
Myrtle leaf probe
11-247 130 mm
11-248 145 mm
11-249 160 mm
11-250 180 mm
11-251 200 mm



1/2

11-252-263
Probes

diam. of tips			Length
1 mm	1,5 mm	2 mm	
-	11-253	-	130mm
11-252	11-254	11-259	145mm
-	11-255	11-260	160mm
-	11-256	11-261	180mm
-	11-257	11-262	200mm
-	11-258	-	250mm
-	-	11-263	300mm



1/2

11-264
Double ended probe,
malleable, diam. of tips
3 mm with hole
190 mm



11-265 - 266
250mm 300mm
Double ended probes,
tin, malleable,
diam. of tips
3,5 mm with hole



1/4

11-267
Double ended probe,
tin, malleable,
diam. of tips 4 mm
400 mm



1/3 Ø tip

11-268 - 270
11-268 1,5 mm
11-269 2,0 mm
11-270 2,5 mm
300 mm
Probes



11-271
STACKE
Silver
100 mm
0.8mm ϕ



11-272
KILLIAN
165 mm
0.5mm ϕ



11-273
SEIFFERT
160 mm
1.4mm ϕ



11-274
SEIFFERT
Silver
180 mm
0.5mm ϕ



11-275-279
BOWMAN
130 mm

- 11-275 0.7+0.8mm ϕ Fig. 00/0
- 11-276 0.9+1.1mm ϕ Fig. 1/2
- 11-277 1.3+1.4mm ϕ Fig. 3/4
- 11-278 1.5+1.6mm ϕ Fig. 5/6
- 11-279 1.8+1.9mm ϕ Fig. 7/8

German Silver



11-280
SPATULA
145 mm



11-281
SPATULA
145 mm



11-282
Modell PICCOLO
Round Serrated end
110 mm ϕ 0.7mm



11-283
Modell PICCOLO
Triangular Serrated end
110 mm ϕ 0.7mm



11-284
FARRELL
Round Serrated end
110 mm ϕ 1.2mm

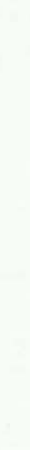

11-285
LATHBURY-FARRELL
Triangular Serrated end
110 mm ϕ 1.4mm





11-286
BUCK
Rough, spiral end
120 mm
Ø 0.9mm

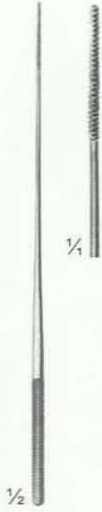

11-287
Triangular
serrated end
140 mm
Ø 0.9mm



11-288
Rough, spiral end
140 mm
Ø 1.0mm



11-289
Rough, spiral end
140 mm
Ø 1.2mm



11-290
Rough, spiral end
140 mm
Ø 1.8mm



11-291
FARRELL
Round,
serrated end
140 mm
Ø 1.2mm

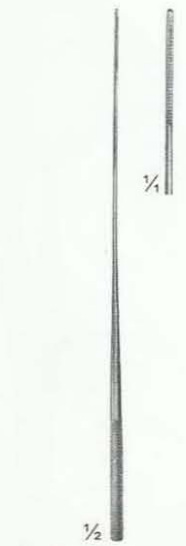

11-292
LATHBURY-FARRELL
Triangular,
serrated end
140 mm
Ø 1.4mm



11-293
FARRELL
Rough,
spiral end
160 mm
Ø 1.2mm



11-294
LATHBURY-FARRELL
Triangular,
serrated end
160 mm
Ø 1.2mm



11-295
Triangular,
serrated end
160 mm
Ø 1.4mm



11-296
Rough,
spiral end
180 mm
Ø 1.5mm



11-297
Rough,
spiral end
180 mm
Ø 1.8mm



11-298
Rough,
spiral end
270 mm
Ø 2.5mm



11-299
MICHEL
125 mm



11-300
HEGENBARTH
120 mm



11-301
WACHENFELDT
120 mm



11-302
WACHENFELDT
120 mm



11-303
MICHEL
125 mm

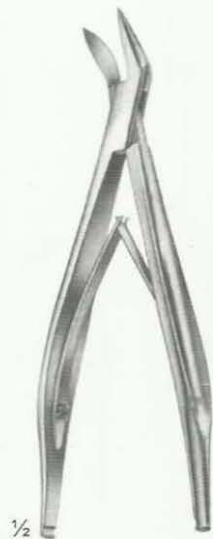

11-304
MICHEL modif.
130 mm



11-305
HEATH
135 mm

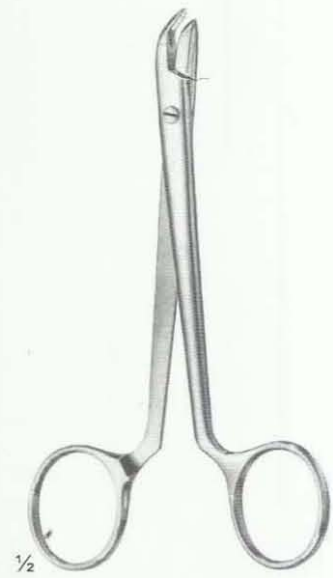

11-306
COLLIN
135 mm



11-307

Suturing instruments set, in metal case consisting of:

- 1 Michel clip applying and removing forceps,
- 1 Scissors, curved, sharp/sharp, 115mm
- 25 MICHEL clips, 16 x 3mm
- 1 Delicate tissue forceps, 130mm
- 1 Scalpel, bellied
- 1 MATHIEU needle holder, 140mm
- 1 Perforated metal case, stainless containing:
- 1 Suture needle
- 1 Suture needle
- 1 Suture needle

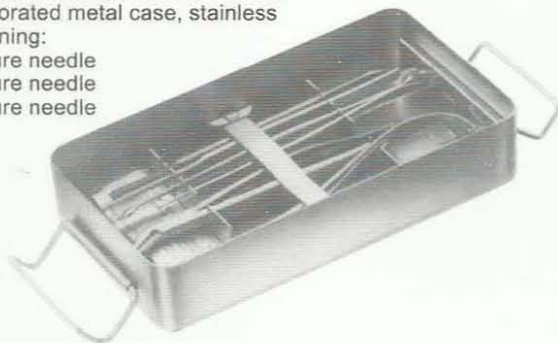

11-308

Pocket instrument set, in metal case consisting of:

Bottom tray

- 1 MATHIEU needle holder, 140mm
- 1 MICHEL clip forceps, combined
- 1 Myrtle leaf probe, 130mm
- 1 Sharp double curette
- 1 Skin hook
- 1 Detachable scalpel handle, no.4
- 1 Perforated metal case, containing
- 6 Scalpel blades
- 1 Perforated metal case, stainless, containing
- 1 Suture needle
- 1 Suture needle
- 1 Suture needle

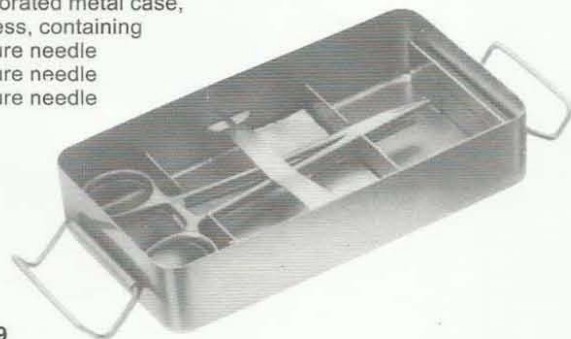

11-309

Pocket instrument set, in metal case consisting of:

Bottom tray

- 1 MAYO-HEGER needle holder, 150mm
- 1 MICHEL clip forceps, combined
- 1 Myrtle leaf probe, 130mm
- 1 Sharp double curette
- 1 Skin hook
- 1 Detachable scalpel handle, no. 4
- 1 Perforated metal case, consisting
- 6 Scalpel blades
- 1 Perforated metal case, stainless, consisting:
- 1 Suture needle
- 1 Suture needle
- 1 Suture needle



Top tray

- 1 Tissue forceps, 130mm
- 1 KOCHER haemostatic forceps, 130mm
- 1 Straight surgical scissors, 130mm
- 1 Dissecting forceps, 130mm
- 1 FEILCHENFELD splinter forceps, 115mm
- 25 MICHEL clip, 16 x 3mm
- 1 Flacon of suture skin, sterile in alcohol

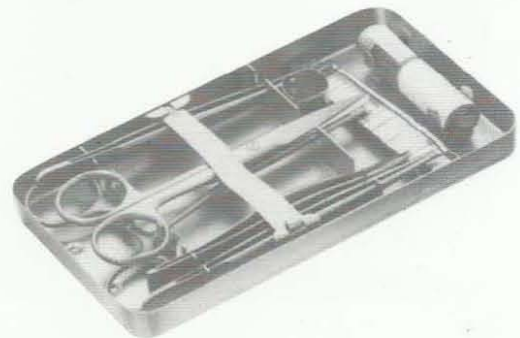

Top tray

- 1 Tissue forceps, 130mm
- 1 CRILE haemostatic forceps, 140mm
- 1 Straight surgical scissors, 130mm
- 1 Dissecting forceps, 130mm
- 1 FEILCHENFELD splinter forceps, 115mm
- 25 MICHEL clip, 16 x 3mm
- 1 Flacon of suture silk, sterile in alcohol

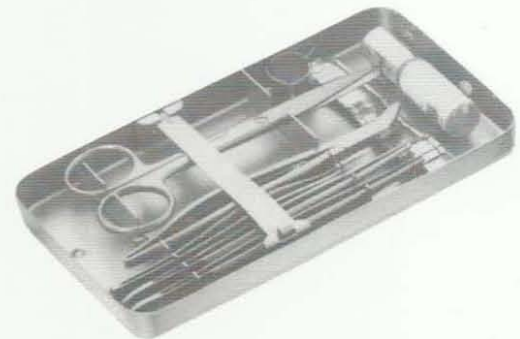

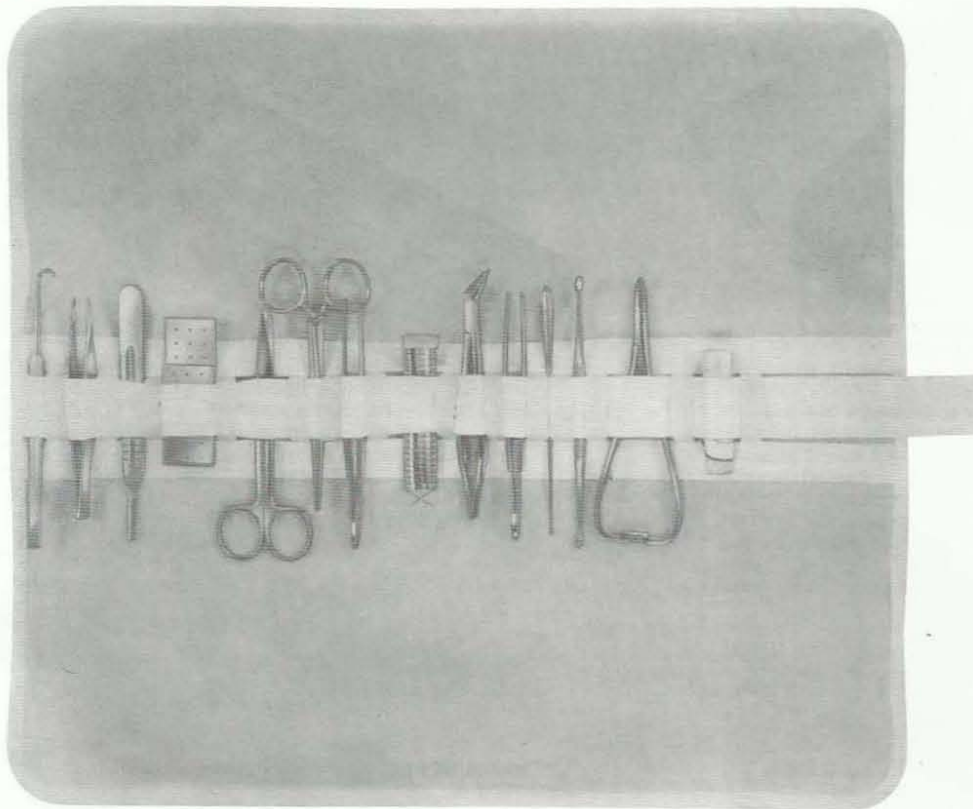

11-310
 Pocket instrument set in metal case 170 x 90mm
 canvas roll only, sterilizable in autoclave.
 consisting of:
 1 Myrtle leaf probe, 130mm
 1 Sharp double curette
 1 FEILCHENFELD splinter forceps, 115mm
 1 Dissecting forceps, 130mm
 1 Tissue forceps, 130mm

1 Straight surgical scissors, 130mm
 1 Scalpel handle no. 4
 1 Perforated metal case, consisting
 6 scalpel blades
 1 KOCHER haemostatic forceps, 130mm
 1 Skin hook
 1 MATHIEU needle holder, 140mm
 1 Tube of suture skin, sterile in alcohol
 1 MICHEL clip forceps, 120mm

25 MICHEL clip, 16 x 3mm
 1 Perforated metal case, stainless,
 consisting:
 1 Suture needle
 1 Suture needle
 1 Suture needle

11-310 A
 Canvas roll only, sterilizable in
 autoclave

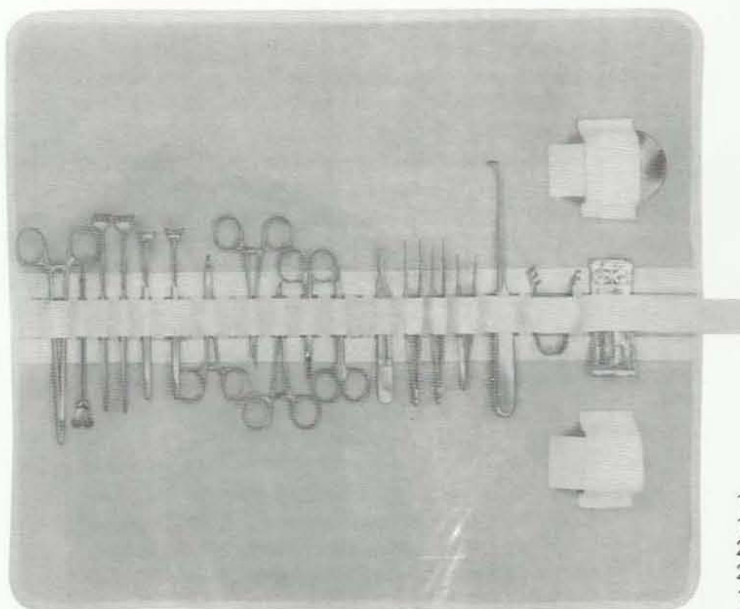

11-311
 Venae sectio set, canvas roll only, sterilizable in autoclave.
 consisting of:
 2 Tissue forceps, 1 x 2 teeth, 140mm
 1 Dissecting forceps, 145mm
 1 FEILCHENFELD splinter forceps, 115mm
 1 Straight scissors, sharp, 110mm
 1 Curved scissors, blunt, 115mm
 3 HALSTED mosquito forceps, curved on flat, 125mm

1 DESCHAMPS needle, blunt, 210mm
 1 DOYEN Director, curved, 140mm
 2 Wound retractors, 4 blunt prongs, 160mm
 2 DESMARRES wound retractors, 135mm
 1 FINSSEN retractors, 2 x3 blunt prongs, 80mm
 1 Scalpel handle no. 4
 4 Sterile scalpel blades, no 18, single peel pack
 1 Needle box, perforated, round, diam. 65mm
 1 HEGAR-MAYO DUROGRIP needle holder, 180mm

11-311 A
 Canvas roll only, sterilizable in autoclave



Suitable
 Metal Cases

250 x 125 x 55mm

233 x 148 x 57mm

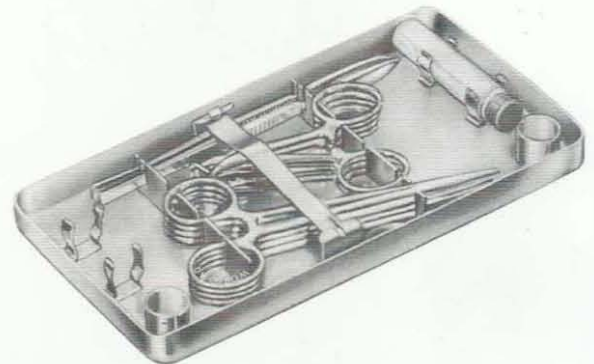
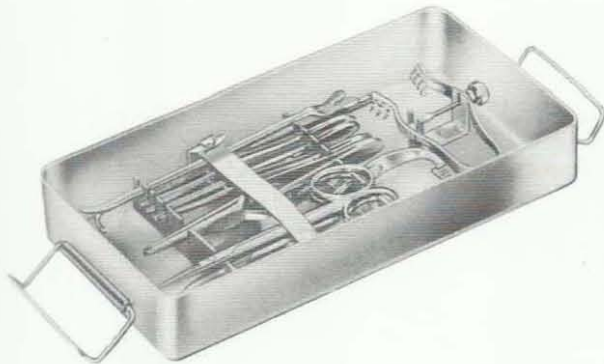

11-312

Venae sectio set, in metal case
consisting of:

Bottom tray

- 1 MATHIEU needle holder, fine pattern 140mm
- 1 Ligature needle, fine short pattern
- 1 DOYEN director, curved
- 1 HEGENBARTH clip forceps,
- 1 ELSCHNIG tissue forceps, 1 x 2 teeth fine, 105mm
- 1 Dressing forceps, fine 105mm
- 1 Tissue forceps, 1 x 2 teeth, 110mm
- 1 Vessel scissors, straight, with 1 ball point, 110mm
- 1 Vessel scissors, curved, pointed 105mm
- 1 FINSEN retractor
- 1 Perforated needle case

Top tray

- 1 Scalpel, pointed
- 1 Scalpel, bellied
- 2 HALSTED mosquito forceps, curved, 125mm
- 2 HALSTED mosquito forceps, straight, 1x 2 teeth, 125mm
- 3 BACKHAUS towel forceps, 90mm
- 2 Flacon holder

SECTION

PAGE

**Hooks
And
Retractors**

12

115-167

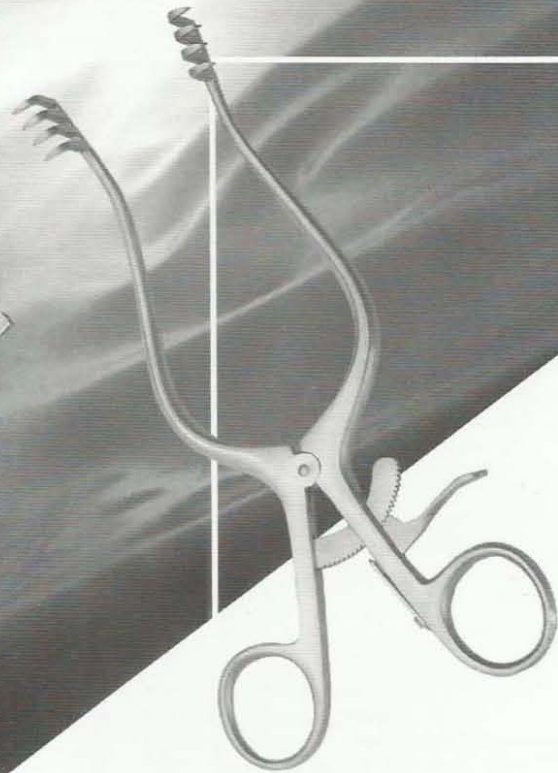

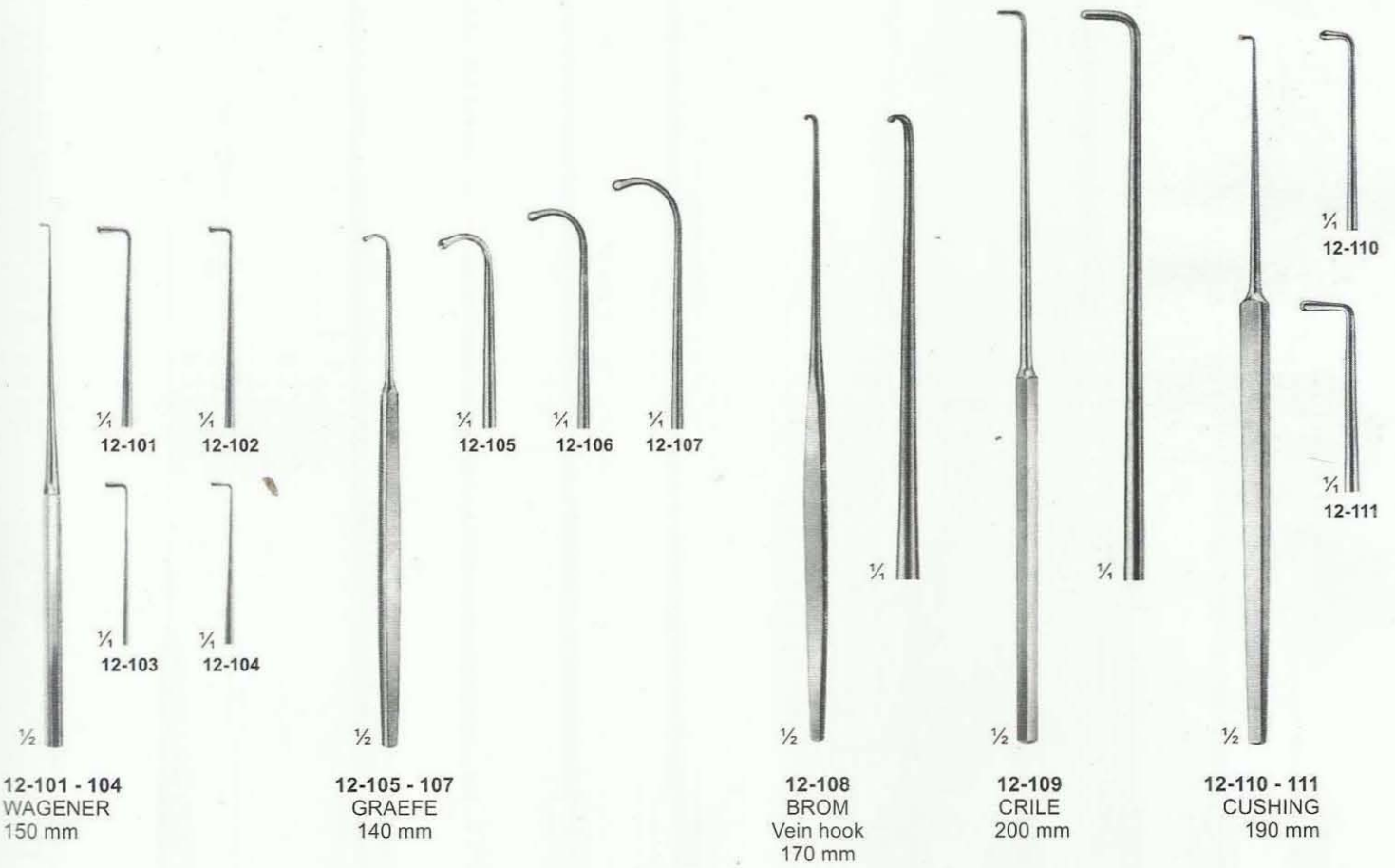

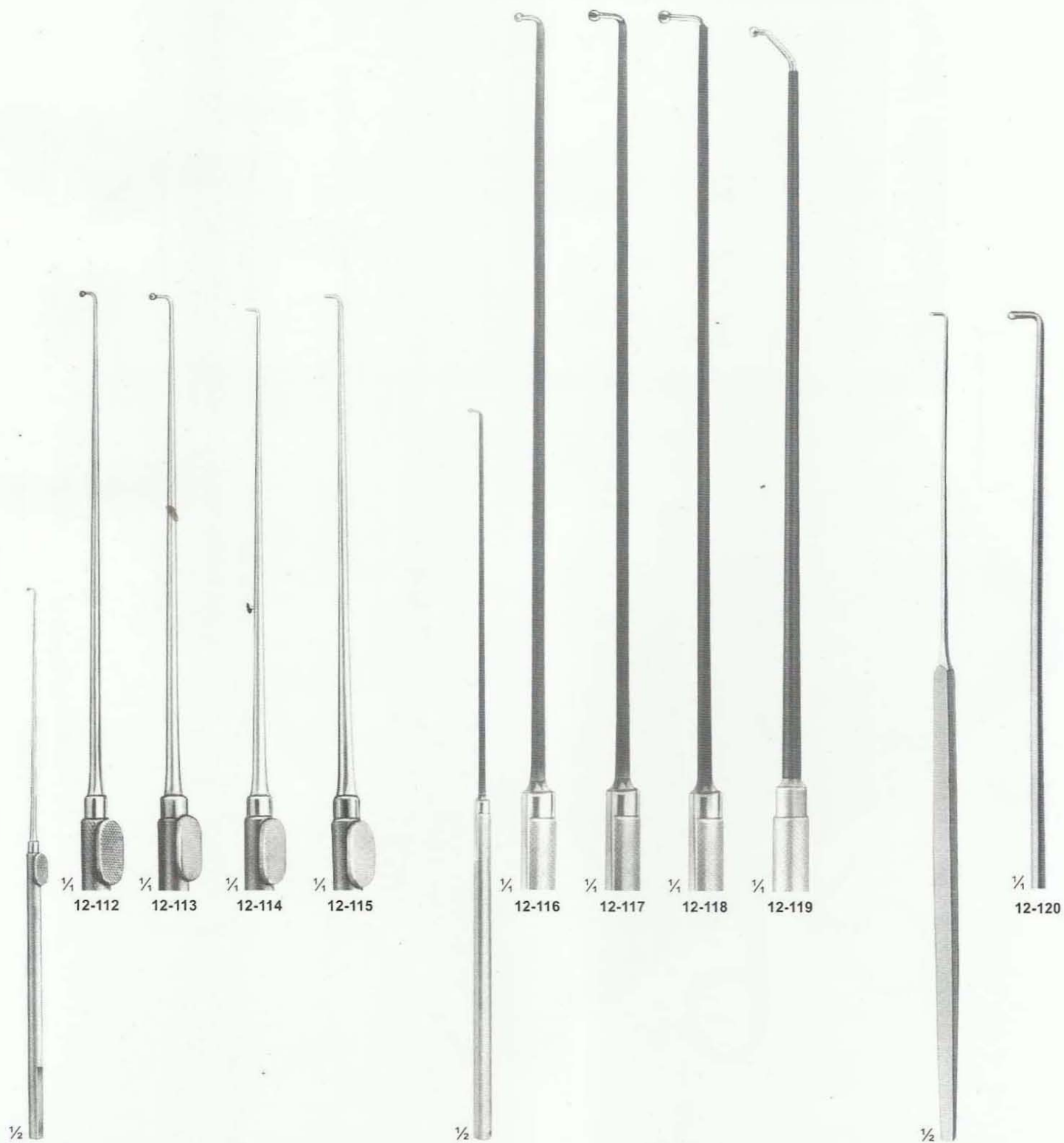

1/4 12-112 1/4 12-113 1/4 12-114 1/4 12-115

1/4 12-116 1/4 12-117 1/4 12-118 1/4 12-119

1/4 12-120

1/2
12-112 - 115
KRAYENBUHL
185 mm

1/2
12-116 - 119
CASPAR
245 mm
Exploration and coagulation
hook, probe-end, insulated.

1/2
12-120
CUSHING
280 mm

Fine Wound Retractors (Dura- and Skin Retractors)

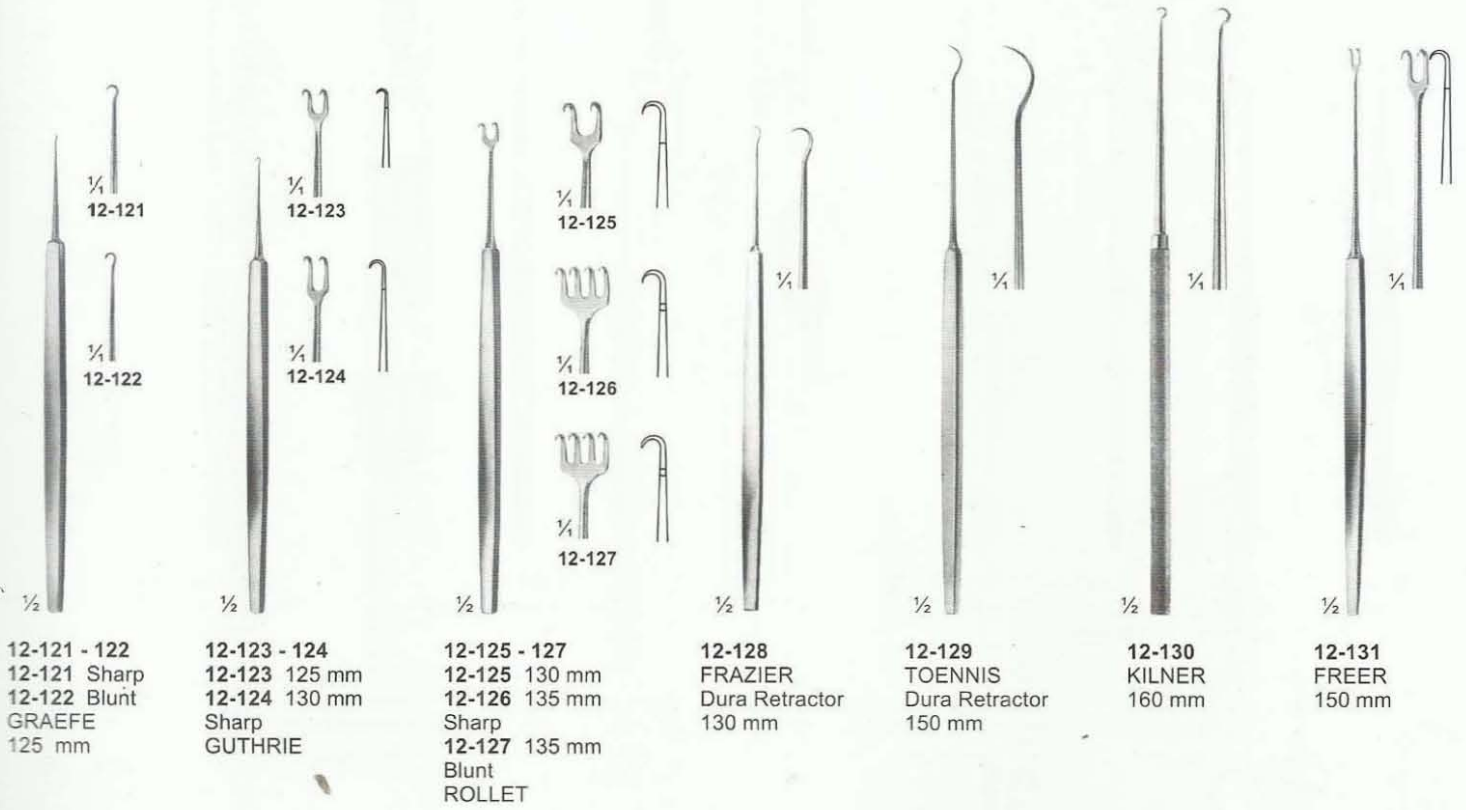

12-121 - 122
12-121 Sharp
12-122 Blunt
GRAEFE
125 mm

12-123 - 124
12-123 125 mm
12-124 130 mm
Sharp
GUTHRIE

12-125 - 127
12-125 130 mm
12-126 135 mm
Sharp
12-127 135 mm
Blunt
ROLLET

12-128
FRAZIER
Dura Retractor
130 mm

12-129
TOENNIS
Dura Retractor
150 mm

12-130
KILNER
160 mm

12-131
FREER
150 mm

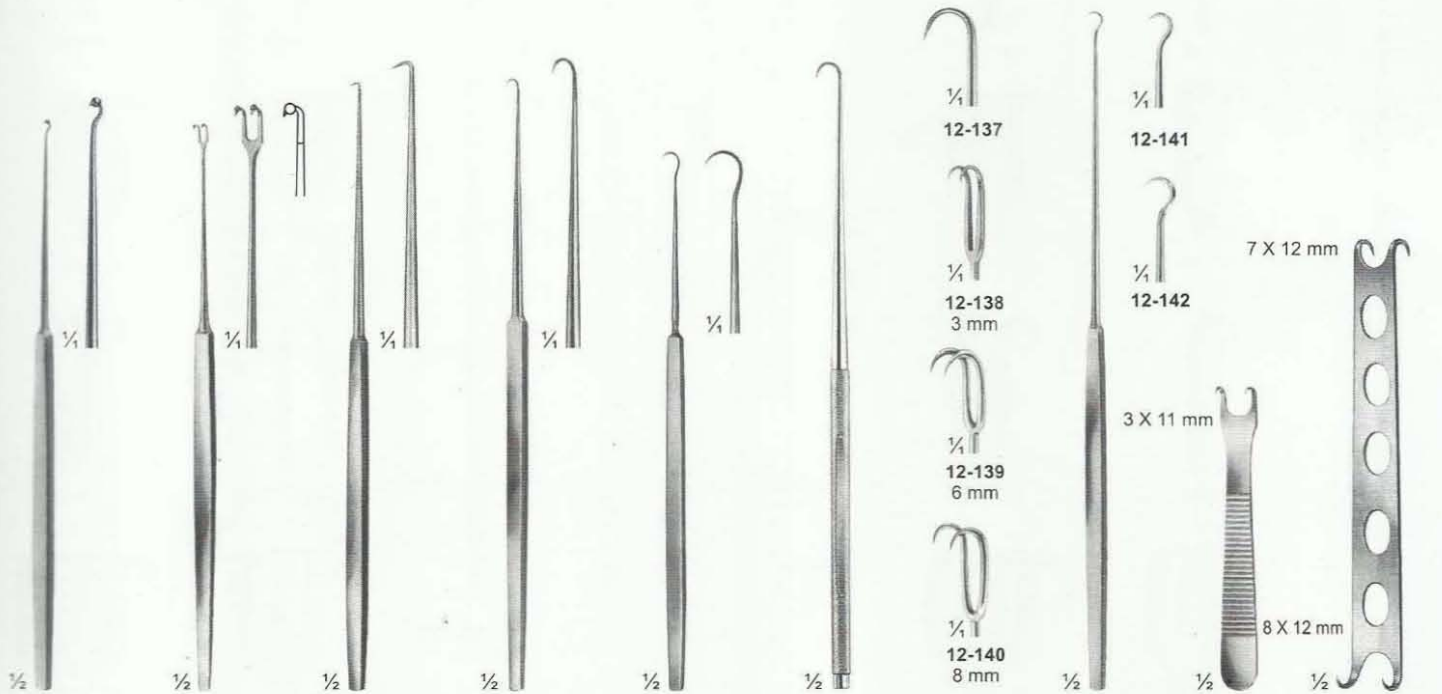

12-132
MULLER
150 mm

12-133
MULLER
150 mm

12-134
COTTLE
160 mm

12-135
COTTLE
160 mm

12-136
JAEGER
135 mm

12-137 - 140
JOSEPH
165 mm

12-141 - 142
GILLIES
180 mm

12-143
KILNER
Sharp
80 mm

12-144
CONVERSE
Blunt
120 mm

Wound - Trachea Retractors

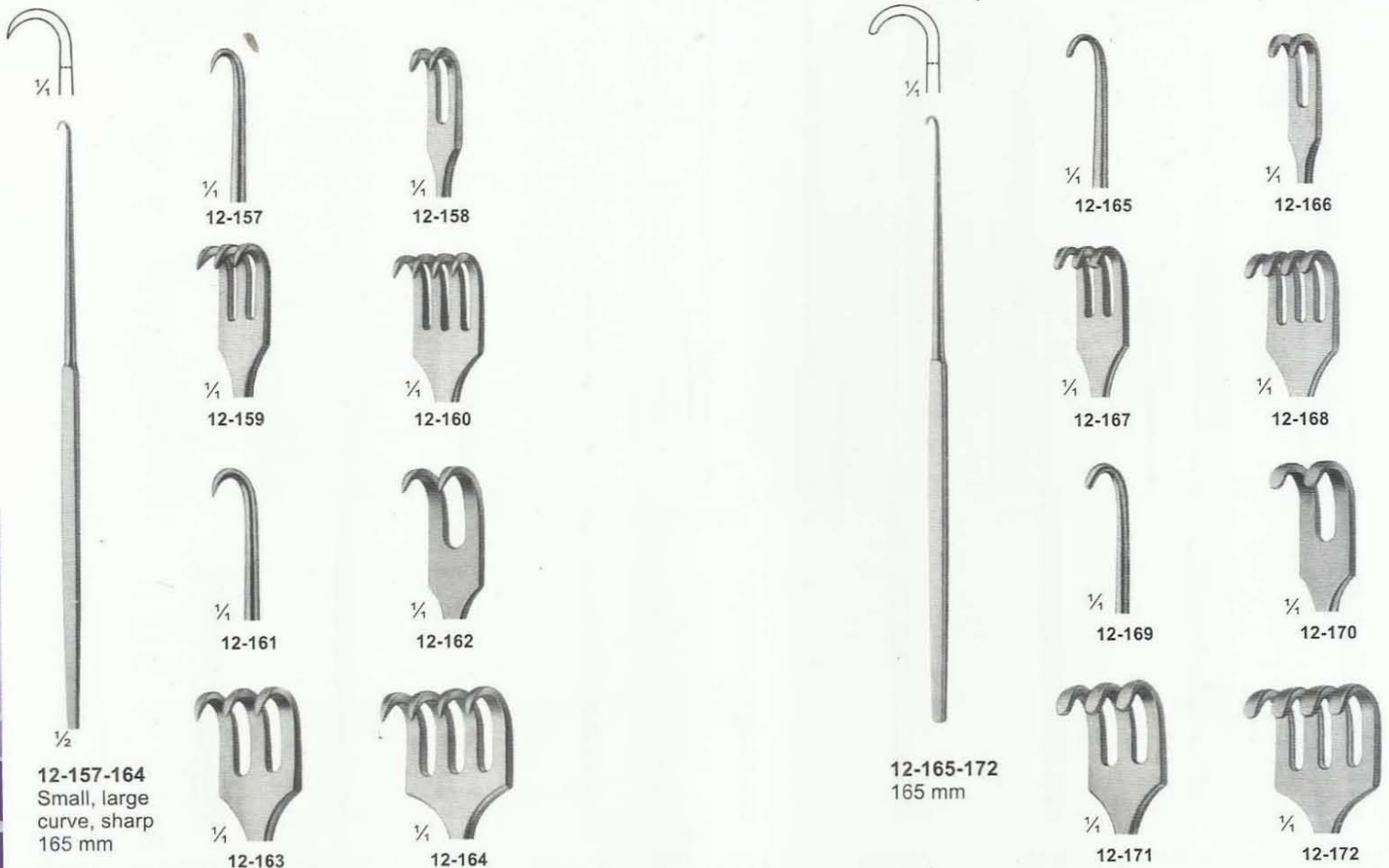

12-157-160 (small, curved, sharp)
12-161-164 (large, curved, sharp)

12-165-168 (small, curved, blunt)
12-169-172 (large, curved, blunt)

Retractors With Treangle Handle

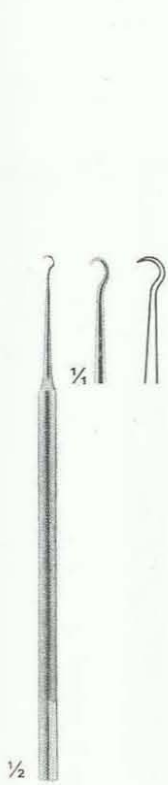

12-173
MANNERFELT modif.
sharp
135 mm



12-174
MANNERFELT modif.
sharp
155 mm



12-175
MANNERFELT modif.
sharp
155 mm



12-176 - 178
MANNERFELT modif.
Small curve, sharp
155 mm

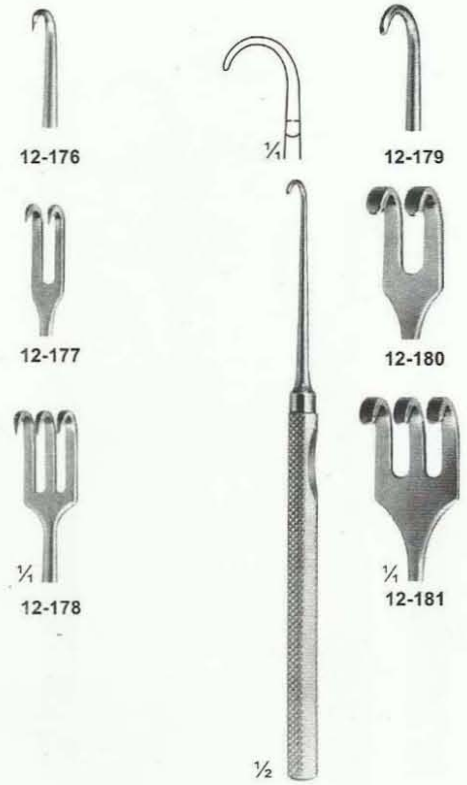

12-179 - 181
MANNERFELT modif.
Large curve, blunt
155 mm



12-182 - 185
LANGENBECK-
MANNERFELT modif.
155 mm

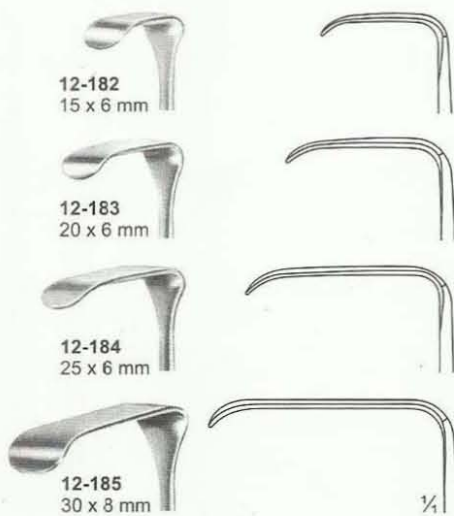

12-186 - 188
MANNERFELT modif.
Saddle hooks,
155 mm

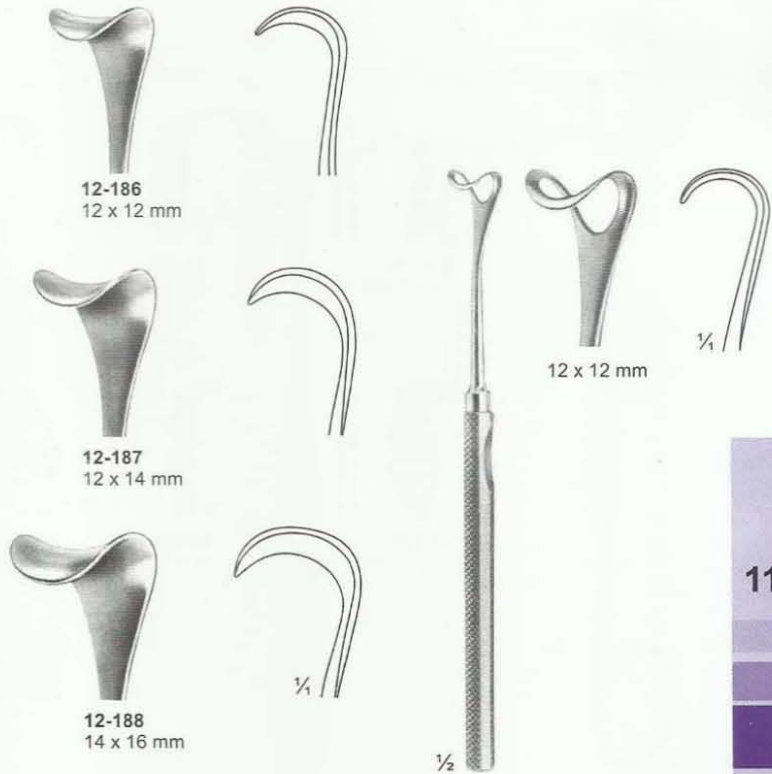

12-189
MANNERFELT modif.
Saddle hooks, fenestrated
155 mm

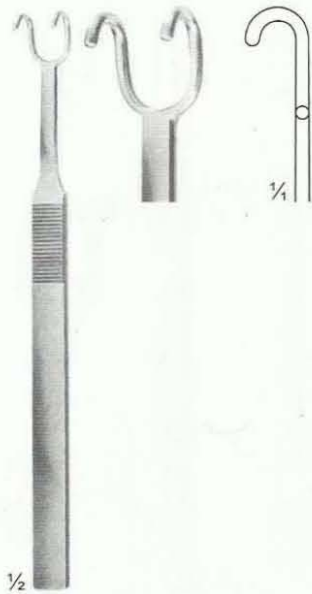

12-190
FOMON
145 mm

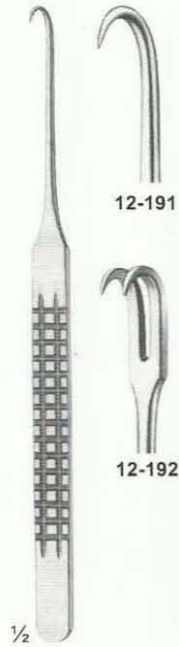

12-191 - 192
160 mm



12-193 - 194
LANGENBECK-GREEN
160 mm

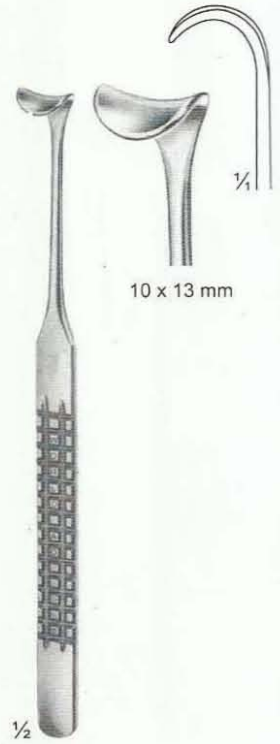

12-195
160 mm

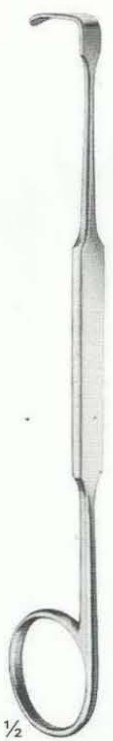

12-196 - 201
MEYERDING
Fig. A - Fig. F
180 mm

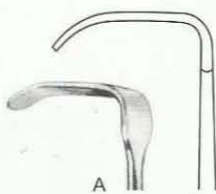

A
12-196
18 x 7 mm

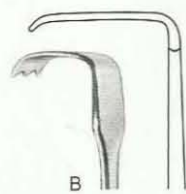

B
12-197
16 x 5 mm



C
12-198
7 x 4 mm



D
12-199
5 x 10 mm



E
12-200
11 x 4 mm



F
12-201
6 x 4 mm

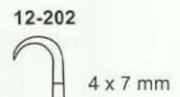

12-202
4 x 7 mm



12-203

12-204



12-202 - 204
WILLIGER
120 mm



12-205
EMMET
Fistula hook
220 mm



12-206
SIMON
Fistula hook
220 mm

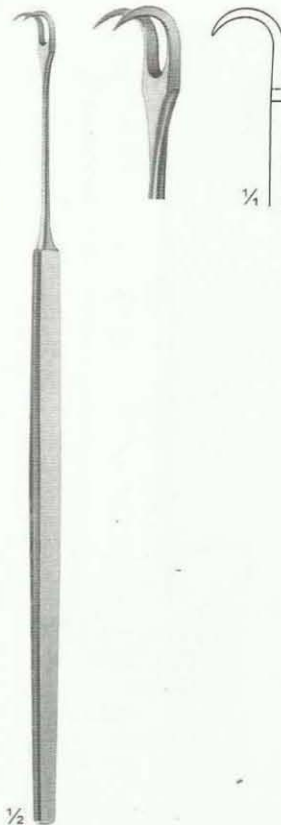

12-207
SIMON
Fistula hook
220 mm



12-208
LANGE
Fistula hook
230 mm

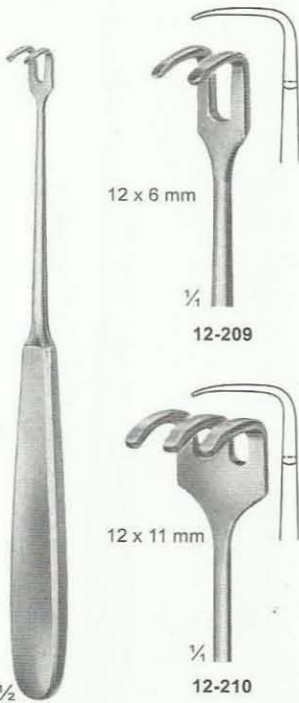

12-209 - 210
Tendon hooks
175 mm

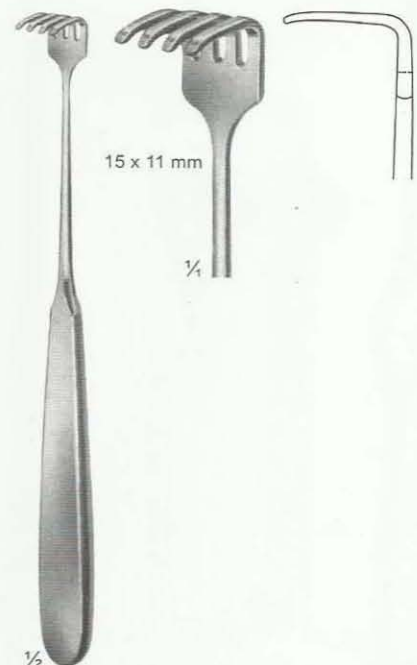

12-211
KLAPP
Tendon hooks
175 mm

Wound and Vein Retractors



12-212
MASING
140 mm



12-213
COTTLE
140 mm



12-214 - 218
DESMARRES
140 mm



12-214
9 x 9 mm



12-215
9 x 12 mm



12-216
11 x 14 mm



12-217
12 x 16 mm



12-218
13 x 18 mm



12-219 - 220
KOENIG
180 mm



12-219
13 x 13 mm



12-220
12 x 16 mm



12-221
CUSHING-KOCHER
175 mm



10 x 10 mm



12-222 - 223
KOCHER
205 mm

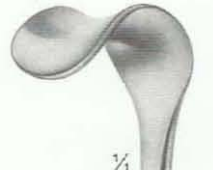

12-222
20 x 12 mm

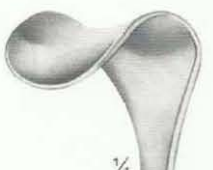

12-223
20 x 15 mm



12-224
SCHOENBORN
200 mm



13 x 6 mm



12-225 - 226
CUSHING
205 mm



12-225
10 x 13 mm



12-226
14 x 18 mm



12-227
205 mm

20 x 15 mm

20 x 19 mm



12-228 - 230
CUSHING
250 mm



12-228
11 x 14 mm



12-229
13 x 18 mm



12-230
15 x 22 mm

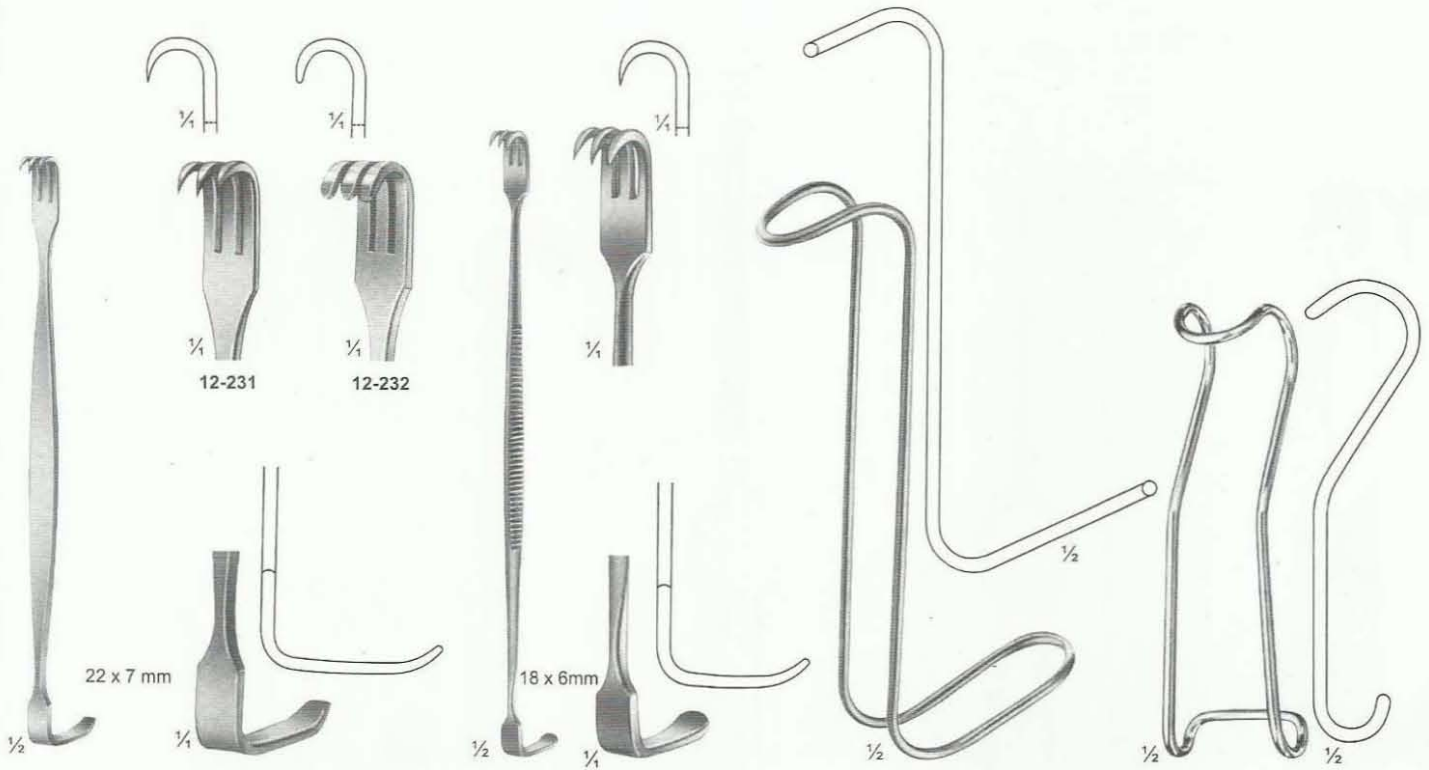

12-231 - 232
BABY-SENN-MILLER
155 mm

12-233
SENN-MILLER
165 mm

12-234
COLLIN-HARTMANN
150 mm

12-235 - 237
STERNBERG
12-235 120 mm
12-236 130 mm
12-237 135 mm

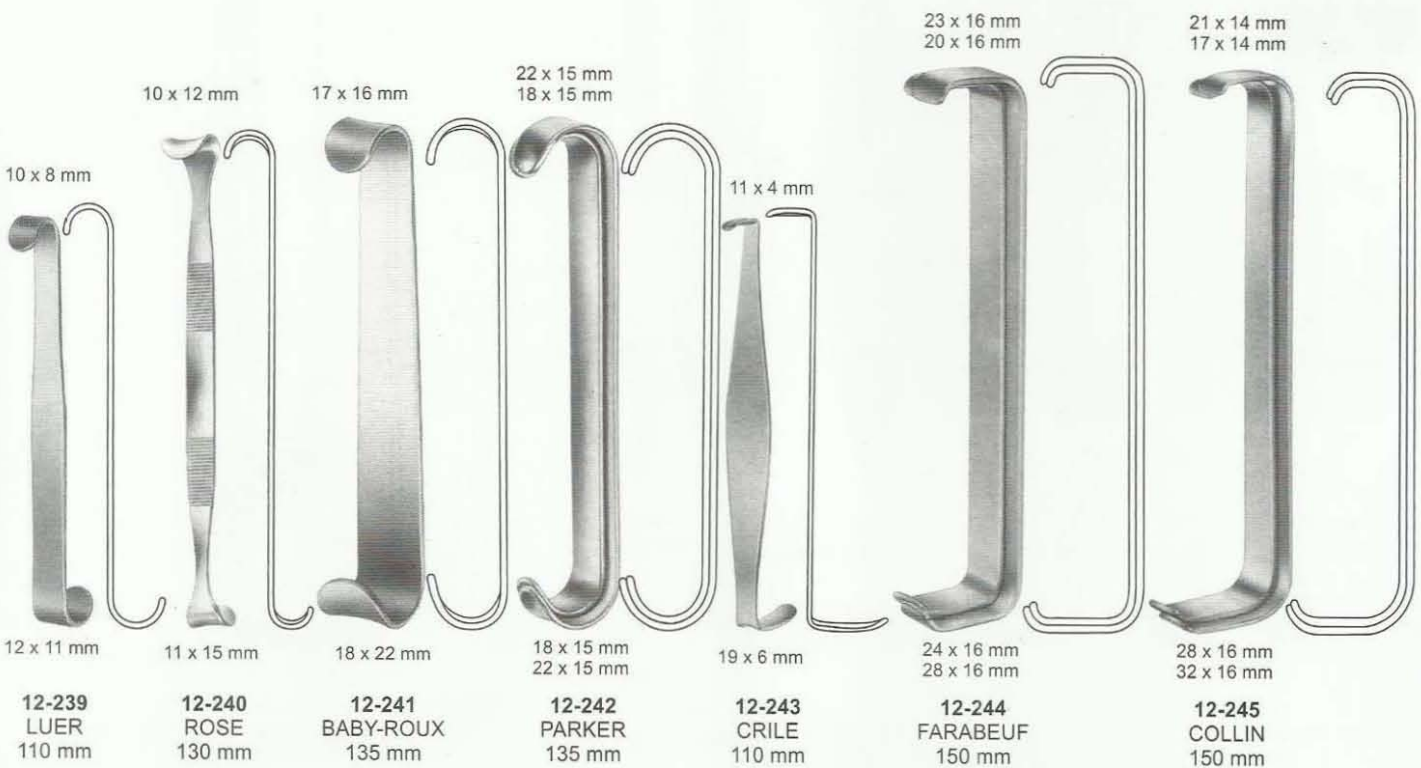

12-239
LUER
110 mm

12-240
ROSE
130 mm

12-241
BABY-ROUX
135 mm

12-242
PARKER
135 mm

12-243
CRILE
110 mm

12-244
FARABEUF
150 mm

12-245
COLLIN
150 mm

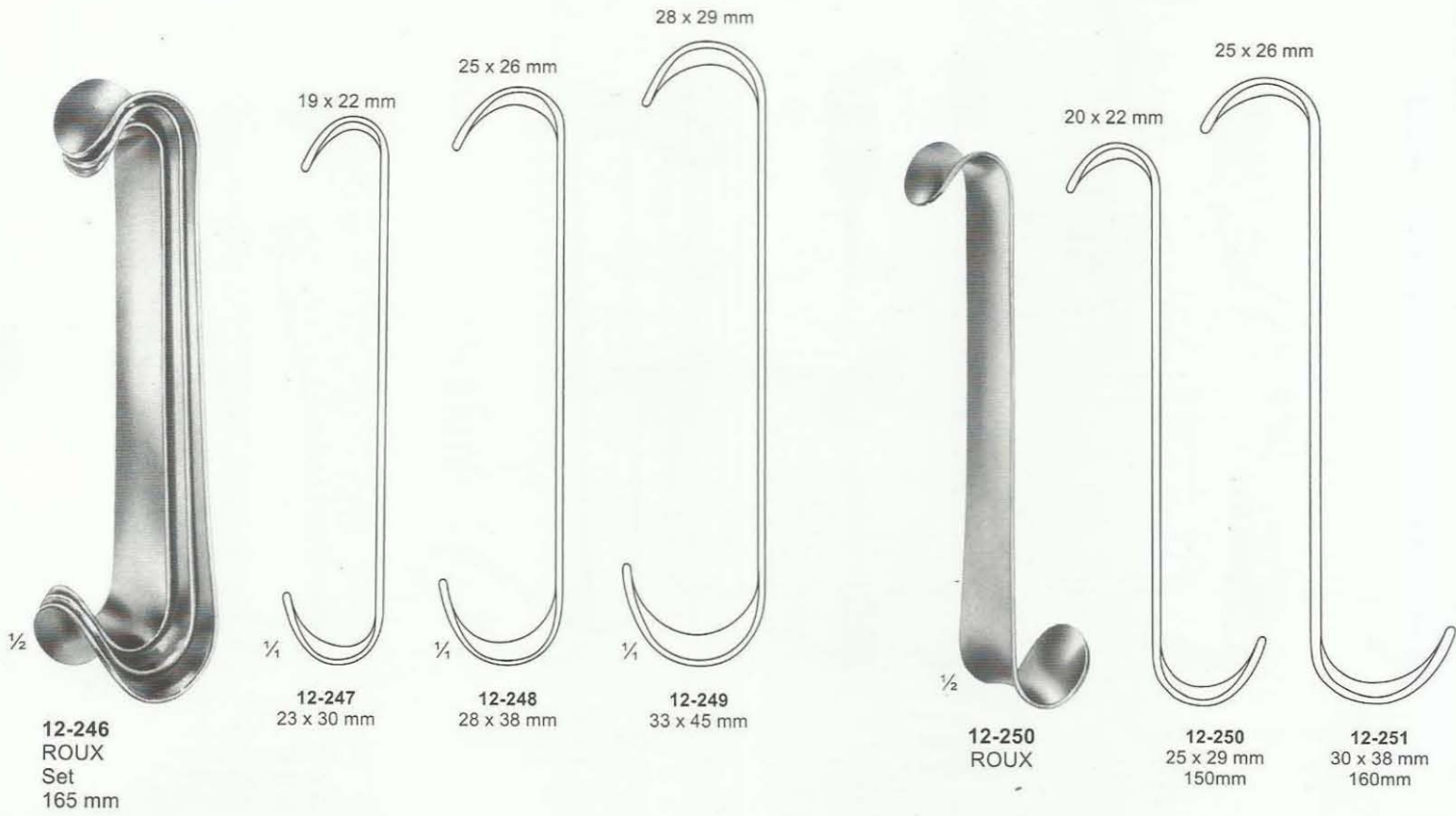



12-255
KOCHER
Sharp
205 mm



12-256
KOCHER
Sharp
220 mm



12-257
VOLKMANN
Sharp
220 mm



12-258
VOLKMANN
Blunt
220 mm



12-259
VOLKMANN
Sharp
220 mm



12-260 - 267
VOLKMANN
225 mm

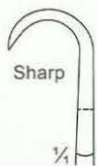

Sharp



12-260
9 x 8 mm



12-261
9 x 13 mm



12-262
9 x 19 mm



12-263
9 x 29 mm

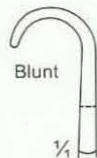

Blunt



12-264
8,5 x 8 mm



12-265
8,5 x 13 mm



12-266
8,5 x 19 mm



12-267
8,5 x 29 mm

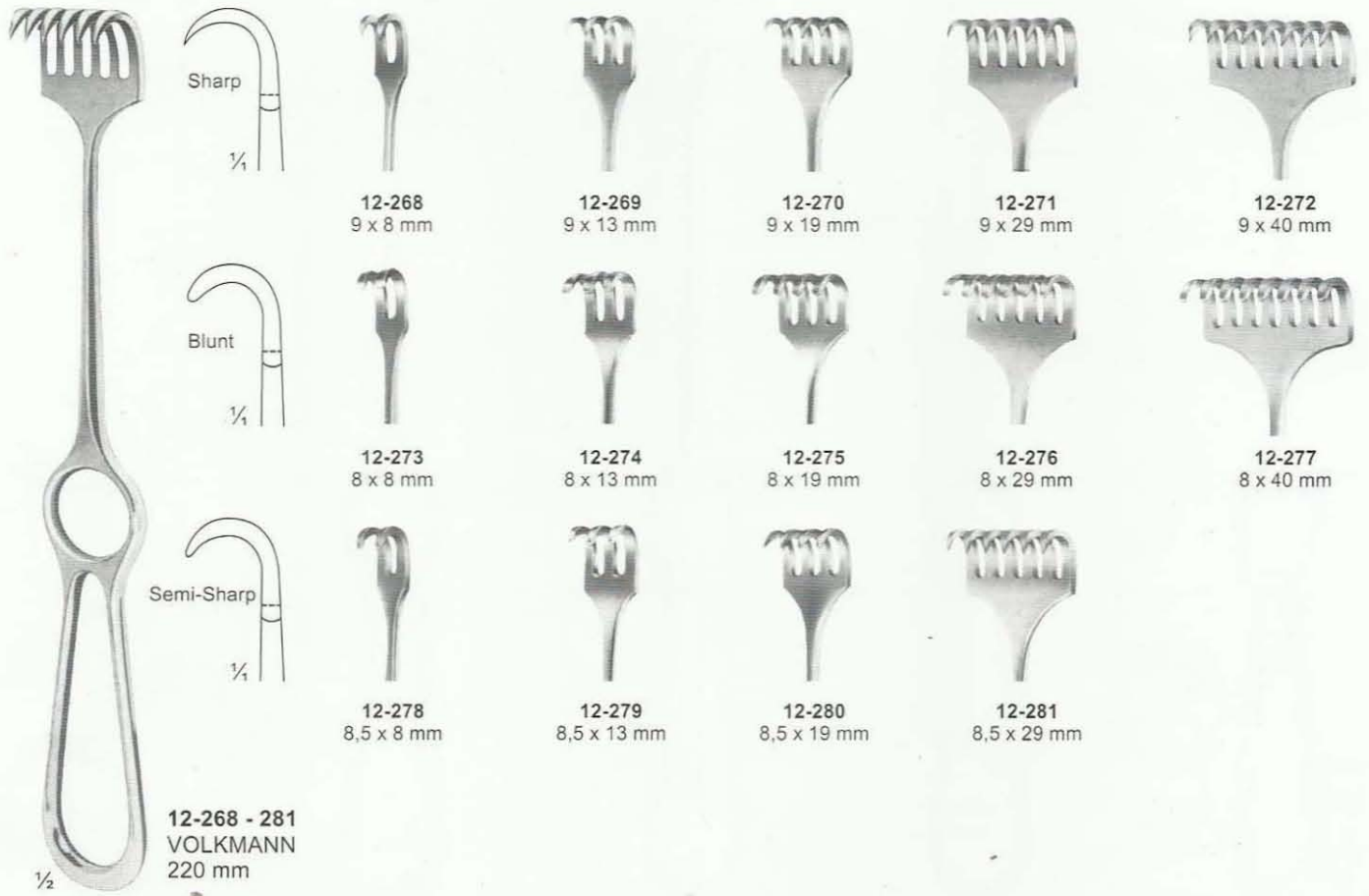

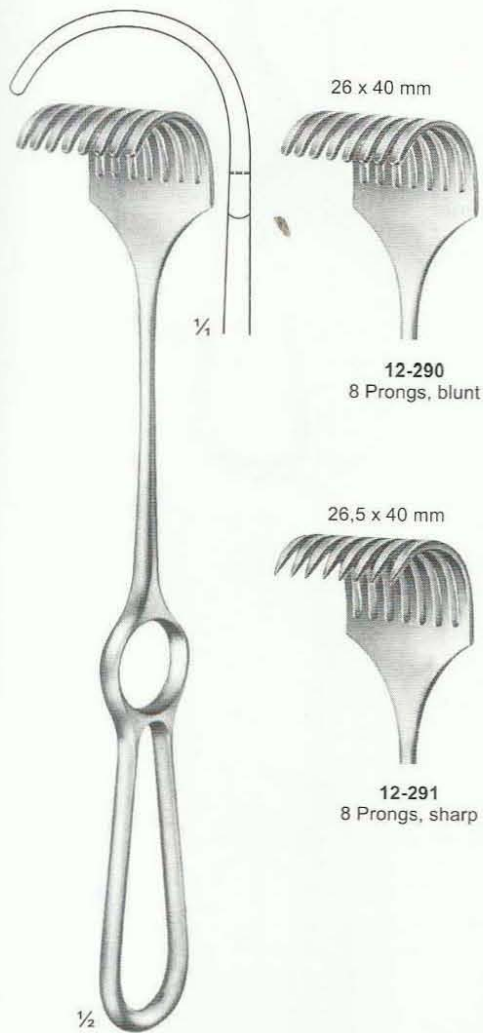

26 x 40 mm

12-290
8 Prongs, blunt

26,5 x 40 mm

12-291
8 Prongs, sharp

1/2

12-290 - 291
KOERTE
Handle vertical
to the blade.
240 mm



39 x 40 mm

12-292
4 Prongs, blunt

1/2

12-292 - 295
ISRAEL
255 mm

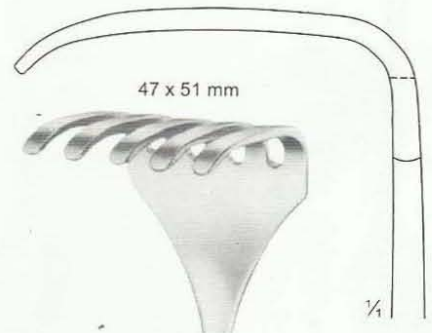

47 x 51 mm

12-293
5 Prongs, blunt

1/4

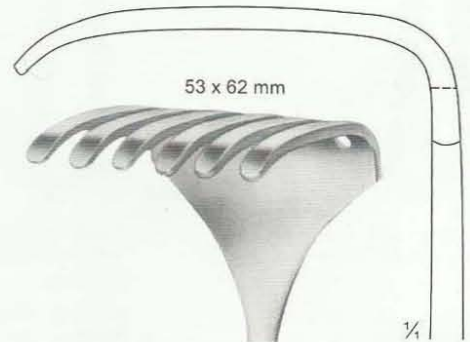

53 x 62 mm

12-294
6 Prongs, blunt

1/4

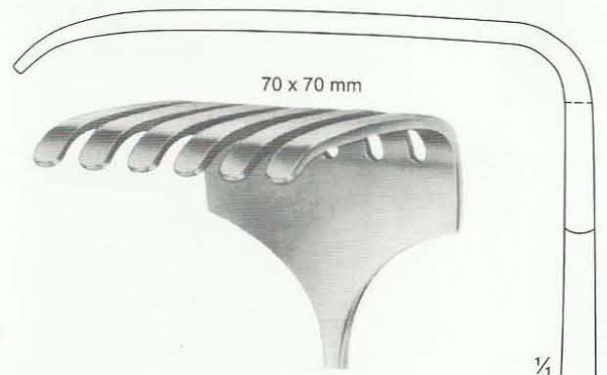

70 x 70 mm

12-295
6 Prongs, blunt

1/4



1/2
12-296 - 301
LANGENBECK
 210 mm

- 12-296 28 x 10 mm
- 12-297 28 x 14 mm
- 12-298 33 x 14 mm
- 12-299 28 x 16 mm
- 12-300 40 x 10 mm
- 12-301 40 x 13 mm



1/2
12-302 - 310
KOCHER-LANGENBECK
 215 mm

- 12-302 25 x 6 mm
- 12-303 35 x 8 mm
- 12-304 35 x 11 mm
- 12-305 35 x 15 mm
- 12-306 41 x 11 mm
- 12-307 55 x 11 mm
- 12-308 70 x 14 mm
- 12-309 80 x 12 mm
- 12-310 80 x 16 mm

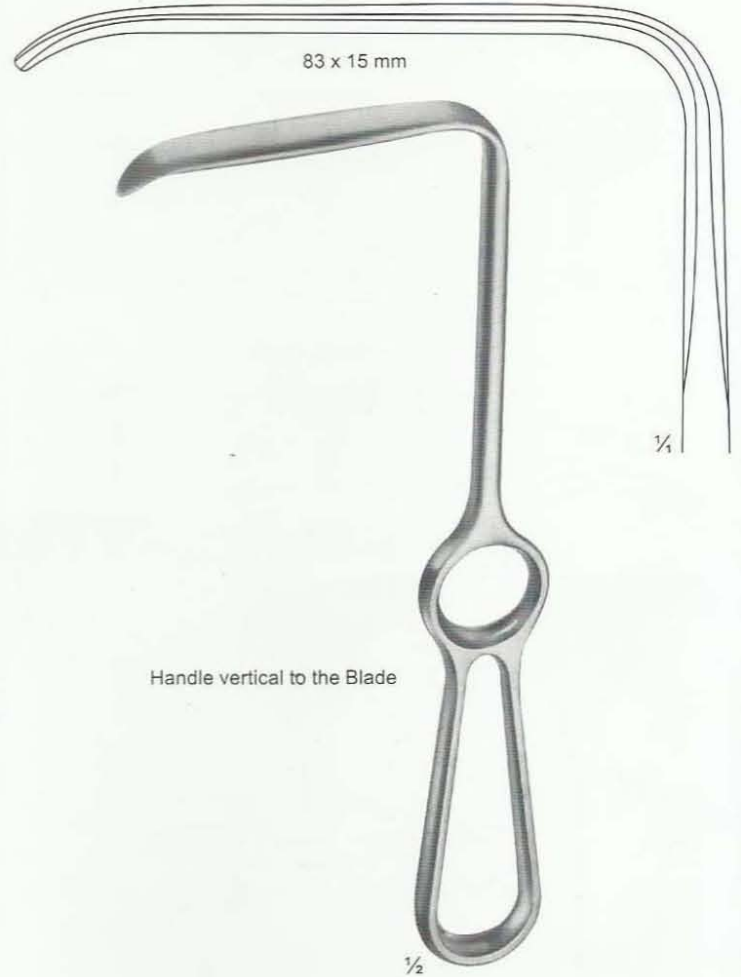

1/2
12-311
LANGENBECK
 215 mm

Handle vertical to the Blade



12-312 - 316
KOCHER
230 mm

1/2



12-317 - 319
SAUERBRUCH
225 mm

1/2

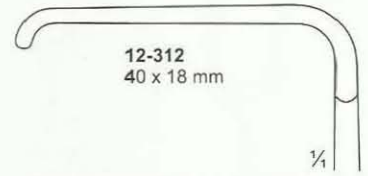

12-312
40 x 18 mm

1/4

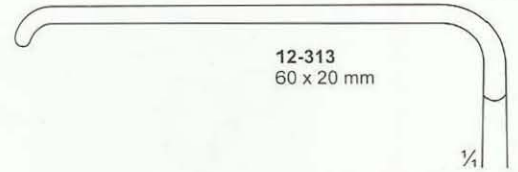

12-313
60 x 20 mm

1/4

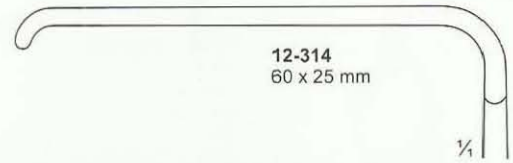

12-314
60 x 25 mm

1/4

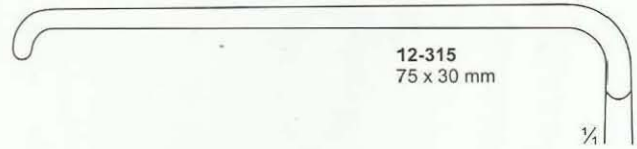

12-315
75 x 30 mm

1/4

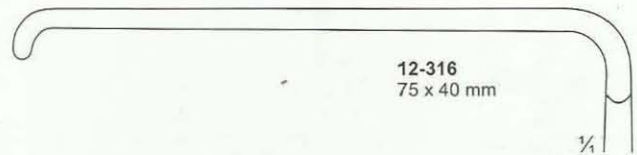

12-316
75 x 40 mm

1/4

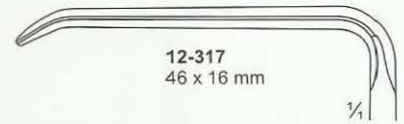

12-317
46 x 16 mm

1/4

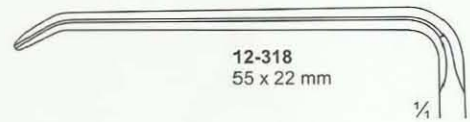

12-318
55 x 22 mm

1/4

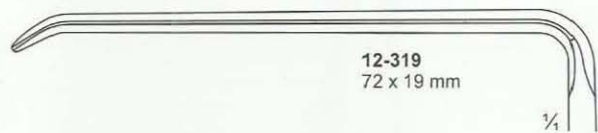

12-319
72 x 19 mm

1/4

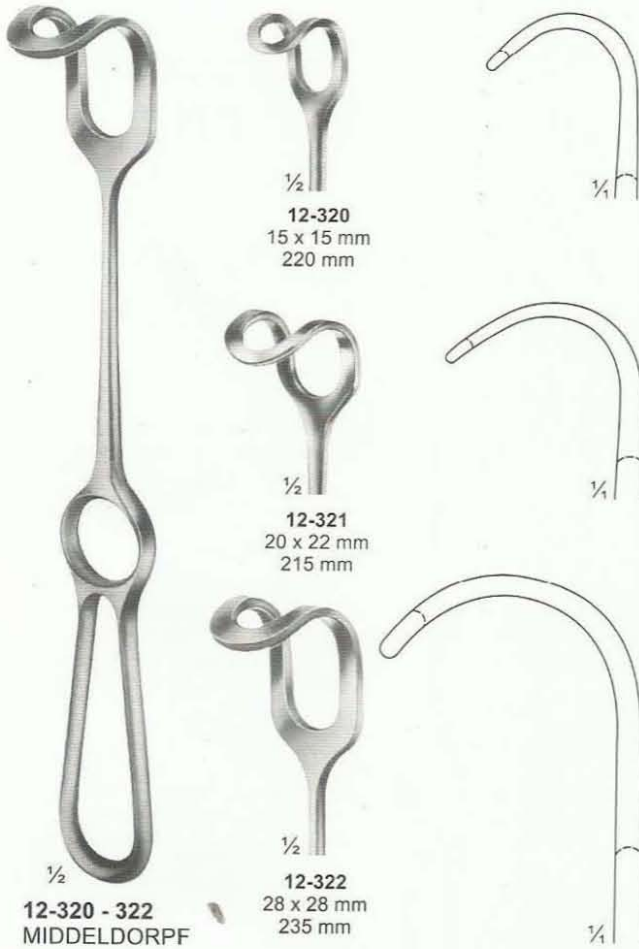

12-320 - 322
MIDDELDORPF

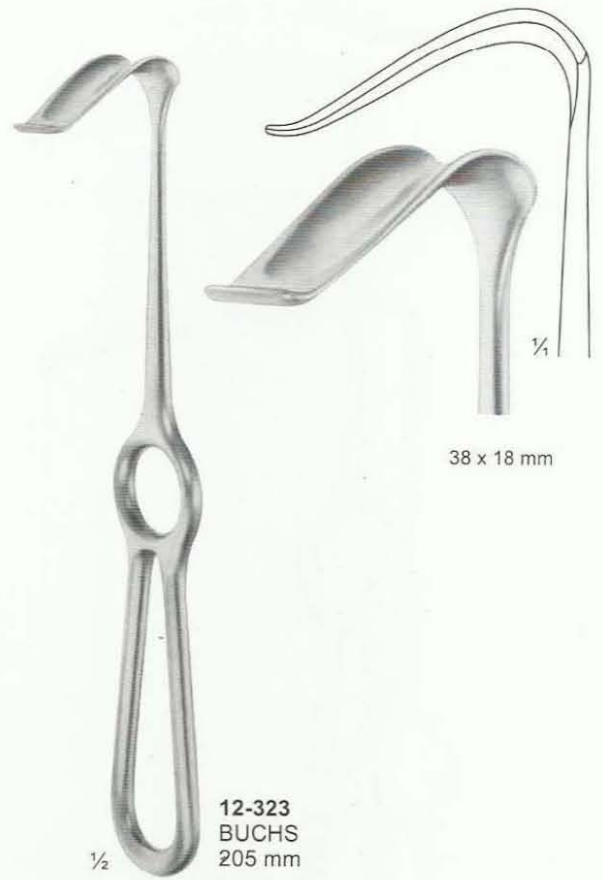

12-323
BUCHS
205 mm

12-325
KOCHER
230 mm



12-320 - 322
MIDDELDORPF

12-324
CASPAR
210 mm

36 x 20 mm

1/4

1/2



1/2
12-326 - 331
HOSEL
250 mm

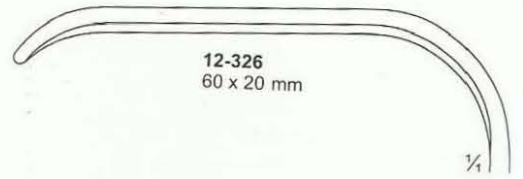

12-326
60 x 20 mm

1/4

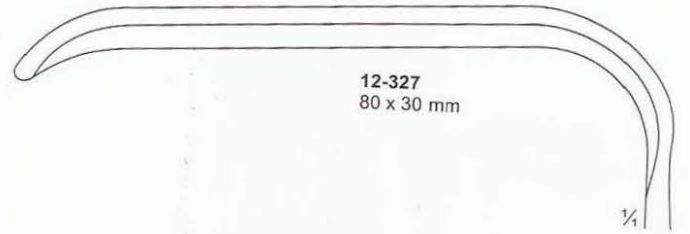

12-327
80 x 30 mm

1/4

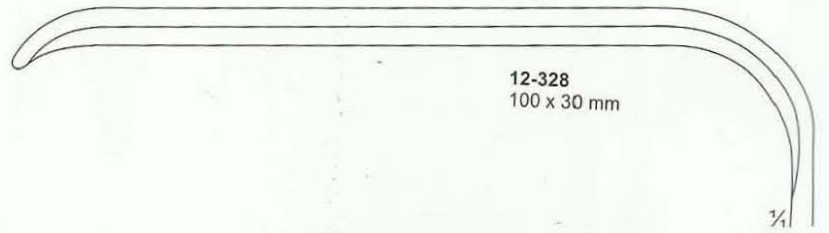

12-328
100 x 30 mm

1/4

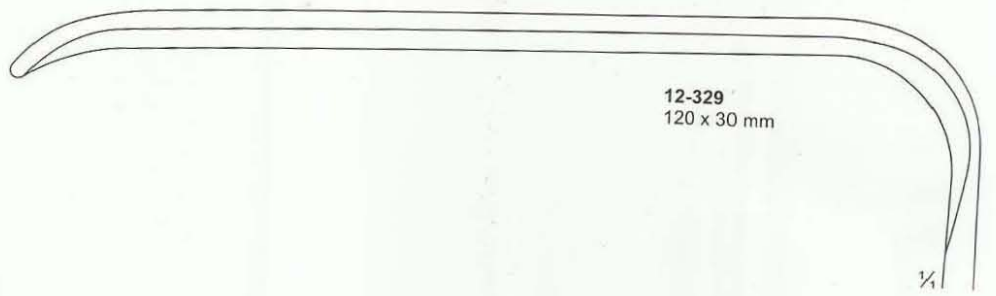

12-329
120 x 30 mm

1/4

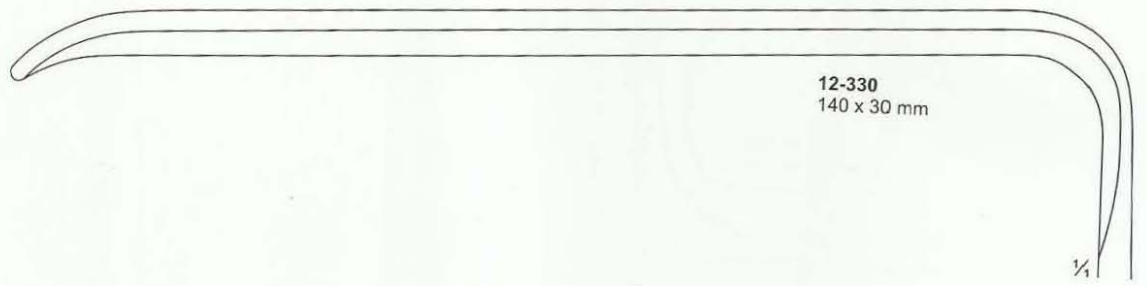

12-330
140 x 30 mm

1/4

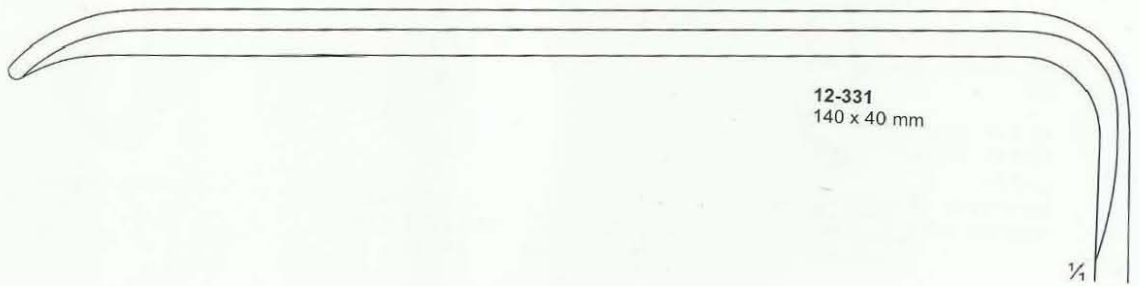

12-331
140 x 40 mm

1/4

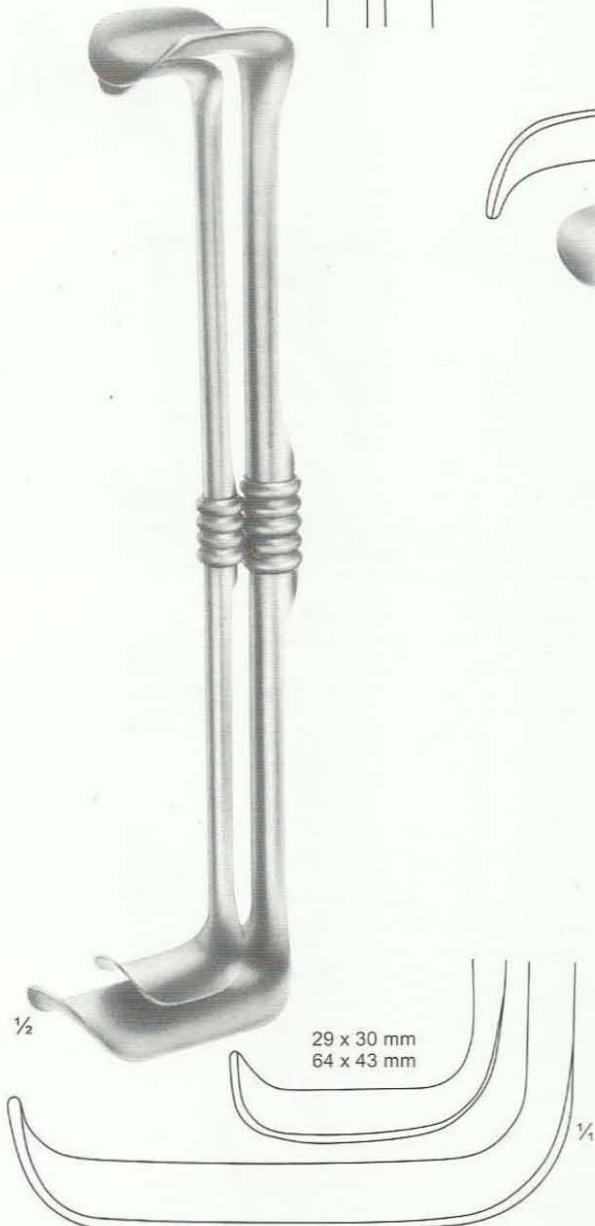
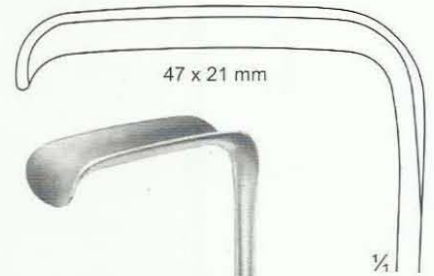
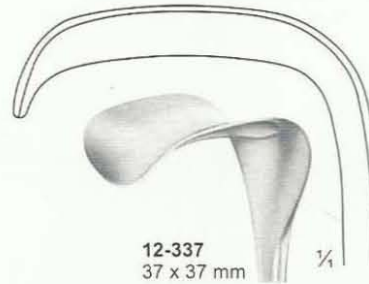
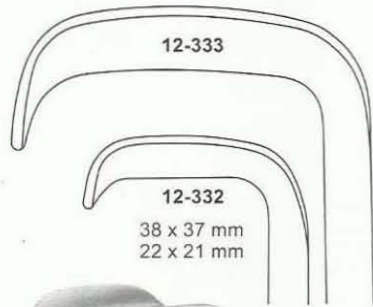

12-332 - 333
RICHARDSON-EASTMAN
Set

12-332 250 mm
12-333 270 mm
12-334
Richardson - Eastman
complete set of 2



12-335 - 337
RICHARDSON
240 mm

1/2

12-338
RICHARDSON
240 mm

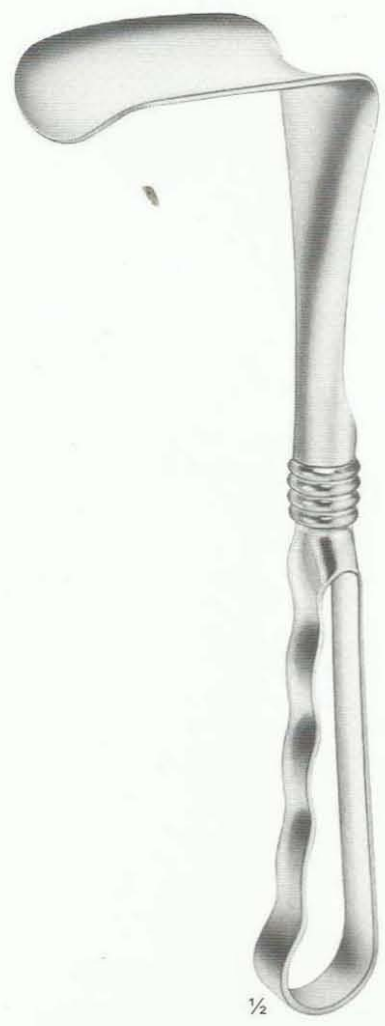
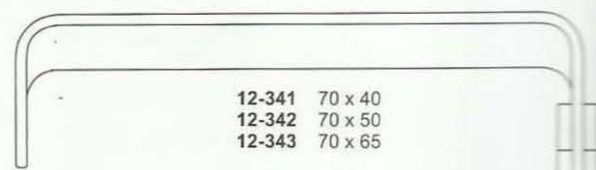
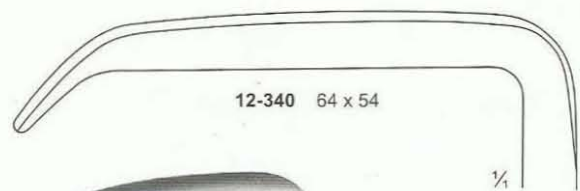
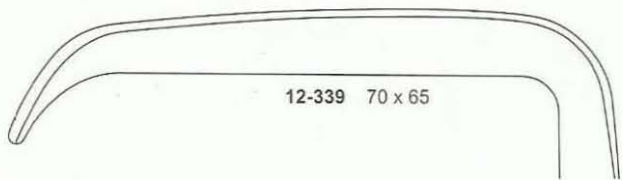

1/2

12-339 - 340
KELLY
260 mm



1/2

12-341 - 343
MORRIS
245 mm



12-344
52 x 16
210 mm

12-345
76 x 25
230 mm

12-346
89 x 50
255 mm

12-344 - 346
MEYERDING



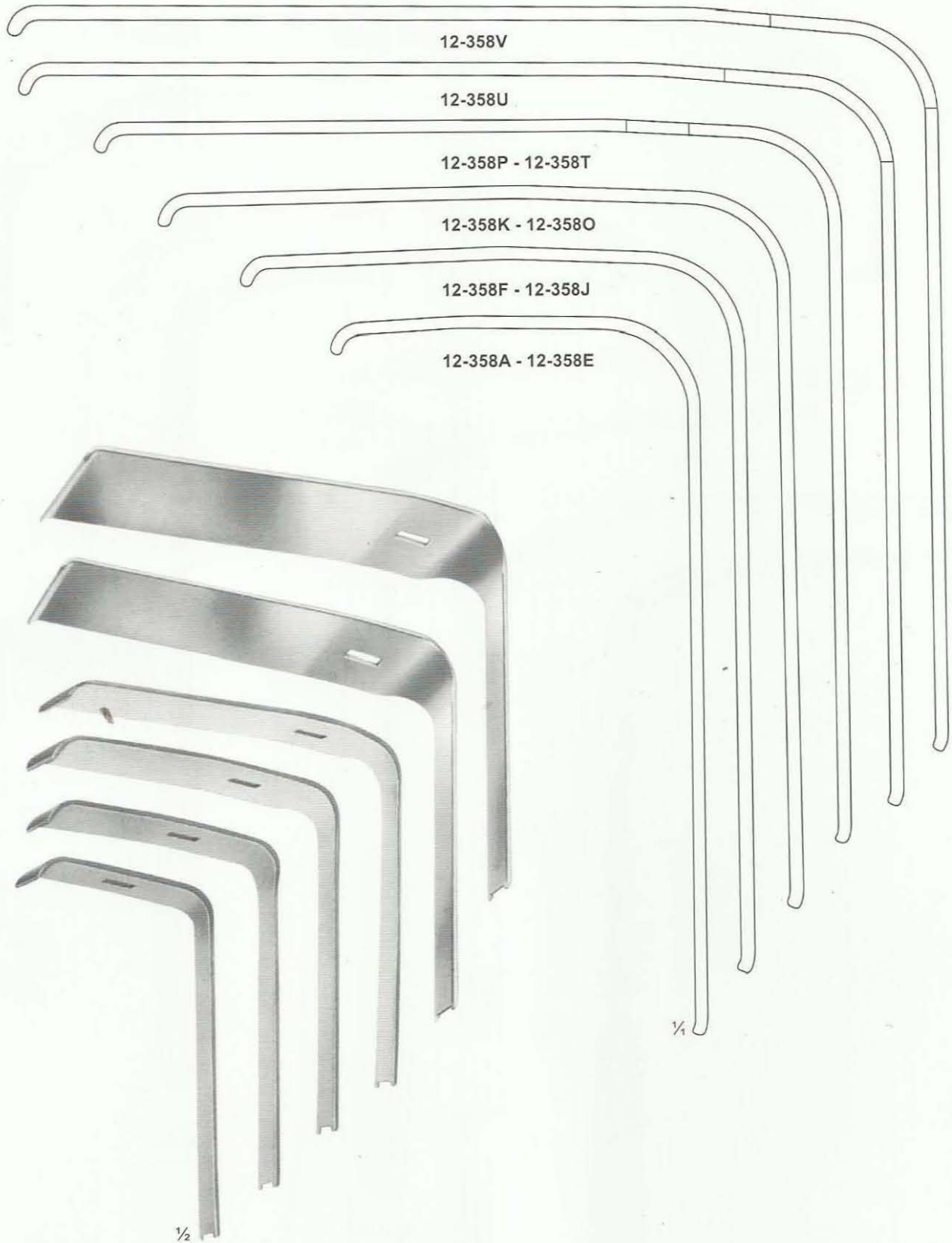

12-358

Retractor blades for handles

Depth	Width						
	14mm	18mm	22mm	26mm	30mm	40mm	50mm
55mm	12-358A	12-358B	12-358C	12-358D	12-358E	-	-
75mm	12-358F	12-358G	12-358H	12-358I	12-358J	-	-
95mm	12-358K	12-358L	12-358M	12-358N	12-358O	-	-
115mm	12-358P	12-358Q	12-358R	12-358S	12-358T	-	-
135mm	-	-	-	-	-	12-358U	-
145mm	-	-	-	-	-	-	12-358V

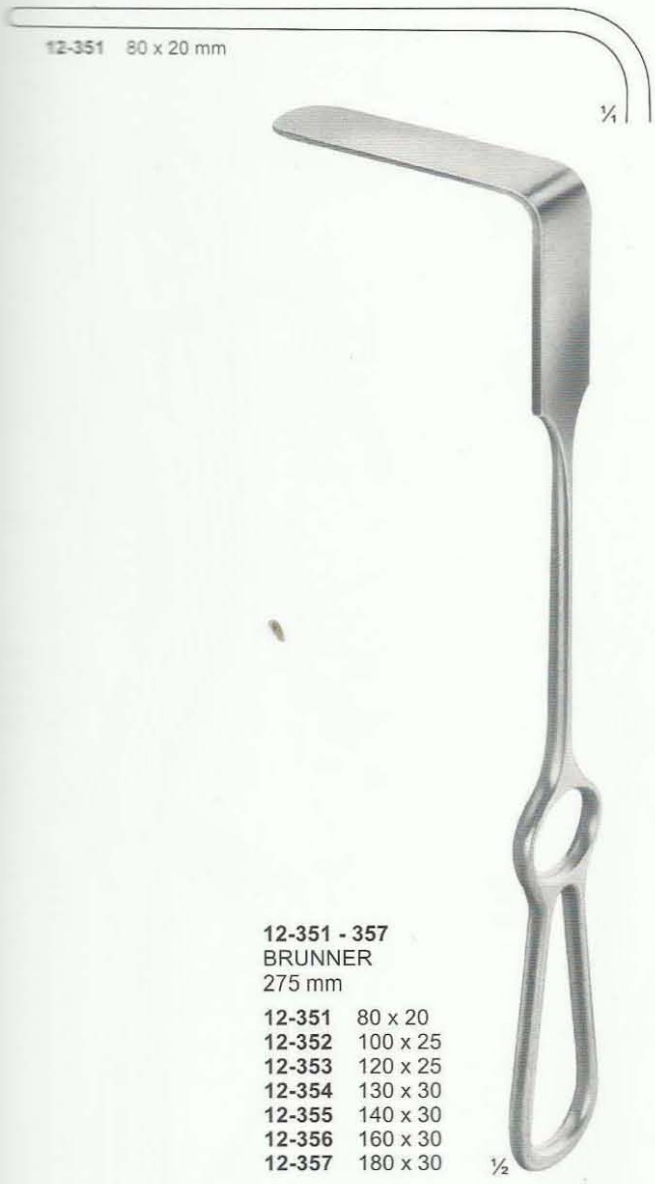

- 12-351 - 357
 BRUNNER
 275 mm
- 12-351 80 x 20
 - 12-352 100 x 25
 - 12-353 120 x 25
 - 12-354 130 x 30
 - 12-355 140 x 30
 - 12-356 160 x 30
 - 12-357 180 x 30

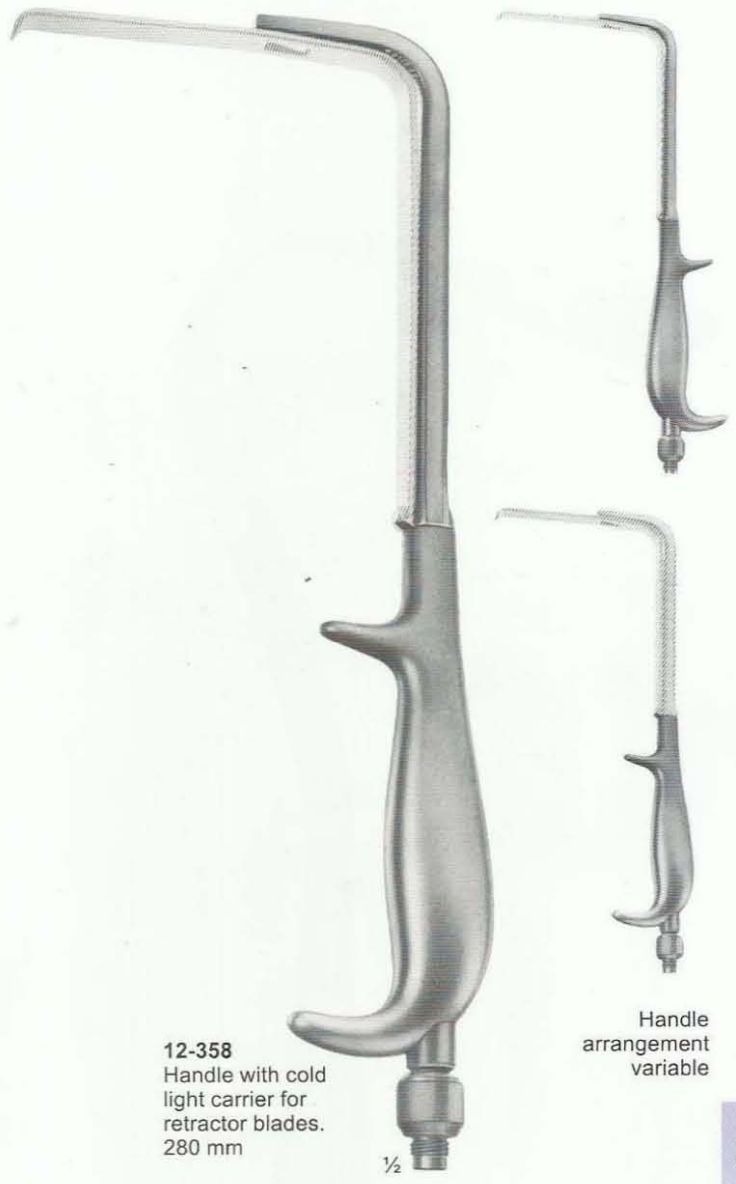

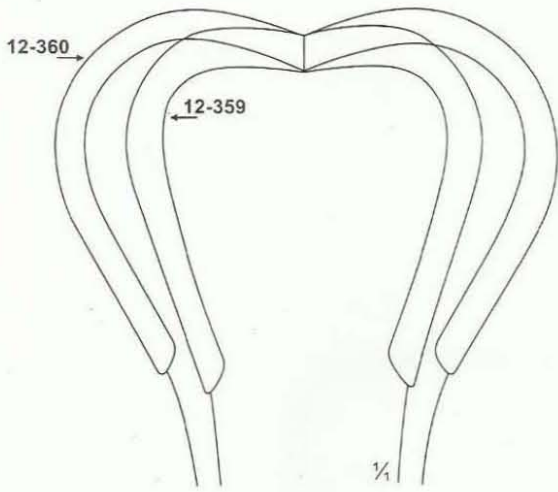

12-359 - 360
HARRINGTON
12-359 123 x 45 mm
12-360 123 x 64 mm
Flexible
295 mm

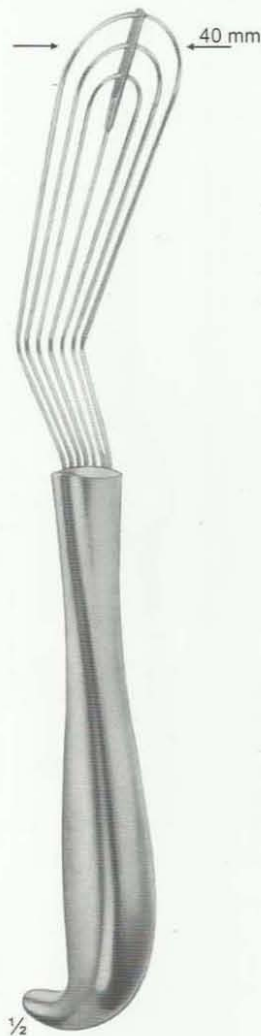

12-361
ALLISON
255 mm



12-362
ALLISON
320 mm

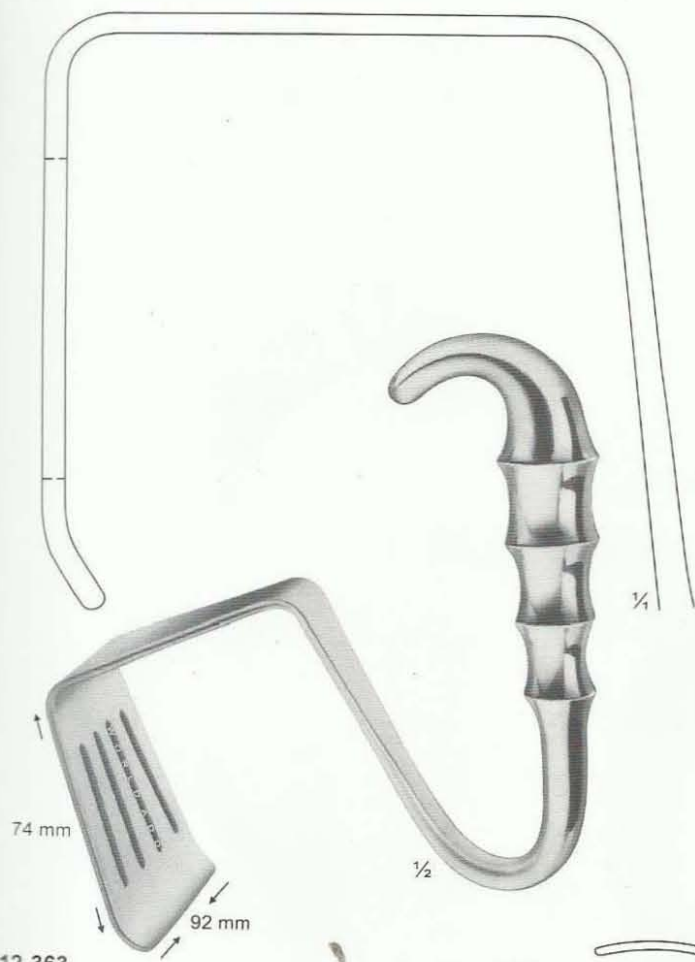

12-363
DAVIDSON
Scapula Retractor
195 mm



12-364
ZENKER
240 mm

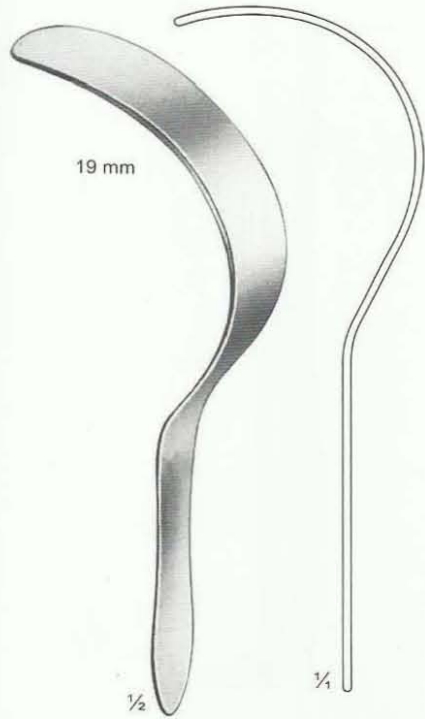

12-365
DEAVER
180 mm
Fig. 000

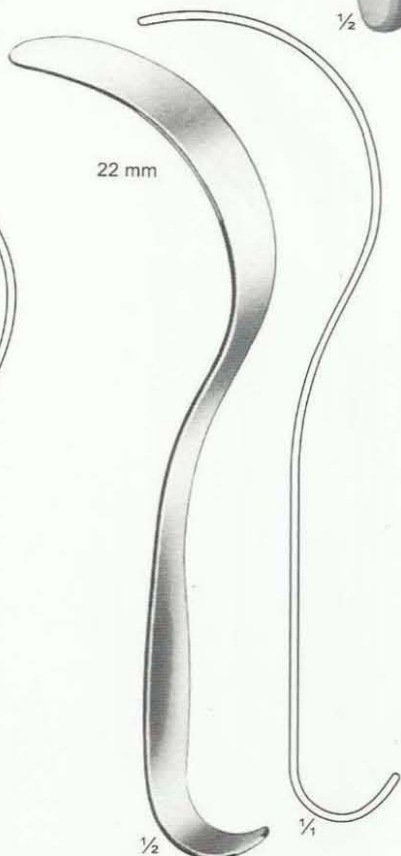

12-366
DEAVER
215 mm
Fig. 00



12-367
DEAVER
235 mm
Fig. 0

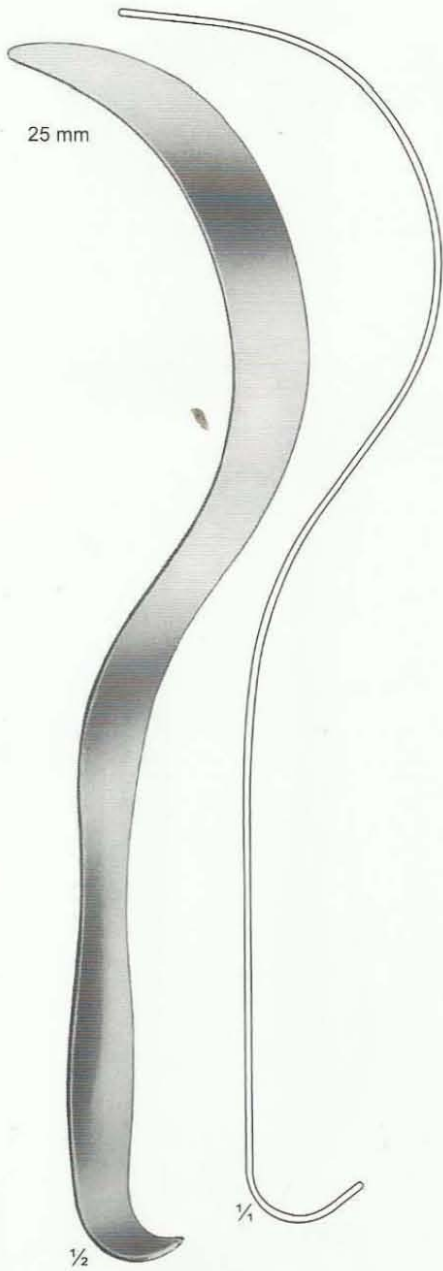

12-368
DEAVER
300 mm
Fig. 1



12-369
DEAVER
315 mm
Fig. 2



12-370
DEAVER
365 mm
Fig. 2 1/2



12-371
DEAVER
300 mm
Fig. 3

12-372
DEAVER
310 mm
Fig. 4

12-373
DEAVER
320 mm
Fig. 5

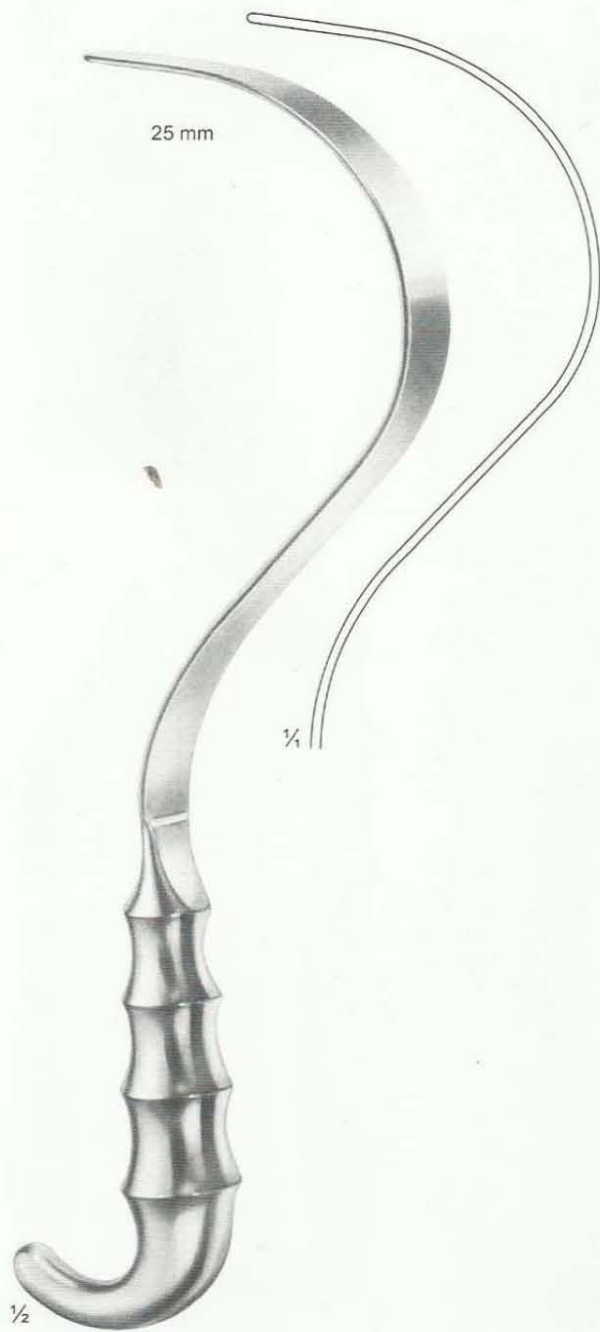

12-374
DEAVER
310 mm
Fig. 1

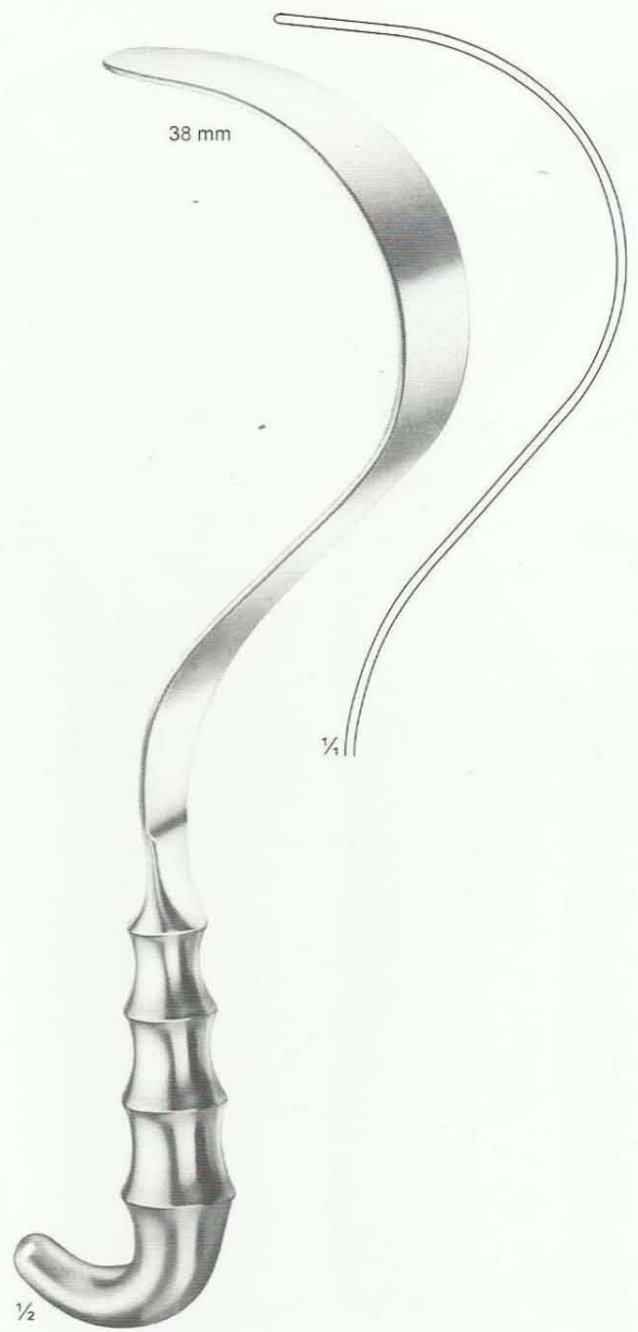

12-375
DEAVER
310 mm
Fig. 3



12-376
DEAVER
305 mm
Fig. 4

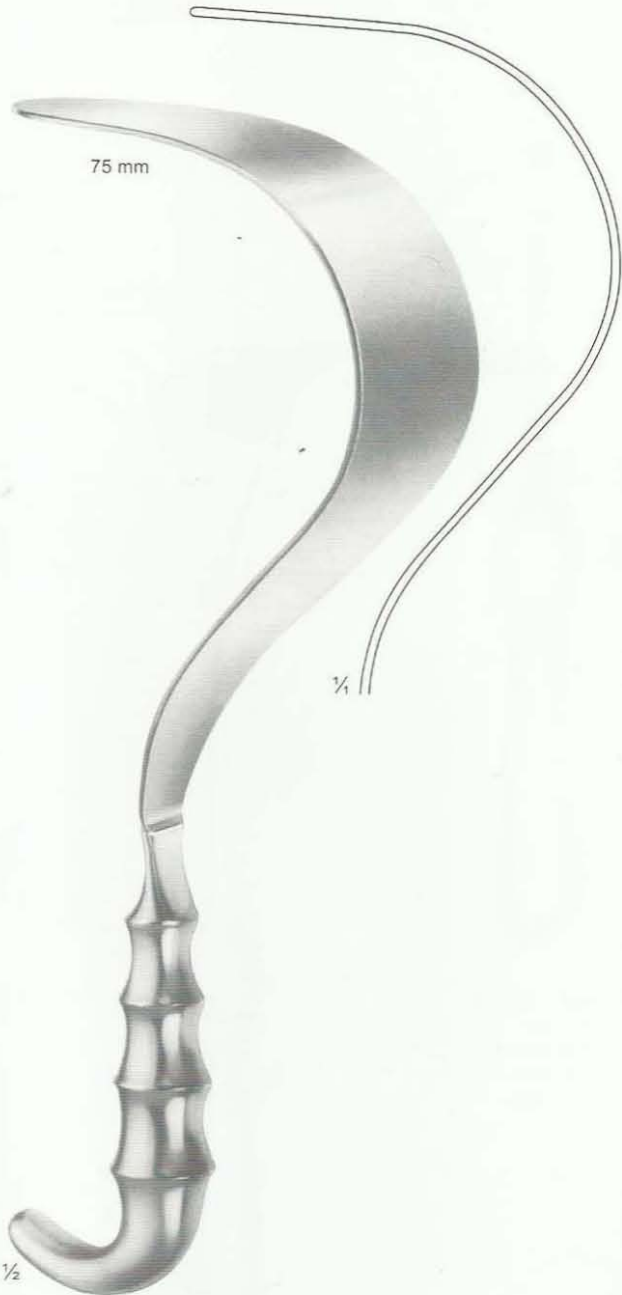

12-377
DEAVER
310 mm
Fig. 5

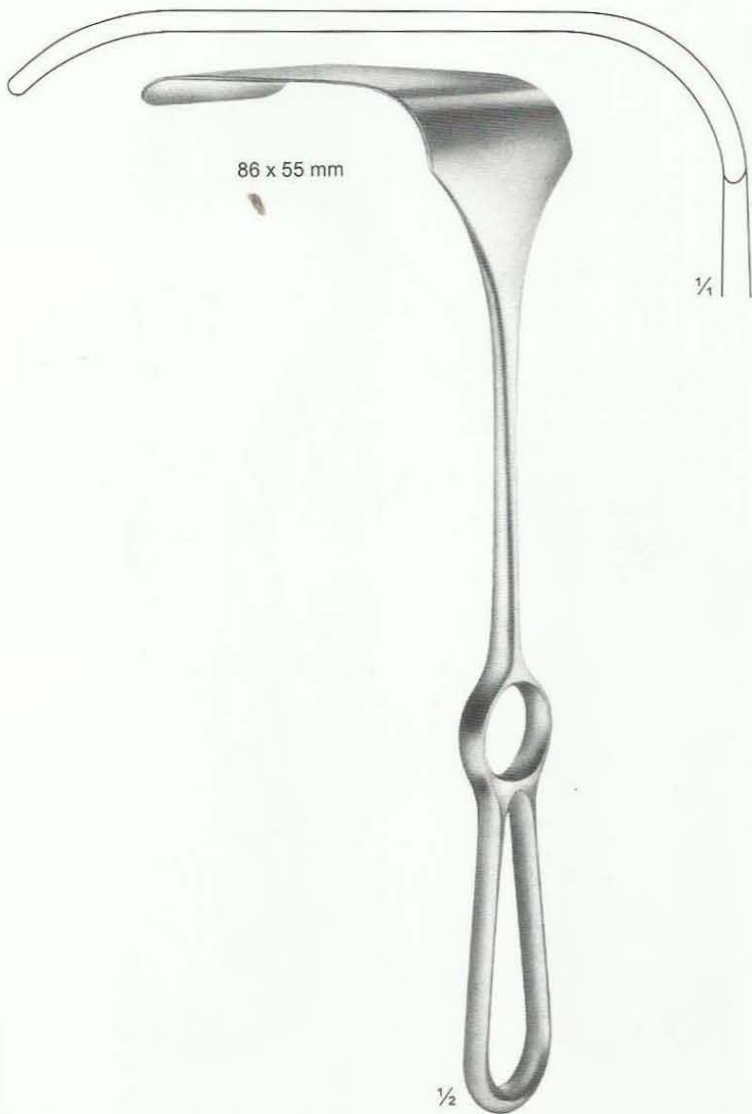

12-378
MIKULICZ
255 mm



12-379
MIKULICZ
250 mm

Retractors For Deep Surgery
(Abdominal Retractors)

12-382 150 x 39 mm
12-383 150 x 57 mm

12-380 121 x 50 mm
12-381 147 x 50 mm

12-382 - 383
KELLY

12-382 150 x 39 mm
12-383 150 x 57 mm
260 mm

12-380 - 381
MIKULICZ
12-380 121 x 50 mm
12-381 147 x 50 mm
Liver Retractor
250 mm



- 12-395 Fig.1 32 x 40 mm
- 12-396 Fig.2 34 x 50 mm
- 12-397 Fig.3 41 x 60 mm
- 12-398 Fig.4 46 x 75 mm
- 12-399 Fig.5 64 x 85 mm

12-384 - 394
DOYEN
240 mm

12-395 - 399
FRITSCH
240 mm

12-400
DOYEN
250 mm

Length of Blades	Width of Blades		
	35mm	45mm	60mm
62mm	12.384	12.387	12.391
92mm	12.385	12.388	12.392
122mm	12.386	12.389	12.393
160mm		12.390	12.394

- 12-401-405
ROCHARD
310 mm
12-401 48 x 90 mm
12-402 48 x 105 mm
12-403 48 x 120 mm
12-404 48 x 135 mm
12-405 48 x 155 mm

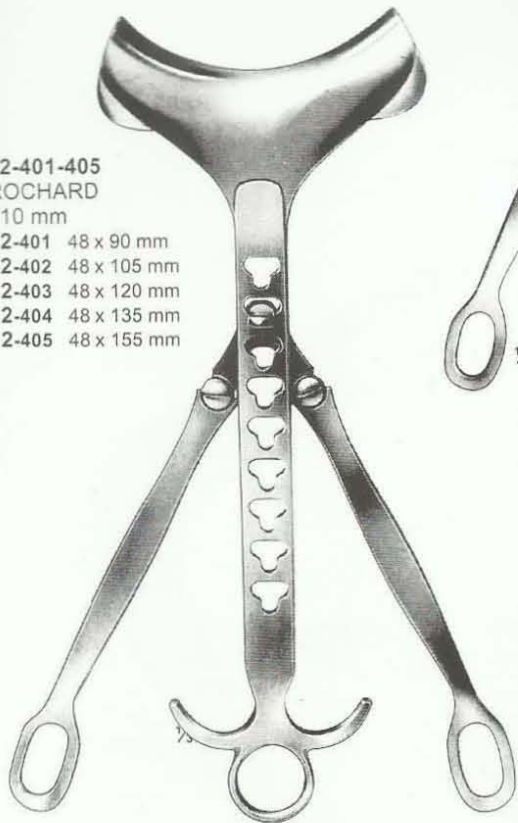

12-406
ROCHARD
Fixation device for 12-401-405

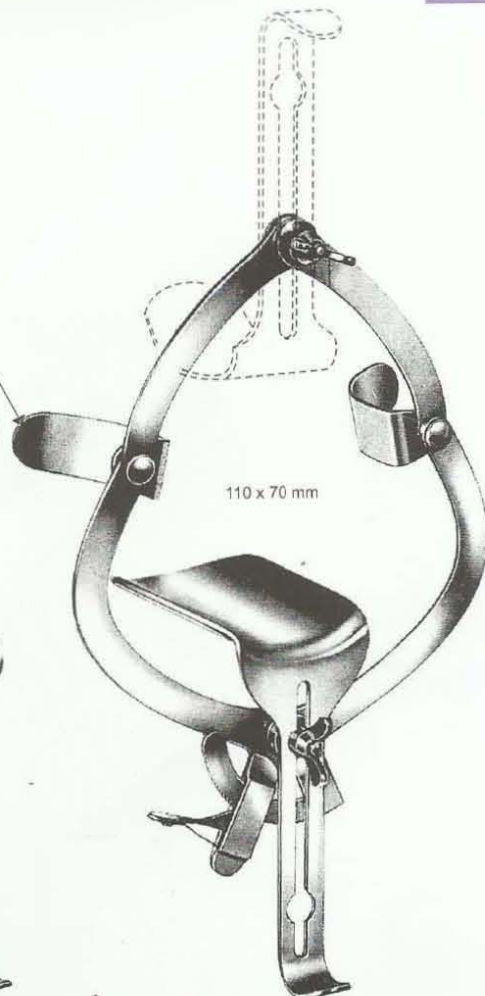
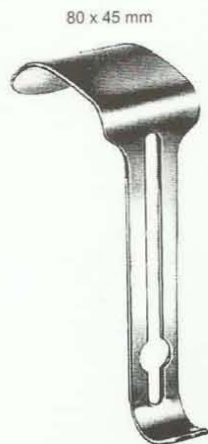

O' Sullivan-O' Connor
12-401A
Adult
12-401B
Baby

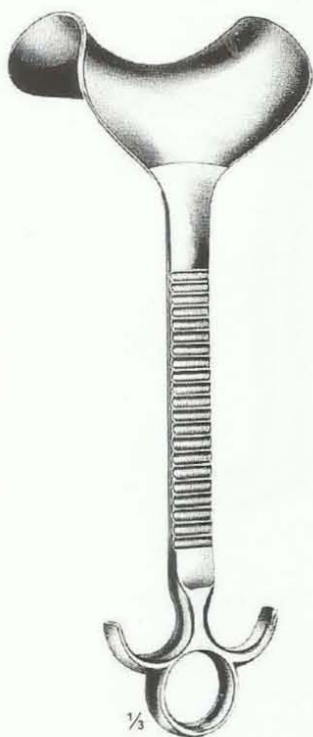

- 12-407 - 410
DOYEN
280 mm
12-407 48 x 90 mm
12-408 48 x 105 mm
12-409 48 x 120 mm
12-410 48 x 135 mm



12-411
DOYEN-CHILD
Fixation device
220 mm



12-412
Chain (12-412A)
with weight (12-412B)
645g
790 mm

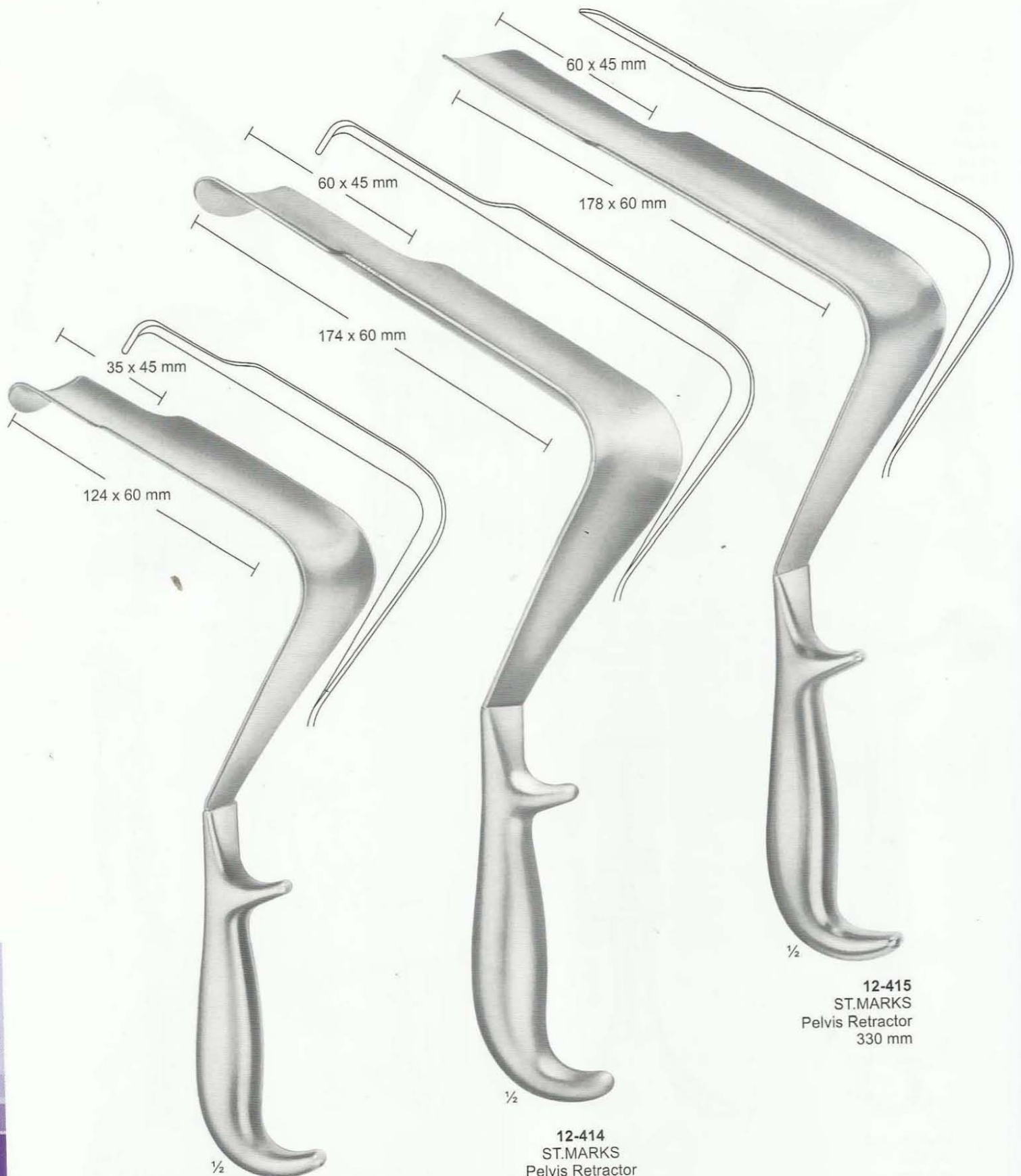

12-413
ST.MARKS
Pelvis Retractor

12-414
ST.MARKS
Pelvis Retractor
330 mm

12-415
ST.MARKS
Pelvis Retractor
330 mm



12-416
LERICHE
255 mm

12-417
KUMMEL
Malleable
285 mm

12-418
MIKULICZ
29 mm
250 mm

12-419 - 420
KADER
12-419 30 mm
12-420 40 mm
270 mm

Abdominal- and Intestinal Spatulas

Oral Instruments Cheek & Nasal Retractors, Alar Hooklet



Mayo
12-421S
17 cm

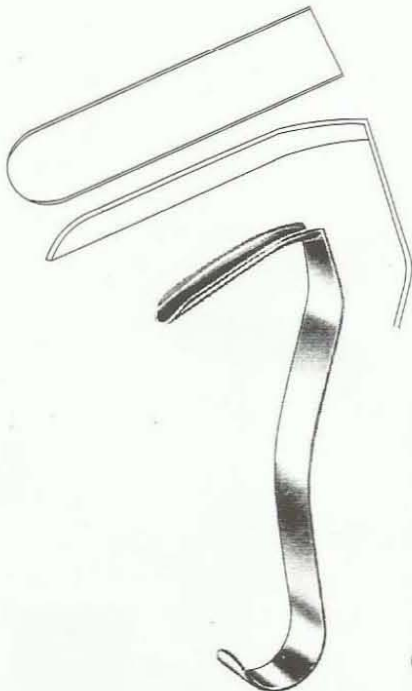

Converse
12-421C
10.5 cm
44 x 11 mm blade

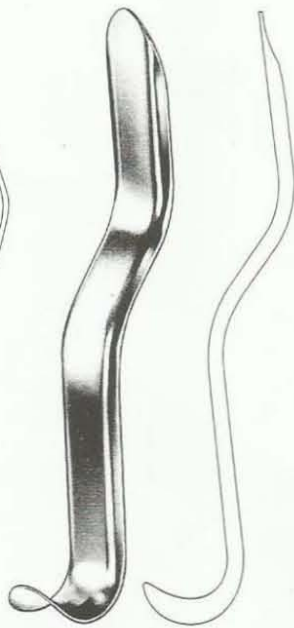

Cawood Minnesota
12-421M
15 cm
20 mm

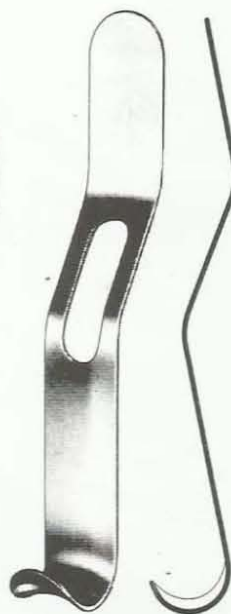

12-421MM
14.5 cm
Fenestrated



Doyen
12-426S
13 cm
24/30 mm
12-426SS
16 cm
30/34 mm



Tobold
12-426T
12 cm



63 mm
45 mm
1/3
12-421
REVERDIN
285 mm



40 mm
50 mm
1/3
12-422
HABERER
Malleable
305 mm



12-423 - 425
12-423 30 mm
12-424 40 mm
12-425 50 mm
Malleable
330 mm



17 mm
25 mm
1/2
12-426
TUFFIER
Malleable
200 mm



12-427
BOSE
60 mm



12-428
FINSEN
50 mm



12-429
FINSEN
70 mm



12-430
FINSEN modif.
75 mm



12-431
45 mm



12-432
55 mm



12-433
MUELLER
65 mm



12-434
100 mm



12-435



12-436



12-435 - 436

12-435 70 mm
12-436 100 mm

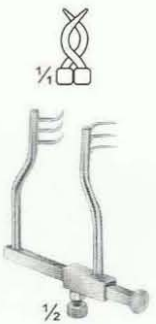

12-437
LOGAN
modif. REILL
50 mm

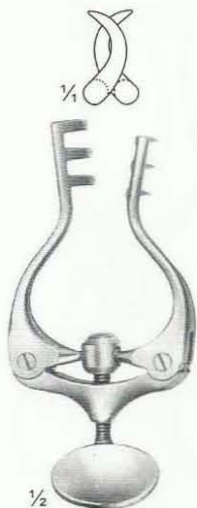

12-438
JANSSEN
100 mm

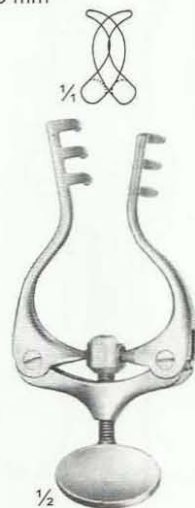

12-439
JANSSEN
100 mm

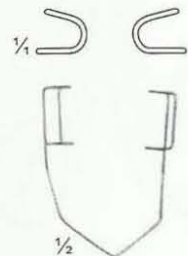

12-440
BARRAQUER
45 mm

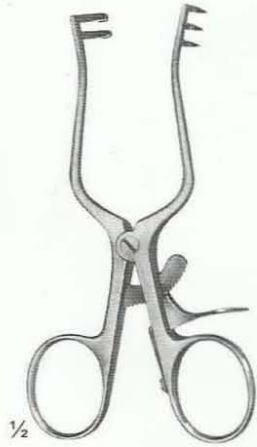

12-441
WEITLANER
Sharp
110 mm

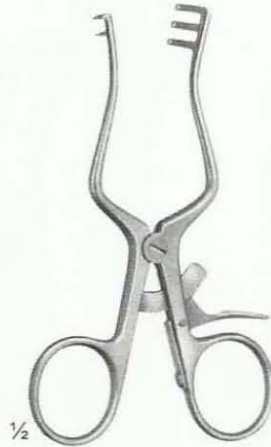

12-442
WEITLANER
Semi-Sharp
110 mm

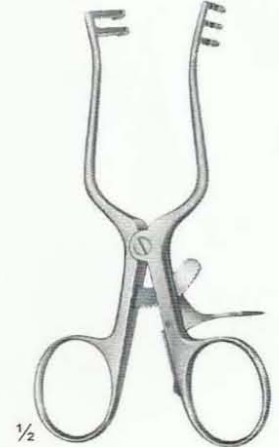

12-443
WEITLANER
Blunt
110 mm

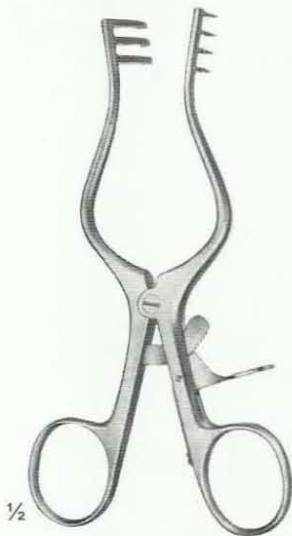

12-444
WEITLANER
Sharp
130 mm

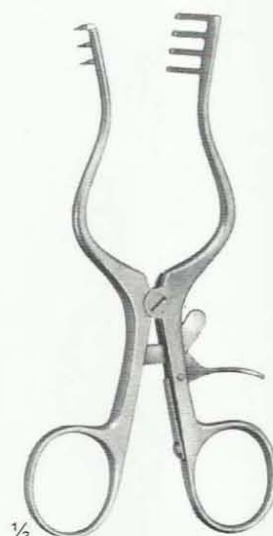

12-445
WEITLANER
Semi-Sharp
130 mm

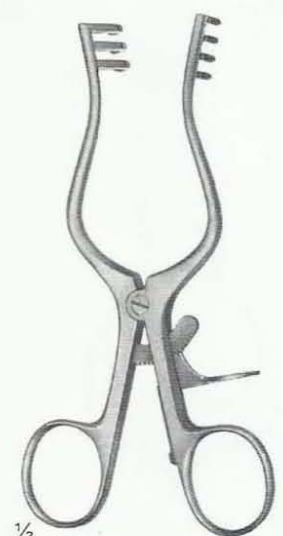

12-446
WEITLANER
Blunt
130 mm

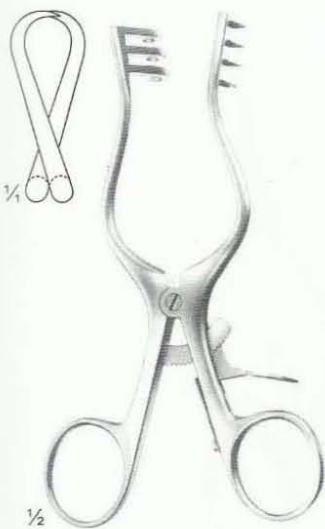

12-447
WEITLANER
Sharp
130 mm

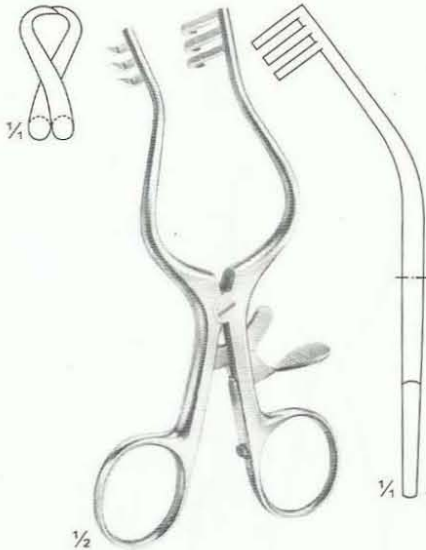

12-448
WULLSTEIN
Sharp
130 mm

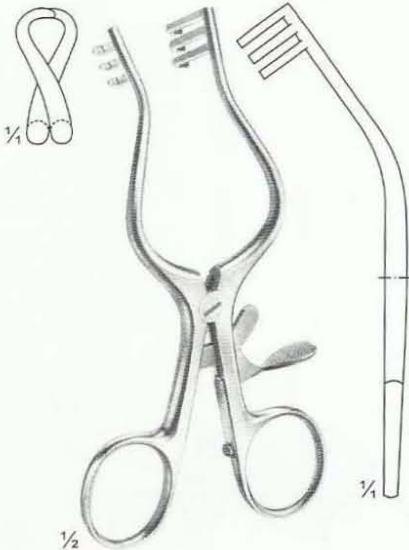

12-449
WULLSTEIN
Blunt
130 mm

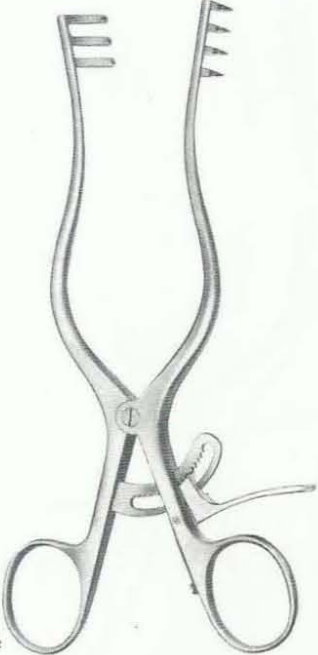

12-450
WEITLANER
Sharp
165 mm

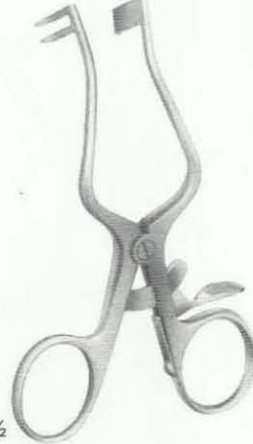

12-451
PLESTER
Blunt
110 mm

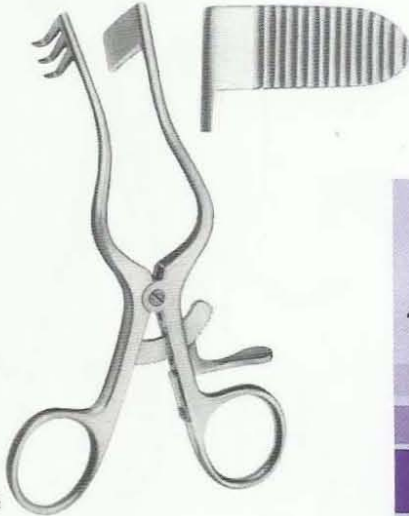

12-452
PERKINS
Blunt
130 mm

Self-Retaining Retractors



12-453
ADSON-BABY
 Blunt
 140 mm

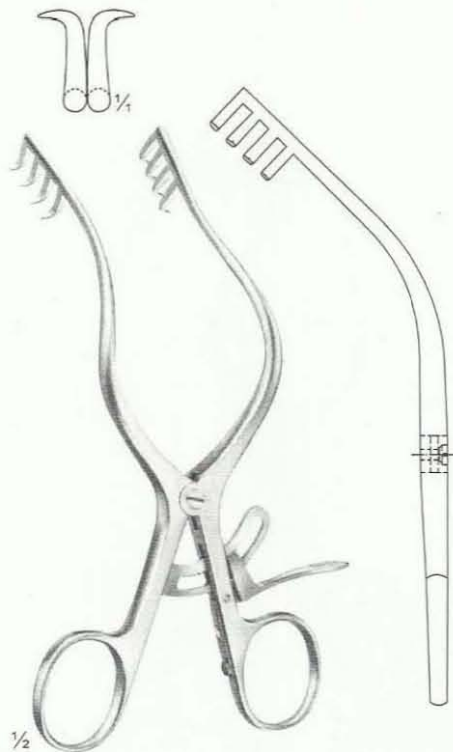

12-454
MOLLISON
 Sharp
 155 mm

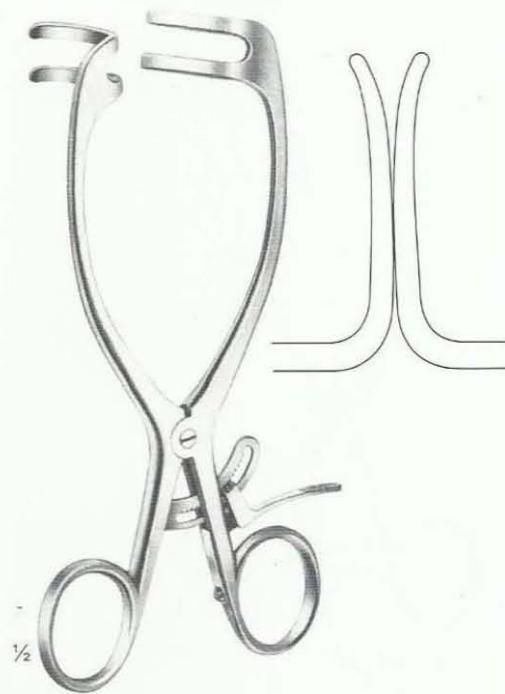

12-455
MAYO-ADAMS
 165 mm

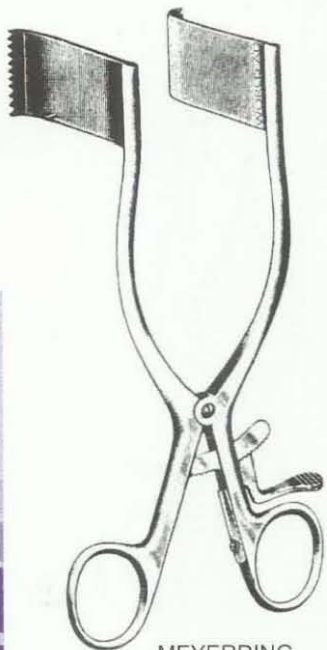

MEYERDING
12-455A 25 x 60 mm blade
12-455B 25 x 55 mm blade
12-455C 25 x 35 mm blade
12-455D 22 x 60 mm blade

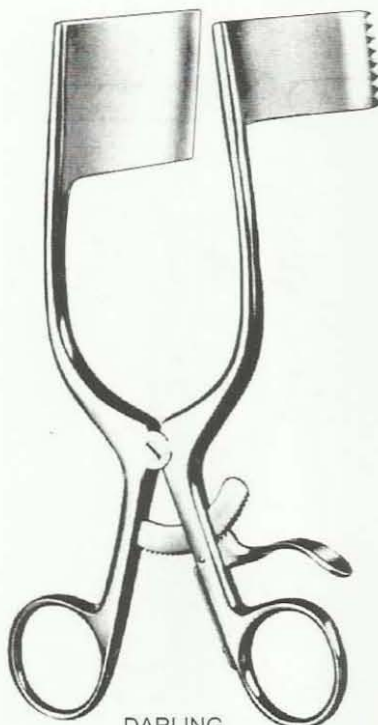

DARLING
12-455E
 18 cm
 (Poplitea)

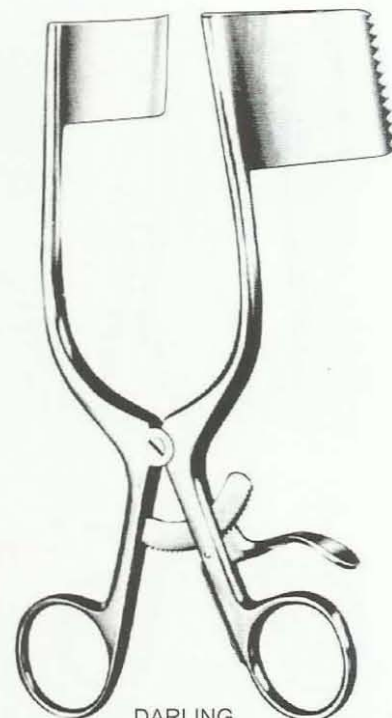

DARLING
12-455F
 18 cm
 (Poplitea)

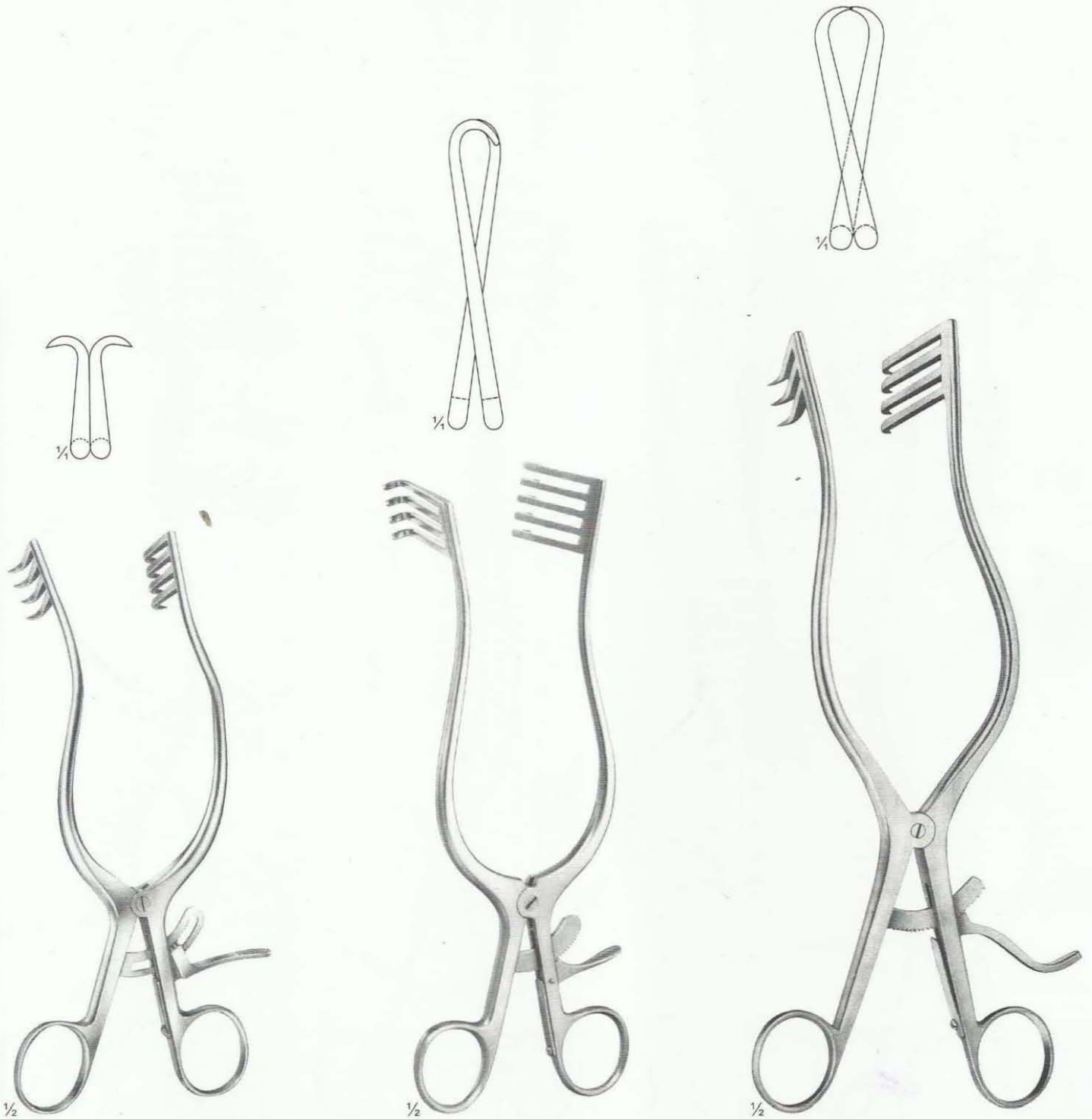

12-456
ANDERSON-ADSON
Sharp
190 mm

12-457
NORFOLK and
NORWICH
Blunt
220 mm

12-458
ADSON
Sharp
265 mm

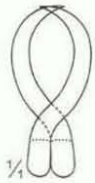

$\frac{1}{4}$
Sharp

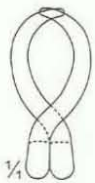

$\frac{1}{4}$
Semi-Sharp



$\frac{1}{4}$
Semi-Sharp

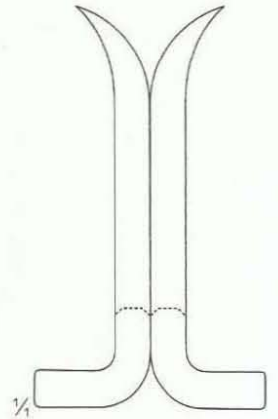

$\frac{1}{4}$

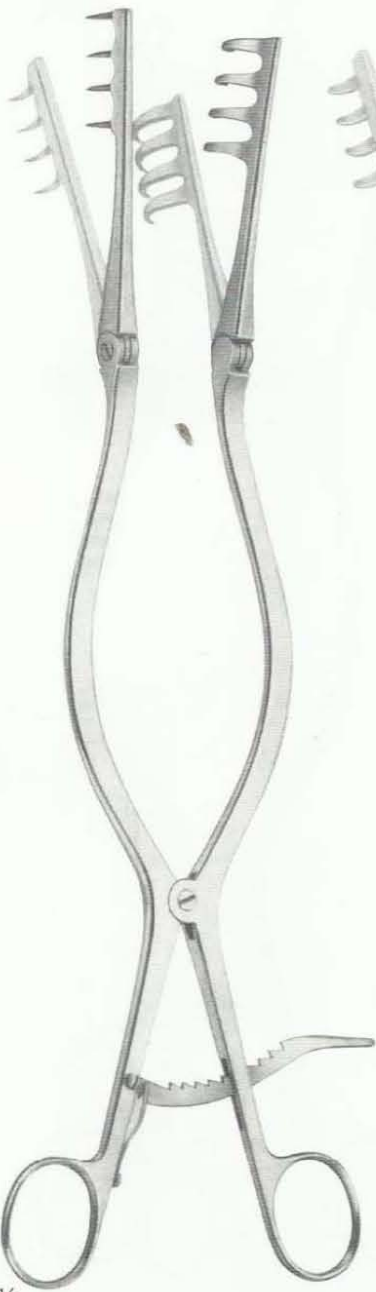

$\frac{1}{2}$

12-459
BECKMANN-ADSON
Sharp



12-460
BECKMANN-ADSON
Semi-Sharp
310 mm

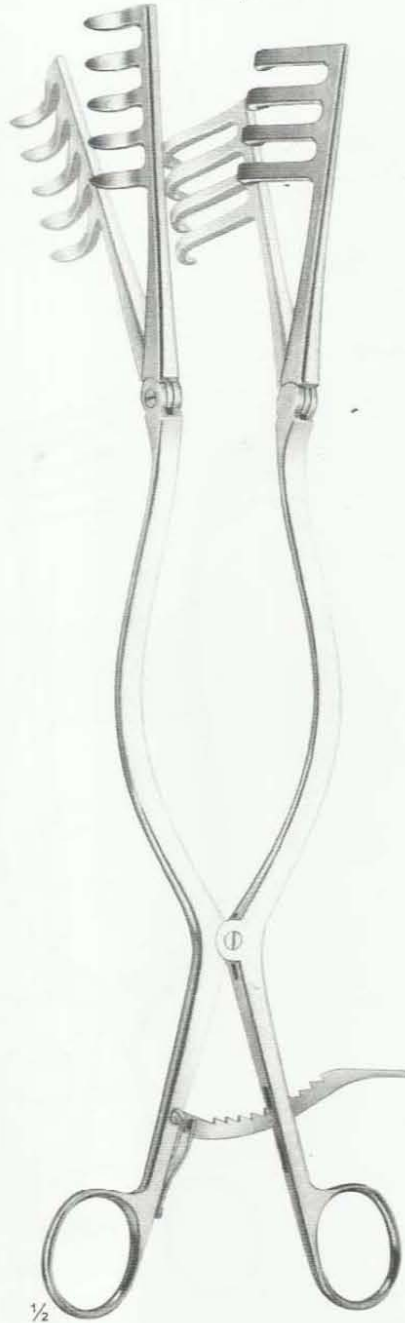

$\frac{1}{2}$

12-461
ADSON
Semi-Sharp

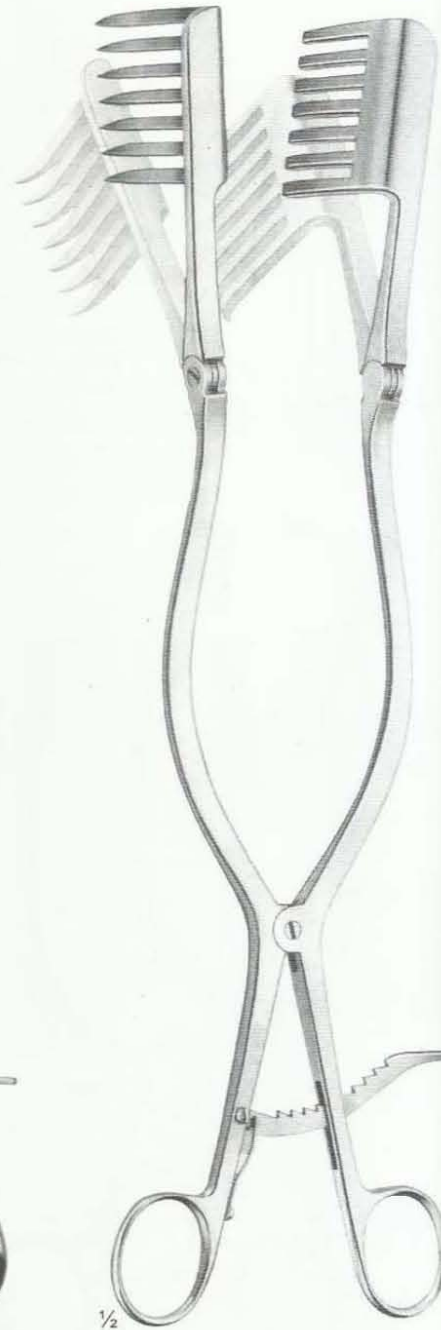

$\frac{1}{2}$

12-462
BECKMANN-EATON
Sharp



12-463
JOLL (FRIEDMAN)
 Thyroid- and Vaginal Retractor
 155 mm

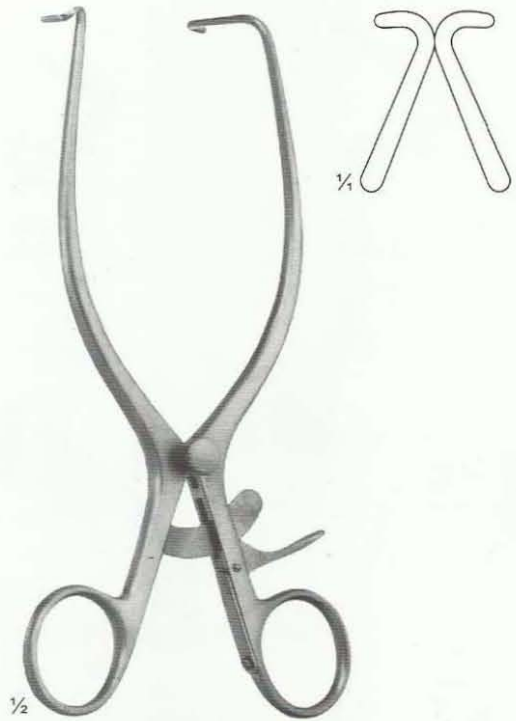

12-464
JACKSON BURROWS
 Retractor, blunt
 185 mm

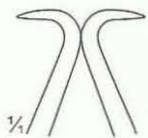

12-465
GELPI
 Vaginal Retractor
 135 mm

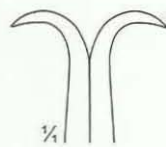

12-466
GELPI
 Skin- and Vaginal Retractor
 175 mm

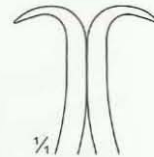

12-467
DE BAKAY
 Femur Retractor
 145 mm



Scoville
12-469A
50 mm deep
Blunt

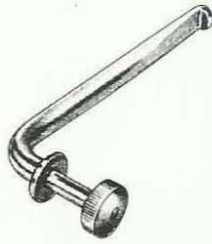

Scoville
12-469B
70 mm deep
Blunt



Scoville
12-469C
50 mm deep
Sharp



Scoville
12-469D
70 mm deep
Sharp

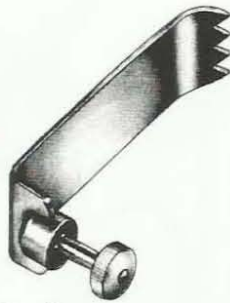

Scoville
12-469E 60 x 25 mm
12-469F 64 x 50 mm
12-469G 88 x 25 mm
Toothed



12-469
62 x 52 mm
PR= Pair



12-470
47 x 51 mm

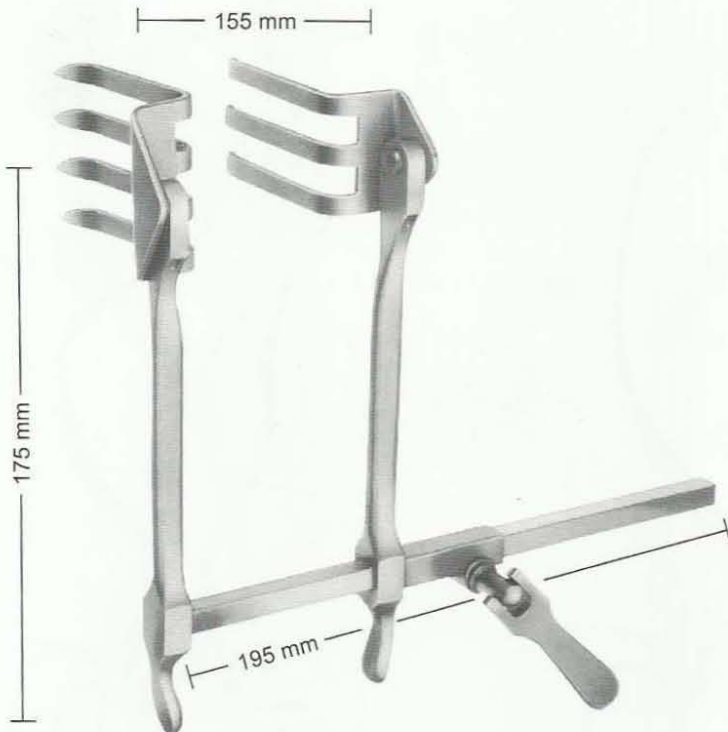

12-468
SCOVILLE-RICHTER
Retractor (**12-468A**) with 1 pair
blades (**12-469**) reversible type.
The Retractor bar and shanks



12-471
30 x 40 mm

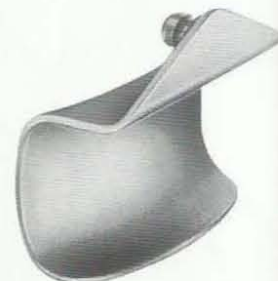

12-472
37 x 62 mm



12-473
CLOWARD modif.
Spreader Only
Consisting of:
12-473 A Spreader Only 10"
12-474 1 Blade
12-475 1 Blade
12-476 1 Blade
12-477 1 Blade
12-478 1 Blade



Blades only used for 12-473 A



12-473
CLOWARD modif.
Spreader Only
Consisting of:
12-473 A Spreader Only 10"
12-474 1 Blade
12-475 1 Blade
12-476 1 Blade
12-477 1 Blade
12-478 1 Blade



Blades only used for 12-473 A

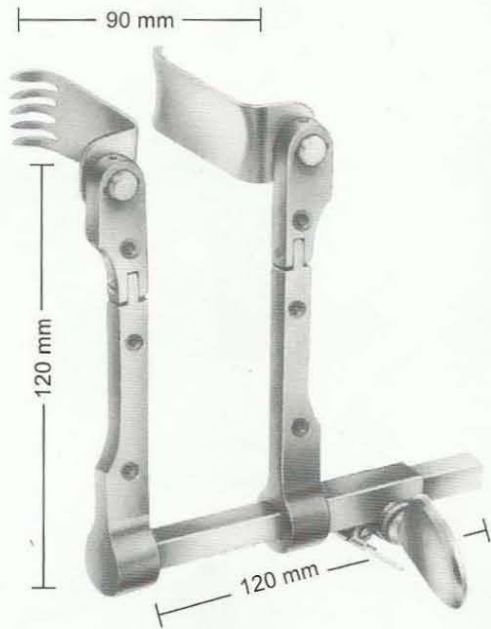

12-484
CASPAR
Retractor, adjustable, consisting of:
5 medial blades (12-485-489) 5 Lateral
blades. (12-490-494) and the retractor
only (12-484B) By Reversing the Screw,
The Retractor Can be Used From Both Sides



12-484 A
CASPAR
Counter retractor, adjustable,
consisting of: 5 blades. (12-495-499)
and the retractor only (12-484C)

— To be used preferably for transverse retraction. —

— To be used preferably for up and down retraction. —



12-485 40 x 23 mm
12-486 45 x 23 mm
12-487 50 x 23 mm
12-488 55 x 23 mm
12-489 60 x 23 mm
Medial blades

12-490 40 x 23 mm
12-491 45 x 23 mm
12-492 50 x 23 mm
12-493 55 x 23 mm
12-494 60 x 23 mm
Lateral blades

12-495 45 x 23 mm
12-496 50 x 23 mm
12-497 55 x 23 mm
12-498 60 x 23 mm
12-499 65 x 23 mm
Blunt blades

12-500 50 x 25 mm
12-501 60 x 25 mm
Blunt blades,
for harvesting of the
fusion graft from the
iliac crest

12-502 40 x 25 mm
12-503 45 x 25 mm
12-504 50 x 25 mm
12-505 55 x 25 mm
12-506 60 x 25 mm
Medial Titan blades
semi transparent to x-ray

12-507 40 x 25 mm
12-508 45 x 25 mm
12-509 50 x 25 mm
12-510 55 x 25 mm
12-511 60 x 25 mm
Lateral Titan blades
semi transparent to x-ray

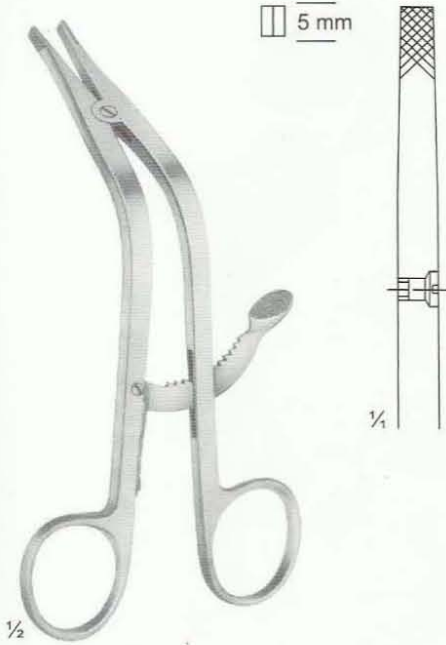

12-512
CLOWARD
155 mm



12-513
CLOWARD
135 mm

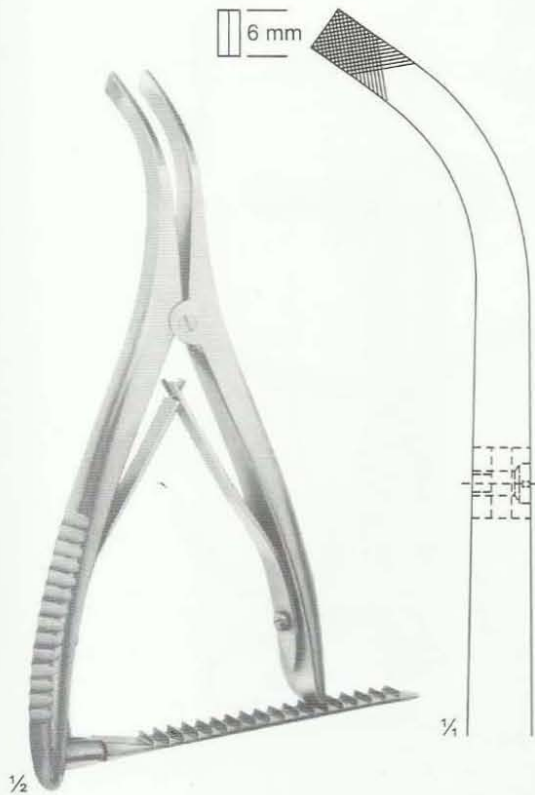

12-514
INGE
170 mm

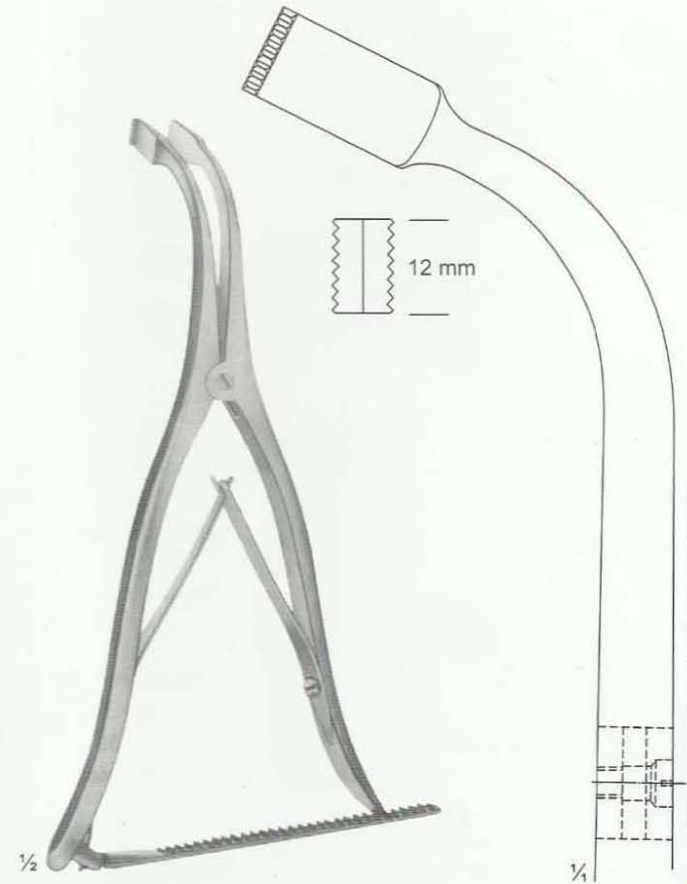

12-515
INGE
275 mm

Abdominal Retractors

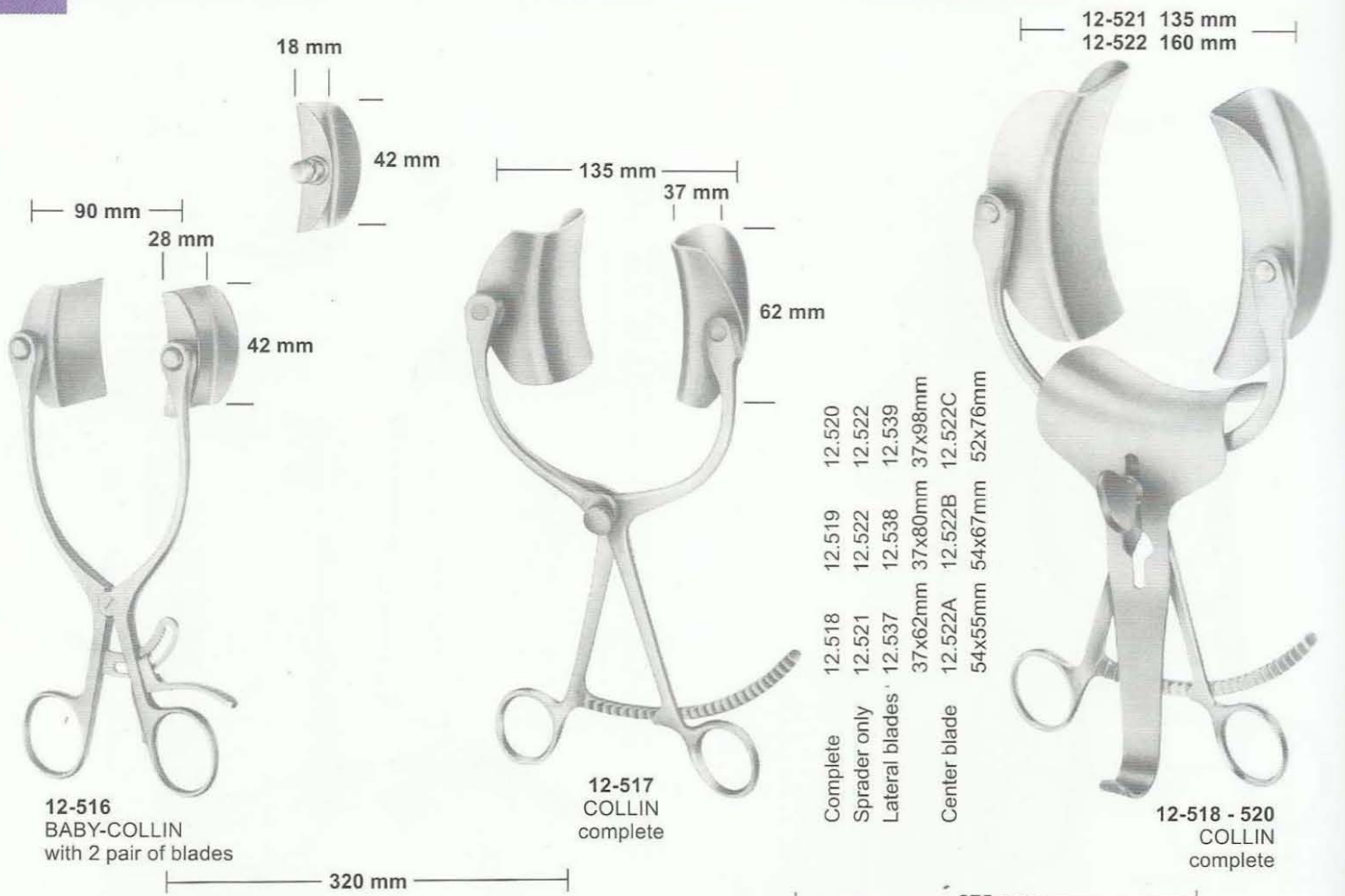

Complete	12.518	12.519	12.520
Spreader only	12.521	12.522	12.522
Lateral blades	12.537	12.538	12.539
Center blade	37x62mm	37x80mm	37x98mm
	12.522A	12.522B	12.522C
	54x55mm	54x67mm	52x76mm



Complete	12.527	12.528
Spreader only	12.529	12.530
Lateral blades	12.542	12.543
Center blade	58x80mm	72x84mm
	12.531	12.532
	54x70mm	72x90mm

12-527 - 528
RICARD
complete

Spreader only 12-529 12-530
Lateral blade 58x80mm 72x84mm



12-533
HOLZBACH
Complete

08-534 Spreader only
08-535 Lateral blade 59x80mm



Lateral blades only
 12-537 37x62 mm
 12-538 37x80 mm
 12-539 37x98 mm



12-540 61x80 mm

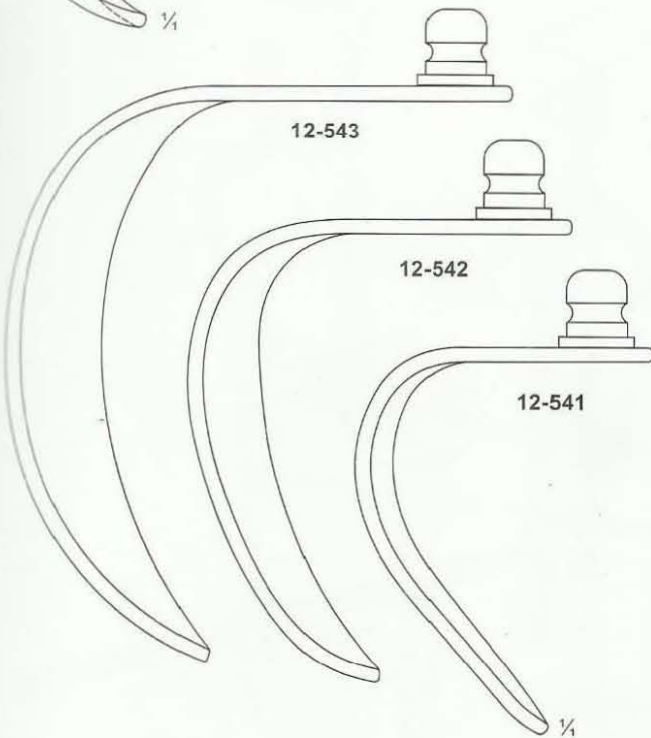

12-541 48x59 mm
 12-542 58x80 mm
 12-543 72x84 mm

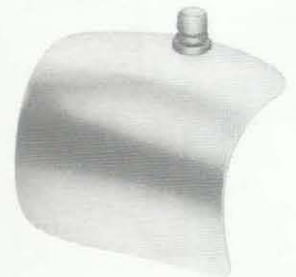

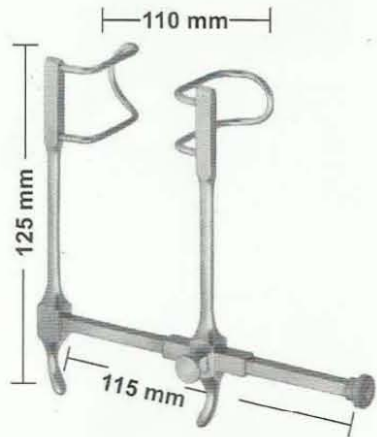

12-545
GOSSET
Blades: 38 mm deep

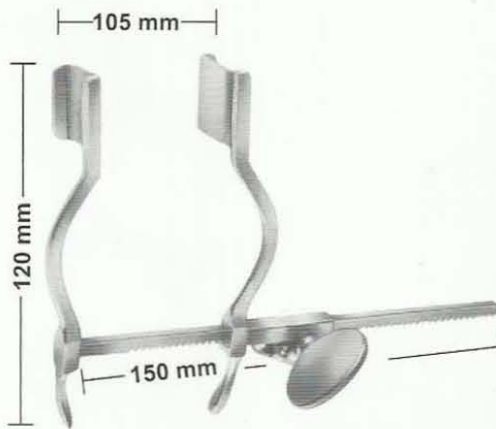

12-546
HERTZLER
Blades 20 X 25 mm

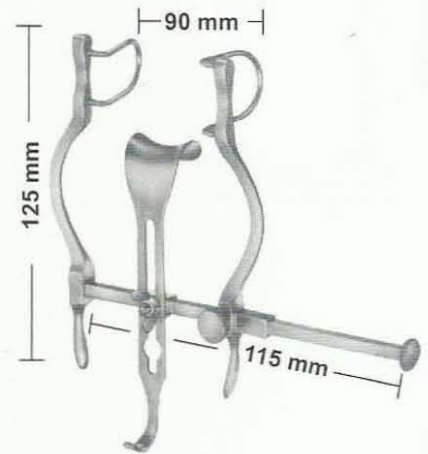

12-547
BALFOUR-BABY
Lateral blades 27 mm deep
(12-548) Center blade 21x24 mm



12-549
GOSSET

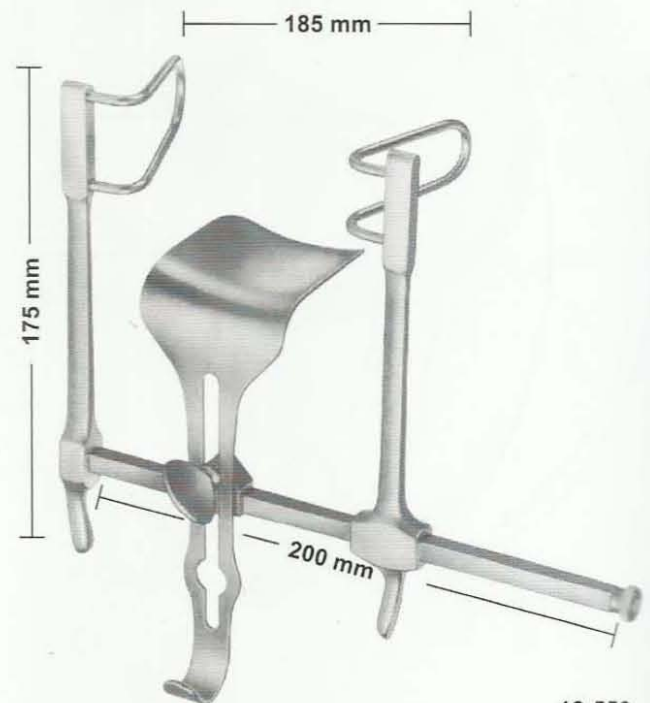

12-550
GOSSET
Lateral blades 58 mm deep
(12-551) Center blade

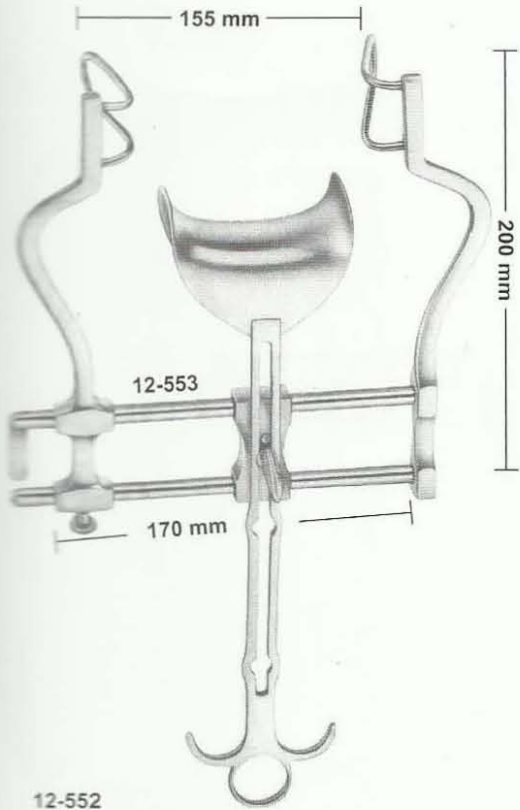

12-552
BALFOUR
Lateral blades 60 mm deep
(12-553) Center blade
47 x 80 mm



12-554
BALFOUR
Lateral blades 105 mm deep
(12-555) Center blade
107x 59 mm



12-556
Center blade only
54x80 mm

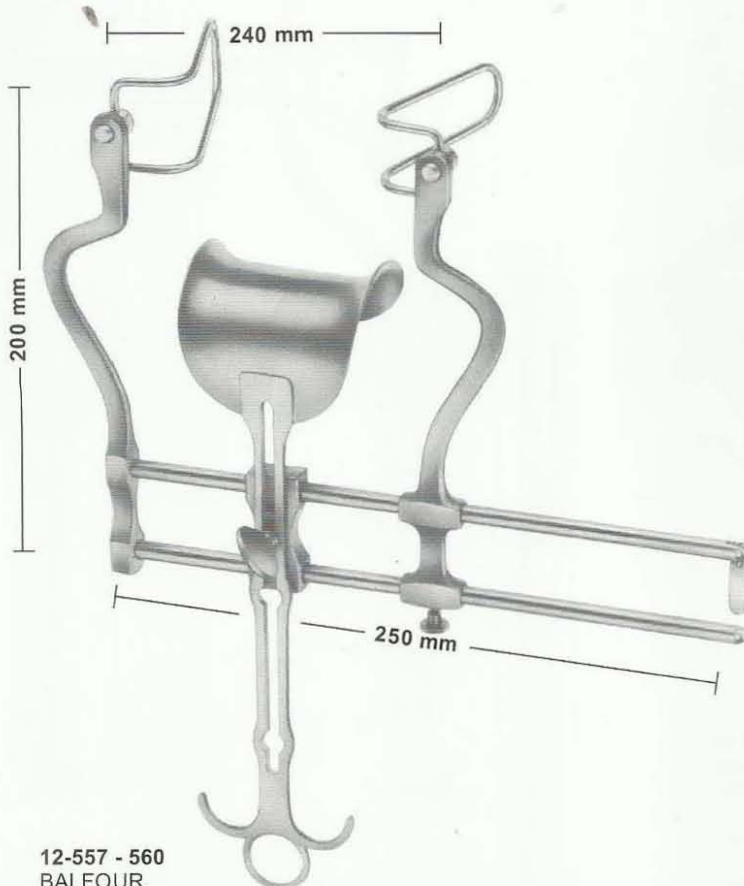

12-557 - 560
BALFOUR
Spreader only 12-561 12-562 12-563 12-564
Lateral blades 50 mm 60 mm 75 mm 90 mm
Center blade 47 x 80 mm 62x76 mm 80x80 mm 80x80 mm



Lateral blades
12-565 50 mm deep
12-566 60 mm deep
12-567 75 mm deep
12-568 90 mm deep
Sales Unit of blades: PR = pair

Complete	12.557	12.558	12.559	12.560
Spreader only	12.561	12.562	12.563	12.564
Lateral blades	12.565	12.566	12.567	12.568
	50mm	60mm	75mm	90mm
Center blade	12.569	12.570	12.571	12.572
	47x80mm	62x76mm	80x80mm	80x80mm

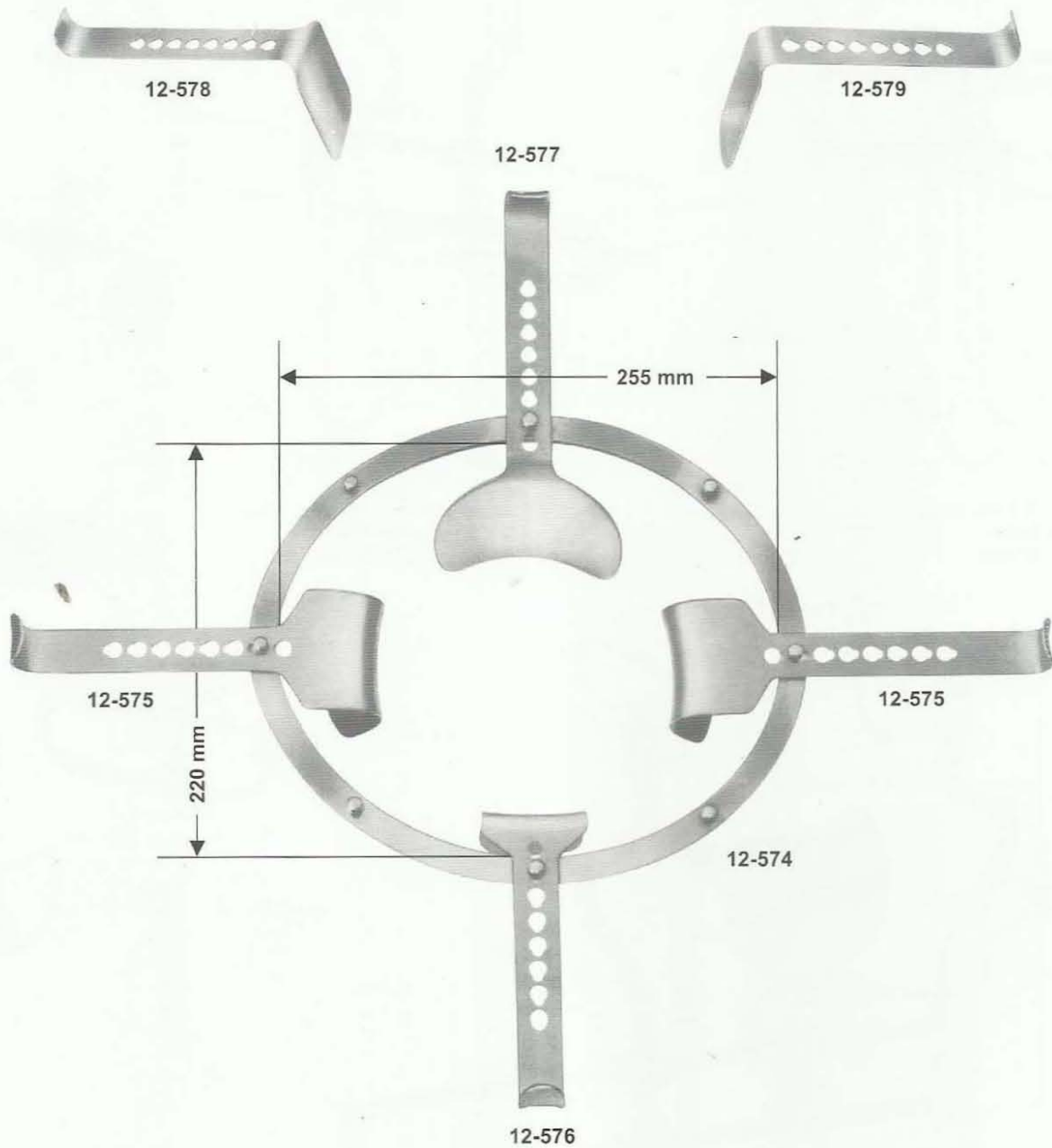

- 12-573
SEMM
consisting of:
- 12-574 1 frame 225 x 220 mm
 - 12-575 2 blades 46 x 64 mm
 - 12-576 1 blade 53 x 54 mm
(for bladder)
 - 12-577 1 blade 82 x 97 mm
(for intestine)
 - 12-578 1 blade 98 x 51 mm
(for intestine)
 - 12-579 1 blade 98 x 51 mm
(for intestine)

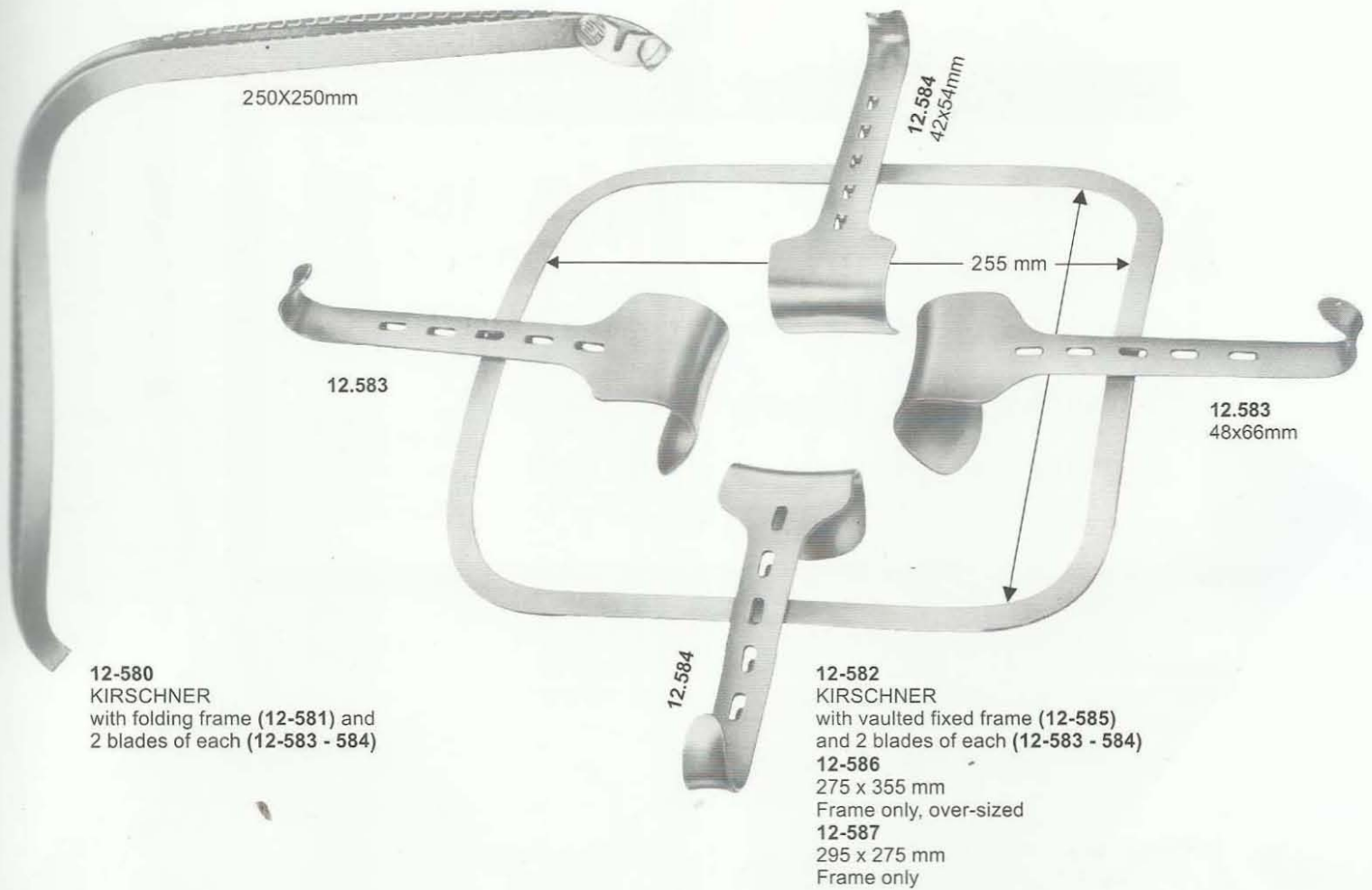

12-580
KIRSCHNER
with folding frame (12-581) and
2 blades of each (12-583 - 584)

12-582
KIRSCHNER
with vaulted fixed frame (12-585)
and 2 blades of each (12-583 - 584)
12-586
275 x 355 mm
Frame only, over-sized
12-587
295 x 275 mm
Frame only

Addition valves for corpulent persons.



12-588
KIRSCHNER
64 x 80 mm

12-589
KIRSCHNER-BALFOUR
80x 82 mm

12-590 - 592
KIRSCHNER
12-590 90x 69mm
12-591 92x 95mm
12-592 78x 58mm

12-593 - 595
KIRSCHNER
12-593 108x42mm
12-594 91x 55mm
12-595 121x 55mm

	SECTION	PAGE
Forceps, Intestinal Clamps	13	168-186
Biopsy Forceps	14	187-203
Blader Retractor, Trocars & Urinary Instruments	15	204-208



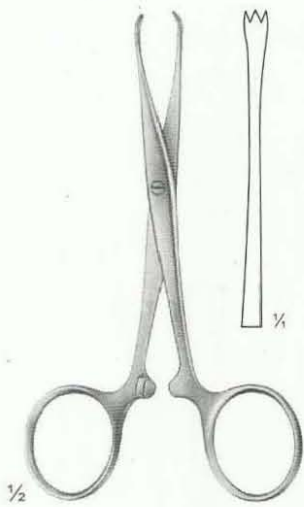

13-101
CHAPUT
 2 X 3 teeth, sharp
 125 mm,

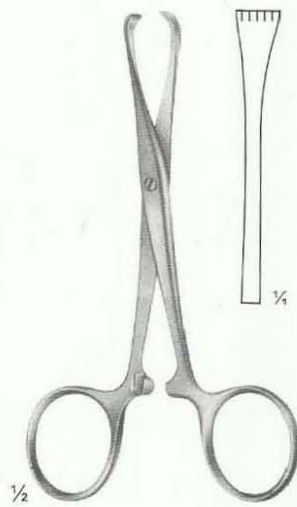

13-102
TUFFIER
 5 X 6 teeth, sharp
 125 mm,

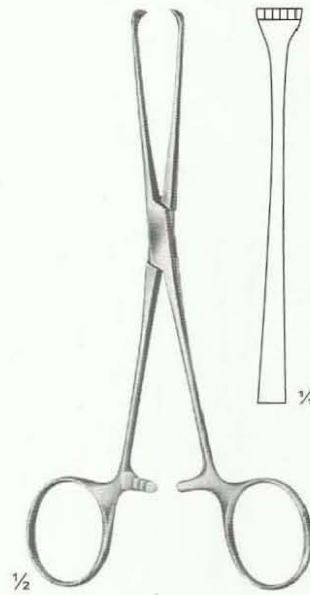

13-103
BOYS-ALLIS
 5 X 6 teeth, sharp
 155 mm,

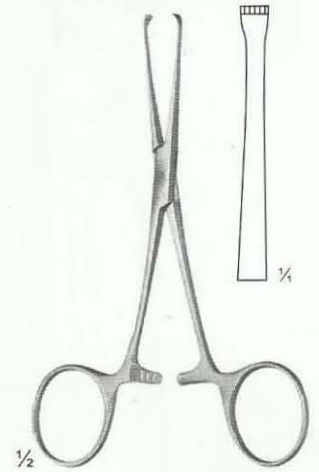

13-104
BABY-ALLIS
 4 X 5 teeth
 130mm

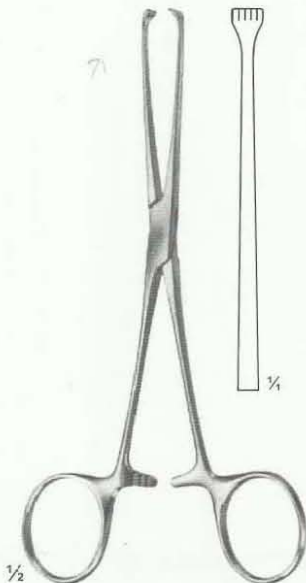

13-105
ALLIS
 4 X 5 teeth
 155 mm,

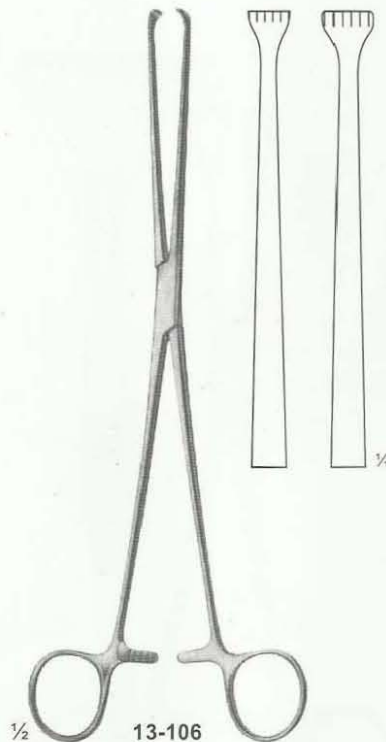

13-106
ALLIS
 190 mm,
13-107
 255 mm,
 5 X 6 teeth
 Slender pattern

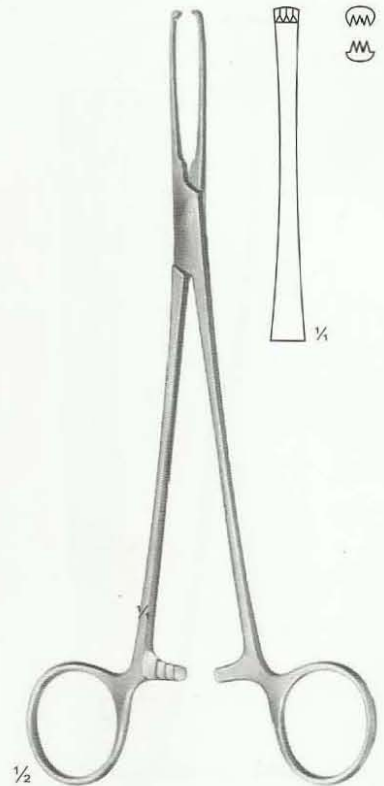

13-108
JUDD-ALLIS
 3 X 4 teeth
 195 mm,

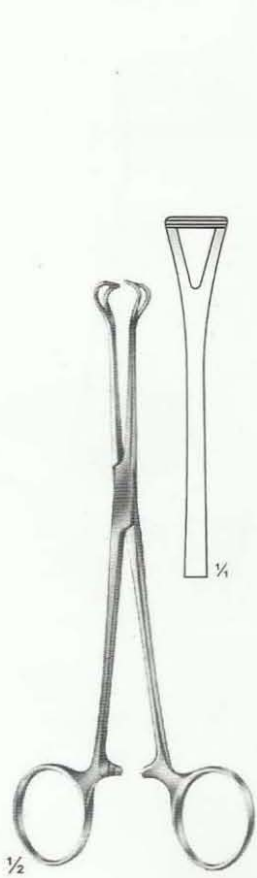

13-109
BABCOCK
155 mm

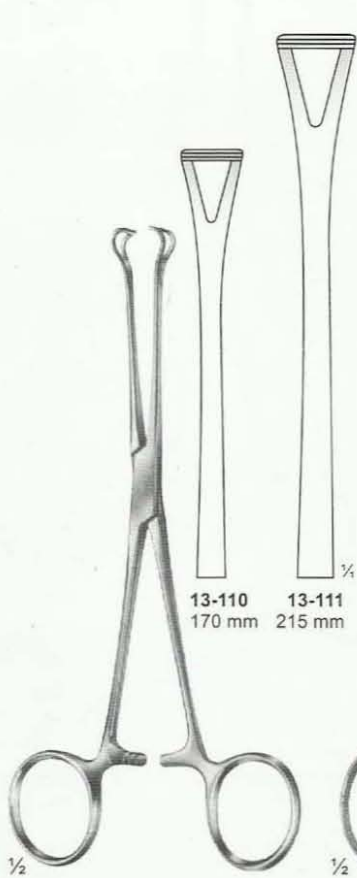

13-110 170 mm
13-111 215 mm

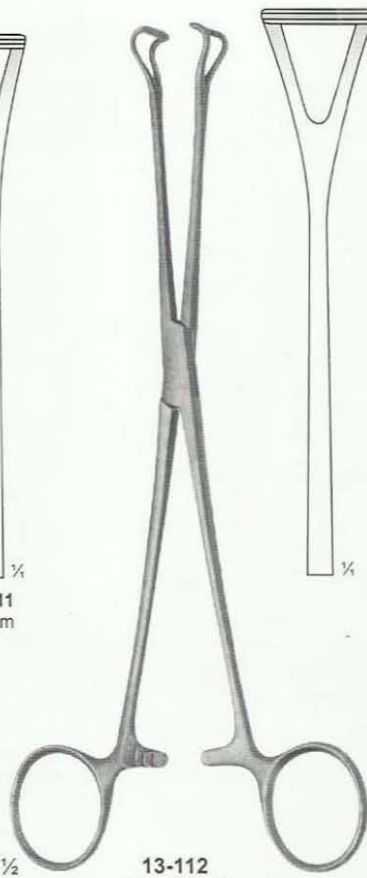

13-112
BABCOCK
220 mm

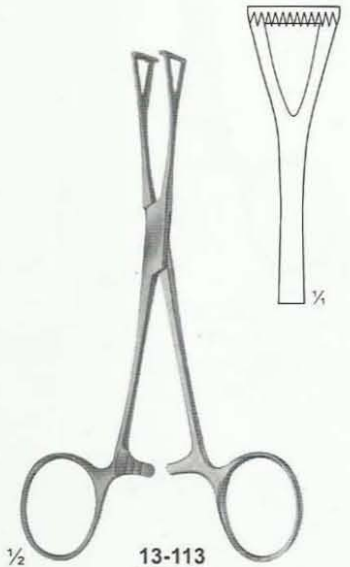

13-113
COLLIN
140 mm,

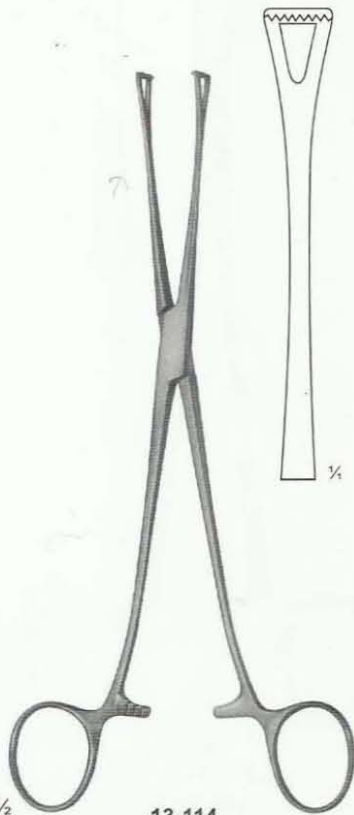

13-114
LOCKWOOD
200 mm.

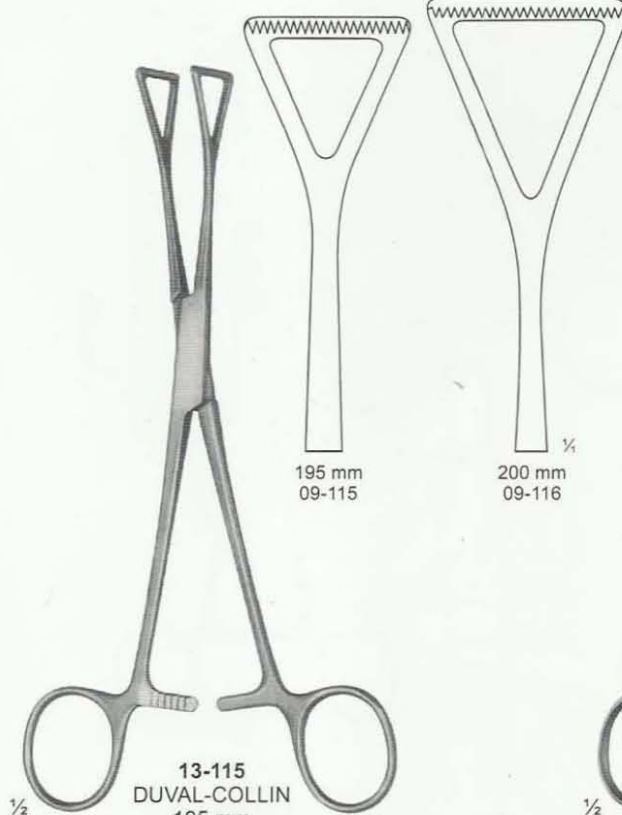

13-115
DUVAL-COLLIN
195 mm
13-116
200 mm

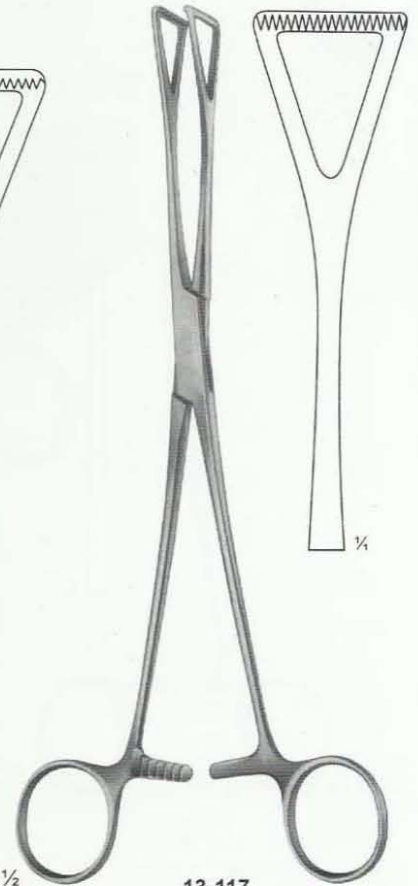

13-117
DUVAL
230 mm.

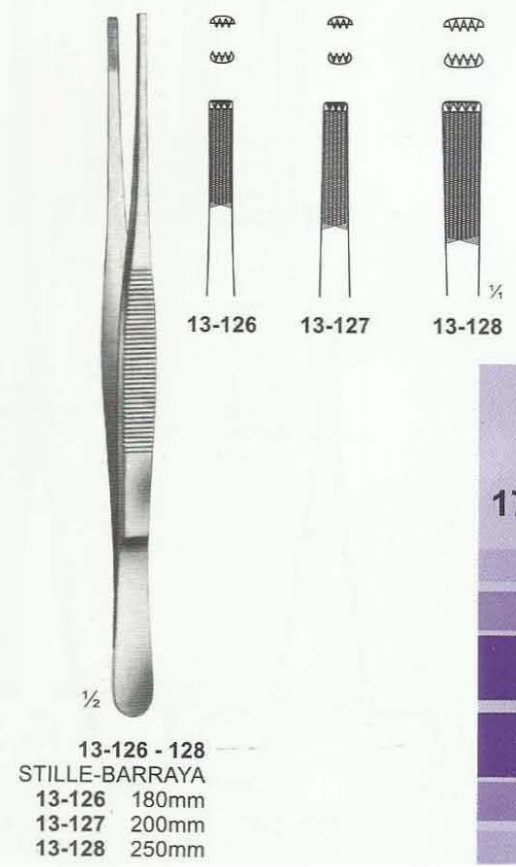
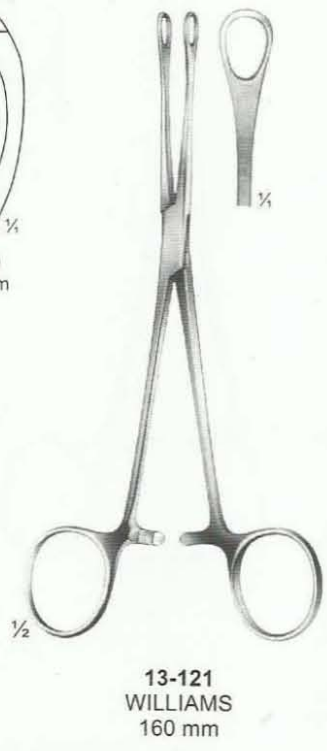
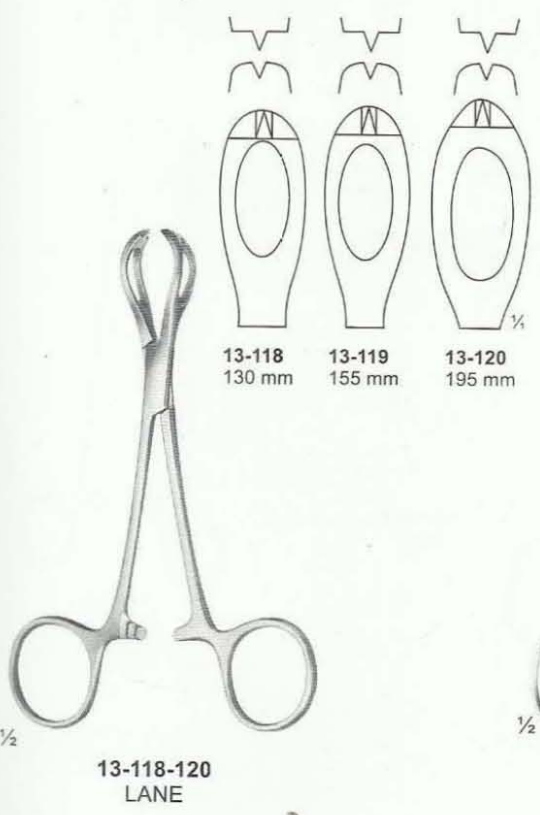

Organ - Tissue Grasping & Intestinal
Forceps Atraumata

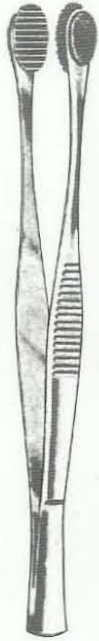

YOUNG
13-129A
21 cm / 8 1/4"

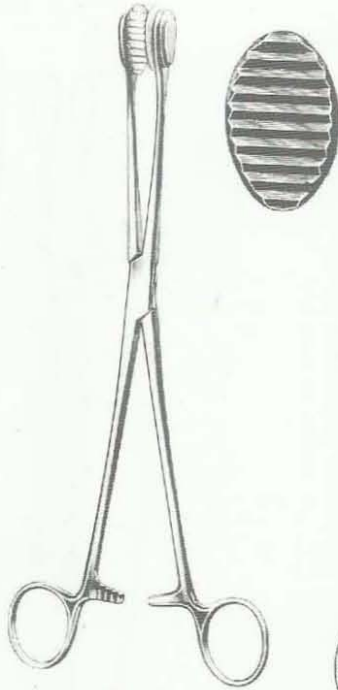

CHILD
13-129B
24 cm / 9 1/2"

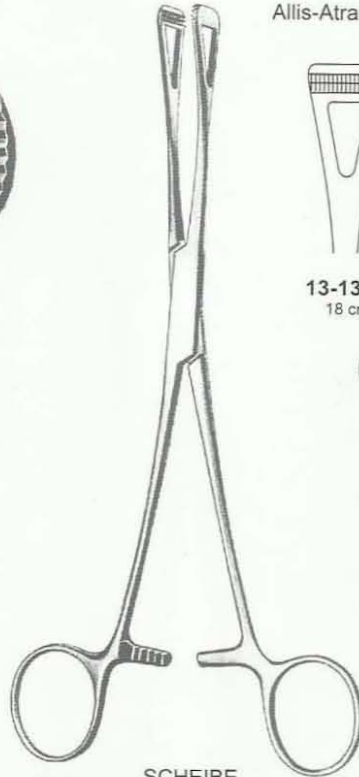

SCHEIBE

Allis-Atrauma



13-134A
18 cm



13-134B
20 cm



13-134C
23 cm

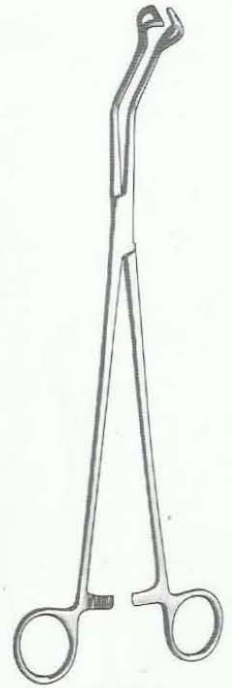

13-135A
BABCOCK
Angled 45°

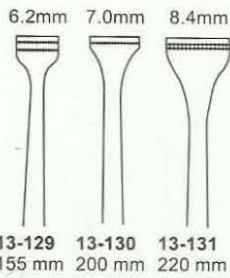

13-129 155 mm
13-130 200 mm
13-131 220 mm

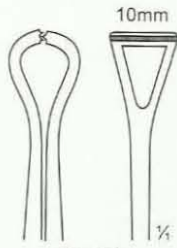

13-134
160 mm

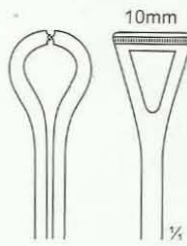

13-135
215 mm

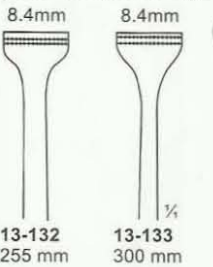

13-132
255 mm

13-133
300 mm



13-129 - 133
ALLIS

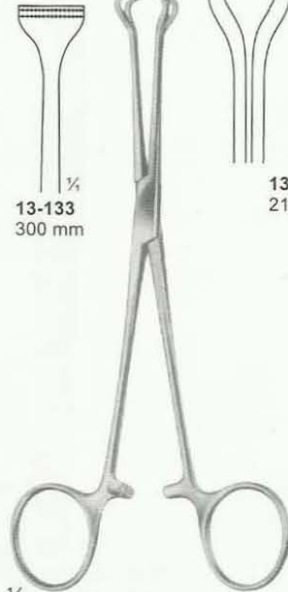

13-134 - 135
BABCOCK

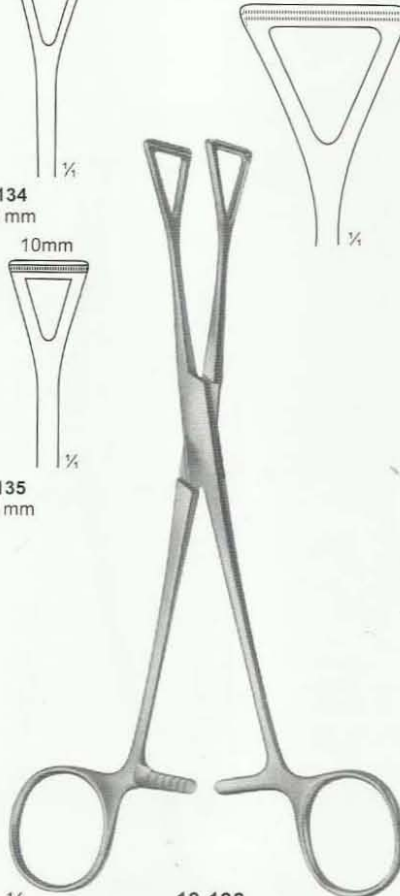

13-136
COLLIN
195 mm

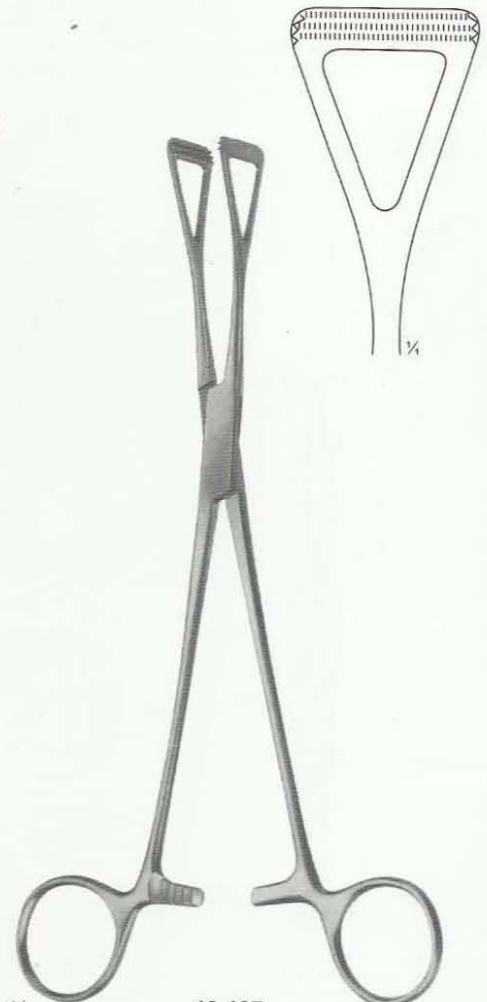

13-137
COLLIN
230 mm

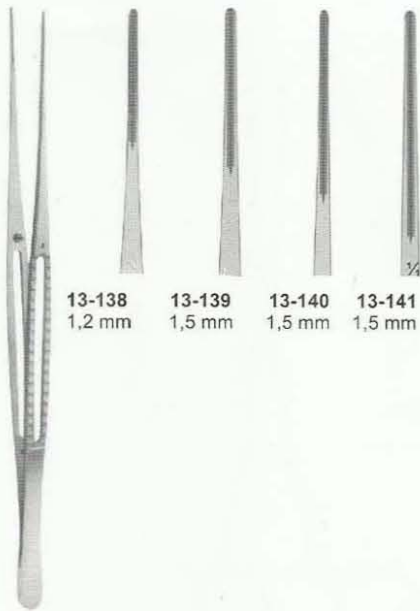

13-138 1,2 mm
13-139 1,5 mm
13-140 1,5 mm
13-141 1,5 mm

- 13-138 - 141
13-138 150 mm
13-139 200 mm
13-140 240 mm
13-141 300 mm

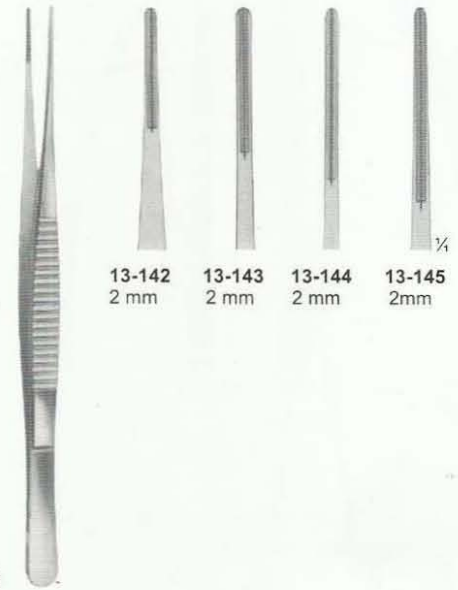

13-142 2 mm
13-143 2 mm
13-144 2 mm
13-145 2mm

- 13-142 - 145
DE BAKEY
13-142 150 mm
13-143 200 mm
13-144 240 mm
13-145 300 mm

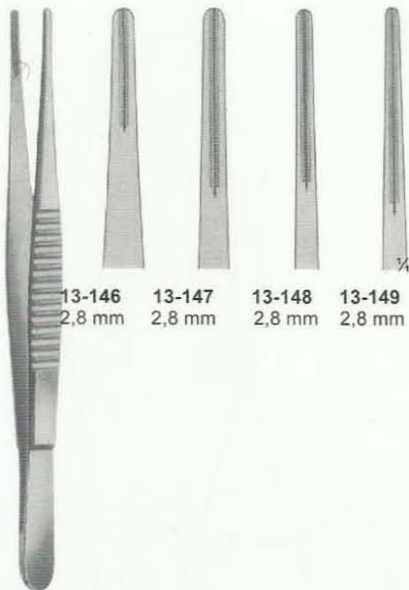

13-146 2,8 mm
13-147 2,8 mm
13-148 2,8 mm
13-149 2,8 mm

- 13-146 - 149
DE BAKEY
13-146 150 mm
13-147 200 mm
13-148 240 mm
13-149 300 mm

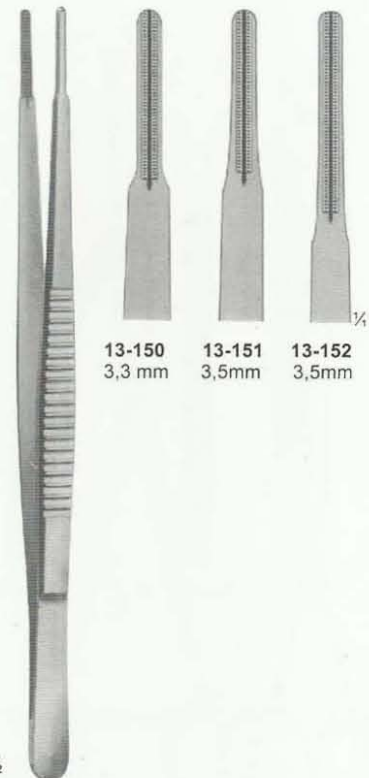

13-150 3,3 mm
13-151 3,5mm
13-152 3,5mm

- 13-150 - 152
DE BAKEY
13-150 200 mm
13-151 240 mm
13-152 300 mm

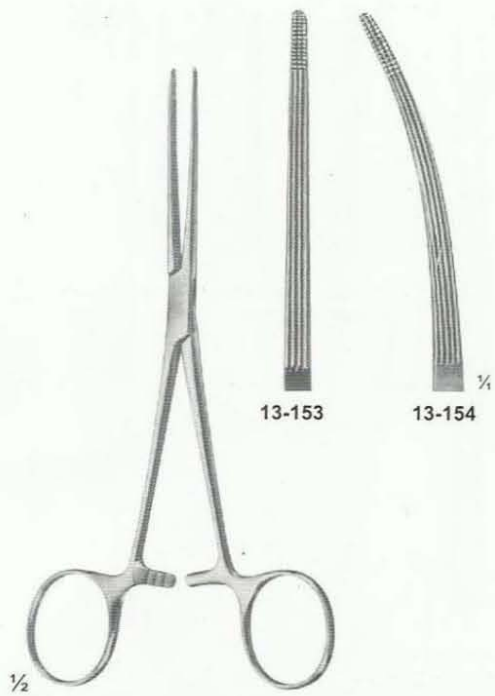

13-153 - 154
BAINBRIDGE
155 mm

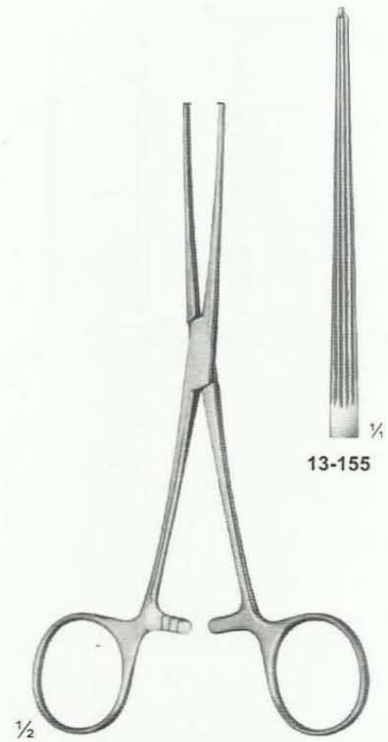

13-155
ALLEN
155 mm

Atraumata



13-156 - 157
BABY-KOCHER

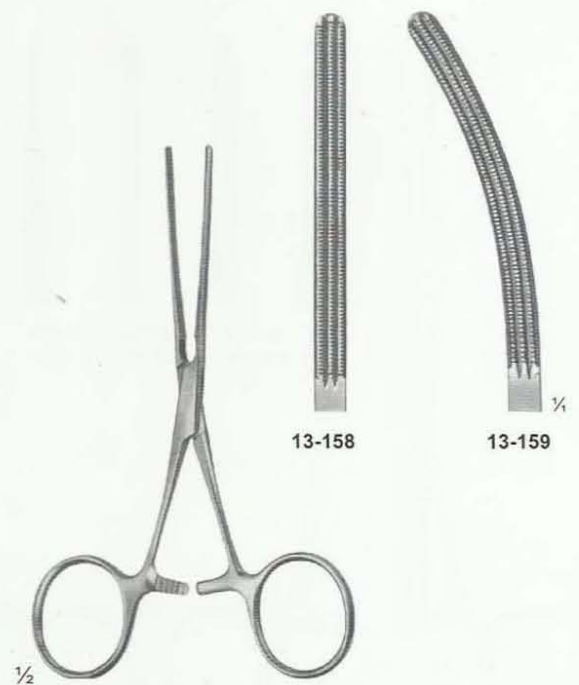

13-158 - 159
BABY-KOCHER
with locking device

Atraumata

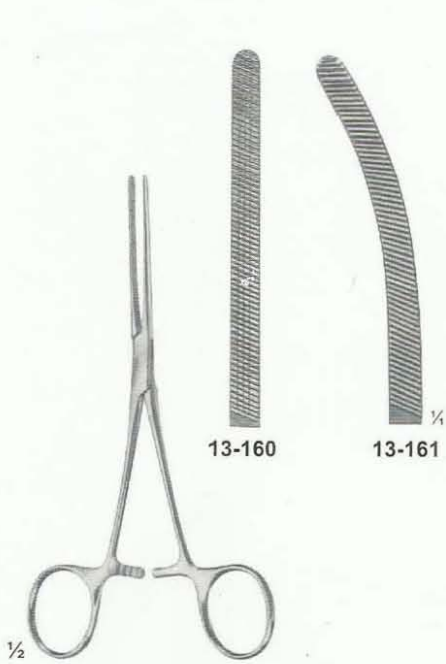

13-160 - 161
DOYEN
elastic
165 mm



13-162 - 163
DOYEN
with elastic blades
170 mm

Atraumata



13-164 - 165
HARTMANN
with elastic blades
200 mm



13-166 - 167
HARTMANN
with elastic blades
200 mm

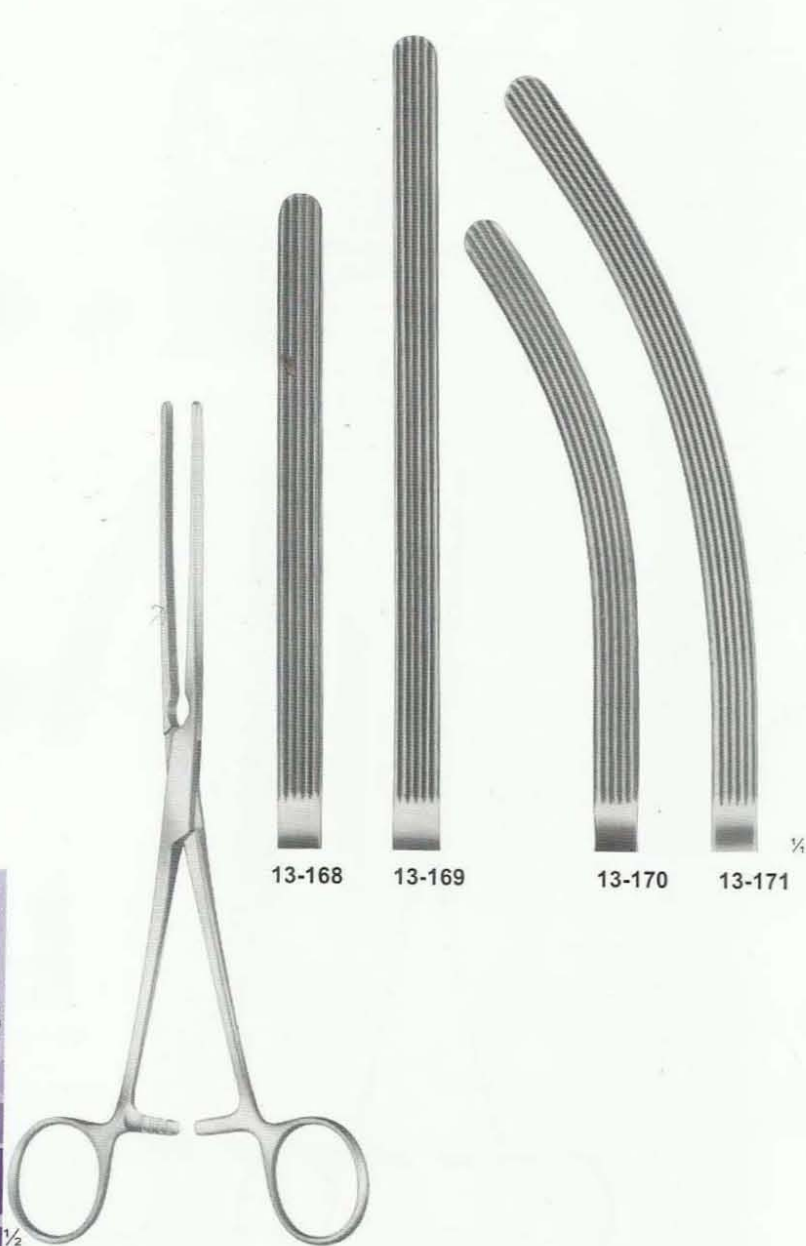

13-168 13-169 13-170 13-171

13-168 - 171
KOCHER
with elastic blades
13-168 13-170 210 mm

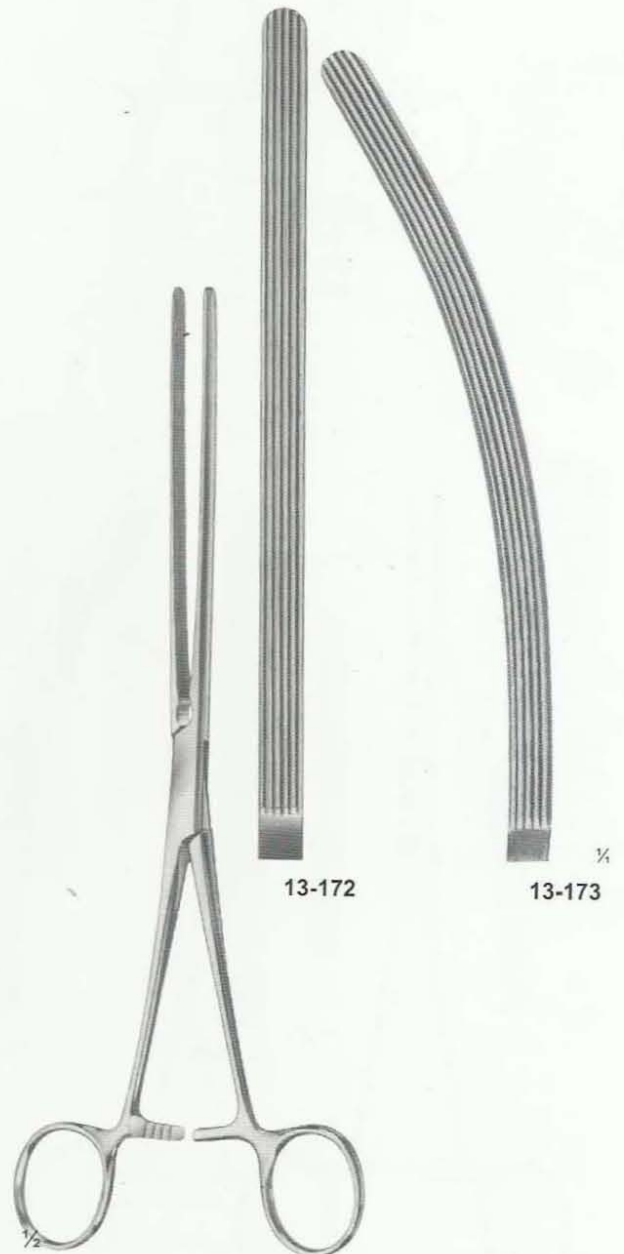

13-172 13-173

13-172 - 173
DOYEN
with elastic blades
210 mm

Atraumata



13-174

13-175

13-174 - 175
DOYEN
with elastic blades
235 mm

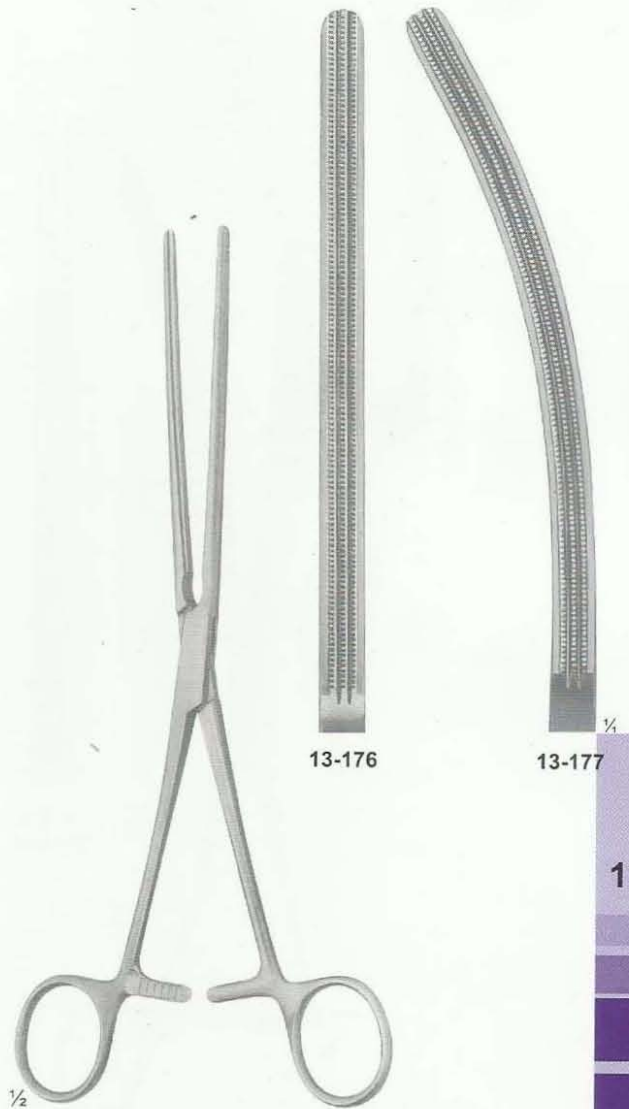

13-176

13-177

13-176 - 177
DOYEN
with elastic blades
230 mm



1/2

13-178 - 183
KOCHER

with non-elastic blades



13-178 220 mm
13-179 250 mm
13-180 280 mm

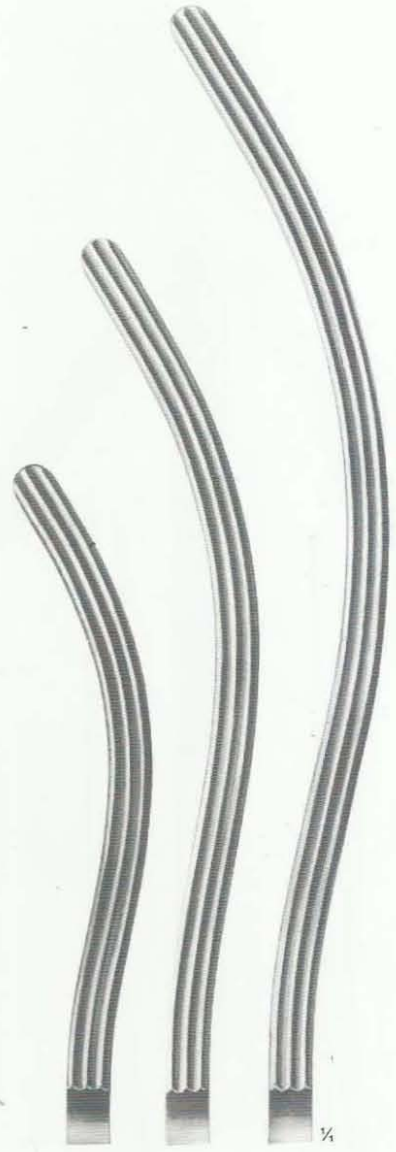

13-181 220 mm
13-182 250 mm
13-183 280 mm

Atraumata

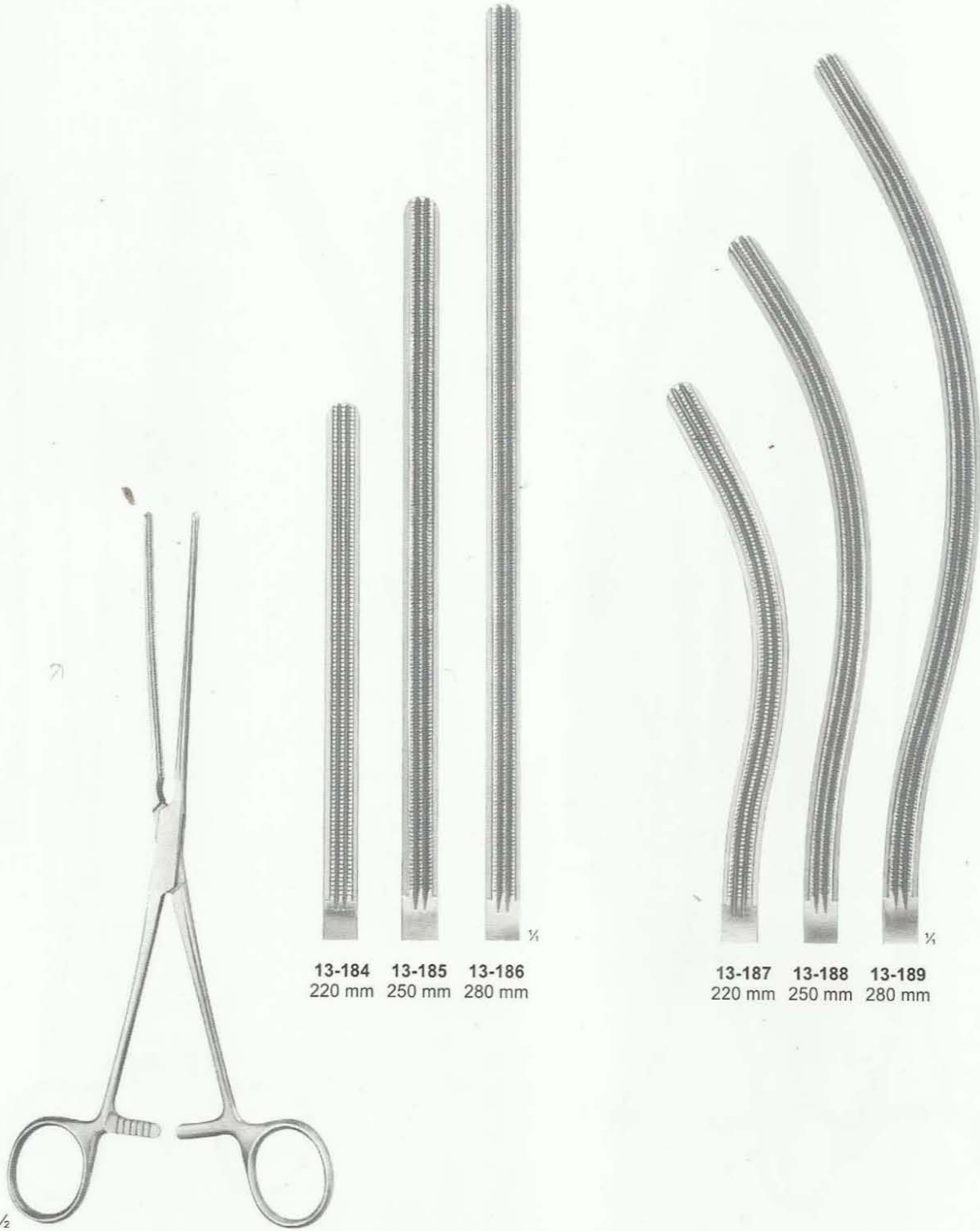

13-184 220 mm
13-185 250 mm
13-186 280 mm

13-187 220 mm
13-188 250 mm
13-189 280 mm

1/2

13-184 - 189
KOCHER
with very elastic blades

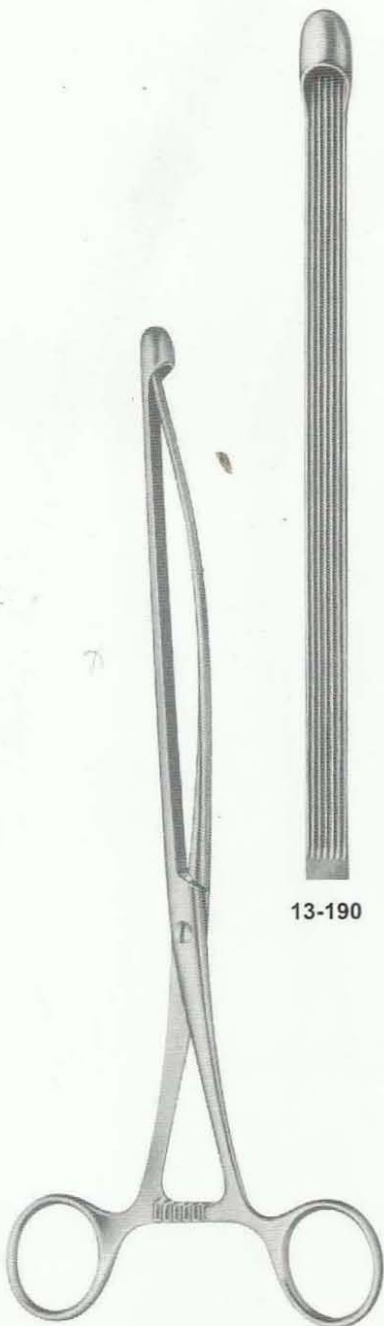

13-190

13-191

13-190 - 191
NUSSBAUM
with elastic blades
250 mm

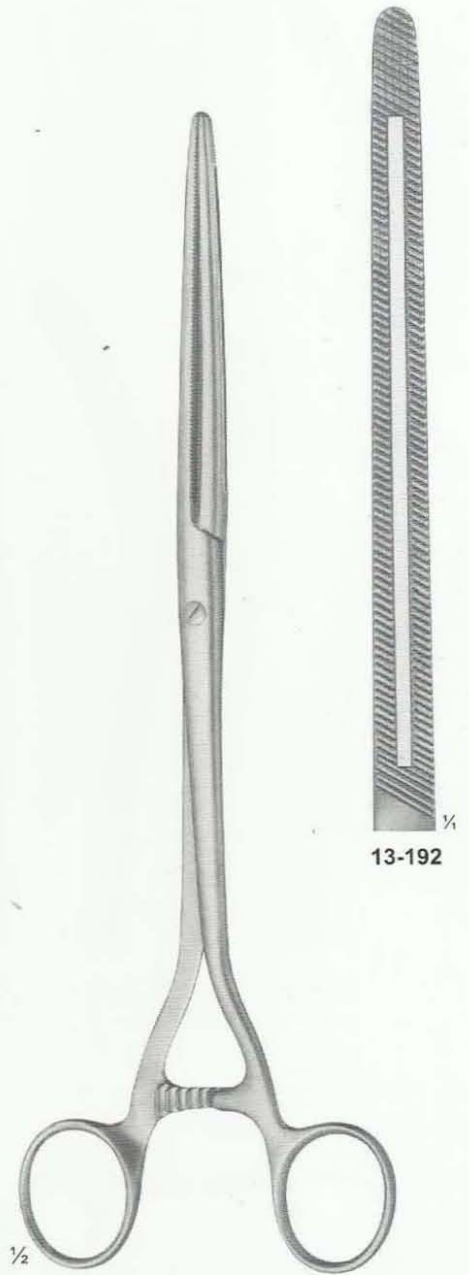
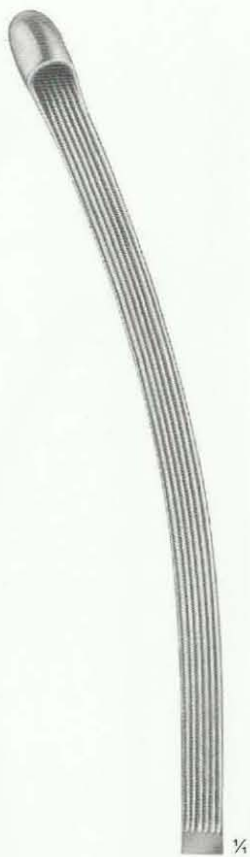

13-192

13-192
MOYNIHAN
280 mm

Atraumata

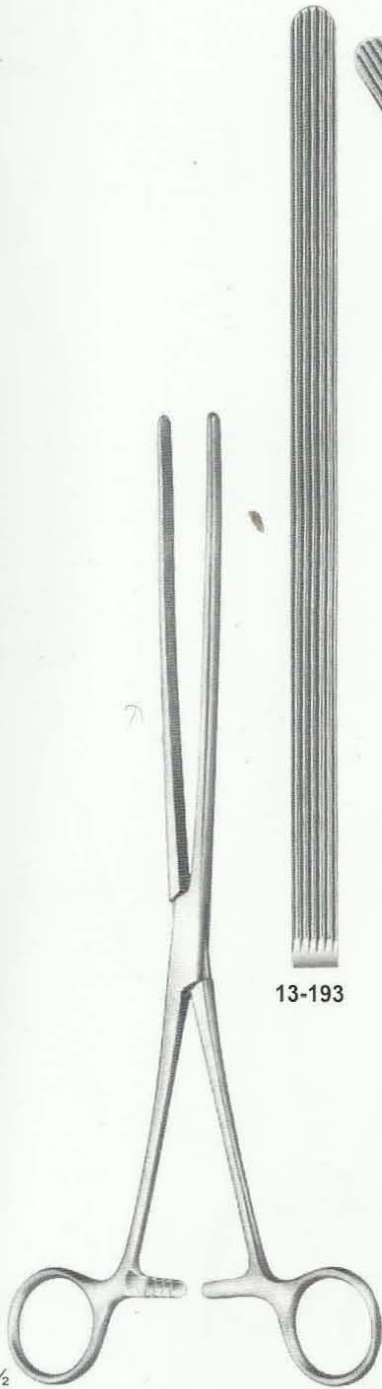

13-193

13-194

13-193 - 194
MAYO-ROBSON
hard elastic
250 mm

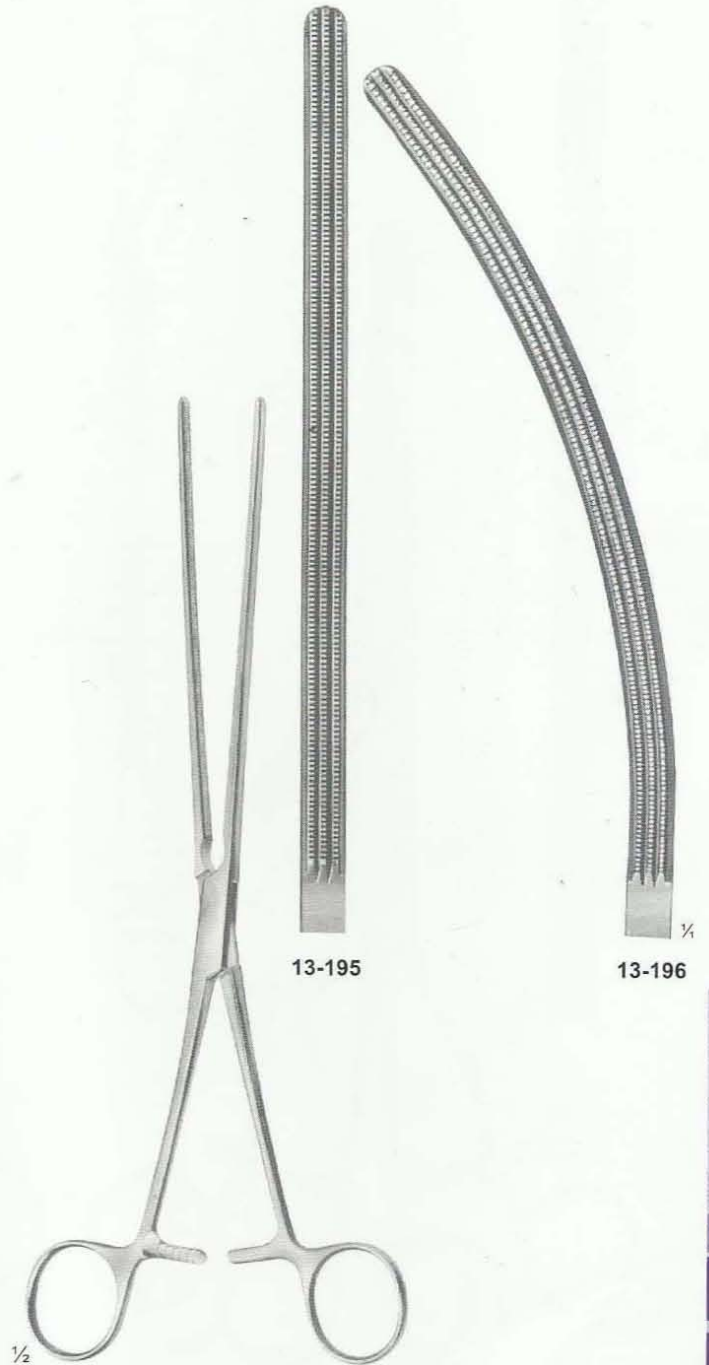

13-195

13-196

13-195 - 196
MAYO-ROBSON
250 mm



13-197
LANE

13-198
LANE

Atraumata

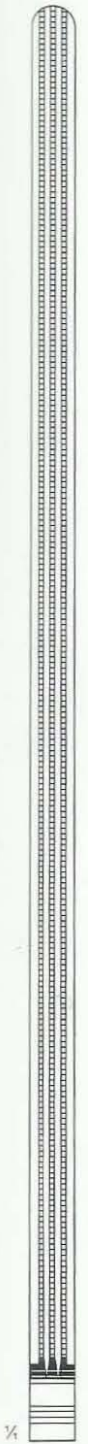

13-199

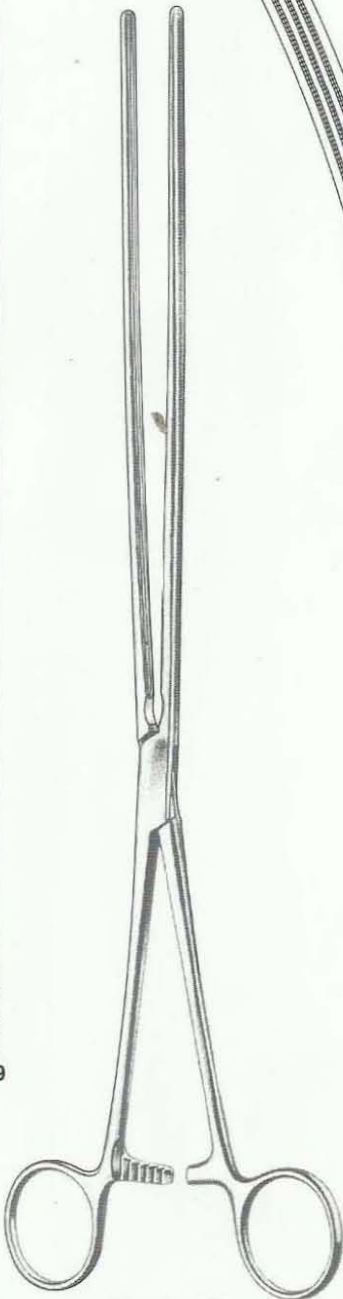

13-199 - 200
SCUDDER
330 mm

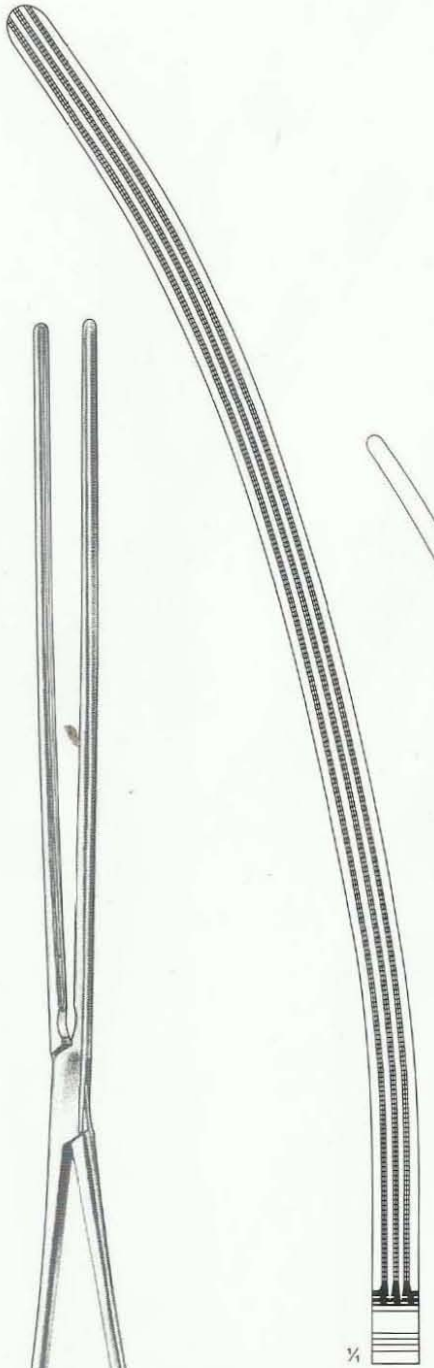

13-200



13-201
KLEINSCHMIDT
Spur crushers and
Appendectomy clamps
130 mm

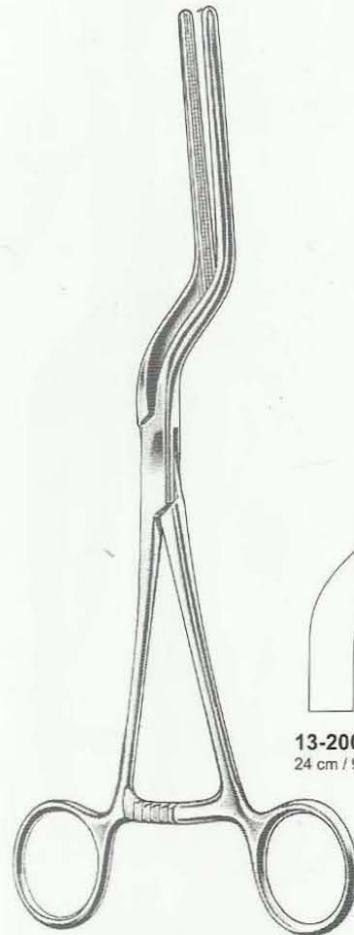

13-200A
24 cm / 9 1/2"

BRUNNER



13-202
PAYR
Intestinal clamp
light pattern,
for children

13-203
PAYR
200 mm

13-204
PAYR
275 mm

13-205
PAYR
Pylorus clamp
315 mm

Atraumata

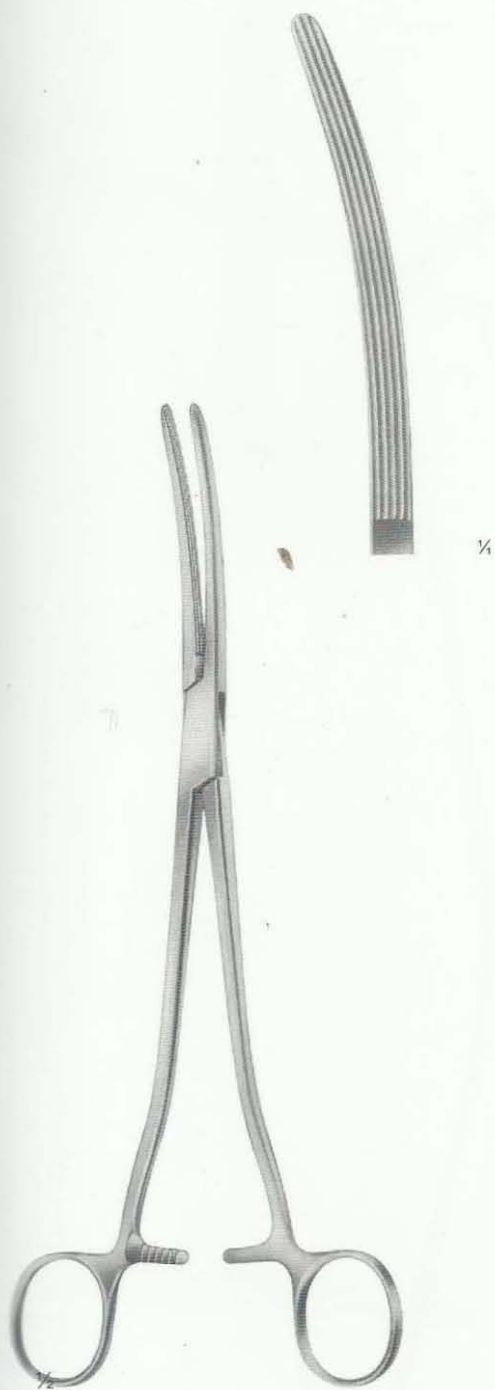

13-206
PARKER-KERR
anastomosis forceps
for colon resection
250 mm



13-207
255 mm 13-208
265 mm 13-209
275 mm



13-207 - 209
DICK
pressure clamps

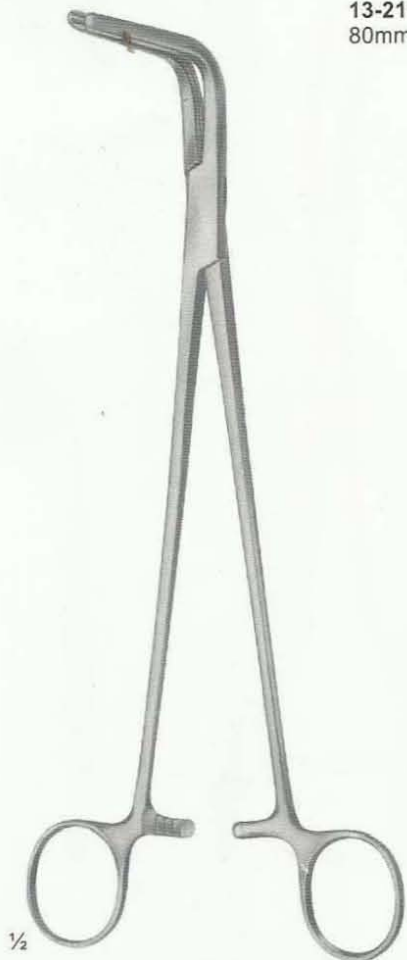
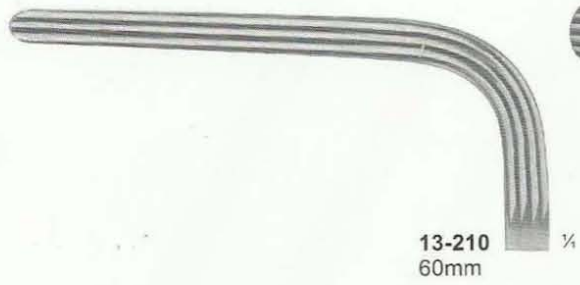

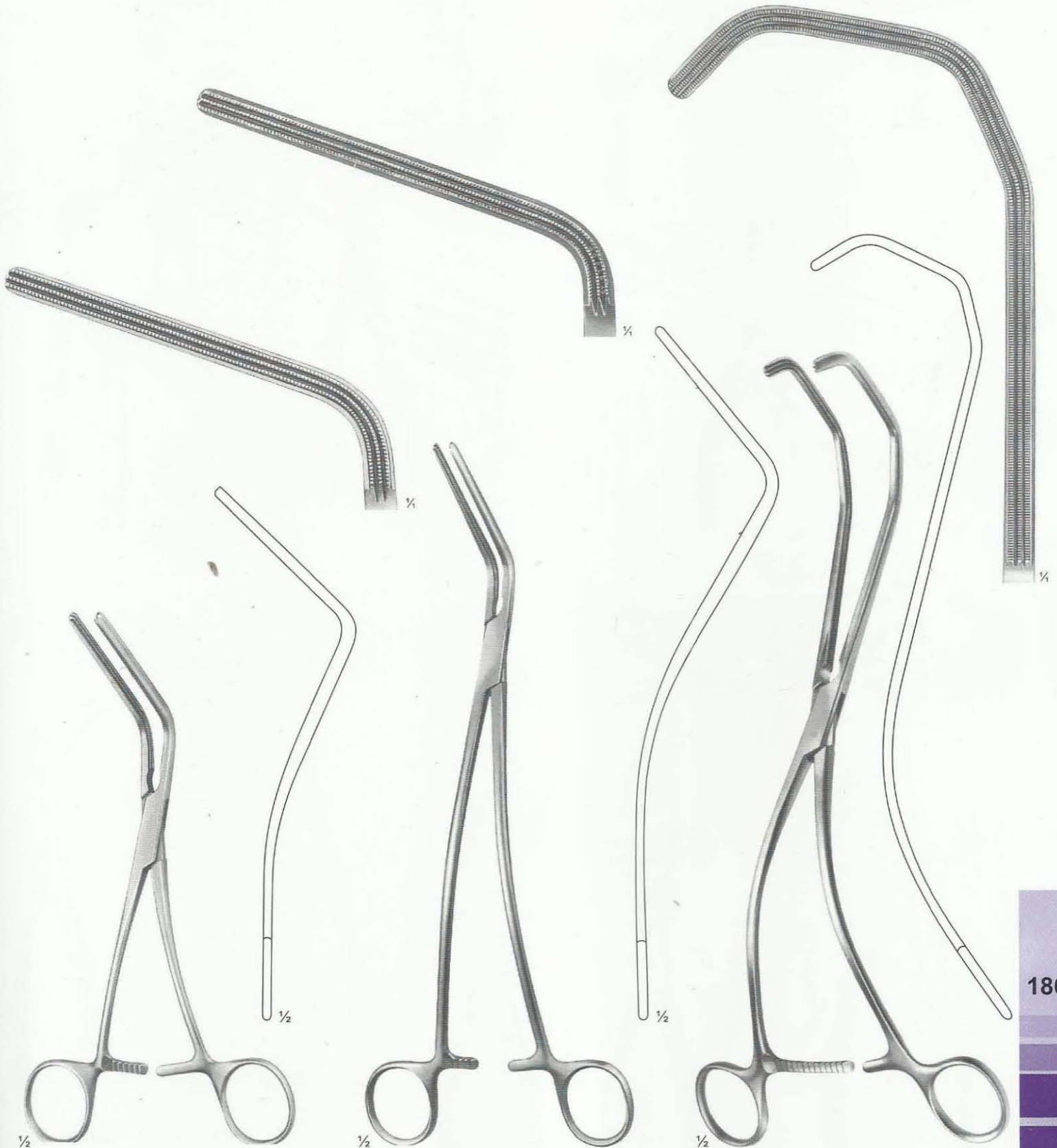

13-213
MORRIS
175 mm

13-214
DE BAKEY
(MORRIS modif.)
240 mm

13-215
KERSTING
270 mm

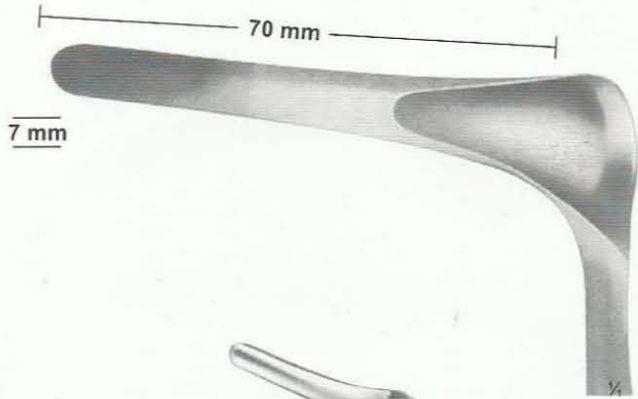

14-101
KILLIAN
for children
145 mm



14-102
SIMS
160 mm

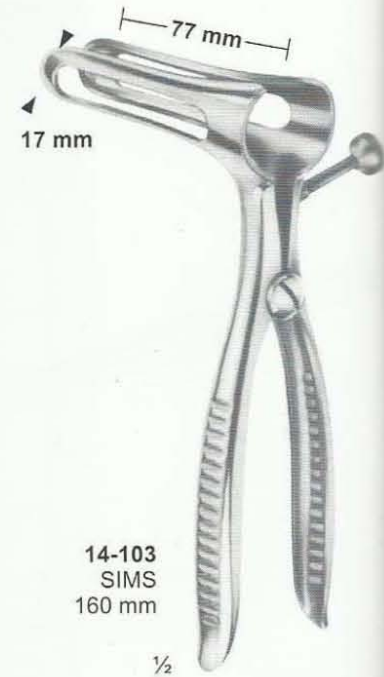

14-103
SIMS
160 mm

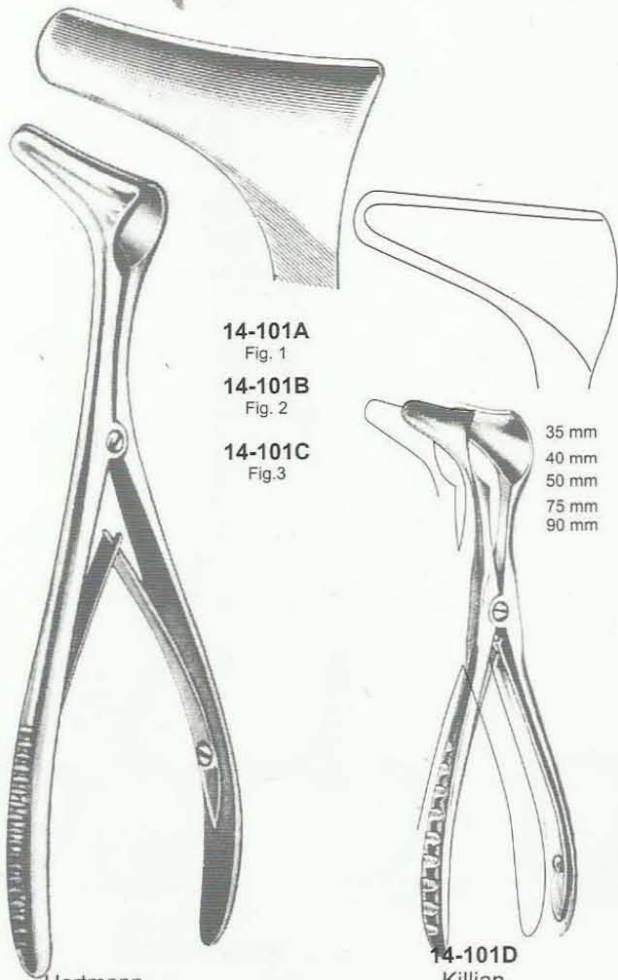

14-101A
Fig. 1
14-101B
Fig. 2
14-101C
Fig. 3

35 mm
40 mm
50 mm
75 mm
90 mm

14-101D
Killian

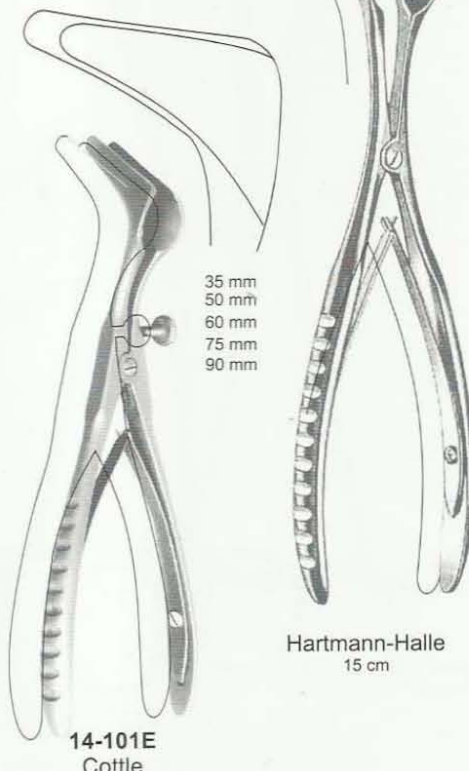

35 mm
50 mm
60 mm
75 mm
90 mm

14-101E
Cottle

Hartmann-Halle
15 cm

14-102A
Fig. 1
14-102B
Fig. 2
14-102C
Fig. 3



Vienna
14-103A Infant
14-103B Child
14-103C Adult
14-103D Shear
14-103E Metal

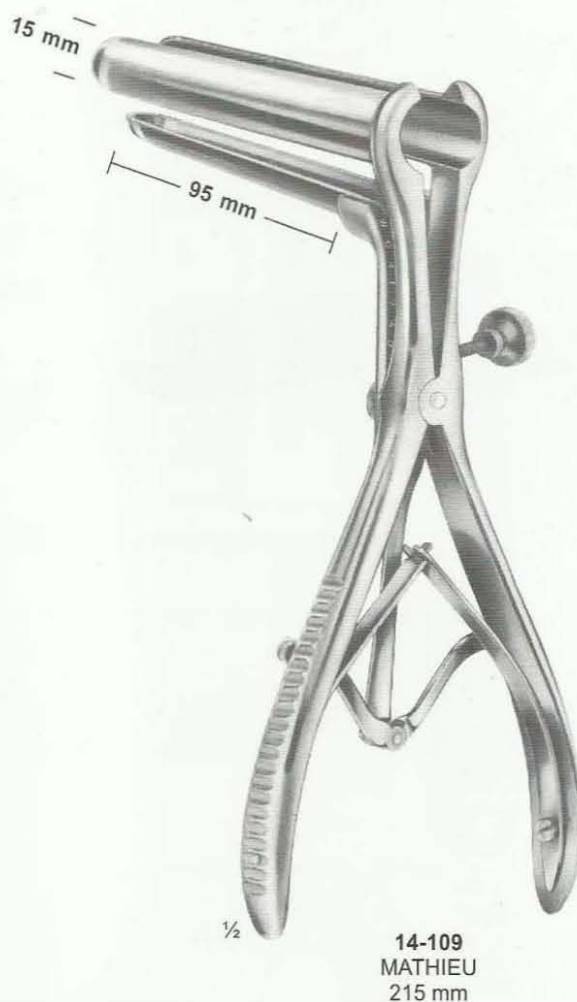
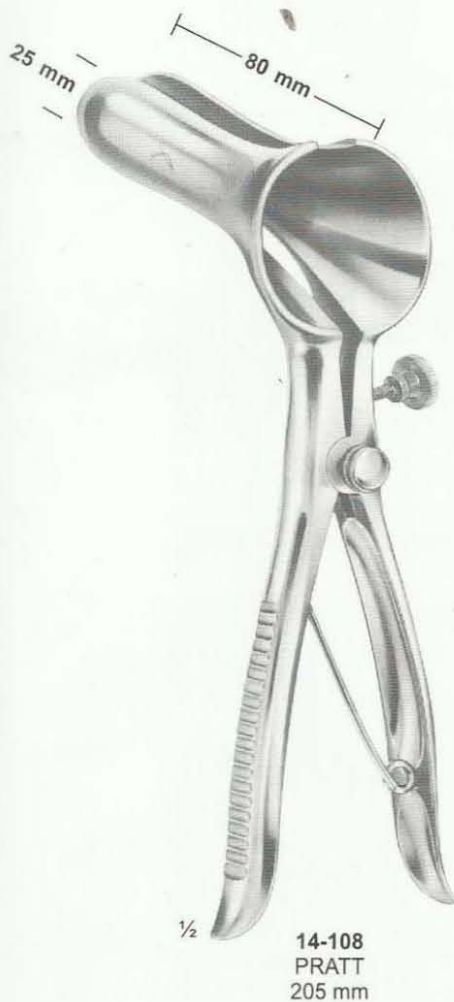
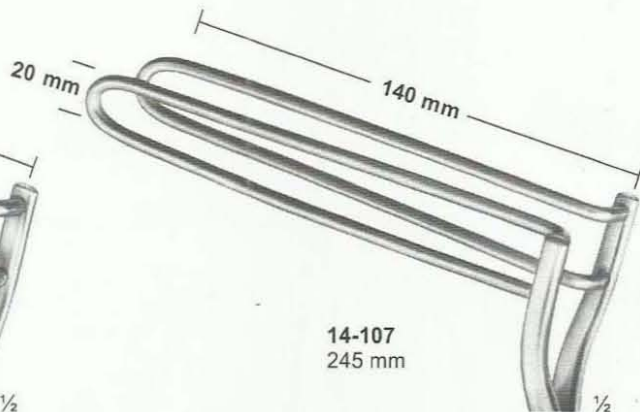
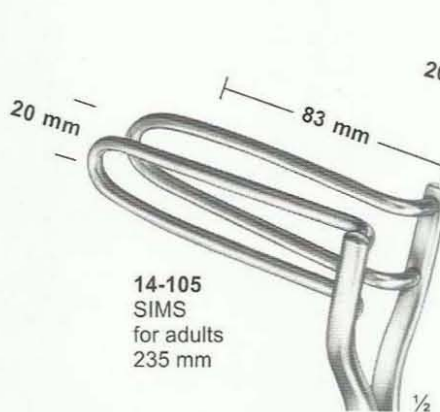
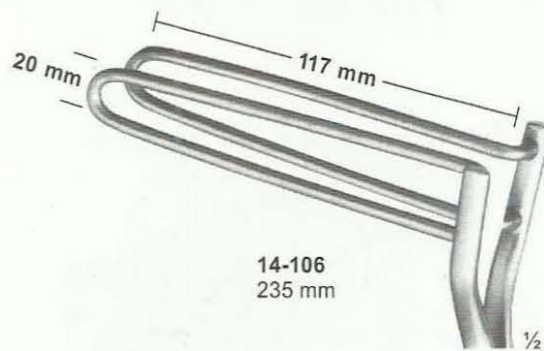
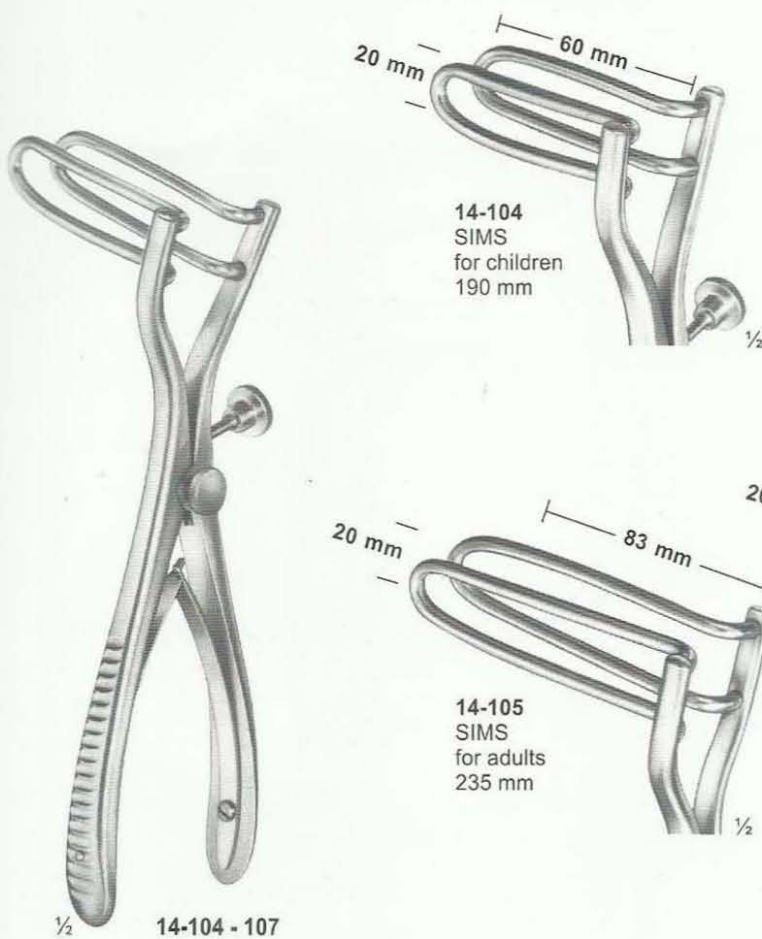

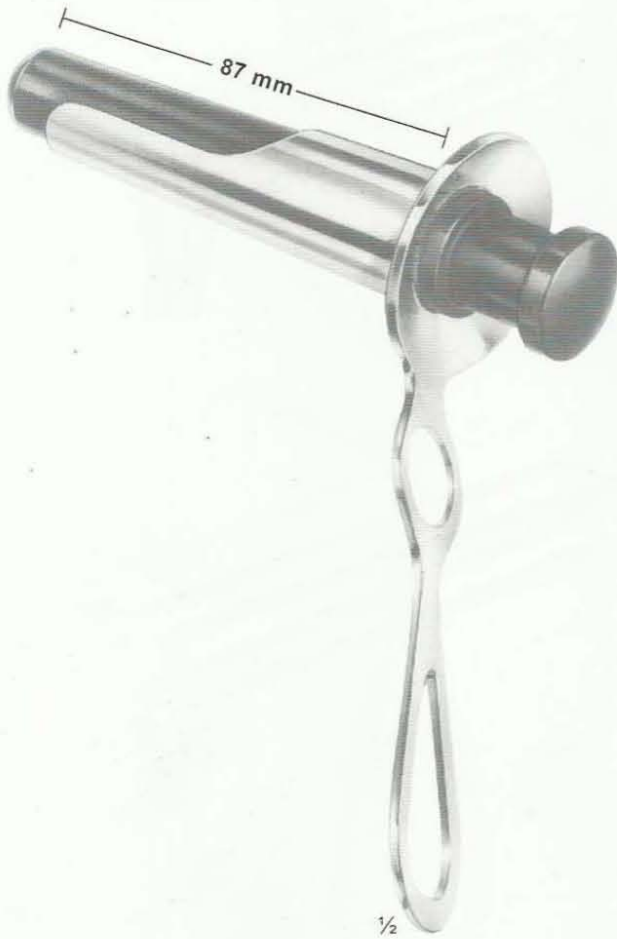

14-110
IVES-FANSLER
Anuscope
145 mm
24mm ϕ

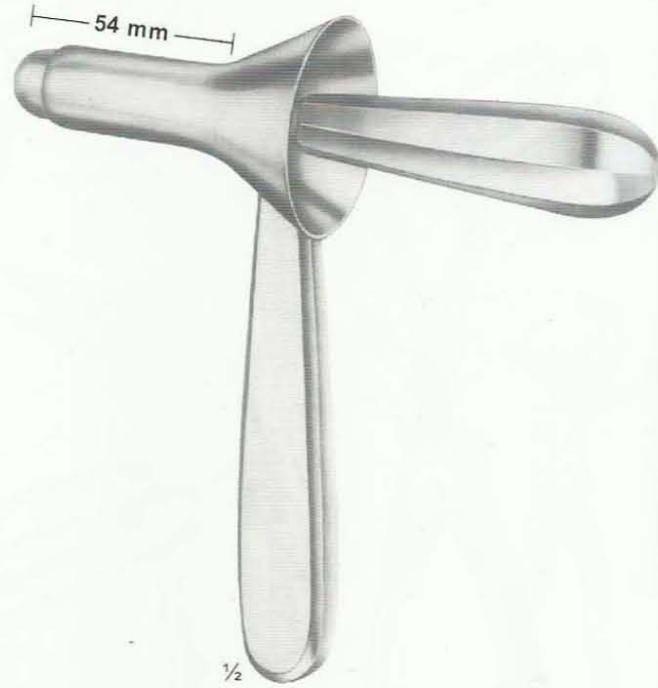

14-111
KELLY
Sphincteroscope
160 mm
21mm ϕ

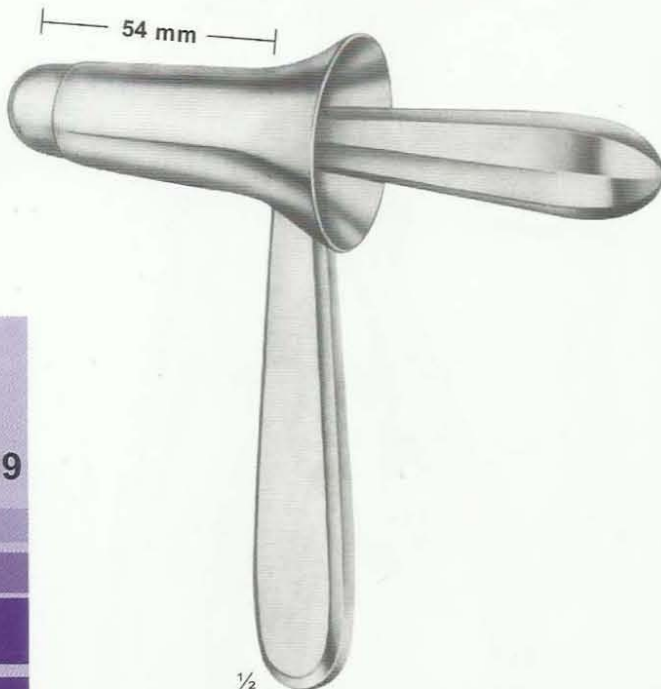

14-112
KELLY
Sphincteroscope
160 mm

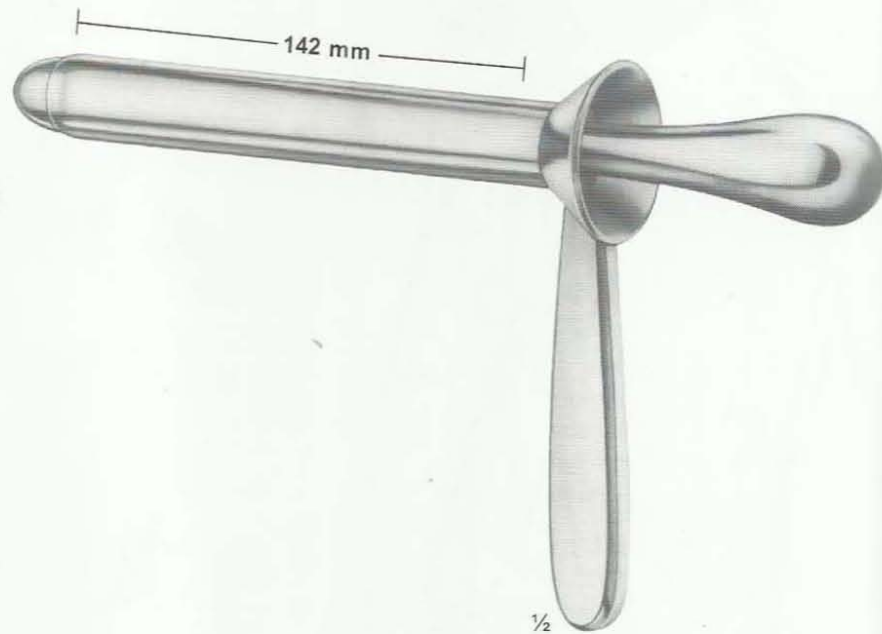

14-113
KELLY
Proctoscope
140 mm
22mm ϕ

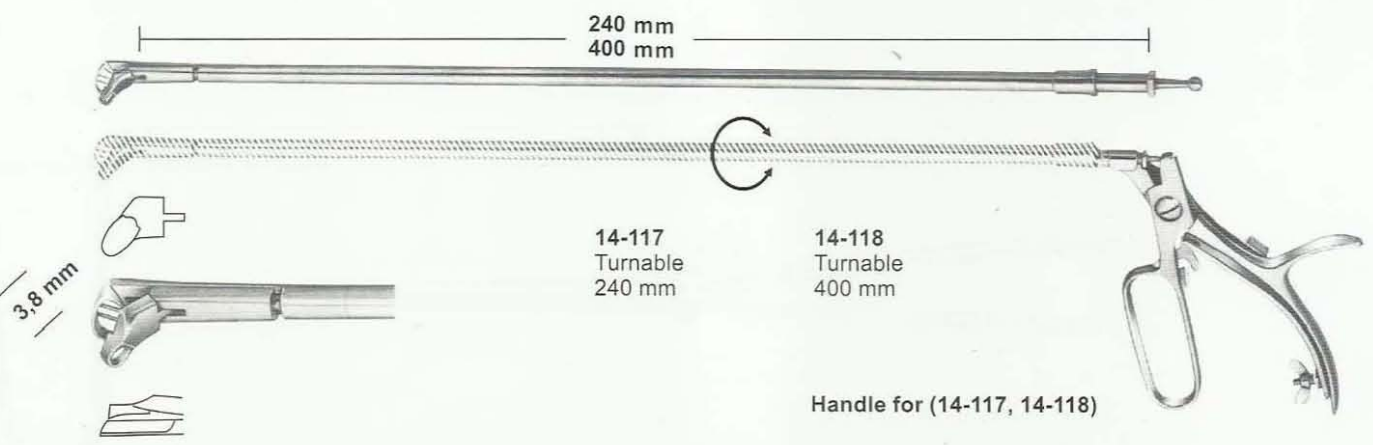
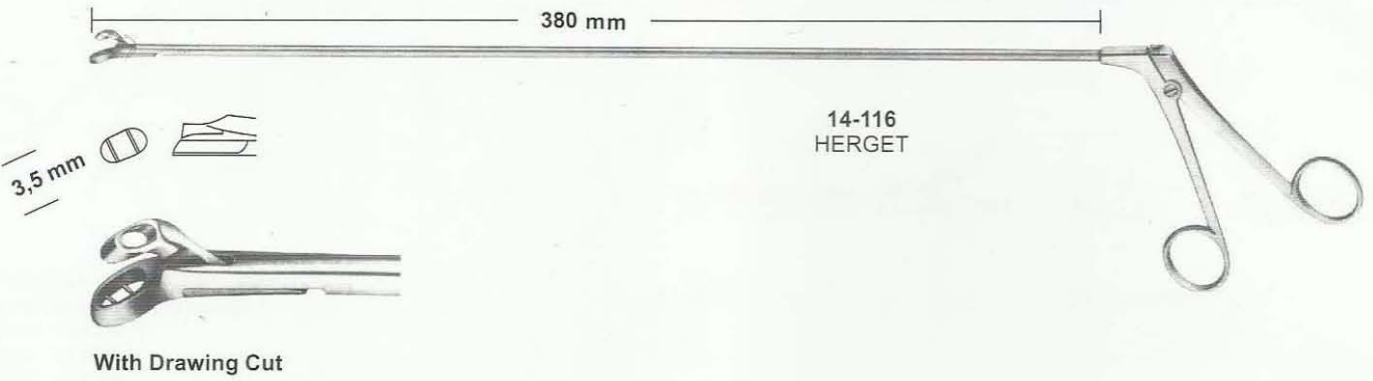
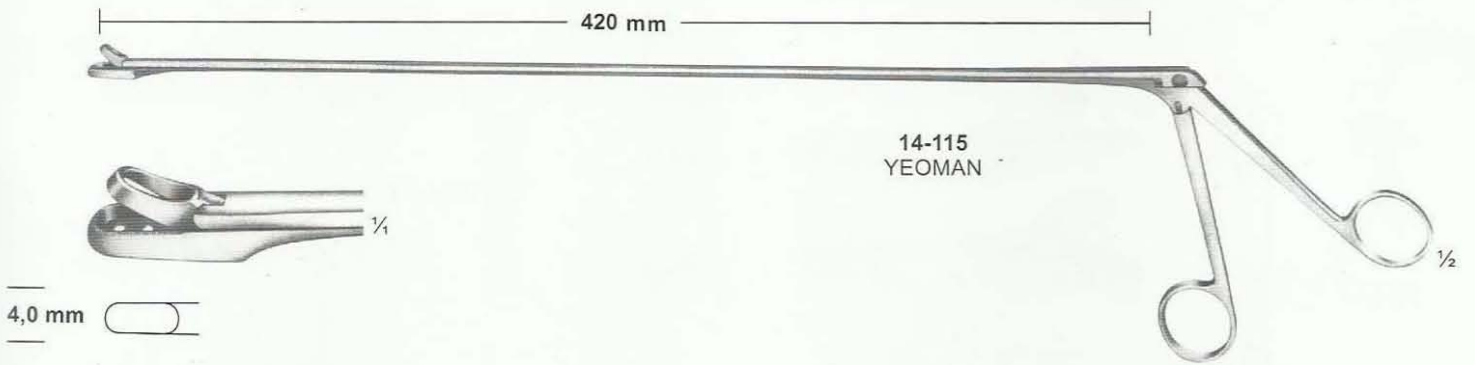
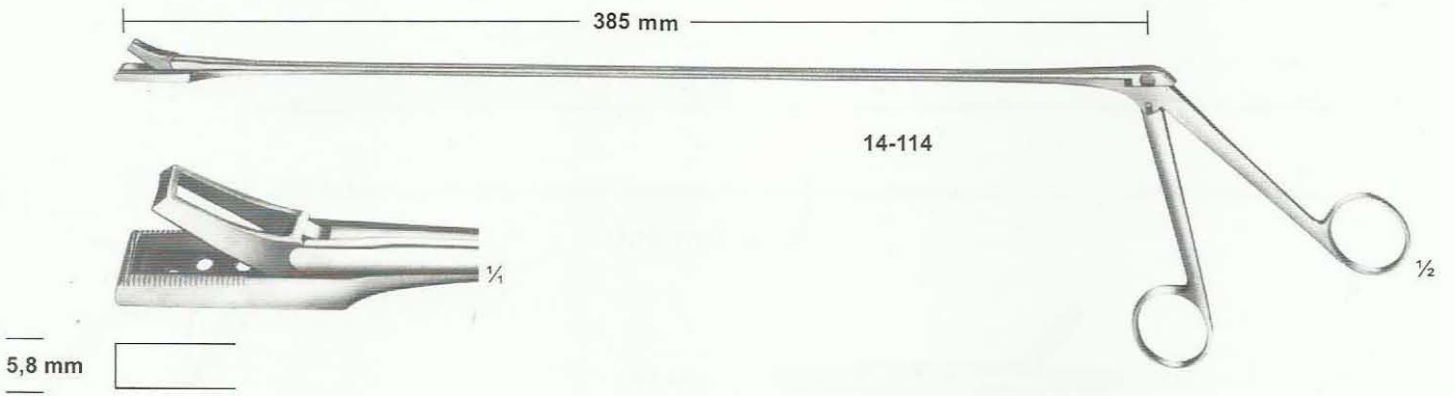

With Drawing Cut,
Attachments only

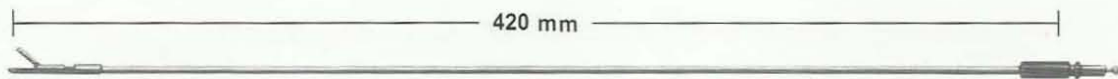

3,5 mm

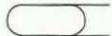

¼ 14-119

3,5 mm



¼ 14-120

4,0 mm

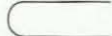

¼ 14-121

4,0 mm



¼ 14-122

14-119 - 122
Handle for 119 - 120 - 121 - 122

Biopsy Forceps

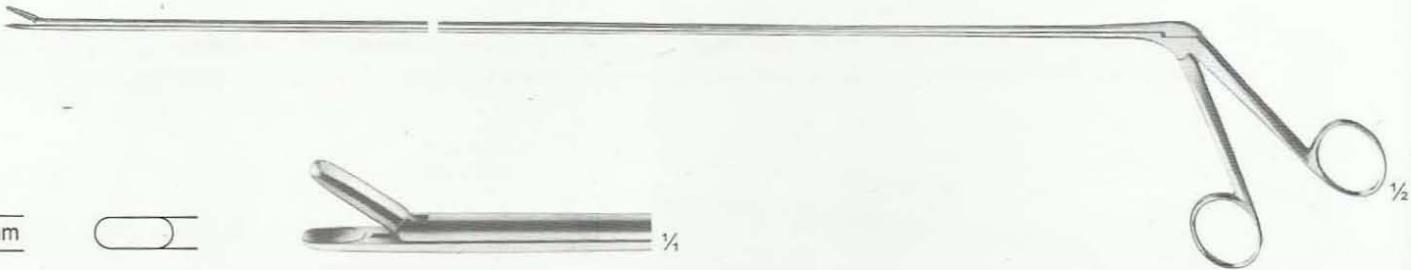

3,5 mm



¼

14-123 - 124
Biopsy Forceps, spoon-shaped
oval jaws, straight.
14-123 350mm
14-124 500mm

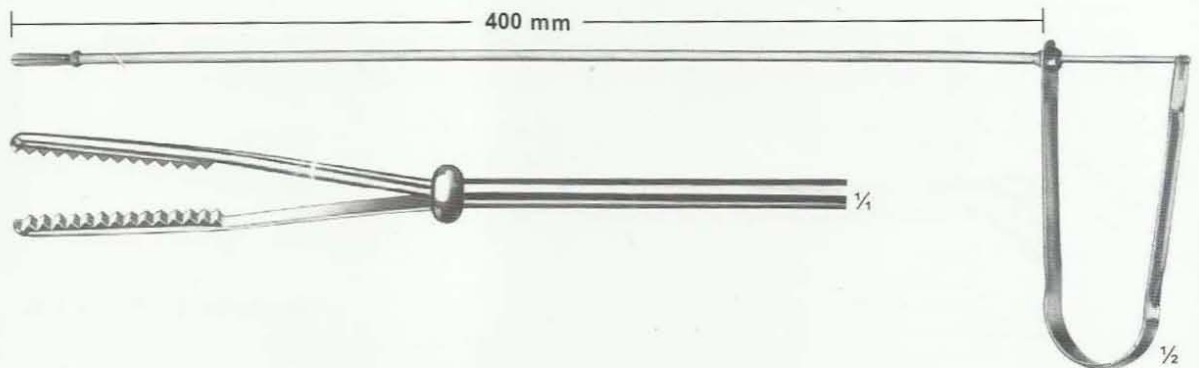

400 mm



¼

½



14-126
220 mm

14-127
245 mm

14-126 - 127
LUER

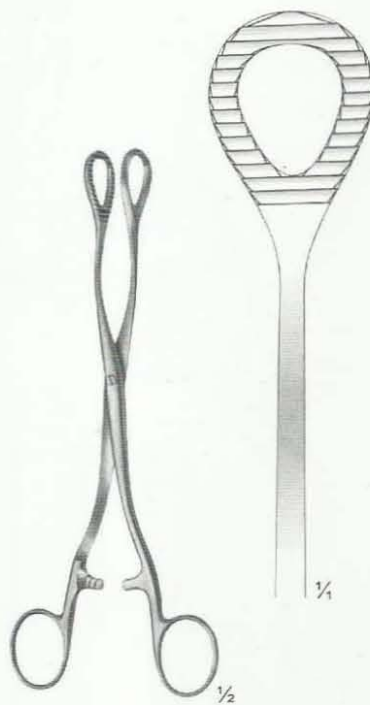

14-128
HEYWOOD-SMITH
200 mm



14-129
HEYWOOD-SMITH
modif
215 mm

Atraumata



14-130

14-131

Pressure Clamp

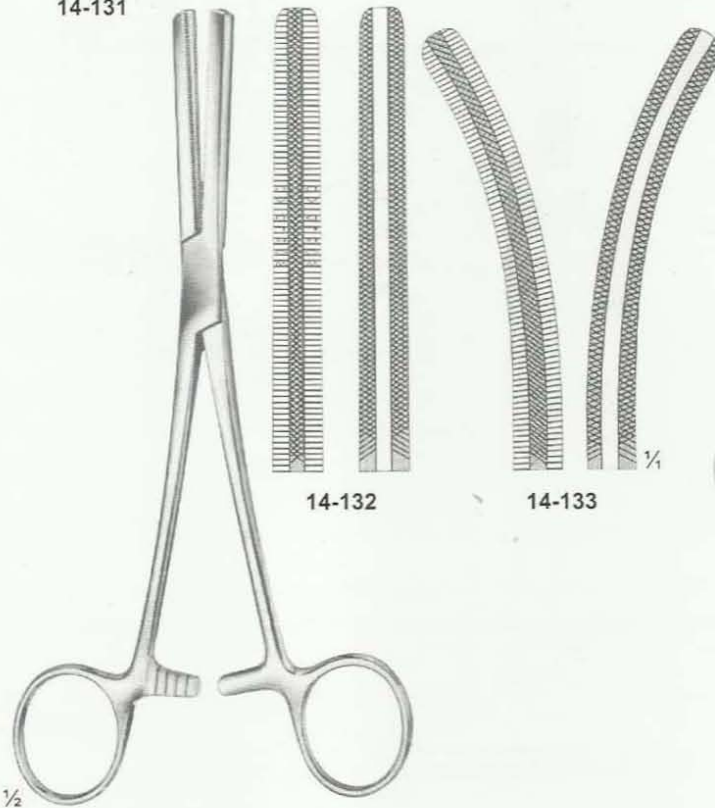

14-132

14-133



1/2

14-130
250 mm-14-131
270 mm

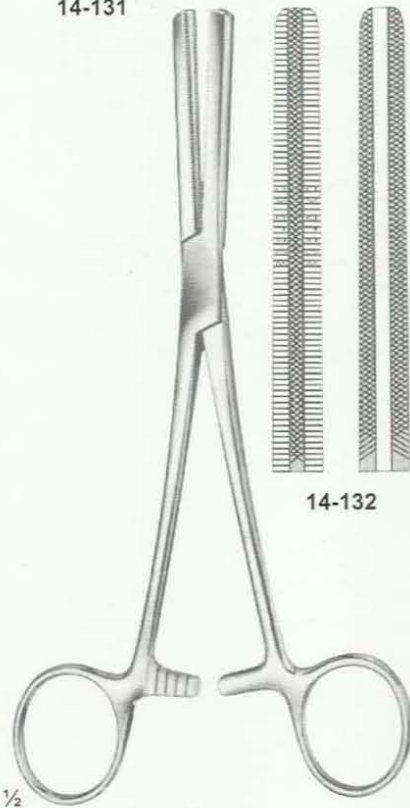

1/2

14-132 - 133
FERGUSSON
200 mm



1/2

14-134
RUDD
Haemorrhoidal ligator
with loading
attachment and 100
ligature rubber rings



14-135
LOWER
180 mm



14-136
LAHEY (SWEET)
190 mm



14-137
LAHEY
220 mm

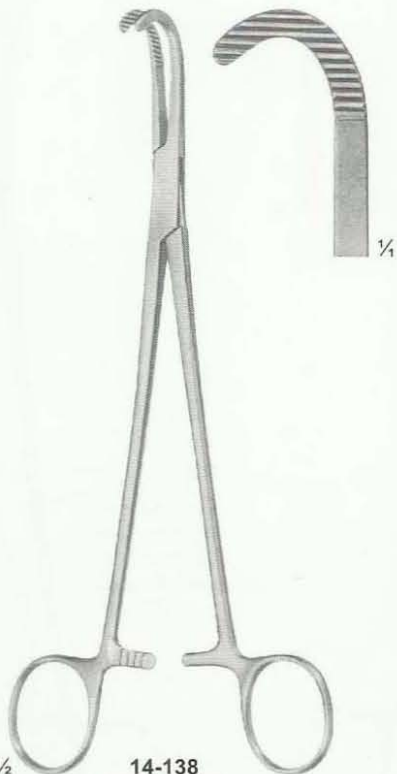

14-138
DESJARDINS
Gall duct-and cystic forceps
210 mm

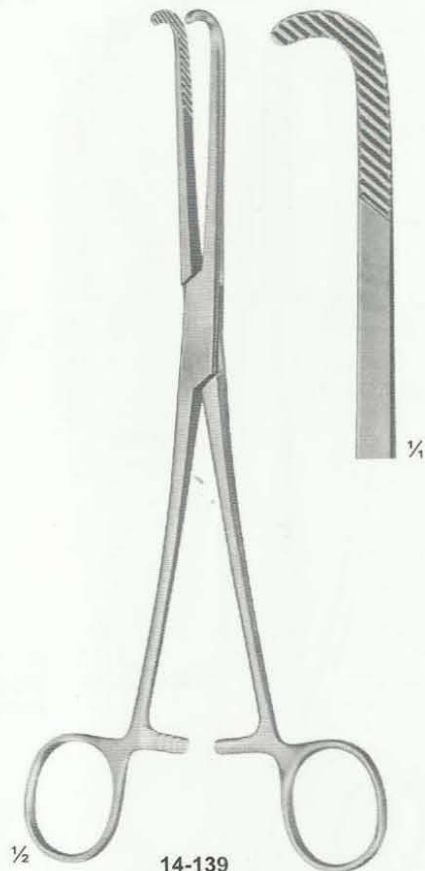

14-139
NISSEN
Gall duct-and cystic forceps
215 mm

Rectum
Vasectomy Set

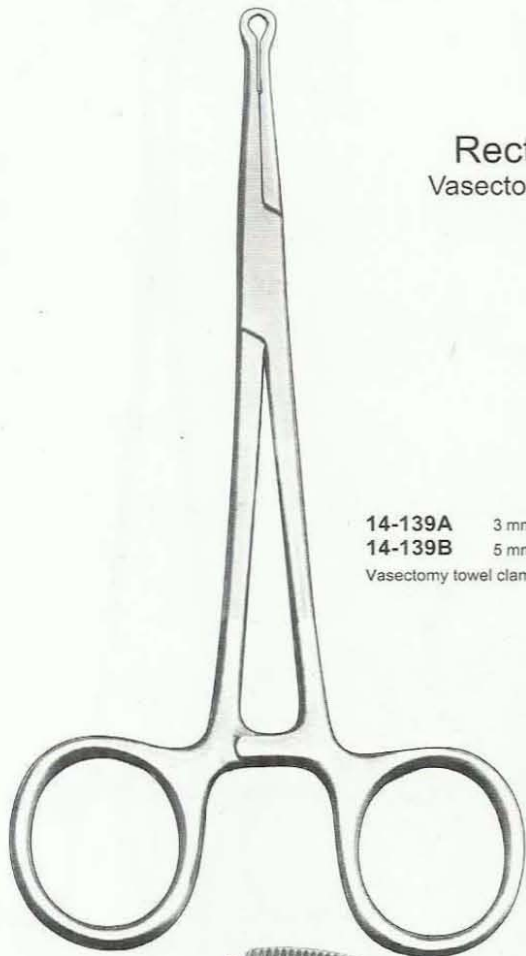

14-139A 3 mm tip
14-139B 5 mm tip
Vasectomy towel clamp



14-139C 12 cm
14-139D 14 cm
Vasectomy forceps



14-139E
Vasectomy hook

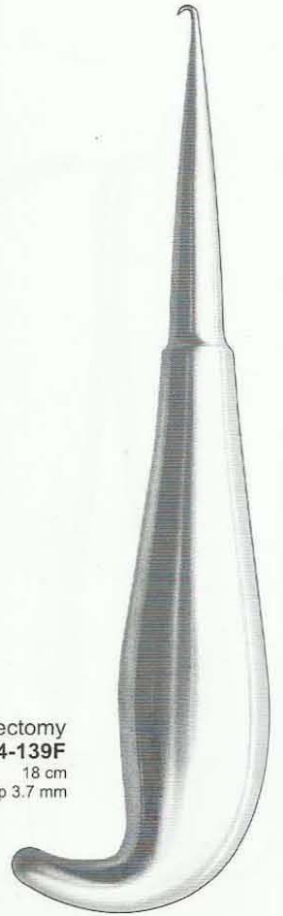

Vasectomy
14-139F
18 cm
Tip 3.7 mm

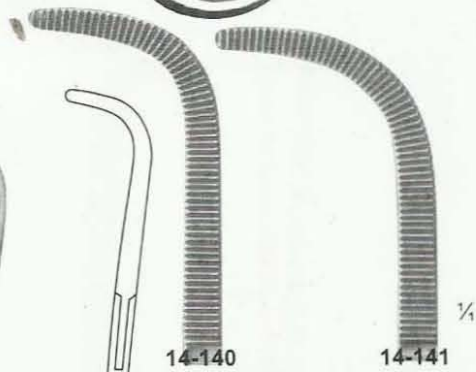

14-140

14-141



14-142

14-143

14-144

Cholecystectomy Forceps

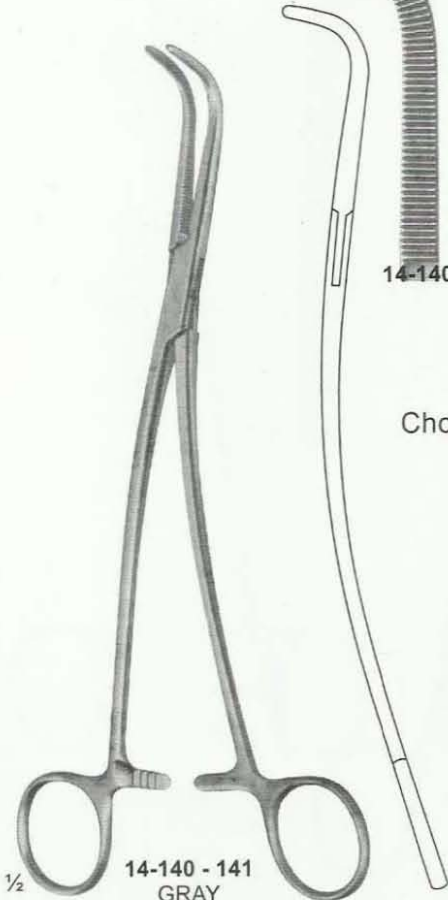

1/2 14-140 - 141
GRAY
220 mm

14-142-143
HOSEMANN
Choledochus forceps
215mm



1/2

14-144
MIXTER
Gall duct
and cystic forceps
230mm



1/2

Atraumata

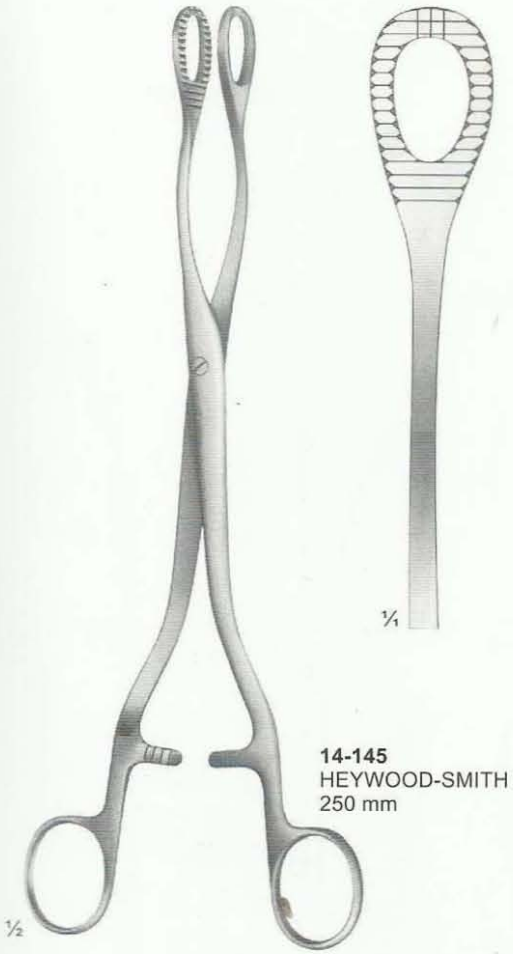

14-145
HEYWOOD-SMITH
250 mm

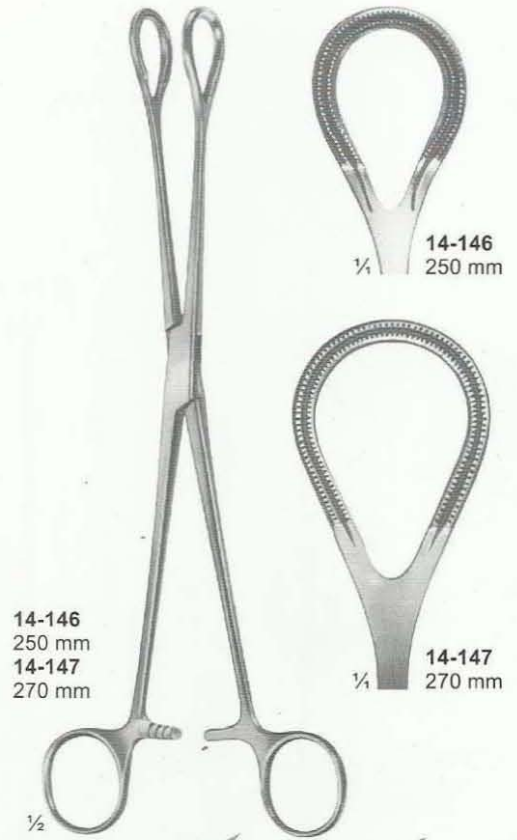

14-146
250 mm
14-147
270 mm

14-146
250 mm

14-147
270 mm

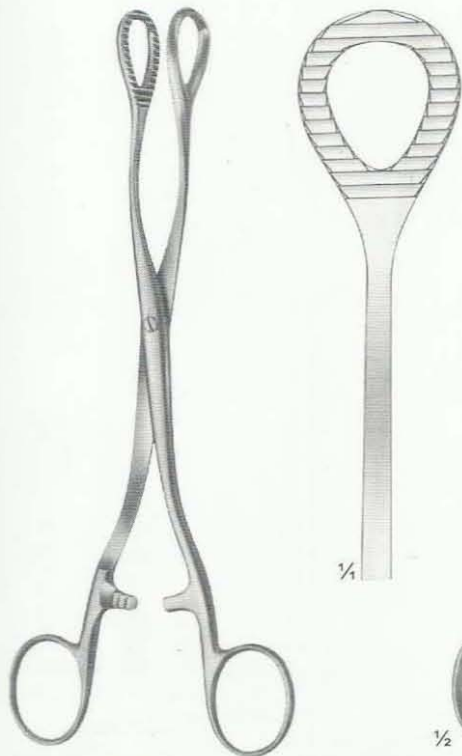

14-148
HEYWOOD-SMITH
200 mm



14-149
DOYEN
185 mm



14-150
POTTS-DE
MARTEL

14-151
MILLS

14-150 - 151
Gall duct scissors
220 mm

Ø 3.5 mm



14-152
HAJEK
Irrigating cannula,
silver
165 mm

Ø 5 mm



14-153
MOYNIHAN
Gall stone probe
and scoop of tin,
malleable.

Ø 5 mm



14-154
MAYO
Gall duct probes,
malleable
330 mm

Ø 3.5 mm

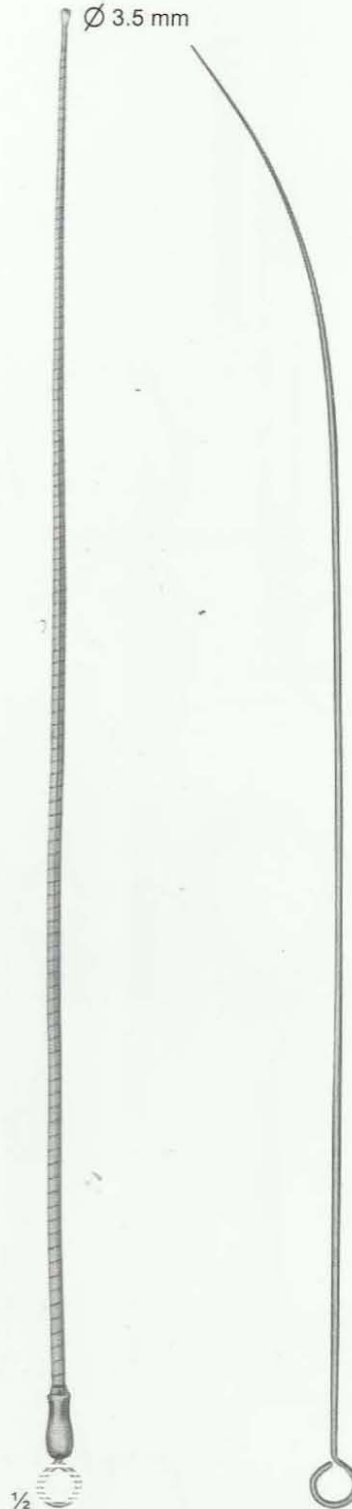

14-155
OCHSNER
Gall duct probes, flexible
400 mm

Ø 3.8 mm



14-156



14-157
Ø 4.3 mm



14-158
Ø 6.8 mm

14-156 - 158
DESJARDINS
Gall duct probes,
flexible

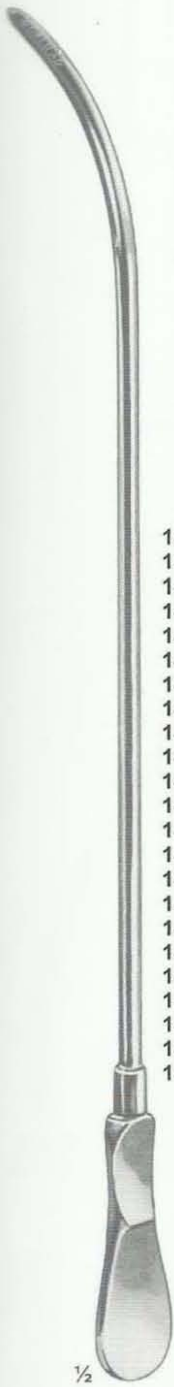

Charr
(French)

- 14-159 8
- 14-160 9
- 14-161 10
- 14-162 11
- 14-163 12
- 14-164 13
- 14-165 14
- 14-166 15
- 14-167 16
- 14-168 17
- 14-169 18
- 14-170 19
- 14-171 20
- 14-172 21
- 14-173 22
- 14-174 23
- 14-175 24
- 14-176 25
- 14-177 26
- 14-178 27
- 14-179 28
- 14-180 29
- 14-181 30

14-159 - 181
DITTEL
Metal bougies and
dilating sounds, stiff
345 mm



14-182 - 194
BAKES
Common bile duct
dilators, malleable
14-182-186 315mm
14-187-194 320mm
(14-194A)
Set of 9 pieces (14-184-192)
in canvas roll
(14-194B) canvas roll only



1/4
14-182
Ø 1 mm



14-183
Ø 2 mm



14-184
Ø 3 mm



14-185
Ø 4 mm



14-186
Ø 5 mm



1/4
14-187
Ø 6 mm



14-188
Ø 7 mm



14-189
Ø 8 mm



14-190
Ø 9 mm



14-191
Ø 10 mm



1/4
14-192
Ø 11 mm



14-193
Ø 12 mm



14-194
Ø 13 mm



14-195 - 198
DESJARDINS
Probes and catch
with flexible shaft
300 mm



1/4
14-195
6 mm



1/4
14-196
7 mm



1/4
14-197
8 mm



1/4
14-198
9 mm



14-199 - 206
LUER-KOERTE
modif with malleable shaft
310 mm

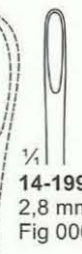

1/4
14-199
2,8 mm
Fig 000



14-200
3,4 mm
Fig 00



14-201
4,3 mm
Fig 0



14-202
5,5 mm
Fig 1



14-203
6,7 mm
Fig 2



14-204
8,0 mm
Fig 3



14-205
11 mm
Fig 4



14-206
15 mm
Fig 5

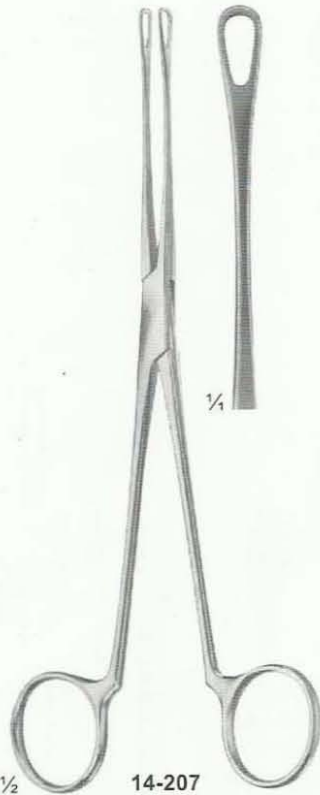

1/2 **14-207**
BLAKE
205 mm

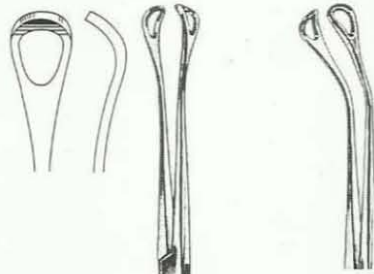

MAYO-BLAKE
14-207B
20 cm

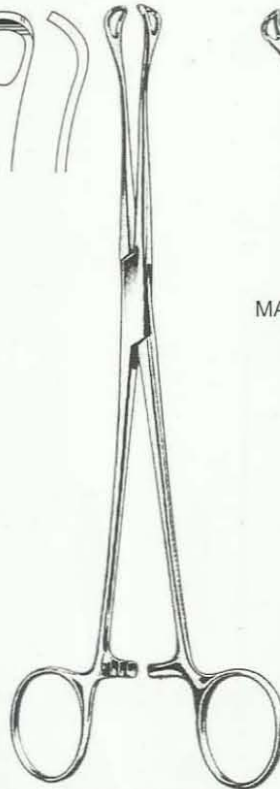

MAYO-BLAKE
14-207A
20 cm

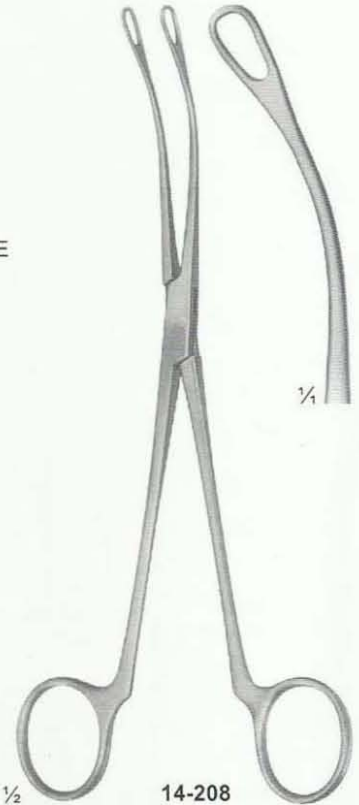

1/2 **14-208**
BLAKE
205 mm

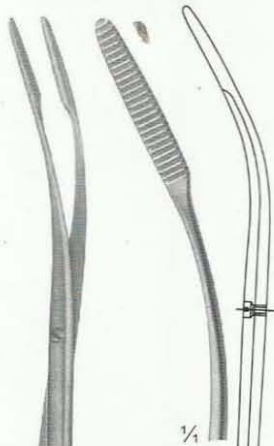

1/2 **14-209**
CZERNY

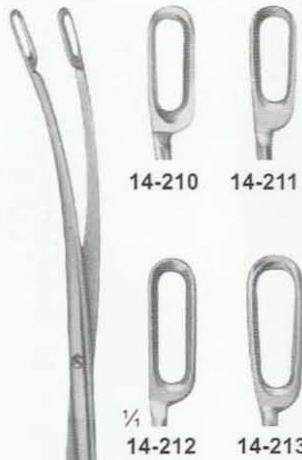

1/2 **14-210 - 213**
DESJARDINS

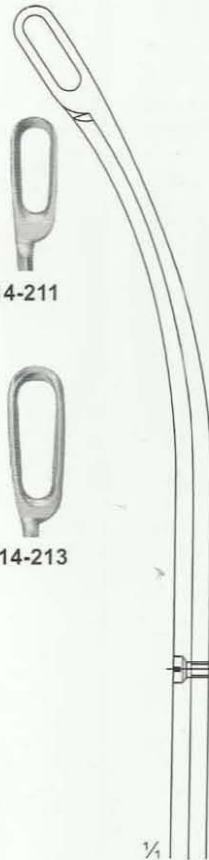

1/2 **14-214 - 215**
DESJARDINS



1/4 **14-214**
240 mm

1/4 **14-215**
225 mm

Atraumata

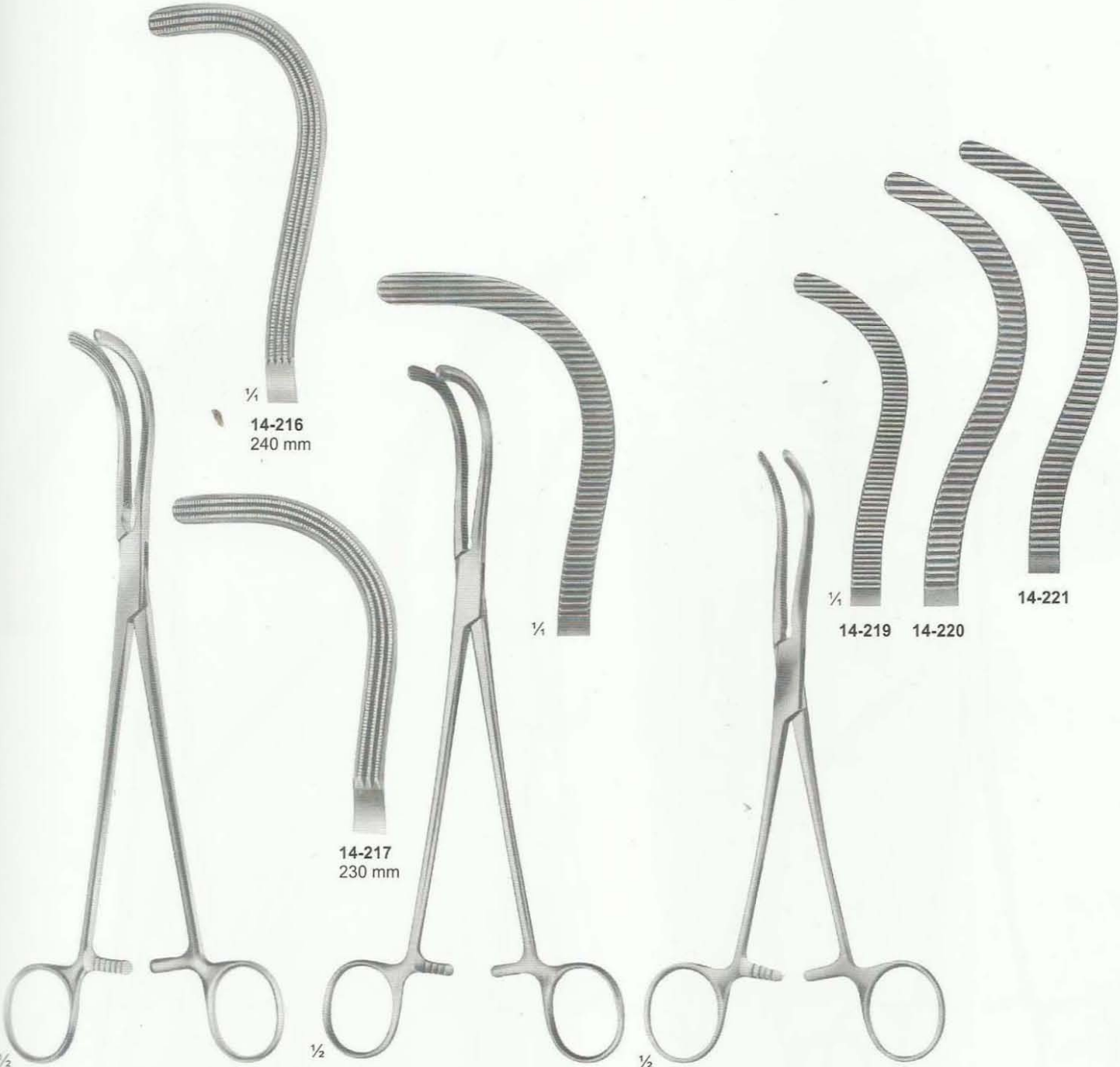

1/4
14-216
240 mm

14-217
230 mm

1/4
14-219 14-220

14-221

1/2
14-216 - 217
GUYON

1/2
14-218
GUYON
230 mm

1/2
14-219 - 221
PEAN
14-219 - 195 mm
14-220 - 220 mm
14-221 - 230 mm

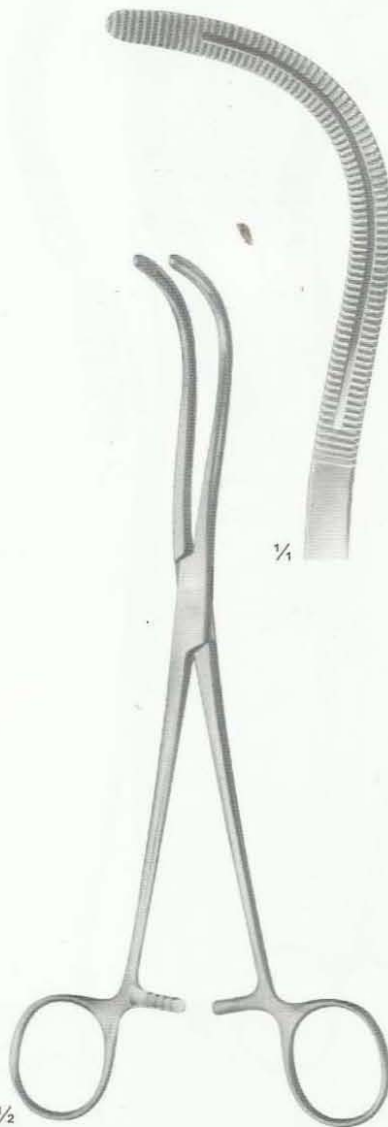

14-222
STILLE
220 mm

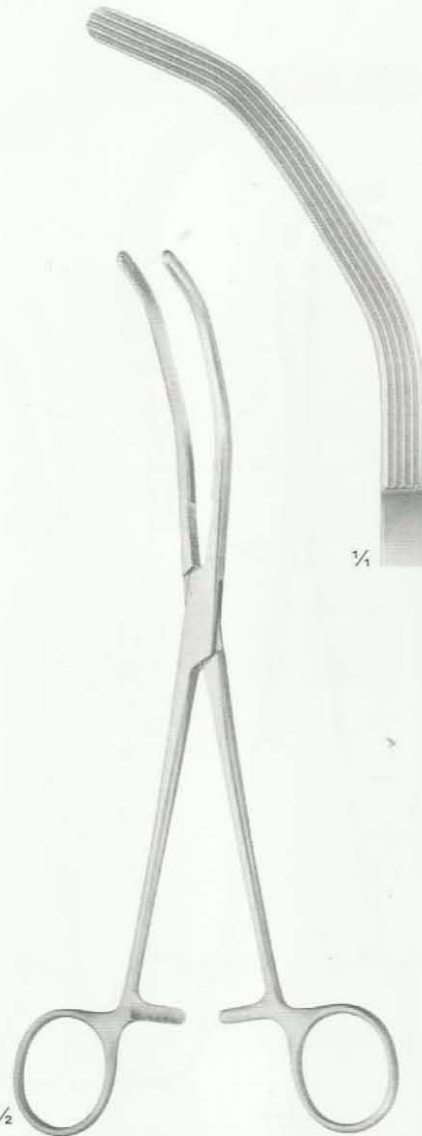

14-223
HERRICK
225 mm



14-224
WERTHEIM
225 mm



14-225
COLLIN
285 mm

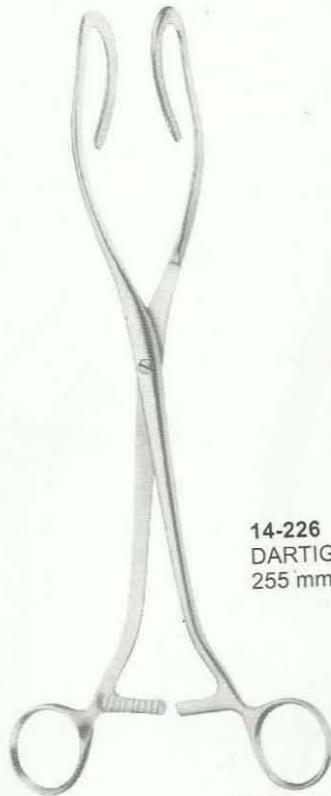

14-226
DARTIGUES
255 mm

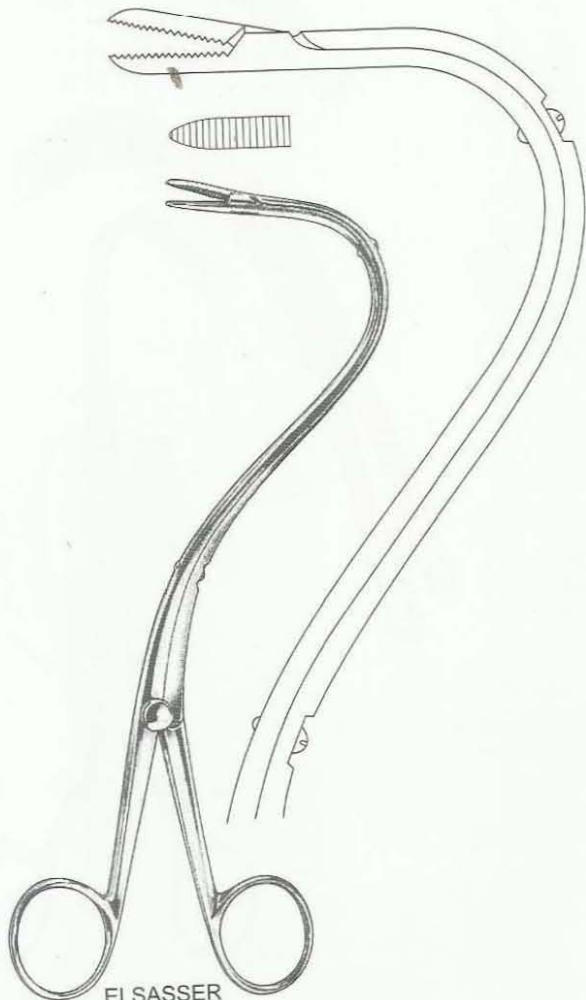

ELSASSER
14-226A

20 cm
Fig. 1

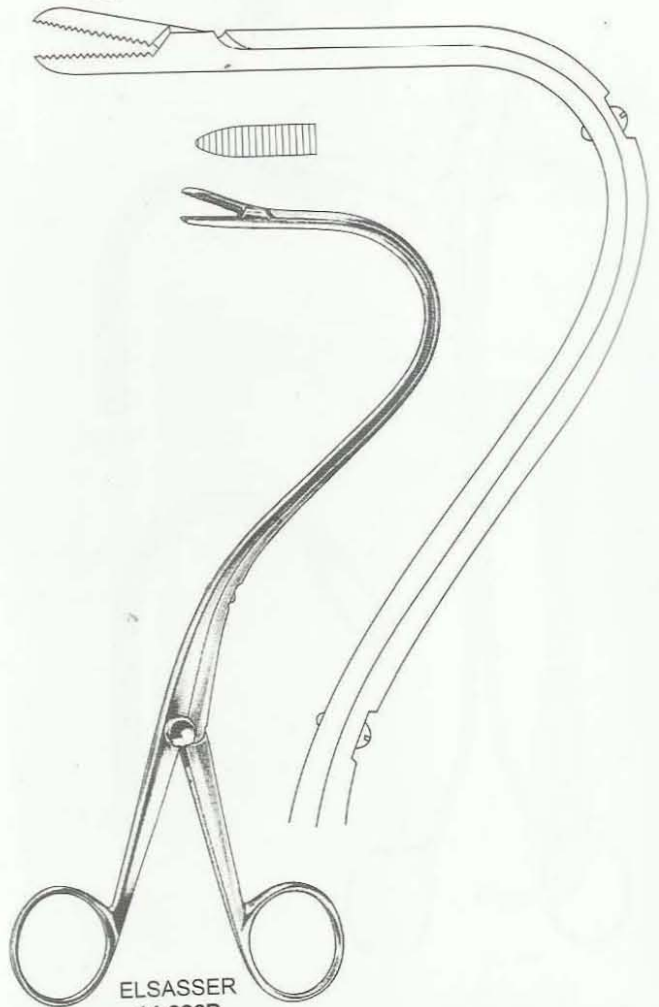

ELSASSER
14-226B

20 cm
Fig. 2



14-227



14-228



14-229



$\frac{1}{4}$
14-230



14-231



$\frac{1}{4}$
14-232



$\frac{1}{2}$

14-231 - 232
RANDALL



$\frac{1}{2}$

14-227 - 230
RANDALL

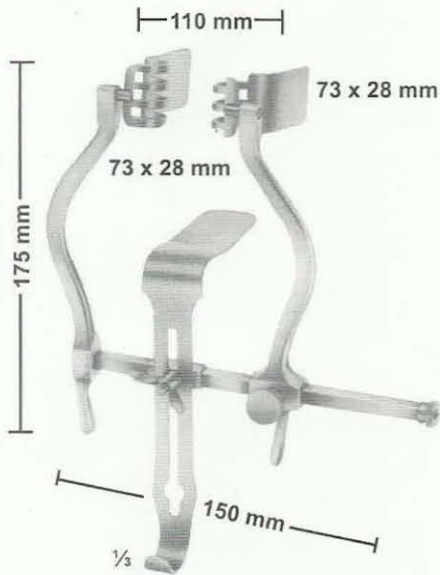

15-101
JUDD-MASSON
 Bladder-and suprapubic
 retractor

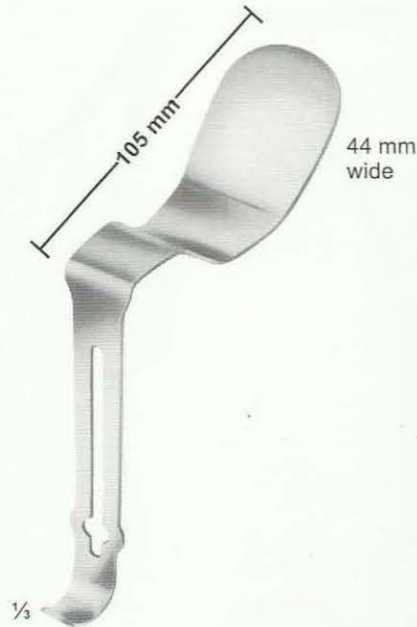

15-102
MILLIN
 Center blade for (15-101)
 retro pubic prostatectomy



15-103
MILLIN
 Bladder retractor
15-103A Spreader only
15-104 Blades 57x25mm
15-105 Blades 82x25mm
15-106 Center blade 105x45mm

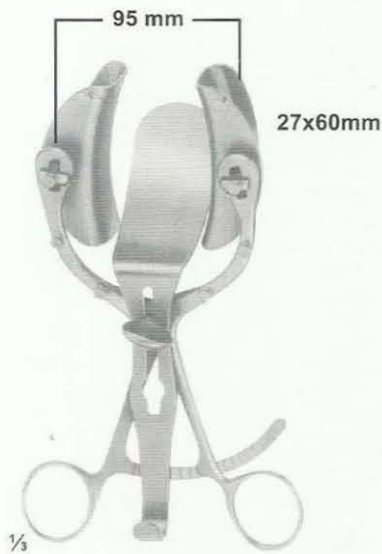

15-107
LEGUEU
 Bladder retractor
 Center blade
 80 x 31 mm



15-108
LEGUEU
 Bladder spatula
 260 mm



15-109
KOCHER
 Bladder spatula
 235 mm



15-110
MATHIEU
Foreign body forceps
Length of shaft
190 mm

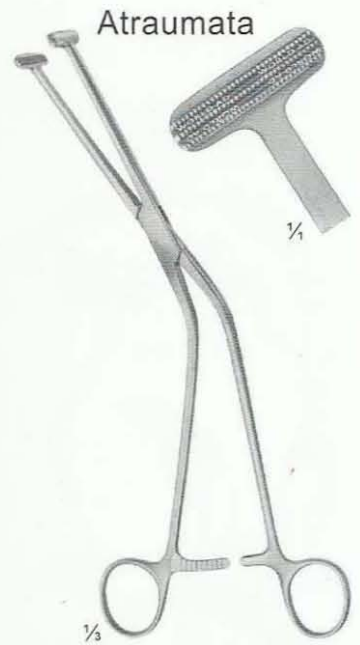

15-111
MILLIN
Lobe grasping
forceps
235 mm



Atraumata

15-112
Ureter forceps
240 mm

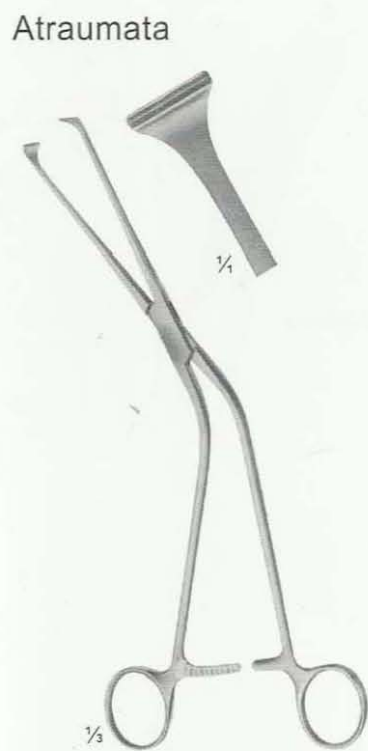

Atraumata

15-113
MILLIN
Lobe grasping
forceps



15-114
MILLIN
Bladder neck spreader
285 mm

15-115
GUYON
Catheter guide
(introducer)
365 mm



1/2



- 15-115-8 15-116-8
- 15-115-9 15-116-9
- 15-115-10 15-116-10
- 15-115-11 15-116-11
- 15-115-12 15-116-12
- 15-115-13 15-116-13
- 15-115-14 15-116-14
- 15-115-15 15-116-15
- 15-115-16 15-116-16
- 15-115-17 15-116-17
- 15-115-18 15-116-18
- 15-115-19 15-116-19
- 15-115-20 15-116-20
- 15-115-21 15-116-21
- 15-115-22 15-116-22
- 15-115-23 15-116-23
- 15-115-24 15-116-24
- 15-115-25 15-116-25
- 15-115-26 15-116-26
- 15-115-27 15-116-27
- 15-115-28 15-116-28
- 15-115-29 15-116-29
- 15-115-30 15-116-30
- 15-115-32 15-116-32
- 15-115-34 15-116-34
- 15-115-36 15-116-36

VEN BUREN
15-115-8 to 15-115-36
Set of 29

Charr.
(French)

- 15-116 6
- 15-117 7
- 15-118 8
- 15-119 9
- 15-120 10
- 15-121 11
- 15-122 12
- 15-123 13
- 15-124 14
- 15-125 15
- 15-126 16
- 15-127 18
- 15-128 20

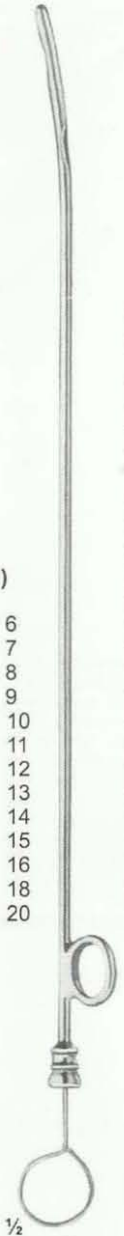

1/2

15-116 - 128
Female catheters,
metal
160 mm

Charr.
(French)

- 15-129 8
- 15-130 9
- 15-131 10
- 15-132 11
- 15-133 12
- 15-134 13
- 15-135 14
- 15-136 15
- 15-137 16
- 15-138 17
- 15-139 18
- 15-140 19
- 15-141 20
- 15-142 21
- 15-143 22
- 15-144 23
- 15-145 24
- 15-146 25
- 15-147 26
- 15-148 27
- 15-149 28
- 15-150 29
- 15-151 30

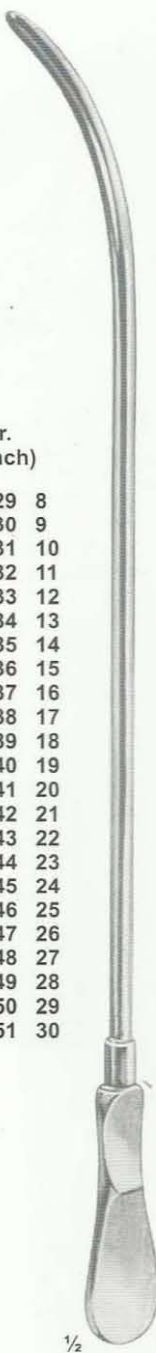

1/2

15-129 - 151
DITTEL
Urethral bougies
and dilating sounds
345 mm

- 15-152 Ben. 24/Charr. 12
- 15-153 Ben. 25
- 15-154 Ben. 26/Charr. 13
- 15-155 Ben. 27
- 15-156 Ben. 28/Charr. 14
- 15-157 Ben. 29
- 15-158 Ben. 30/Charr. 15
- 15-159 Ben. 31
- 15-160 Ben. 32/Charr. 16
- 15-161 Ben. 33
- 15-162 Ben. 34/Charr. 17
- 15-163 Ben. 35
- 15-164 Ben. 36/Charr. 18
- 15-165 Ben. 37
- 15-166 Ben. 38/Charr. 19
- 15-167 Ben. 39
- 15-168 Ben. 40/Charr. 20
- 15-169 Ben. 41
- 15-170 Ben. 42/Charr. 21
- 15-171 Ben. 43
- 15-172 Ben. 44/Charr. 22
- 15-173 Ben. 45
- 15-174 Ben. 46/Charr. 23
- 15-175 Ben. 47
- 15-176 Ben. 48/Charr. 24
- 15-177 Ben. 49
- 15-178 Ben. 50/Charr. 25
- 15-179 Ben. 51
- 15-180 Ben. 52/Charr. 26
- 15-181 Ben. 53
- 15-182 Ben. 54/Charr. 27
- 15-183 Ben. 55
- 15-184 Ben. 56/Charr. 28
- 15-185 Ben. 57
- 15-186 Ben. 58/Charr. 29
- 15-187 Ben. 59
- 15-188 Ben. 60/Charr. 30

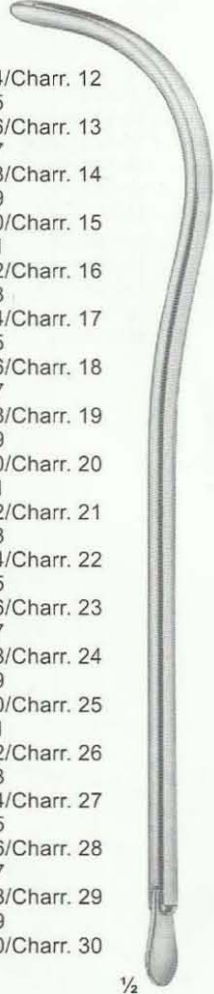

1/2

15-152 - 188
GUYON
Urethral bougies
and dilating sounds,
without filiform guides,
with thread in tip
255 mm



GUYON
15-189
Set of 29; Fig. 8 to Fig. 36

Fr.	Fr.	Fr.
15-189-08	15-189-19	15-189-30
15-189-09	15-189-20	15-189-31
15-189-10	15-189-21	15-189-32
15-189-11	15-189-22	15-189-33
15-189-12	15-189-23	15-189-34
15-189-13	15-189-24	15-189-35
15-189-14	15-189-25	15-189-36
15-189-15	15-189-26	
15-189-16	15-189-27	
15-189-17	15-189-28	
15-189-18	15-189-29	

Assisted by two haemostats or ligatures the foreskin is pushed over the bellshaped protection - rod and the glans is placed into it.
By now, the wing - nut is tightened as close as possible, so the foreskin in annular compressed. The foreskin is cut of with a scalpel, right next to the compression ring.
The circumcision clamp remains a few minutes to avoid bleeding. In case that any large vein, specially the frenular artery, is cut through, a ligature must be set.
The advantage of the method described is the cosmeticy favourable scar which is left after rejection of the small necrotized portion.

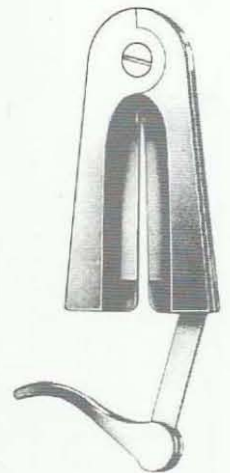

MOGEN
15-192A
7 cm

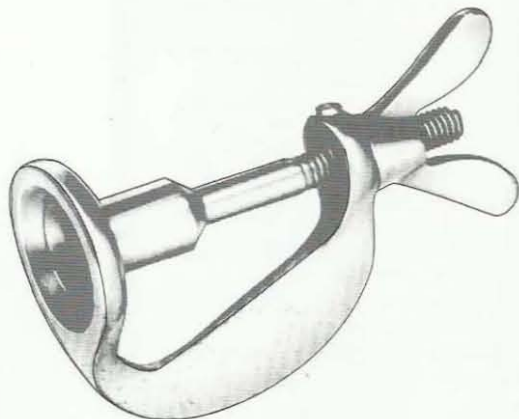

15-190 - 192
WINKELMANN
15-190 12mm \varnothing
15-191 16mm \varnothing

Circumcision Clamps

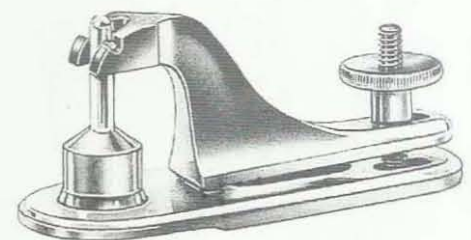

15-190 A 8 mm \varnothing
15-190 B 11 mm \varnothing
15-190 C 13 mm \varnothing
15-190 D 16 mm \varnothing
15-190 E 21 mm \varnothing
15-190 F 26 mm \varnothing

Luer Lock

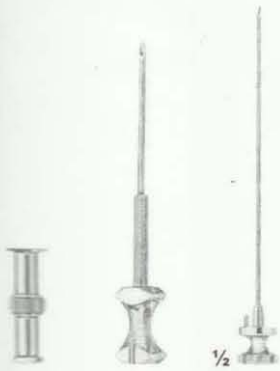

15-193
KLIMA ROSEGGER
35 X 1,8 mm
Sternal puncture needle

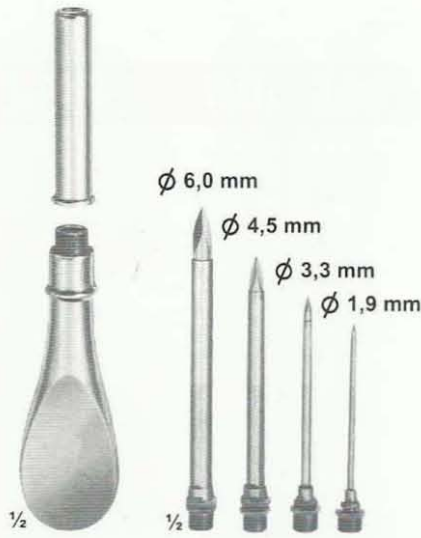

15-194
Universal trocar
with 4 tips



15-195 - 199
NELSON

	Inside diam	Outside diam
15-195	2,2 mm	3,0 mm
15-196	3,0 mm	4,0 mm
15-197	4,0 mm	5,0 mm
15-198	5,0 mm	6,0 mm
15-199	5,5 mm	6,5 mm

for hydrocele and abdominal puncture



15-200 - 203

	Inside diam	Outside diam
15-200	2,2 mm	3,0 mm
15-201	3,0 mm	4,0 mm
15-202	4,0 mm	5,0 mm
15-203	5,0 mm	6,0 mm

for abdominal puncture, with stop-cock and lateral drain

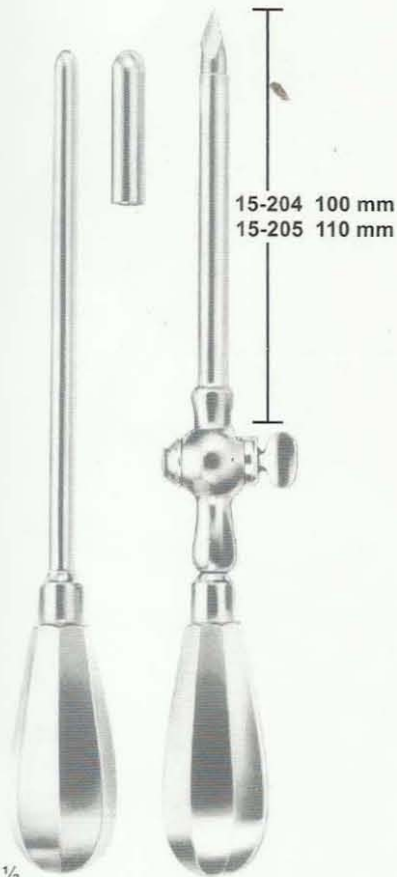

15-204 - 205
BUELAU

	Inside diam	Outside diam
15-204	6,5 mm	8,0 mm
15-205	9,0 mm	10,0 mm

Empyema trocar

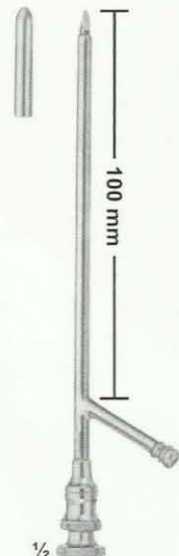

15-206 - 209
OCHSNER

	Inside diam	Outside diam
15-206	3,0 mm	4,0 mm
15-207	3,6 mm	4,6 mm
15-208	4,3 mm	5,3 mm
15-209	5,0 mm	6,0 mm

Gall bladder trocars



15-210
PIERCE
Antrum trocar
ø 4,0 mm

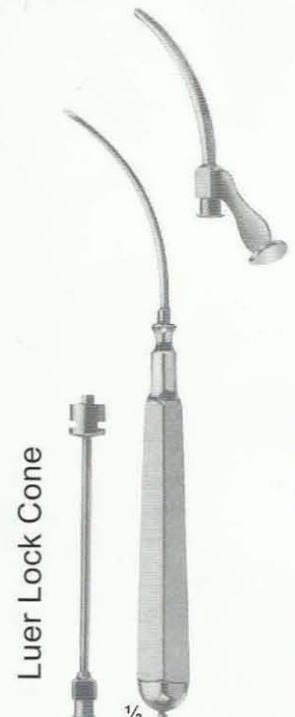

15-211
COAKLEY
Antrum trocar
ø 3,0 mm

	SECTION	PAGE
--	---------	------

Vaginal Specula Retractors	16	209-220
-------------------------------	----	---------

Utrine Dilators, Probes, Forceps, Myoma Instruments	17	
	18	221-236

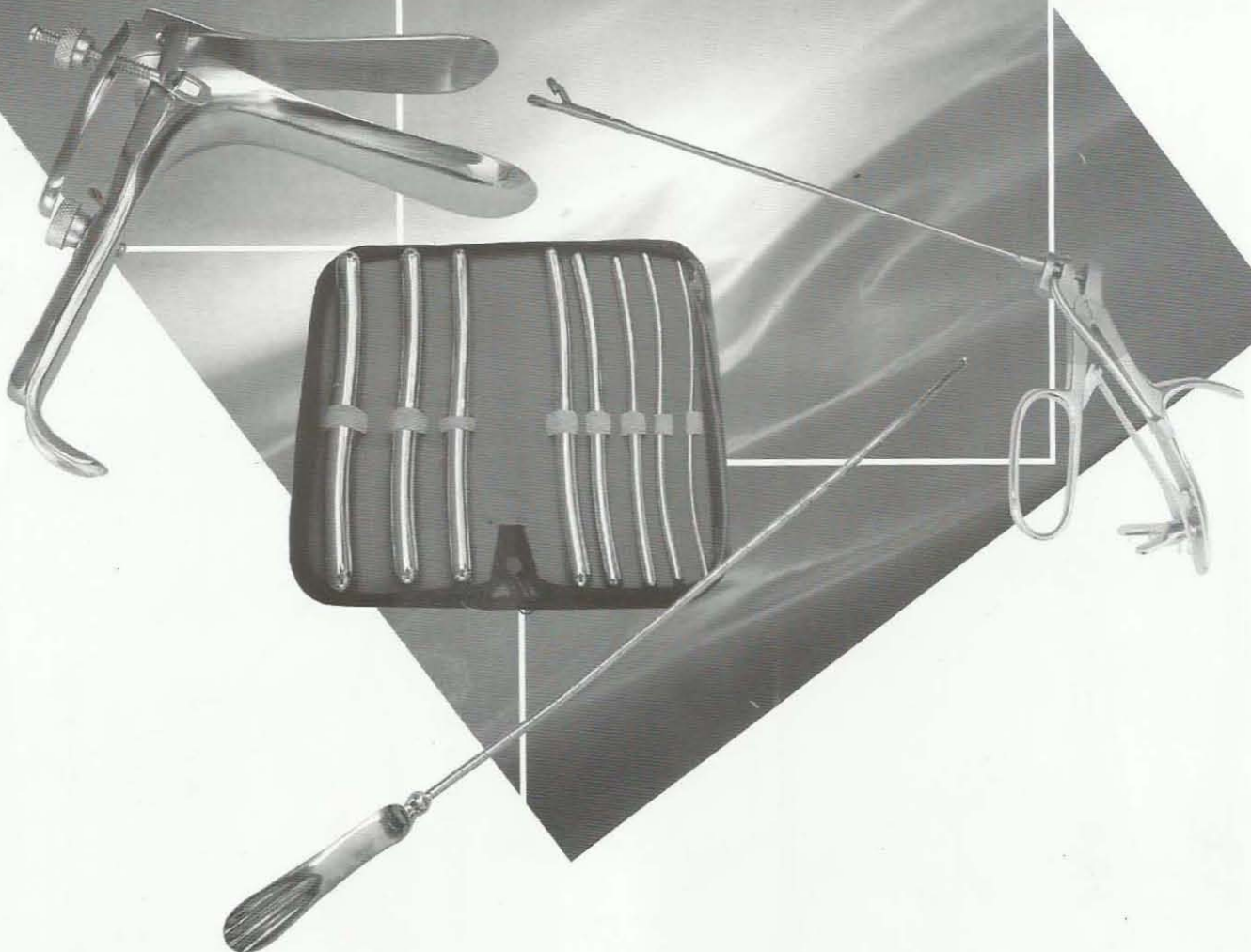

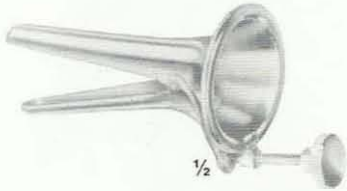

16-101
COLLIN
for children
53 x 10 mm

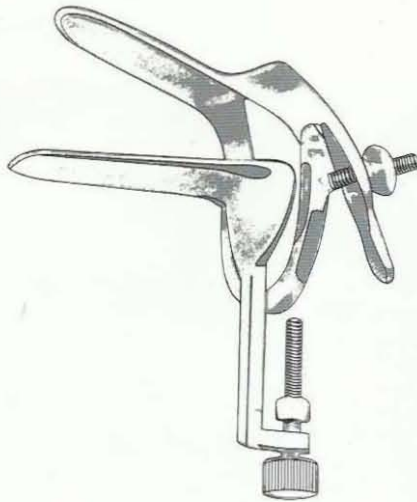

CLUM
16-101A
Sakurai's vaginal speculum

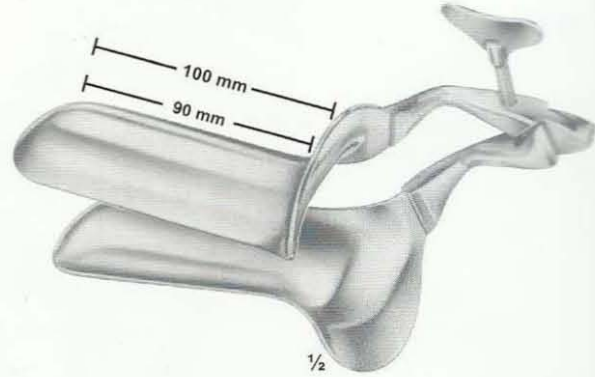

16-102 - 105
COLLIN
16-102 100/90mm 28 mm
16-103 100/90mm 32 mm
16-104 105/95mm 35 mm
16-105 115/105mm 40 mm
Total length/working width length



16-106
COLLIN
for virgins
95/85 x 18 mm

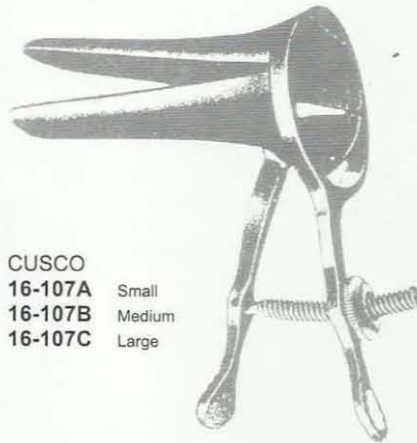

CUSCO
16-107A Small
16-107B Medium
16-107C Large

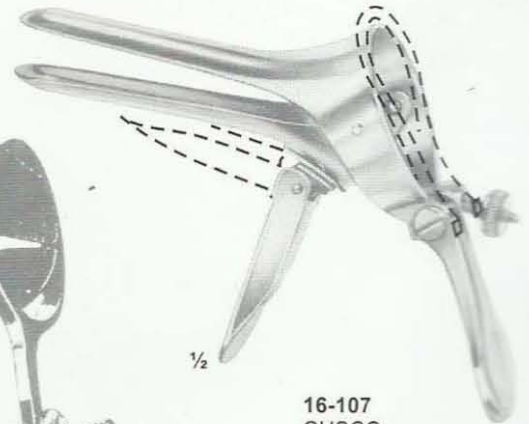

16-107
CUSCO
for virgins
75 x 17 mm



16-108
CUSCO
for virgins
75 x 17 mm

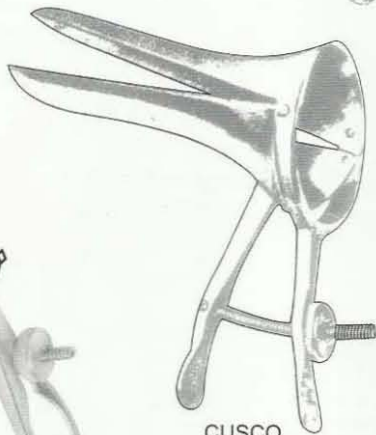

CUSCO
Japanese model
16-108A Small
16-108B Medium
16-108C Large
Stainless steel forged handle
16-108D Small
16-108E Medium
16-108F Large
Stainless steel sheet handle

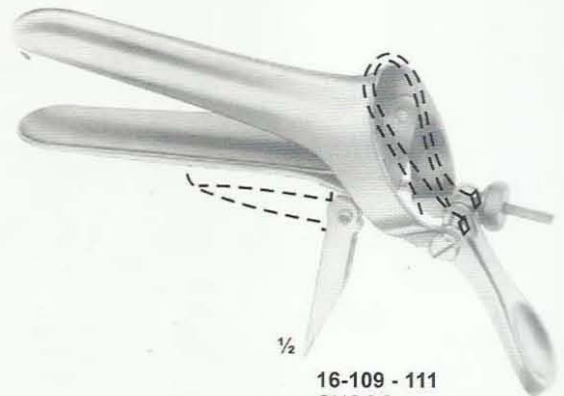

16-109 - 111
CUSCO
Swiss patterns features:
long and narrow
16-109 92x23-25 mm
16-110 100x25-27 mm
16-111 110x27-30 mm

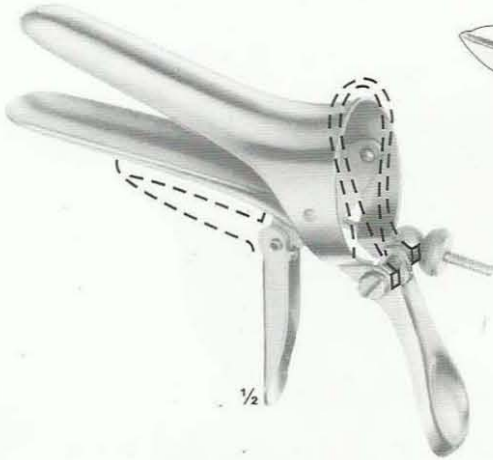

16-112 - 115
CUSCO
STANDARD
16-112 80X24 mm
16-113 80X32 mm
16-114 90X36 mm
16-115 110X37 mm

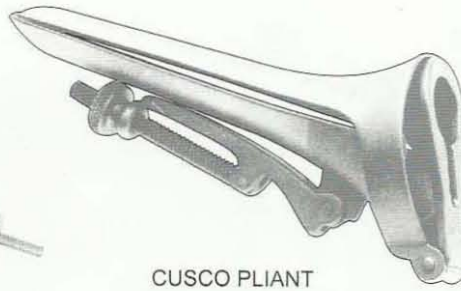

CUSCO PLIANT

- 16-112 A 16 x 100 mm
- 16-112 B 20 x 100 mm
- 16-112 C 25 x 100 mm
- 16-112 D 28 x 100 mm
- 16-112 E 30 x 100 mm
- 16-112 F 32 x 100 mm
- 16-112 G 36 x 100 mm

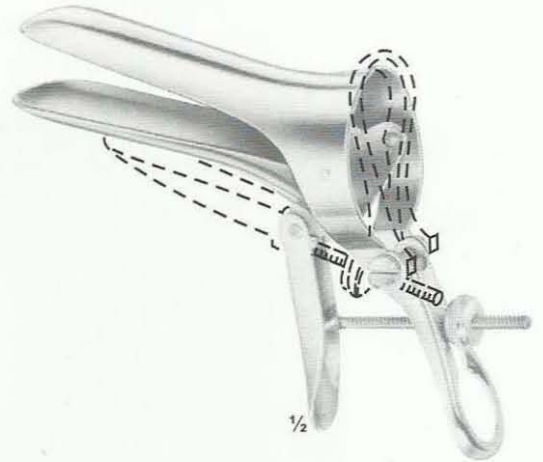

16-116 - 119
CUSCO
16-116 80X24 mm
16-117 80X32 mm
16-118 90X36 mm
16-119 110X37 mm

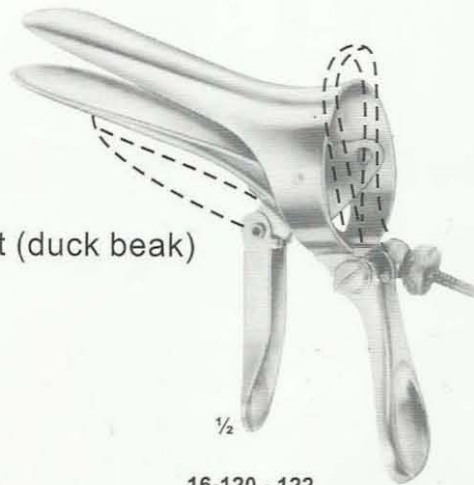

Flat (duck beak)

16-120 - 122
CUSCO
16-120 80X32 mm
16-121 90X37 mm
16-122 115X37 mm

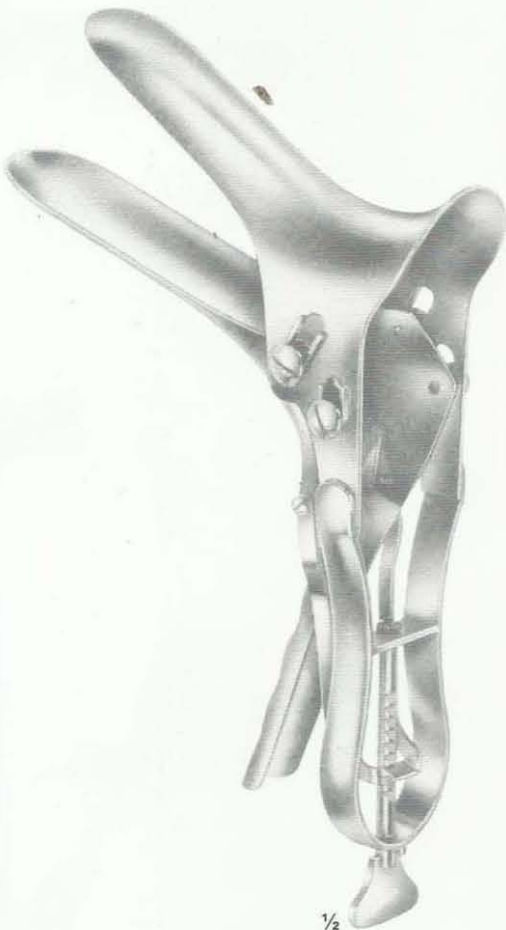

16-123 - 124
SEYFFERT
16-123 100X17 mm
16-124 110X33 mm
230 mm



CUSCO FIXE

- 16-112 H 16 x 100 mm
- 16-112 J 25 x 100 mm
- 16-112 K 32 x 100 mm
- 16-112 L 35 x 100 mm
- 16-112 M 40 x 100 mm

With double ratchet, closing and opening of ratchet by pressure of thumb

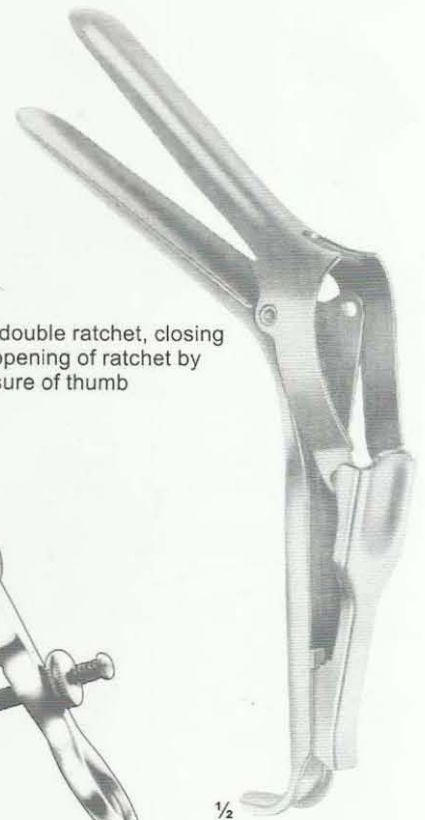

16-125
SEMM
for children and virgins
180 mm
80X14 mm



16-126 - 128
GRAVE
16-126 75X20 mm
16-127 95X30 mm
16-128 105X33 mm

1/2



16-129 - 130
PEDERSON
16-129 100X22 mm
16-130 120X25 mm

1/2



16-131 - 132
BRIESKY
16-131 72X25 mm / 77X30 mm 140mm
16-132 75X30 mm / 92X38 mm 170mm

1/2



16-133 - 135
SIMS
16-133 70X26 mm / 75 X30 mm
125 mm
16-134 75X30 mm / 80X35 mm
150 mm
16-135 80X36 mm / 90X40mm
175mm

1/2

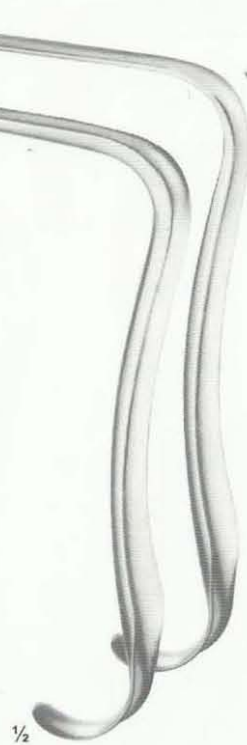

16-136 - 138
SEIDL
16-136 80X8 mm
16-137 80X10 mm
16-138 90X14 mm
For children and infants
170 mm

1/2



16-139
KRISTELLER
70X15 mm, (170 mm)
For children

1/2

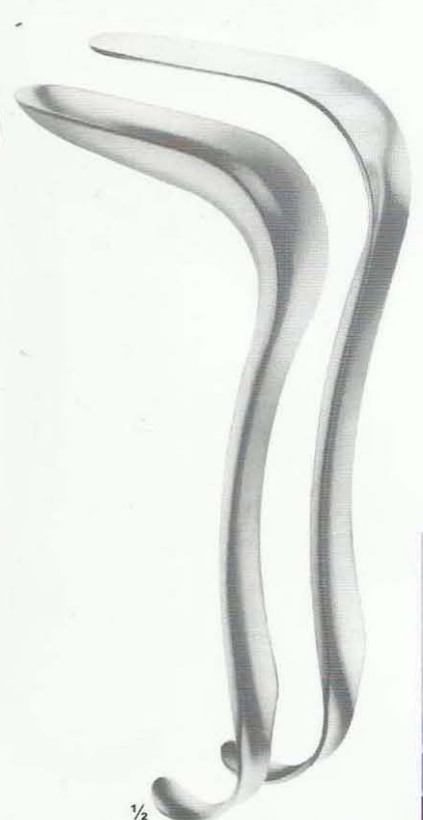

16-140 - 142
KRISTELLER
16-140 70X27 mm
16-141 75X30 mm
16-142 90X36 mm
175 mm

1/2

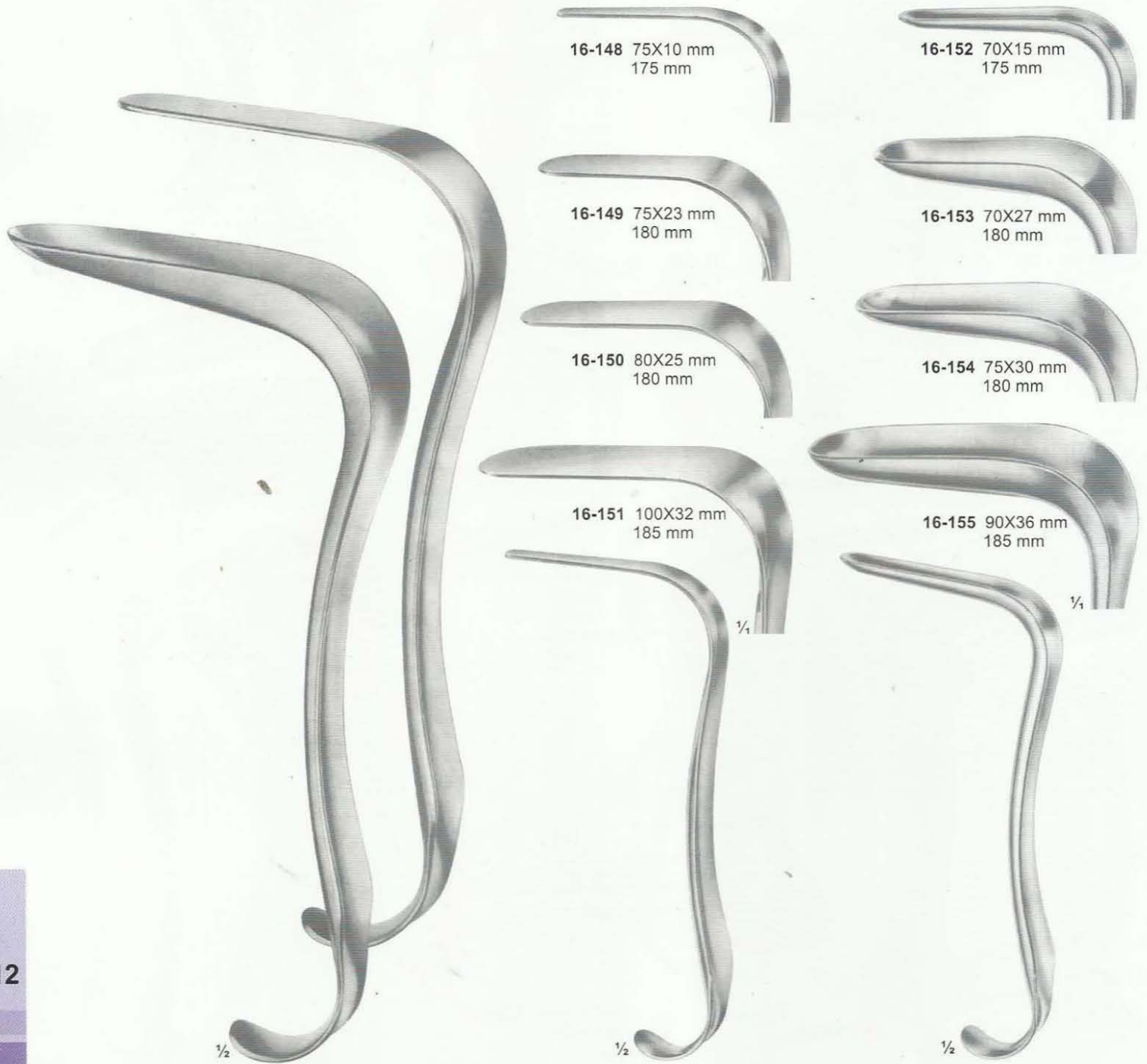

16-148 75X10 mm
175 mm

16-152 70X15 mm
175 mm

16-149 75X23 mm
180 mm

16-153 70X27 mm
180 mm

16-150 80X25 mm
180 mm

16-154 75X30 mm
180 mm

16-151 100X32 mm
185 mm

16-155 90X36 mm
185 mm

16-143 - 147
KRISTELLER
16-143 110X18 mm
16-144 110X20 mm
16-145 110X27 mm
16-146 110X30 mm
16-147 110X36 mm
220 mm

16-148 - 151
KRISTELLER
Upper blades

16-152 - 155
KRISTELLER
Lower blades

16-156 115X14 mm
215 mm

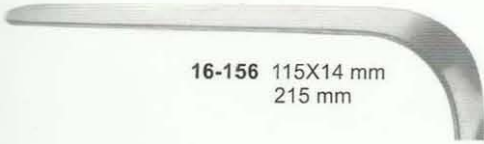

16-157 115X23 mm
215 mm

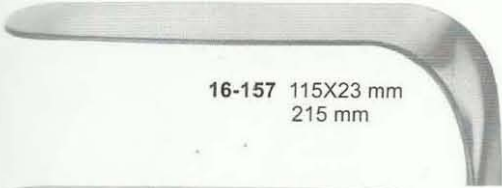

16-158 115X16 mm
220 mm

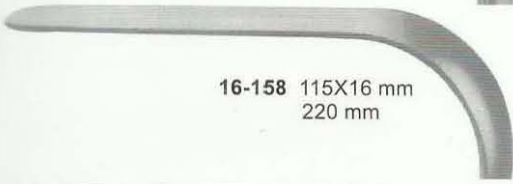

16-159 115X26 mm
220 mm

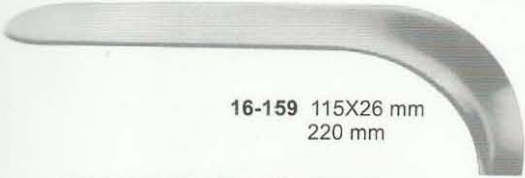

16-160 120X30 mm
225 mm



16-156 - 160
KRISTELLER
Upper blades



16-161 110X18 mm
215 mm



16-162 110X27 mm
215 mm



16-163 110X20 mm
220 mm



16-164 110X30 mm
220 mm



16-165 110X36 mm
225 mm



16-161 - 165
KRISTELLER
Lower blades



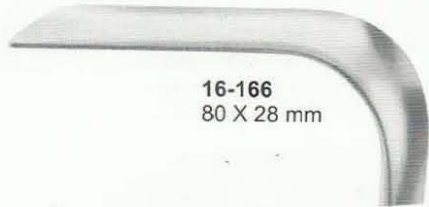

16-166 - 168
KRISTELLER
205 mm

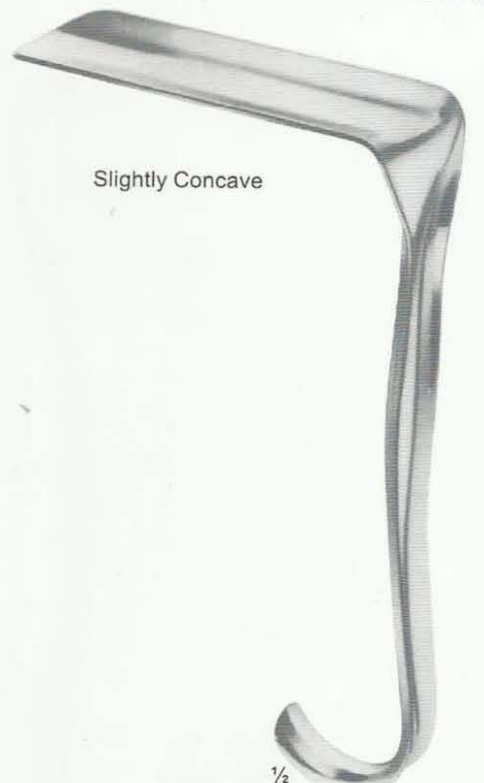
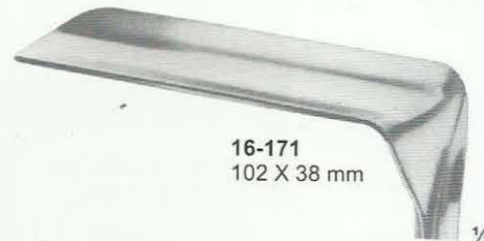

16-169 - 171
JACKSON
175 mm

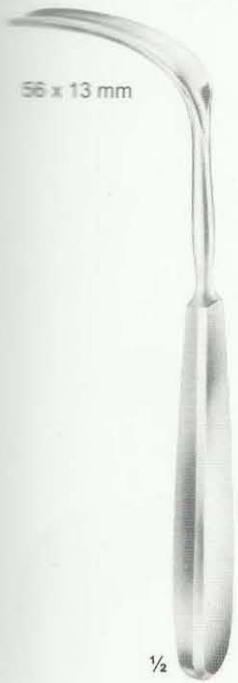

56 x 13 mm

1/2

16-172
BRAUN
180 mm



60 x 10 mm

1/2

16-173
BRAUN
180 mm

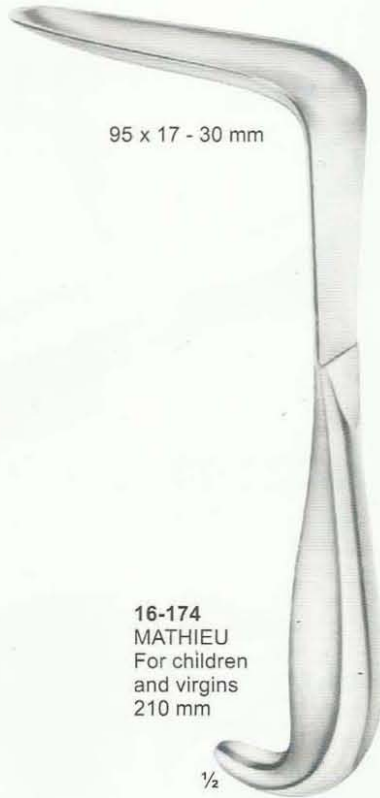

95 x 17 - 30 mm

1/2

16-174
MATHIEU
For children
and virgins
210 mm



95 x 17-26 mm

1/2

16-175
MATHIEU
for children and
virgins fitting(16-174)
210 mm



16-177

16-178

16-179

16-180

16-181

- 16-177 110x14mm
- 16-178 110x23mm
- 16-179 110x16mm
- 16-180 110x26mm
- 16-181 115x30mm

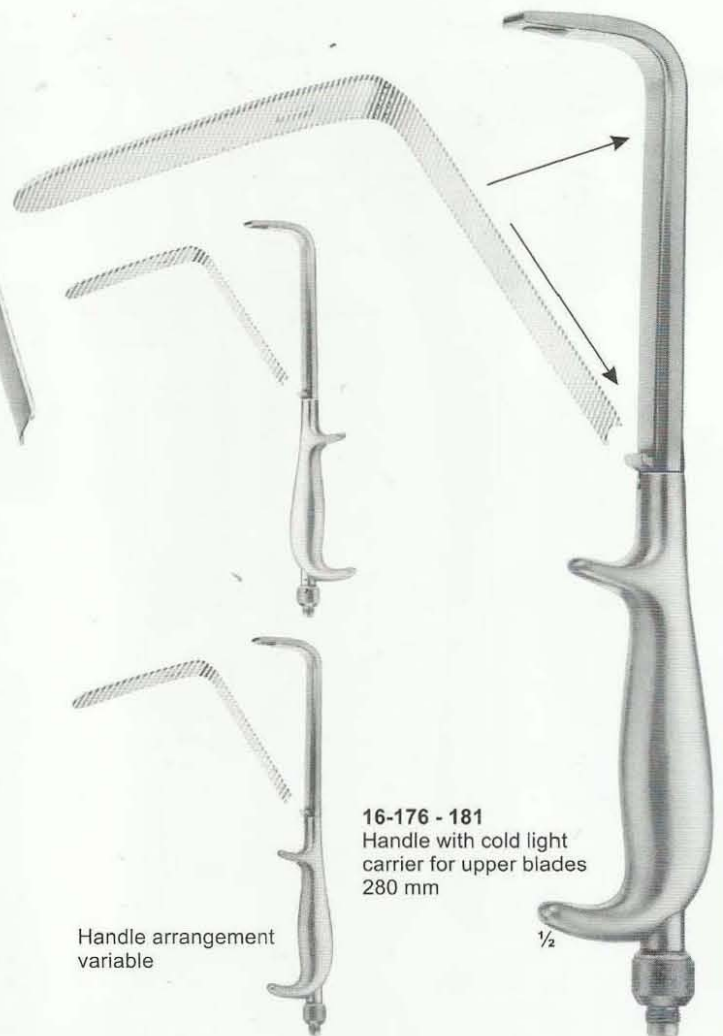

16-176 - 181
Handle with cold light
carrier for upper blades
280 mm

Handle arrangement
variable

1/2



JAYLE
16-181A 60 x 40 mm, 60 x 40 mm
16-181B 90 x 40 mm, 90 x 40 mm
 Blade with weight

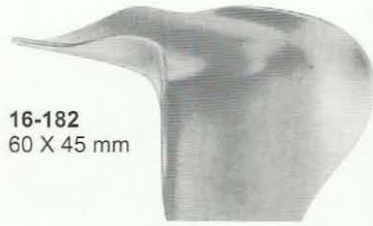

16-182
 60 X 45 mm

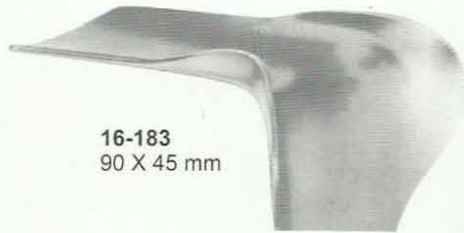

16-183
 90 X 45 mm



16-184
 112 X 45 mm



$\frac{1}{2}$
16-182 - 184
 DOYEN
 235 mm



$\frac{1}{2}$
16-185 - 195
 DOYEN
 240mm

Length of blades	Width of blades		
	35 mm	45 mm	60 mm
60 mm	16-185	16-188	16-192
90 mm	16-186	16-189	16-193
120 mm	16-187	16-190	16-194
160 mm	16-191	16-195	

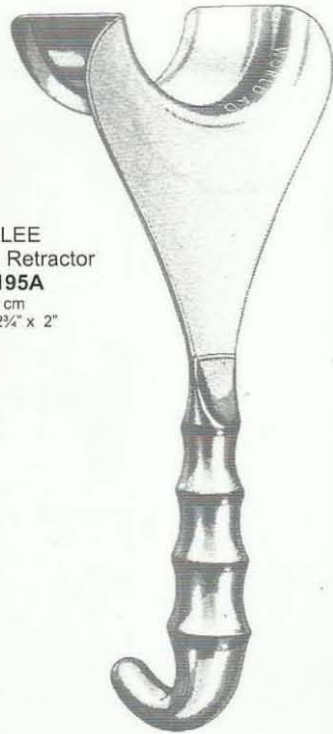

DE LEE
Universal Retractor
16-195A
24 cm
Blade 2 1/4" x 2"



1/2



1/2



16-208
removable strainer only

1/2

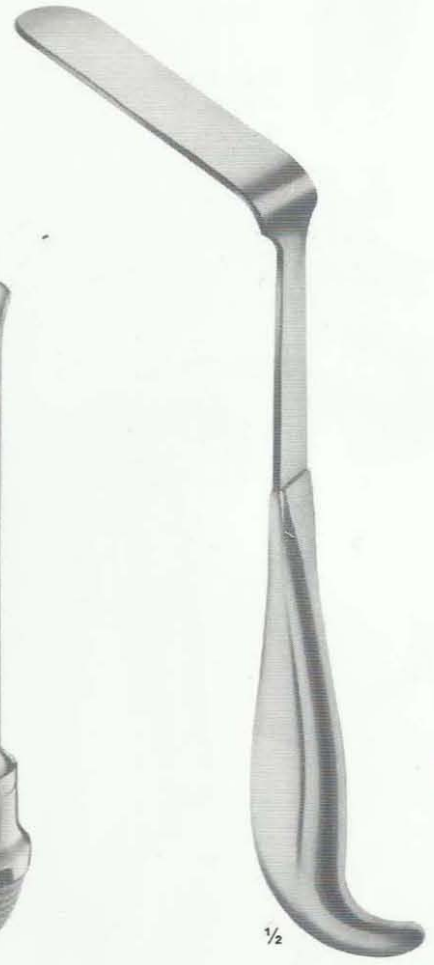

1/2

16-196 - 200
BREISKY
WIENER MODELL/
VIENNA PATTERN
16-196 100 X 20 mm
16-197 100 X 25 mm
16-198 100 X 30 mm
16-199 100 X 35 mm
16-200 100 X 40 mm
300 mm

16-201 - 205E
BREISKY
320 mm

16-201 130 x 20 mm
16-202 130 x 25 mm
16-203 130 x 30 mm
16-204 130 x 35 mm
16-205 130 x 40 mm
16-205A 155 x 40 mm
16-201A 100 x 20 mm
16-202B 100 x 25 mm
16-203C 100 x 30 mm
16-204D 100 x 35 mm
16-205E 100 x 40 mm

16-206 - 207
WEISSBARTH
16-206 80 X 28 mm
16-207 85 X 42 mm
210 mm

16-209
DOYEN
lateral speculum
80 x 30 mm
250 mm



16-210 - 211
SIMON
115 X 22 mm
275 mm

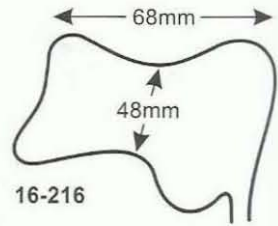

16-216

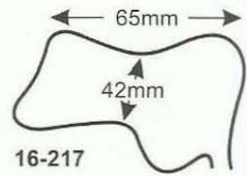

16-217

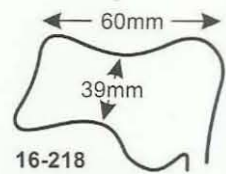

16-218

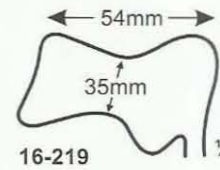

16-219

16-211
115 X 26 mm
275 mm



16-212
AUVARD
65 X 38 mm - 28 mm
1,530 kg = 3 lbs
with fixed weight
230 mm



16-213 - 214
AUVARD
16-213 75 X 42-40 mm
16-214 105 X 43-40 mm
1,470 kg = 3 lbs
with detachable weight
230 mm



16-216 - 219
MARTIN
with hook shaped
handle for hanging
in weights
270 mm

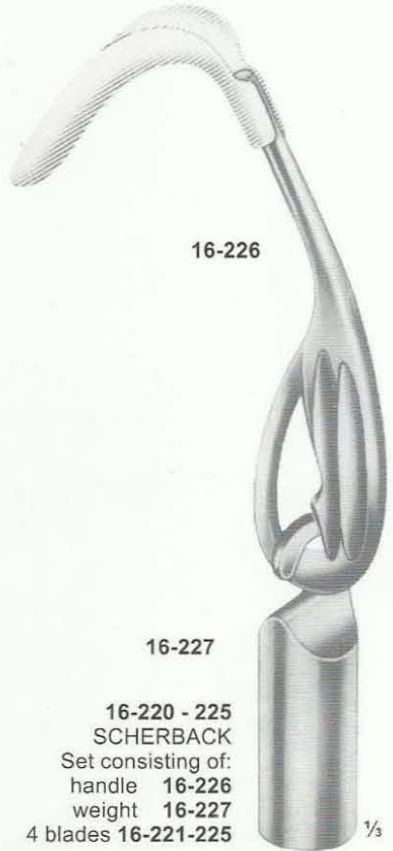

16-220 - 225
SCHERBACK
Set consisting of:
handle 16-226
weight 16-227
4 blades 16-221-225

The mentioned blades (16-221 - 225 and 16-229 - 236) can be exchanged. They fit handle (16-226), as well as handles (16-237 and 16-238).



16-228
BOZEMANN
Set consisting of:
2 handle (16-237 - 238)
8 blades (16-229 - 236)

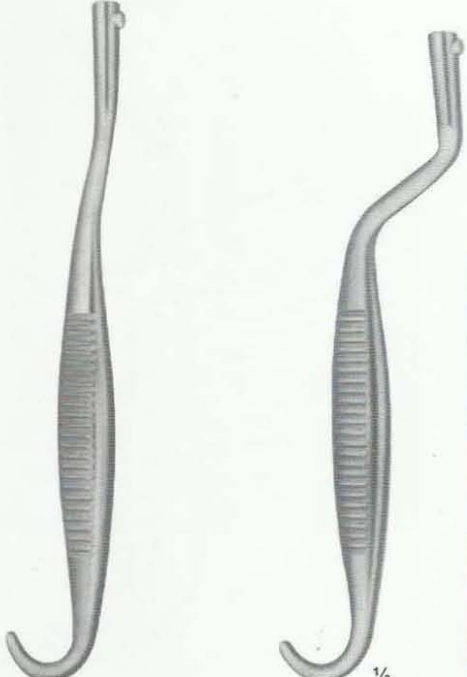



ST-MARKS
16-239

ST-MARKS
16-240
32.5 cm / 13"

ST-MARKS
16-241
32.5 cm / 13"

THROKSON

- 33 cm
- 16-242** 40 x 170 mm
- 16-242A** 50 x 170 mm
- 16-242B** 65 x 170 mm
with holes
- 16-242C** 40 x 170 mm
- 16-242D** 50 x 170 mm
- 16-242E** 65 x 170 mm
with 3 slots



17-101	1	mm	17-123	23	mm
17-102	2	mm	17-124	24	mm
17-103	3	mm	17-125	25	mm
17-104	4	mm	17-126	26	mm
17-105	5	mm	17-127	1	½mm
17-106	6	mm	17-128	2	½mm
17-107	7	mm	17-129	3	½mm
17-108	8	mm	17-130	4	½mm
17-109	9	mm	17-131	5	½mm
17-110	10	mm	17-132	6	½mm
17-111	11	mm	17-133	7	½mm
17-112	12	mm	17-134	8	½mm
17-113	13	mm	17-135	9	½mm
17-114	14	mm	17-136	10	½mm
17-115	15	mm	17-137	11	½mm
17-116	16	mm	17-138	12	½mm
17-117	17	mm	17-139	13	½mm
17-118	18	mm	17-140	14	½mm
17-119	19	mm	17-141	15	½mm
17-120	20	mm	17-142	16	½mm
17-121	21	mm	17-143	17	½mm
17-122	22	mm			

½

17-101 - 143
HEGAR
with very conical point
185 mm



Set of 13 dilators

17-144	1/2	mm
17-145	3/4	mm
17-146	5/6	mm
17-147	7/8	mm
17-148	9/10	mm
17-149	11/12	mm
17-150	13/14	mm
17-151	15/16	mm
17-152	17/18	mm
17-152A	19/20	mm
17-152B	21/22	mm
17-152C	23/24	mm
17-152D	25/26	mm

Set Of 5 Dilators

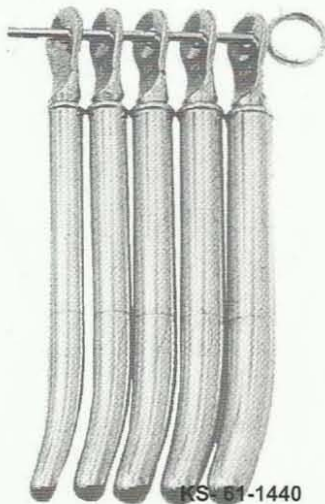

17-152-5



PRATT
17-153A
Double ended
26.5 cm

Set of 8, Sizes 13 through 43 French
 Sizes 13/15 French
 Sizes 17/19 French
 Sizes 21/23 French
 Sizes 25/27 French
 Sizes 29/31 French
 Sizes 33/35 French
 Sizes 37/39 French
 Sizes 41/43 French



17-153
HEGAR
Double ended
Uterine dilator set
with 8 dilators
20 cm

Available in canvas and synthetic pouch

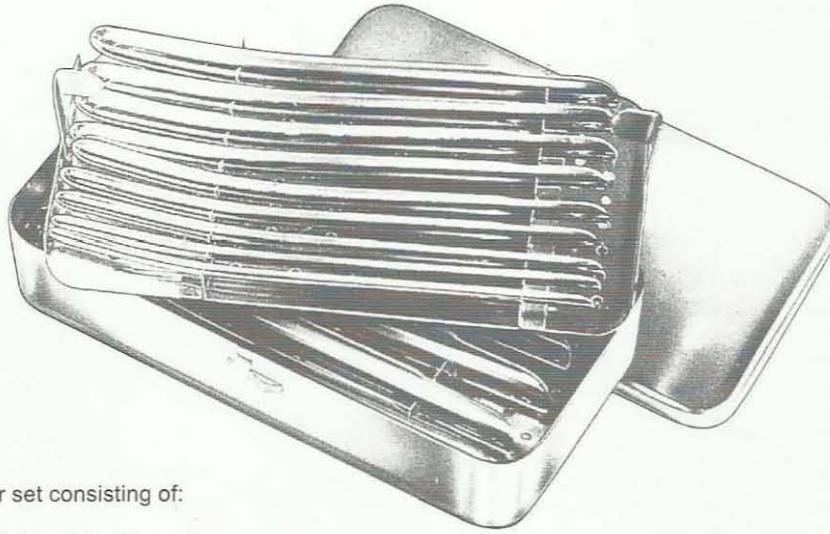

17-154
HEGAR
(17-104 - 117) Dilator set consisting of:
14 Dilators,
(17-155) 1 Rack for dilators (4 - 12 mm)
(17-156) 1 Rack for Dilators (13 - 17 mm)
(17-157) 1 Metal case only,
with hinged lid, stainless 200 X 100 X 35 mm

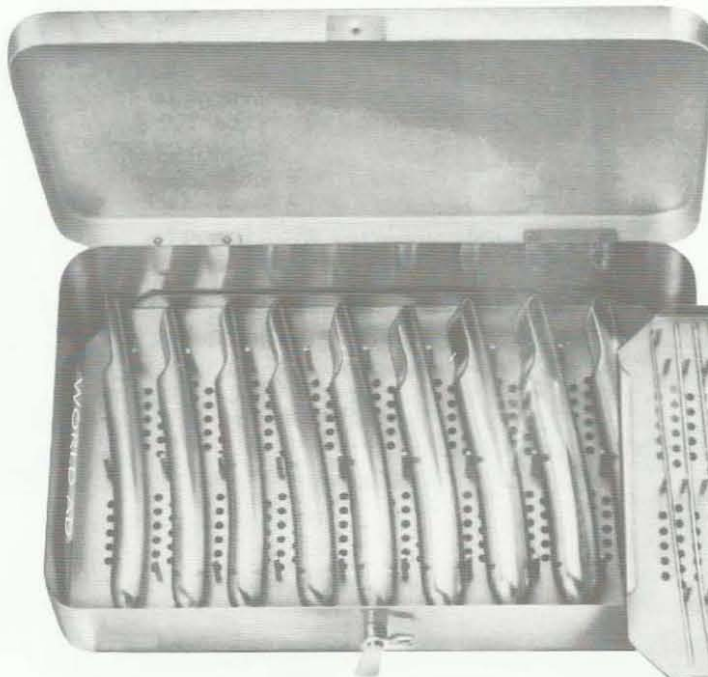

17-158
HEGAR
Dilator set consisting of:
26 Dilators, (17-101 - 126)
(17-159) 1 Rack for dilators (1 - 17 mm)
(17-160) 1 Rack for Dilators (18 - 26 mm)
(17-161) 1 Metal case only,
with hinged lid, of aluminium 330 X 220 X 80 mm

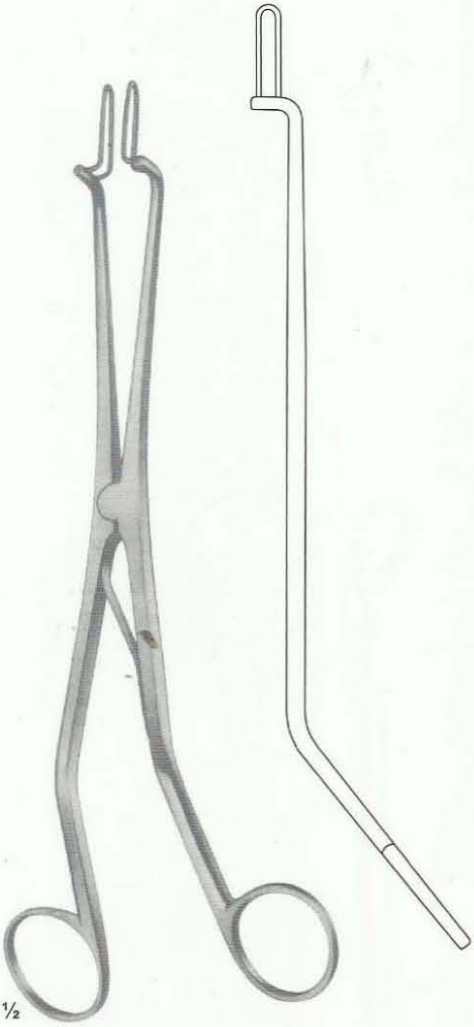

17-163
KOGAN
Endospecula for cervix
and urethra, without ratchet
240 mm

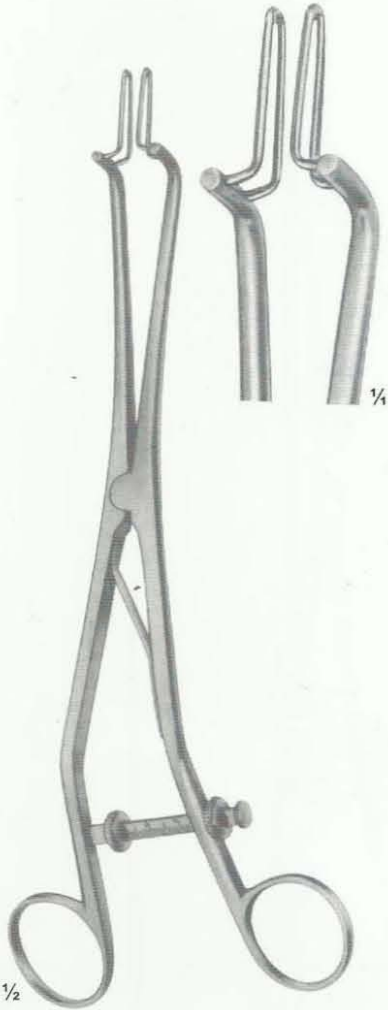

17-164
KOGAN
Endospecula for cervix
and urethra, with
scale-ratchet and fixing screws
240 mm

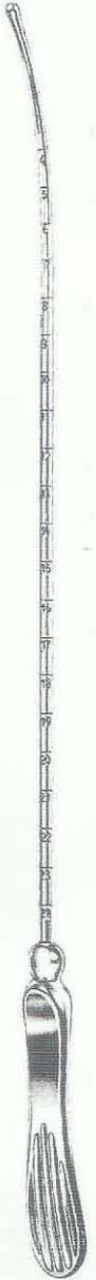

SIMS
18-101
32 cm
Malleable



18-102
32 cm
Malleable



18-103
Uterine probe



VALLEIX
18-104



BRAUN
18-105

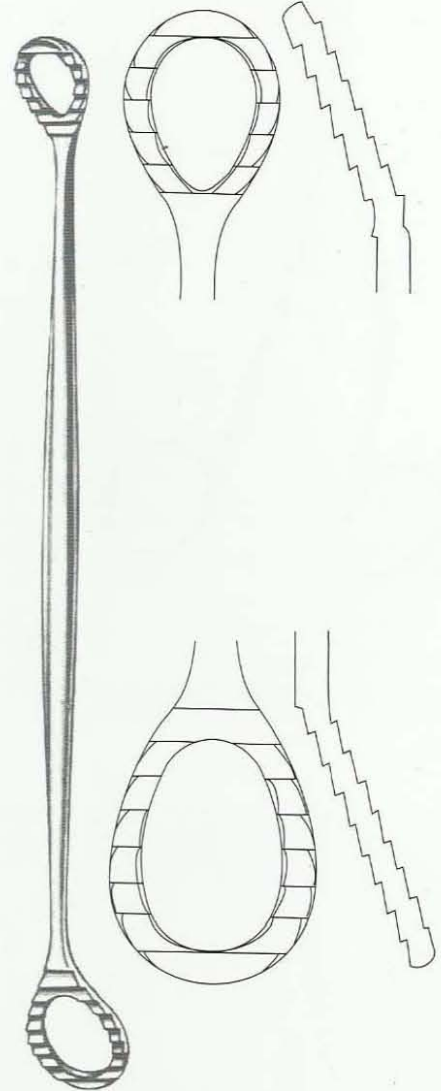

SIMS
18-106

28 mm

18-107
Cotton applicator
270 mm
1/2



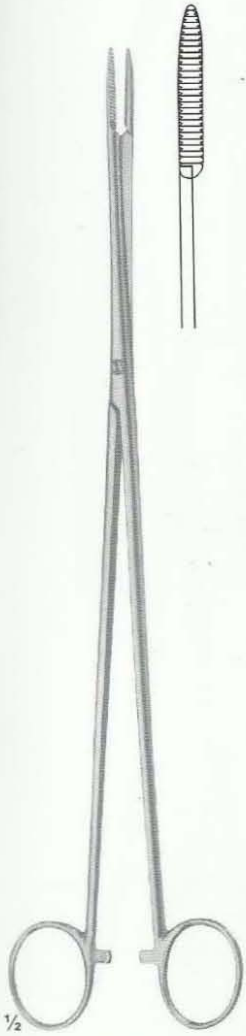

18-108
PELKMANN
260 mm



18-109
PELKMANN
260 mm

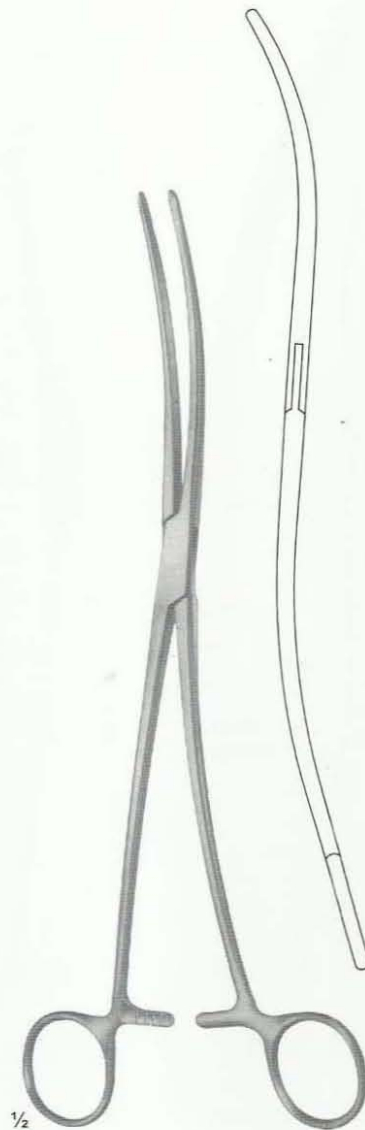

18-110
BOZEMANN
250 mm

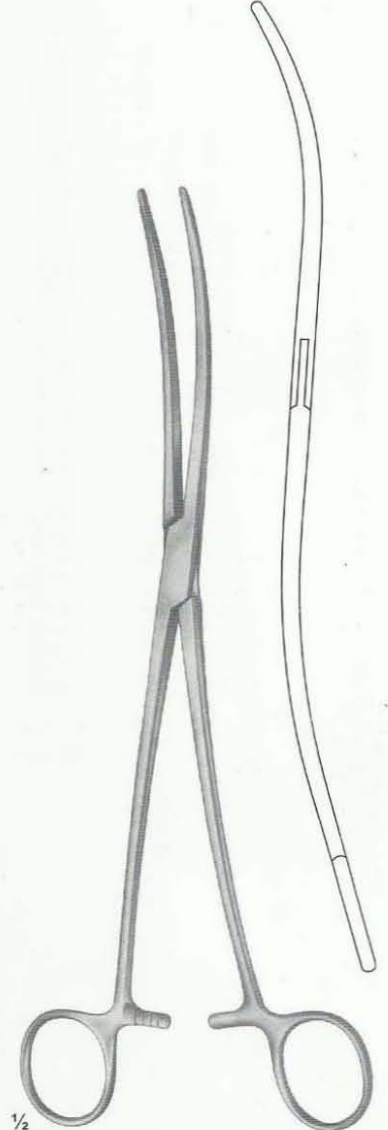

18-111
BOZEMANN
255 mm

Jaws with longitudinal groove

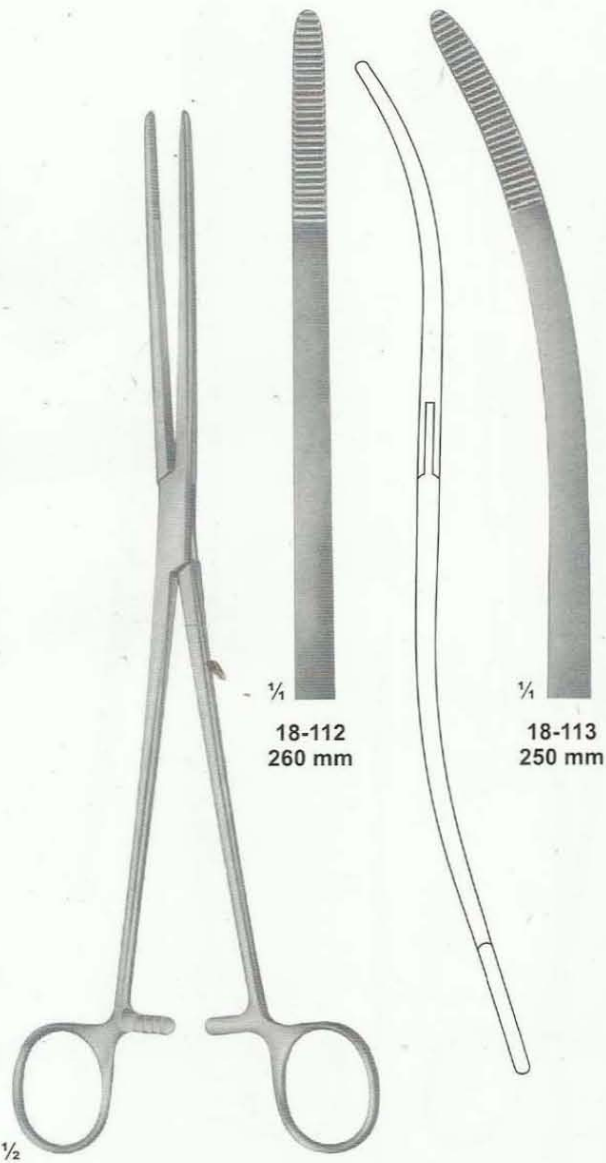

18-112
260 mm

18-113
250 mm

18-112 - 113
BOZEMANN

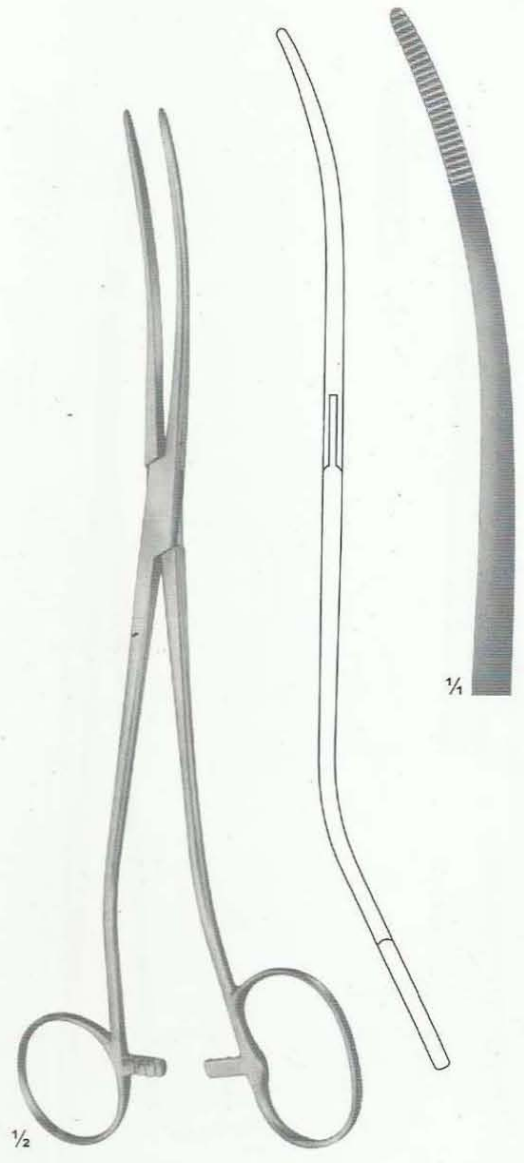

18-114
BOZEMANN-DOUGLAS
260 mm

Standard

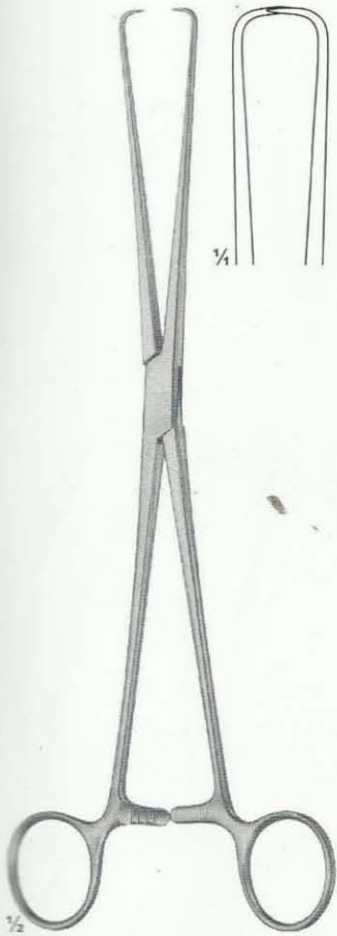

18-115
BRAUN
slender type
250 mm

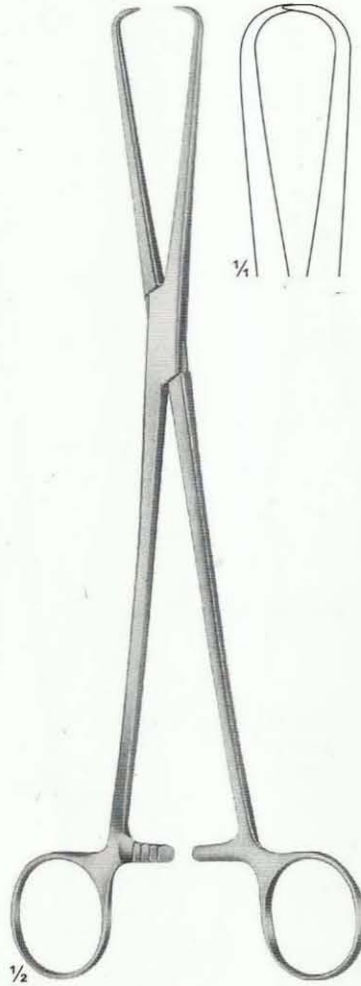

18-116
SCHROEDER
250 mm



18-117
POZZI
heavy type
255 mm

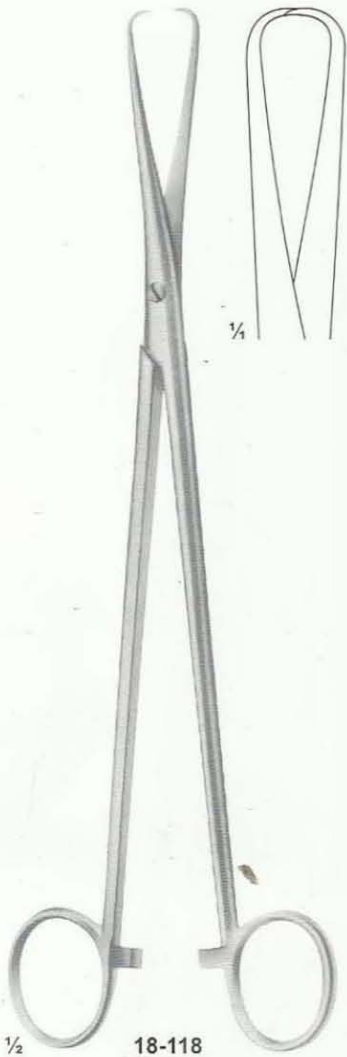

**18-118
MARTIN**
265 mm

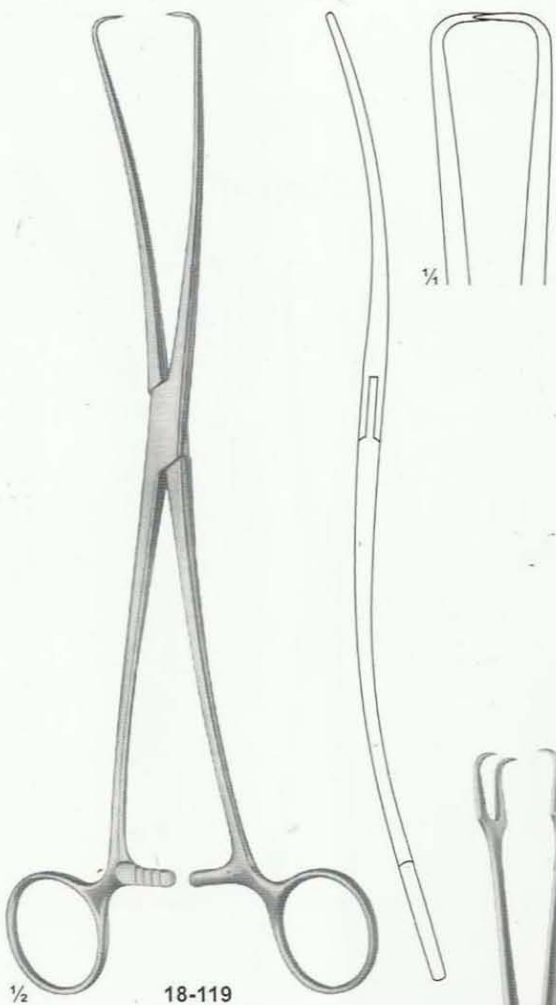

**18-119
DUPLAY**
250 mm

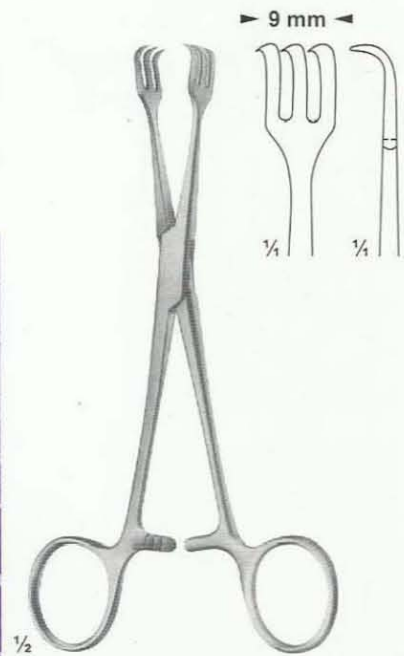
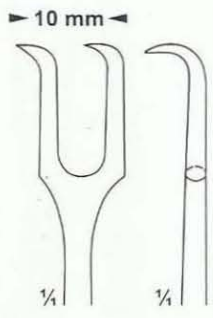

**18-120
LAHEY**
155 mm

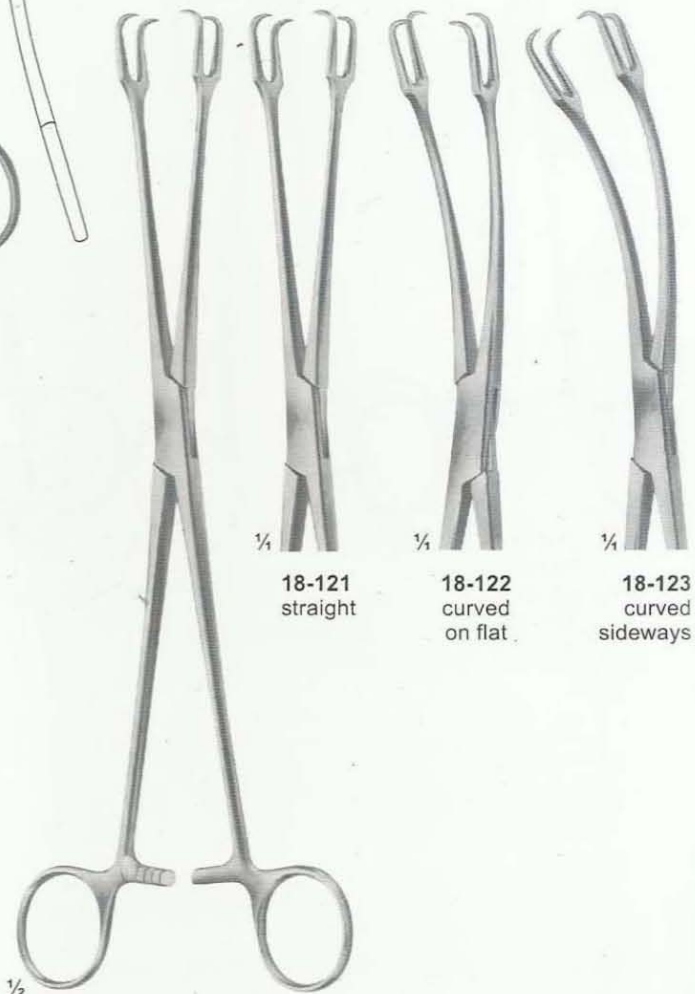

18-121
straight

18-122
curved
on flat

18-123
curved
sideways

**18-121 - 123
SCHROEDER**
250 mm

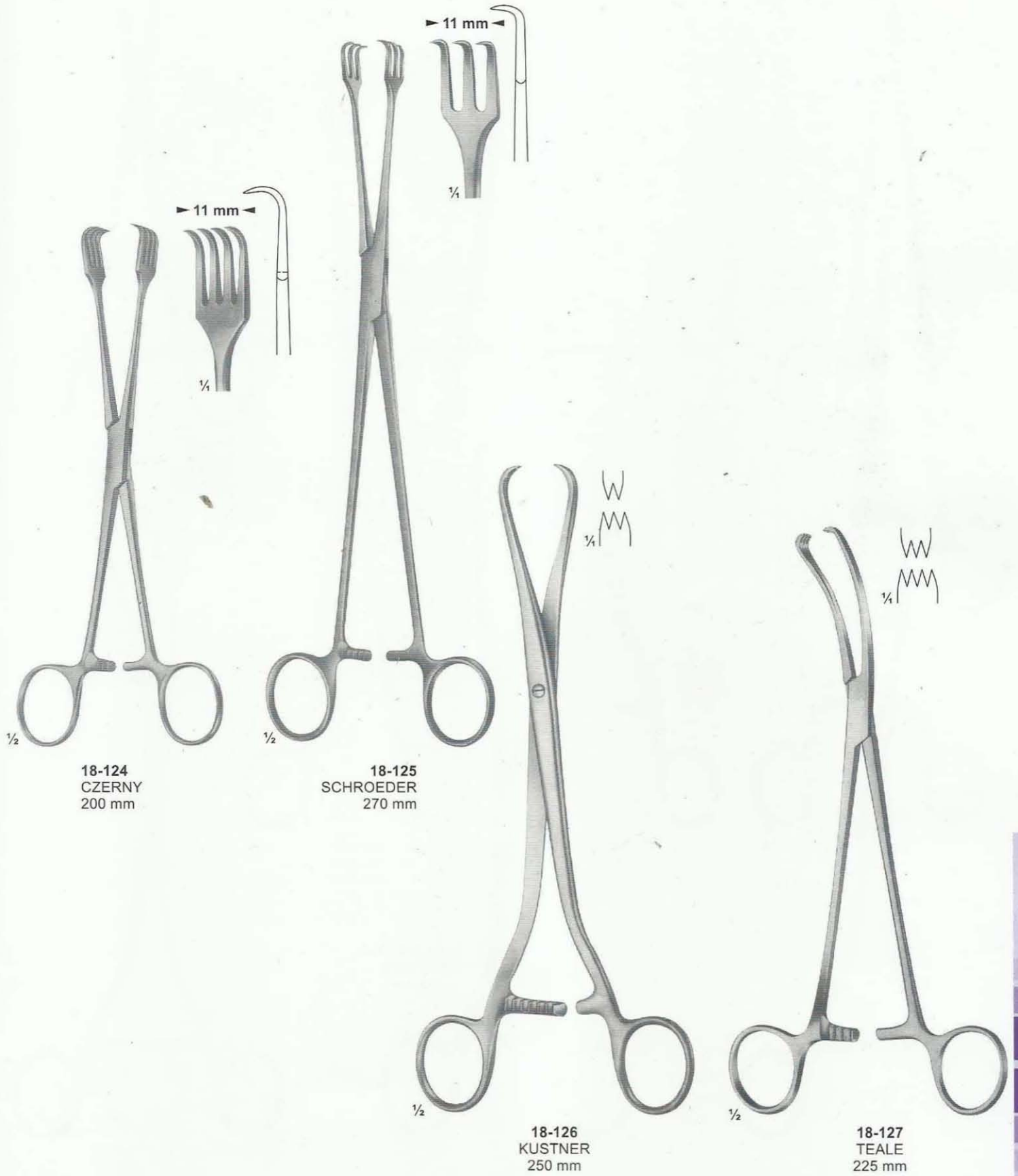

1/2
18-124
CZERNY
200 mm

1/2
18-125
SCHROEDER
270 mm

1/2
18-126
KUSTNER
250 mm

1/2
18-127
TEALE
225 mm

Uterine Tenaculum Forceps

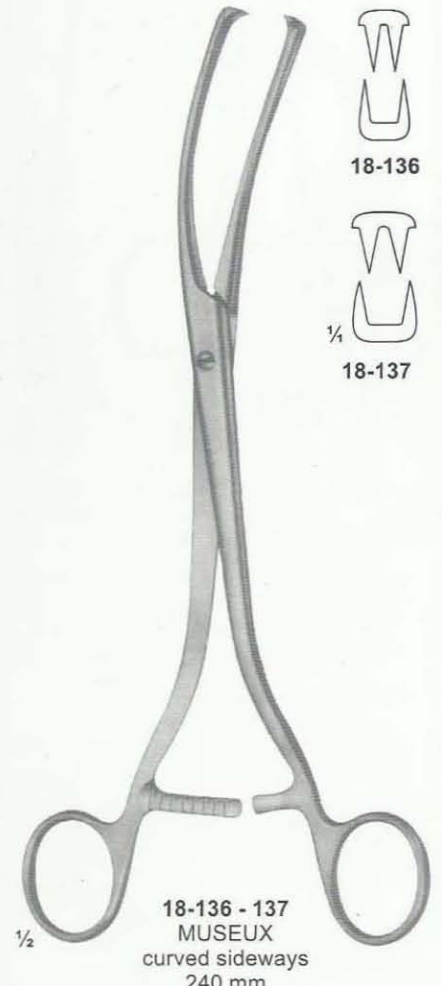
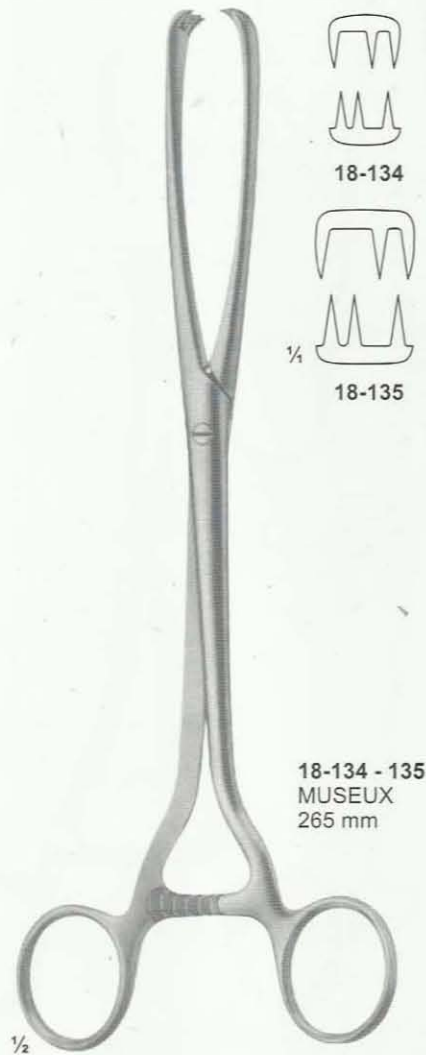
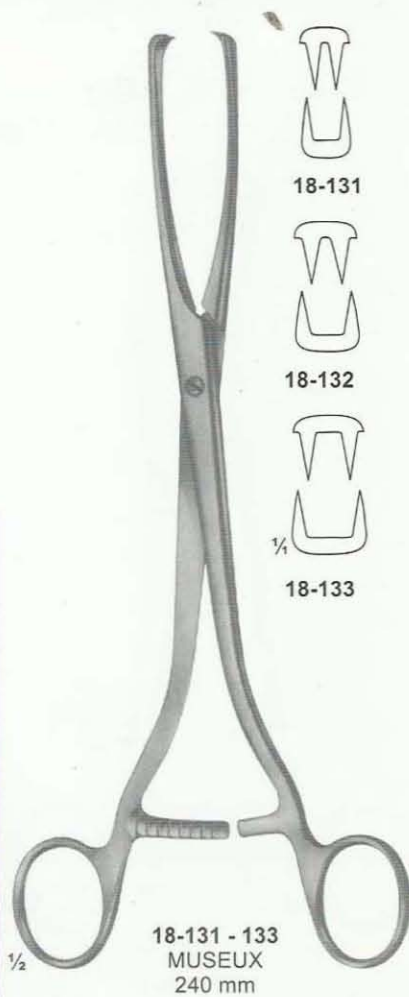

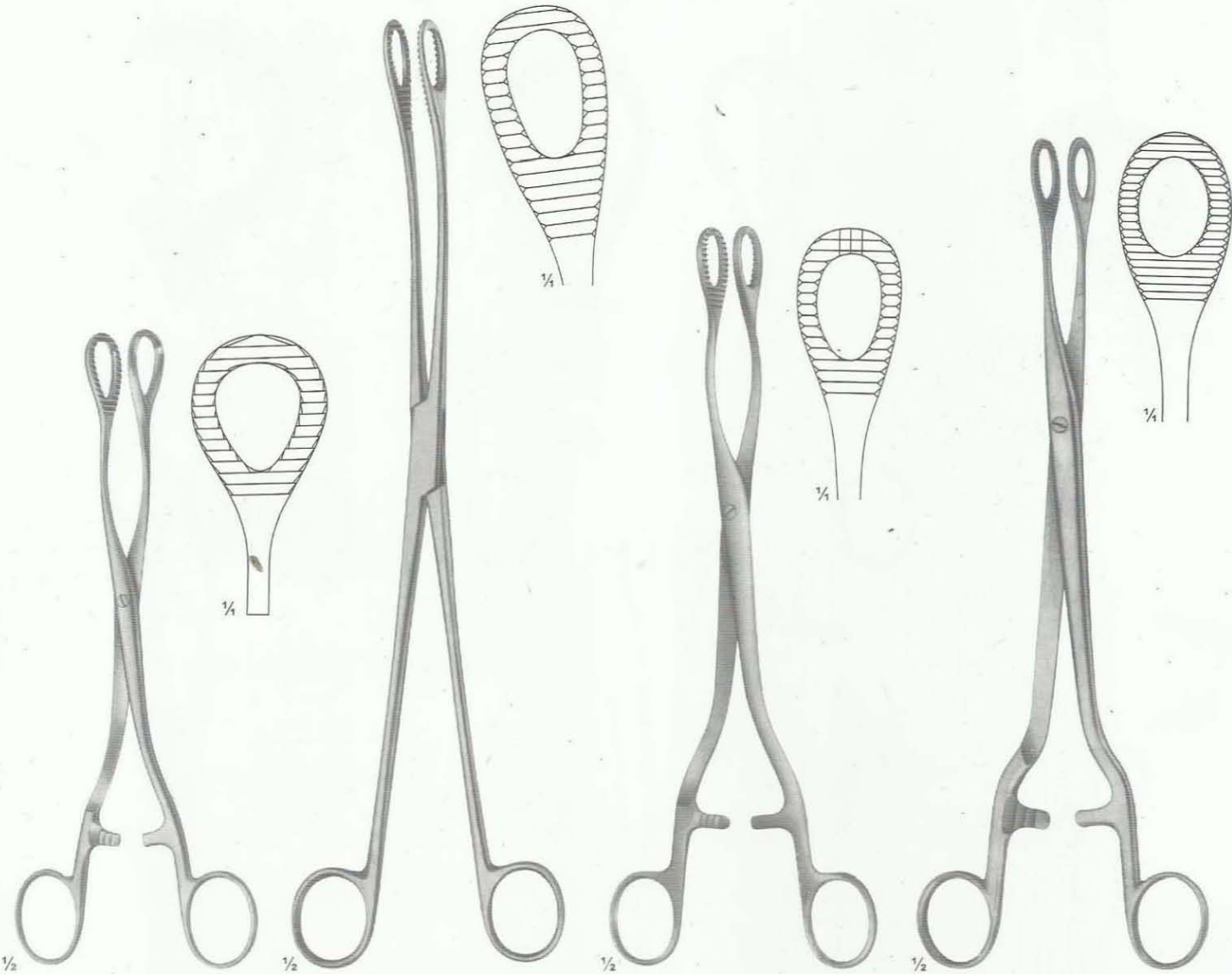

1/2
18-138
HEYWOOD-SMITH
200 mm

1/2
18-139
KELLY
320 mm

1/2
18-140
HEYWOOD-SMITH
250 mm

1/2
18-141
NOTO
280 mm

Atraumata



1/4



1/4

18-143
250mm

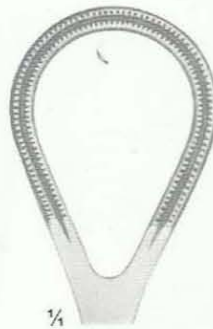

1/4

18-144
270mm



1/4

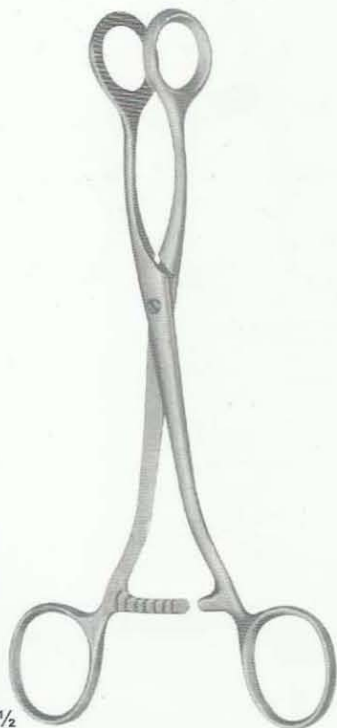

1/2

18-142
DOYEN

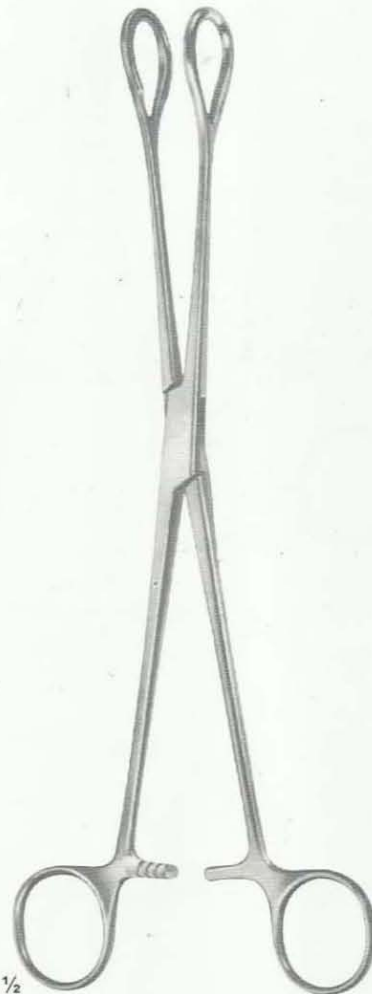

1/2

18-143 - 144

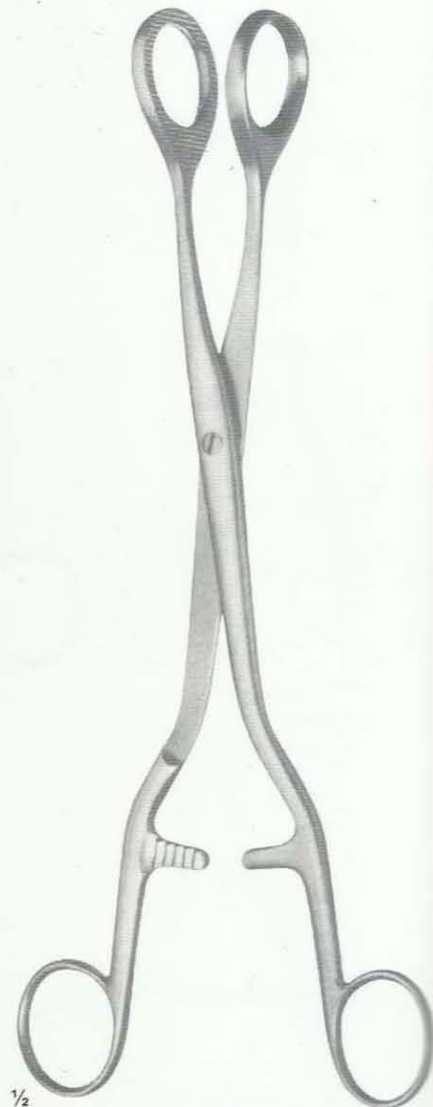

1/2

18-145
BUMM

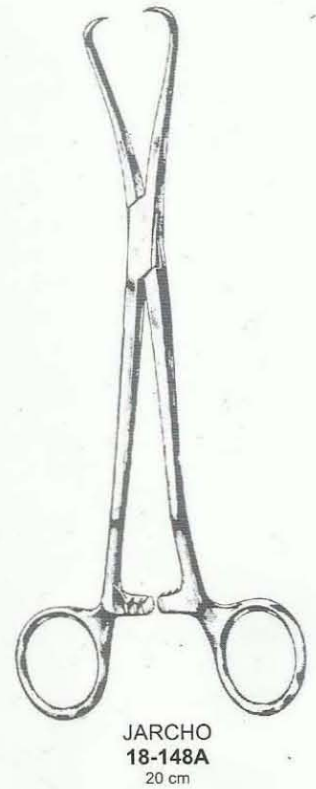
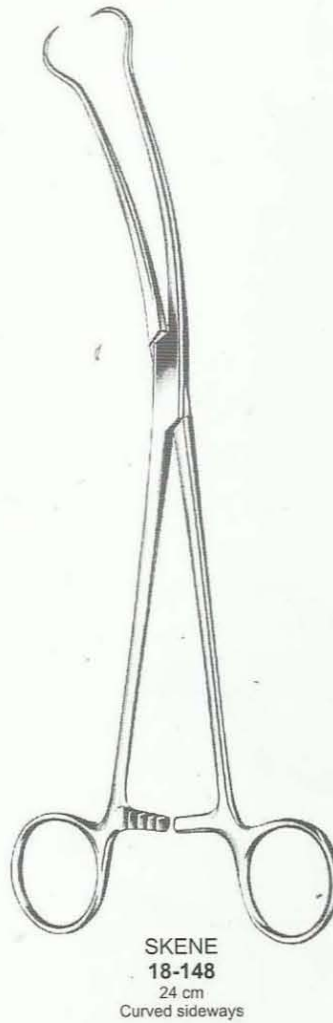
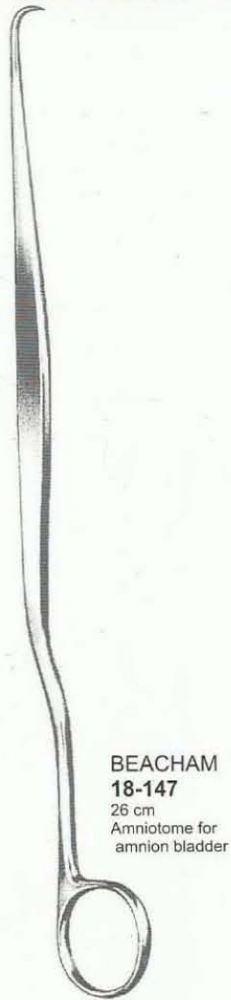

Uterine Dilating Forceps

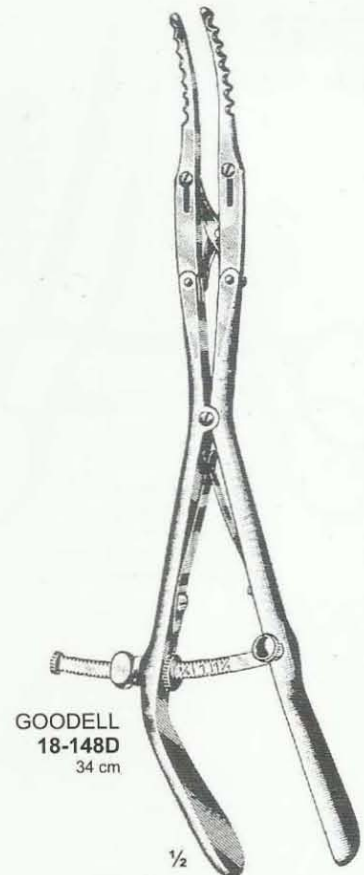
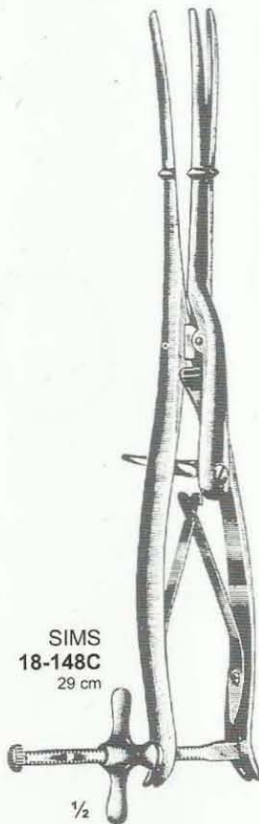
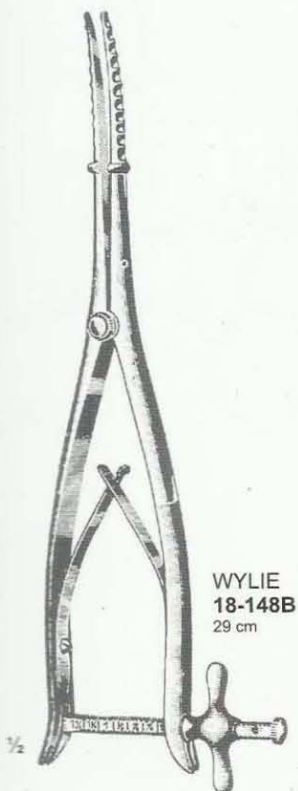

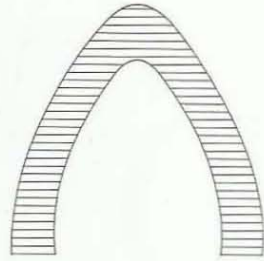

SOMER
235 mm



STRASSMANN
265 mm

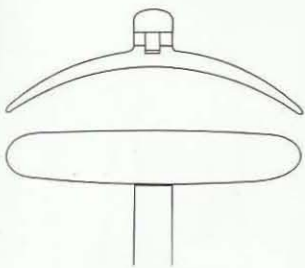

With movable jaws

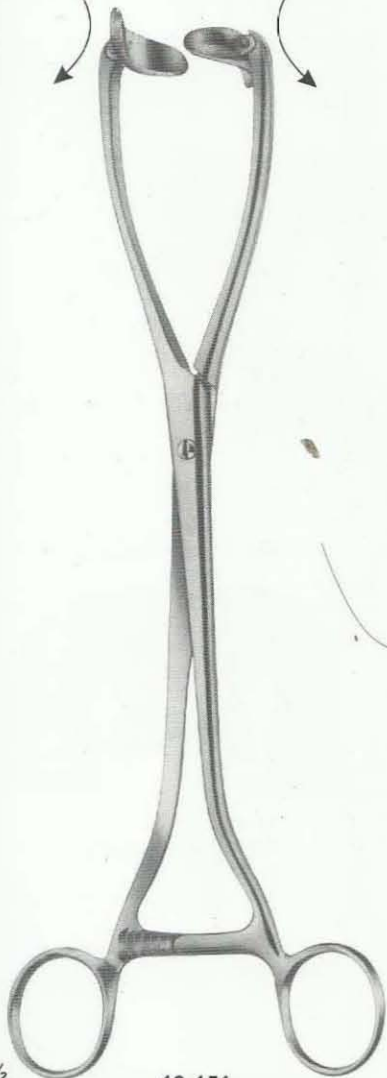

1/2

18-151
COLLIN
265 mm

With movable jaws



1/2

18-152
APPREX
approx. 260 mm



18-153
SEGOND
 Myomatome
 270 mm



18-154
DOYEN
 Myoma screw
 150 mm



18-155
DOYEN
 Myoma screw
 190 mm

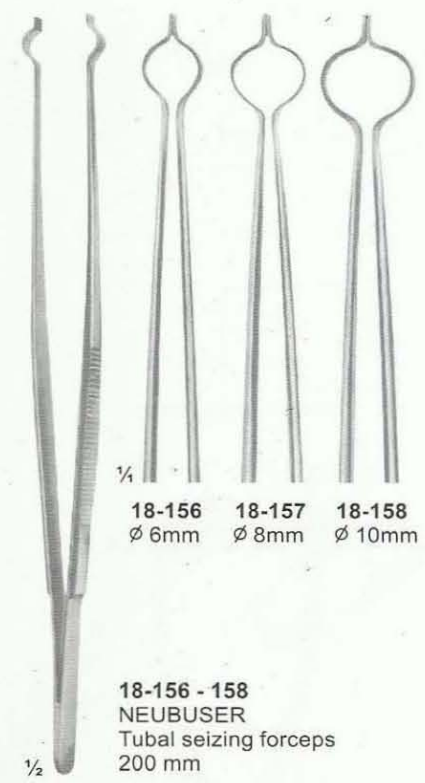

18-156 **18-157** **18-158**
 Ø 6mm Ø 8mm Ø 10mm

18-156 - 158
NEUBUSER
 Tubal seizing forceps
 200 mm



18-159
 Splint guide
 with thread



18-160
 Splint guide with
 round handle
 180 mm

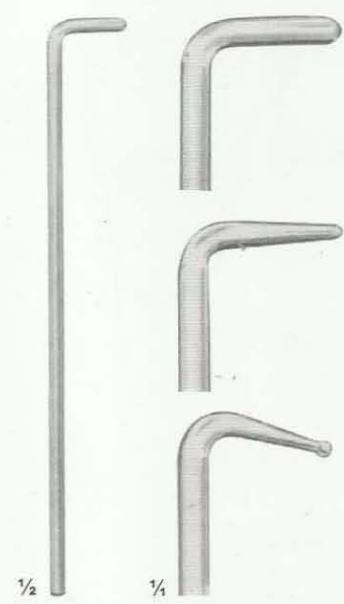

18-161
 Angled glass rods
 Set . 3 pieces

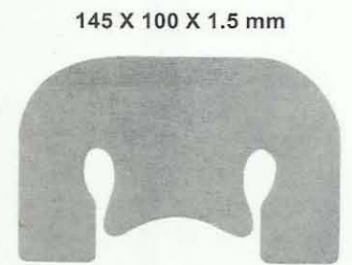

18-162
 Silicon operating pad
 pre-cut

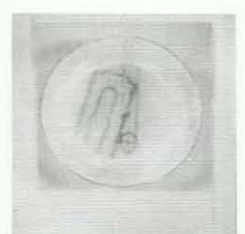

18-163
 Polyethylene splint material
 soft-sterile
 0.45 mm

	SECTION	PAGE
Biopsy	19	237-245
Instruments		
Obstetrics	20	246-254

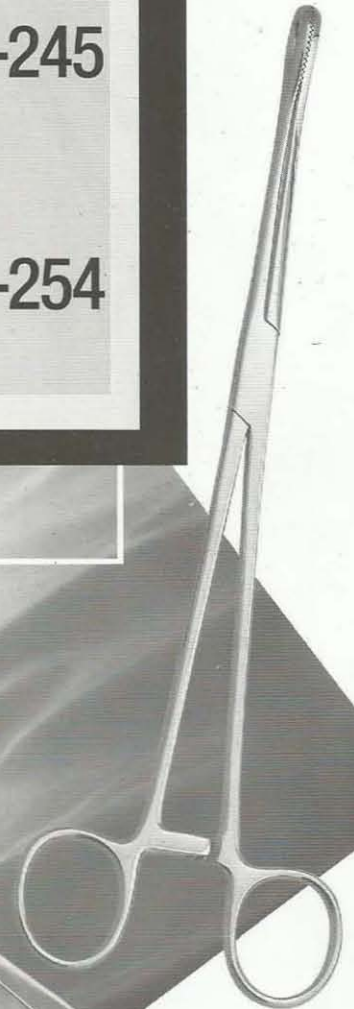
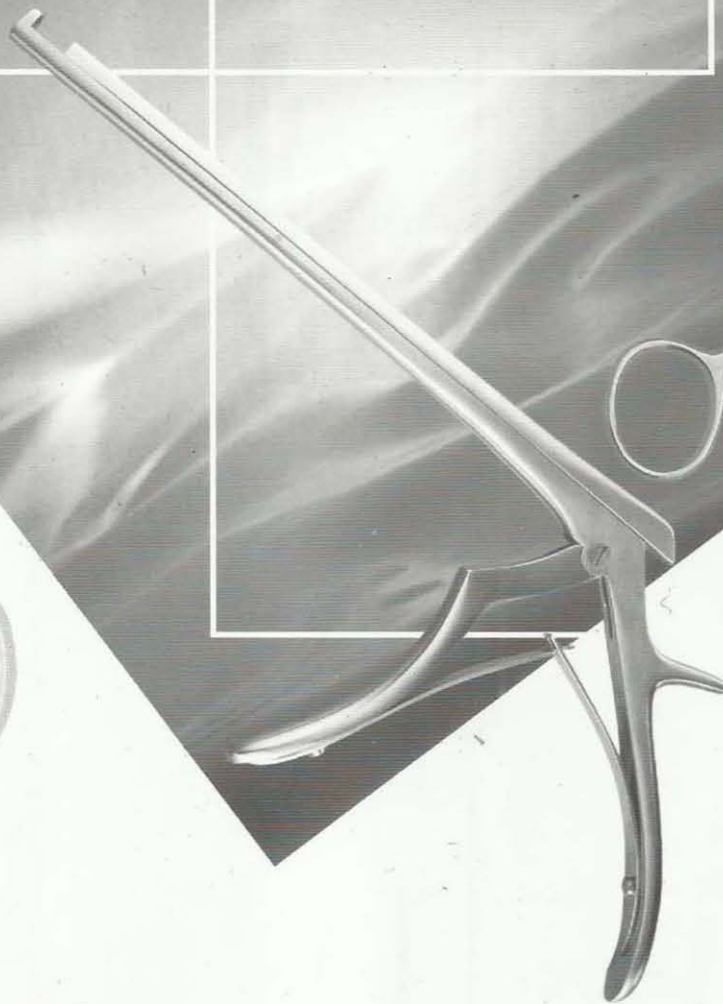
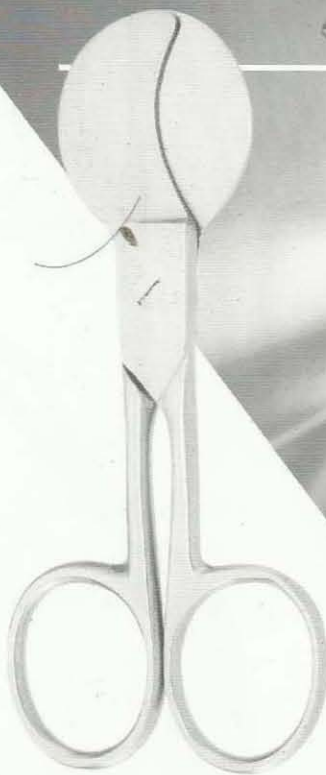

Malleable



19-101
ASCH
Uterine
Secretion scoop
200 mm

Malleable



19-102
MOD. MUENCHEN
UTERINE
Secretion scoop
270 mm

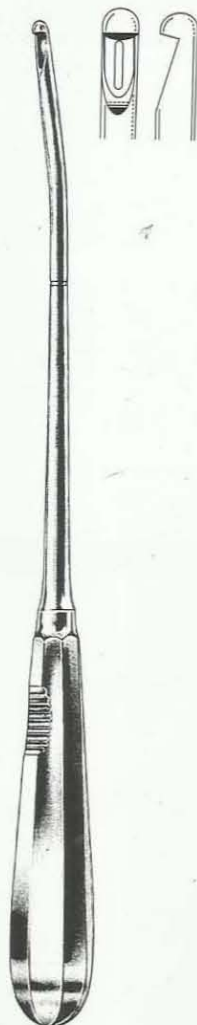

MOD. MUENCHEN
19-102A
27 cm
4.8 mm Ø

19-103A
Without basket



19-103B
With basket



KEVORKIAN
30 cm / 12"



Luer-Lock



19-103
NOVAK-SCHOECKAERT
Endometrial biopsy
curette
240 mm

Luer-Lock



19-104
RANDALL
Endometrial
biopsy curette
240 mm

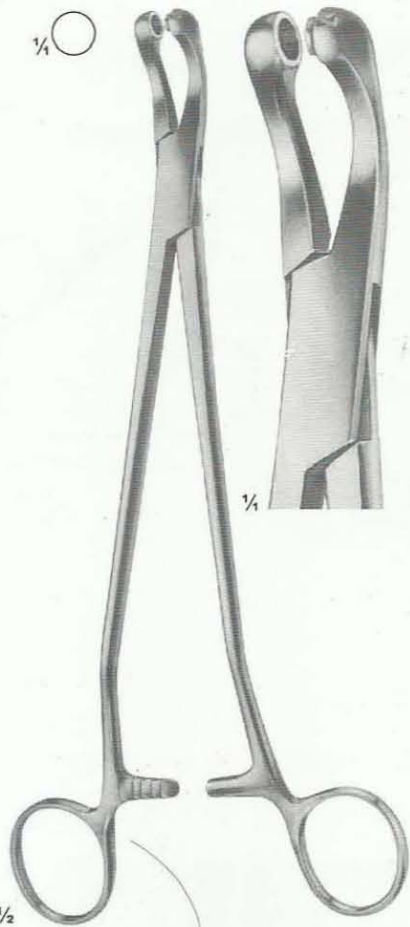

19-105
THOMS-GAYLOR
240 mm

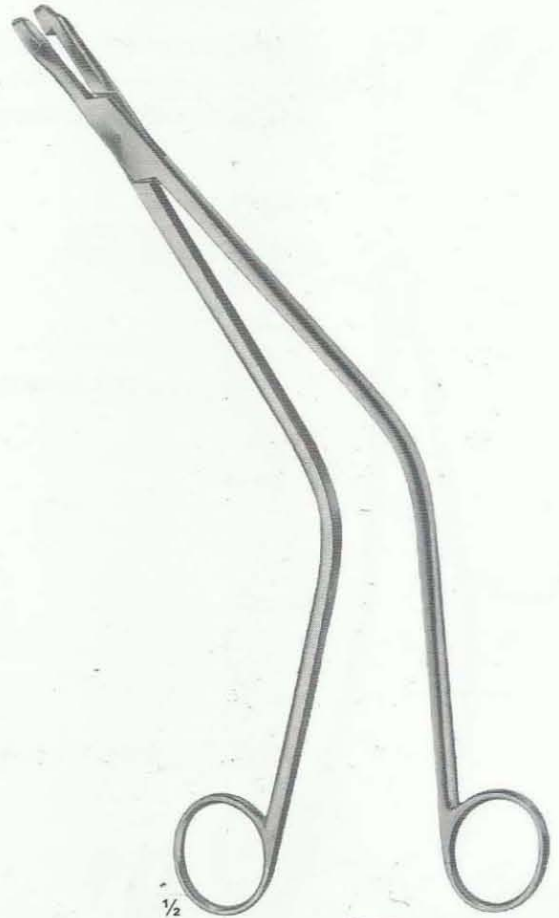

19-106
SCHUBERT
260 mm



19-107
FAURE
210 mm

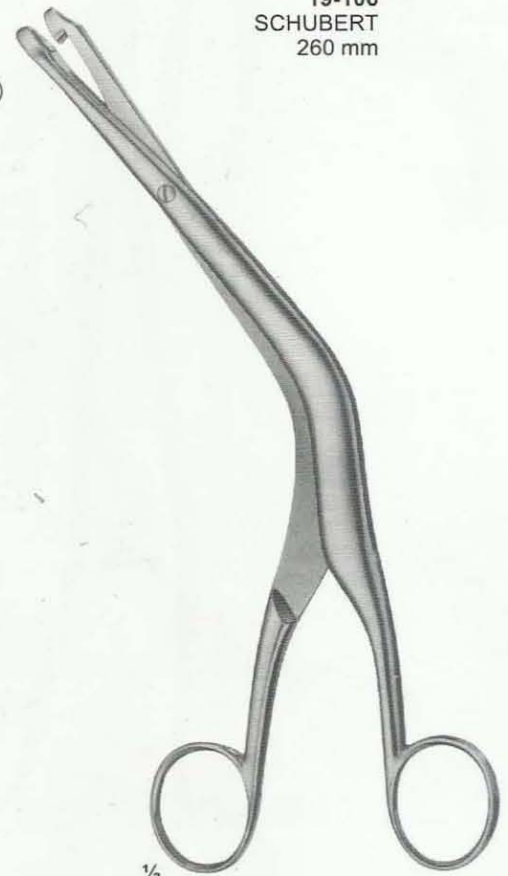

19-108
FAURE
240 mm

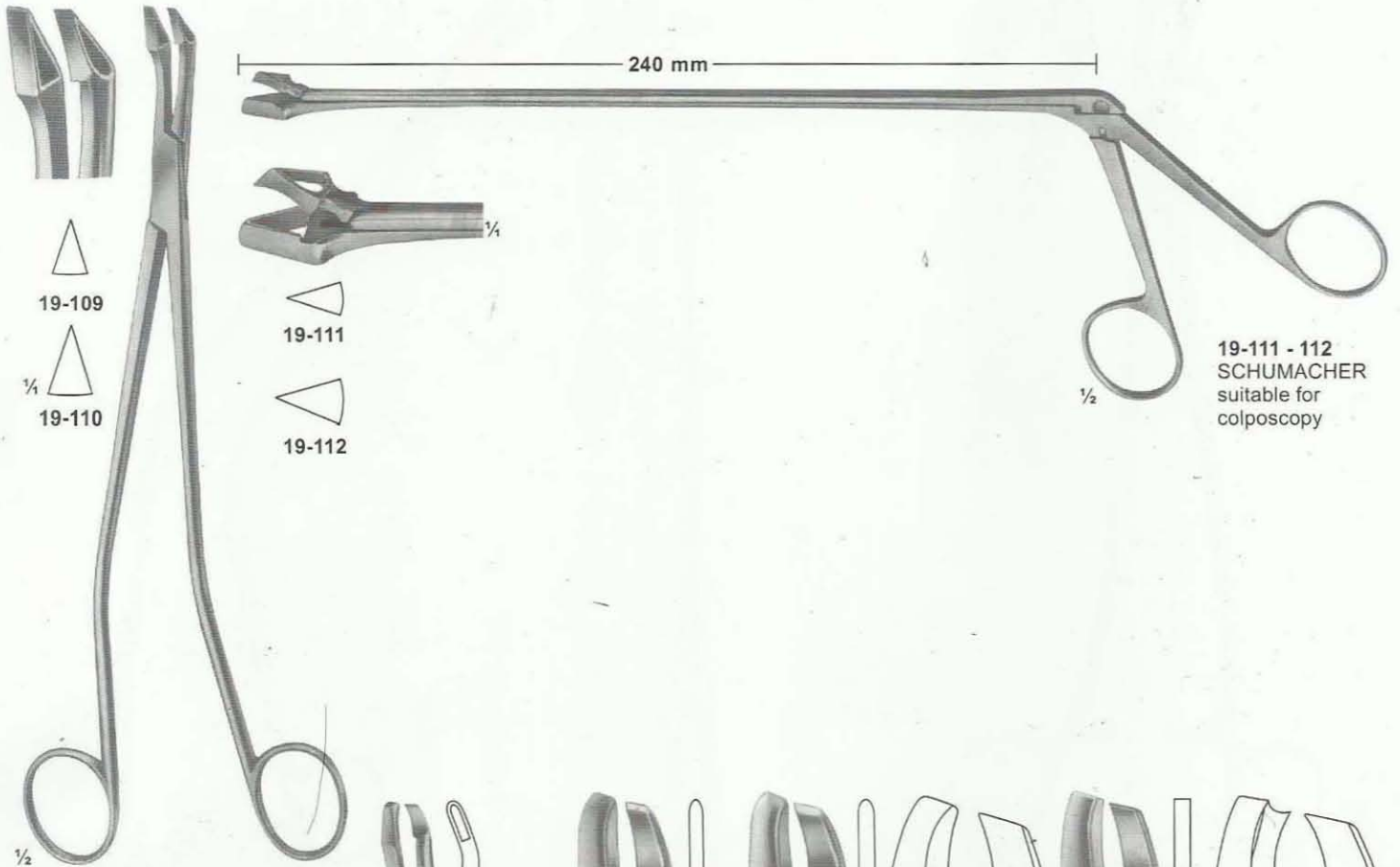

19-109

19-110

19-111

19-112

19-111 - 112
SCHUMACHER
suitable for
colposcopy

19-109 - 110
SCHUMACHER
240mm

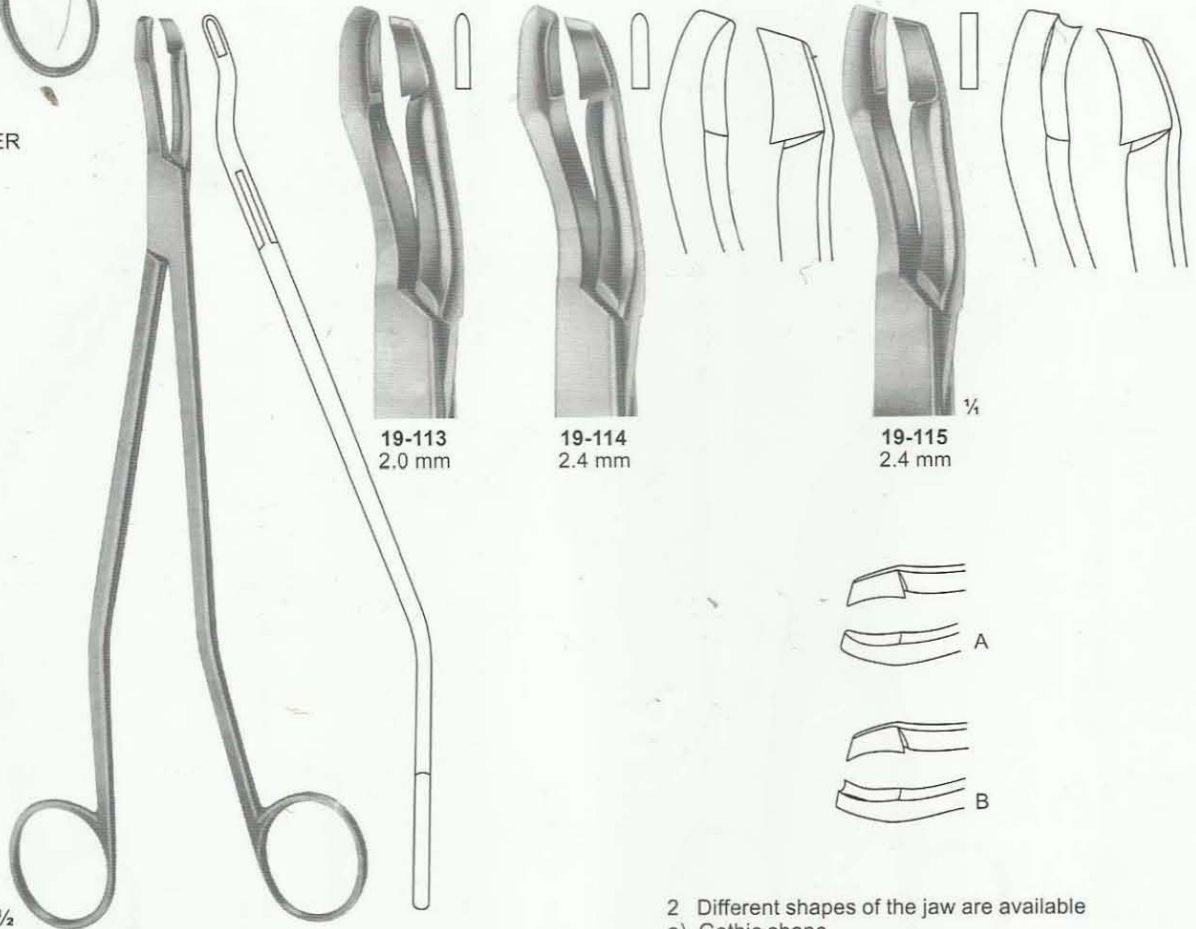

19-113
2.0 mm

19-114
2.4 mm

19-115
2.4 mm

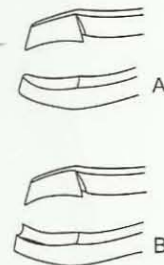

2 Different shapes of the jaw are available
a) Gothic shape
2.0 resp 2.4mm wide (causes less bleeding)
b) Rectangular shape, 2.4mm wide

19-113 - 115
SEIDL DBP
Biopsy forceps, bayonet shaped
for portio, vagina and vulva
240mm

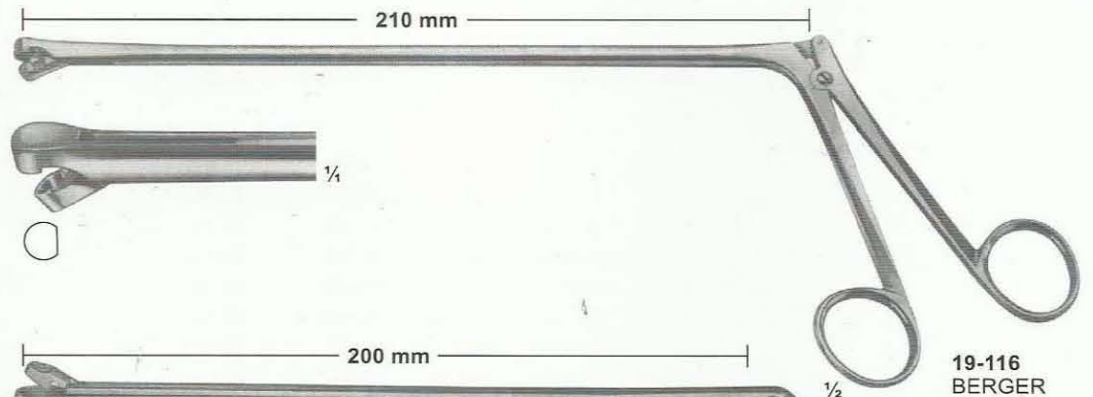

19-116 BERGER

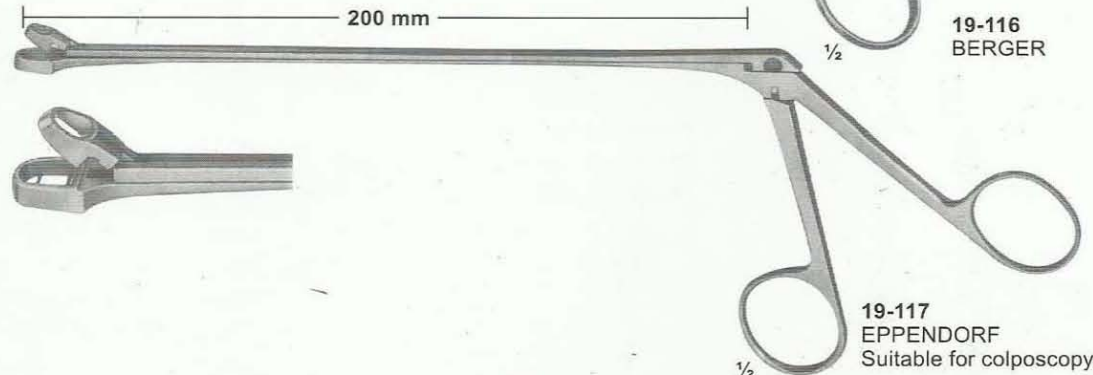

19-117 EPPENDORF Suitable for colposcopy

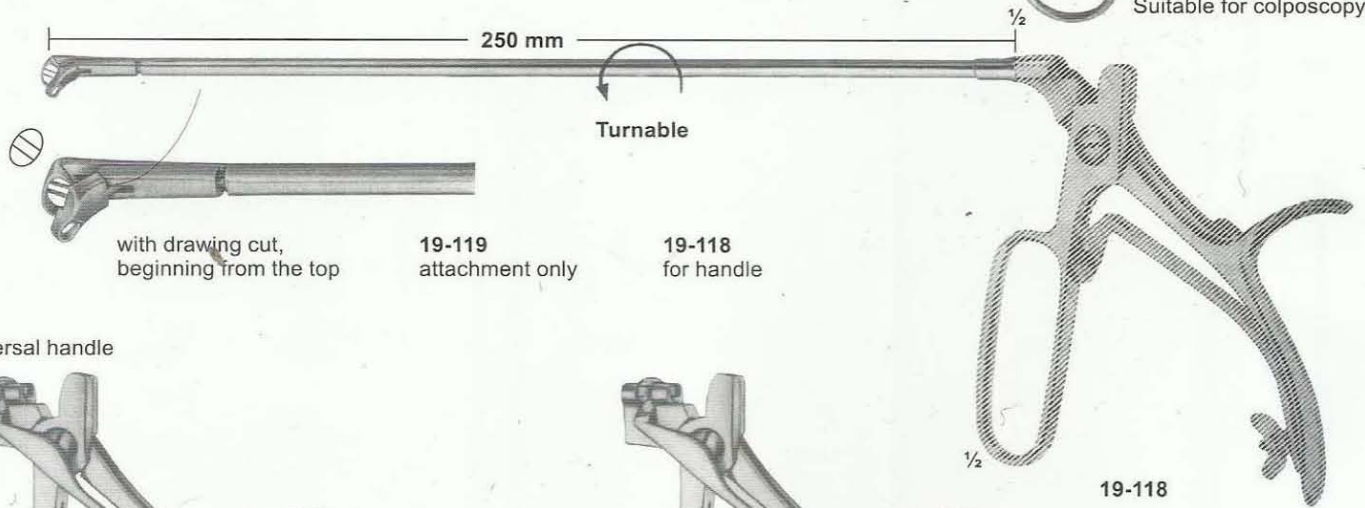

with drawing cut, beginning from the top

19-119 attachment only

19-118 for handle

19-118

universal handle

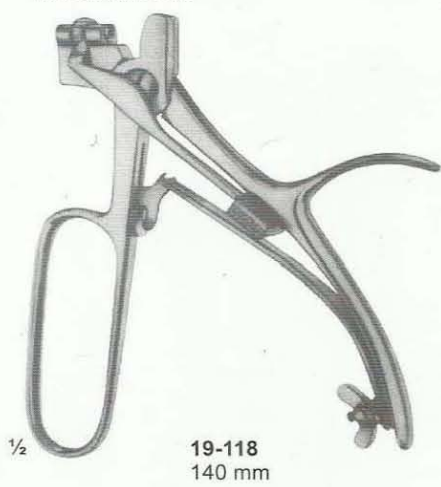

19-118 140 mm

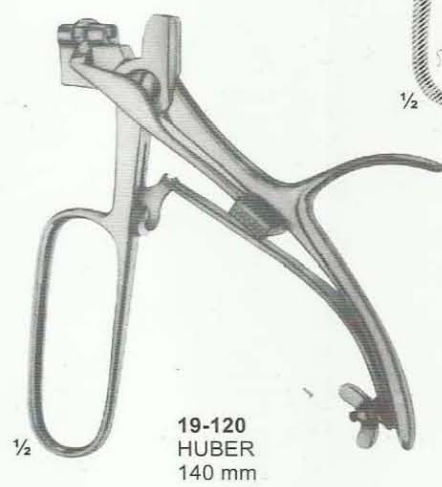

19-120 HUBER 140 mm

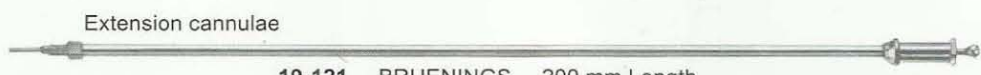

Extension cannulae

19-121 BRUENINGS 200 mm Length
19-122 BRUENINGS 250 mm Length



19-123 19-124

19-125 KRAUSE (Biopsy tip)



19-126 SCHEINMANN (Biopsy tip)

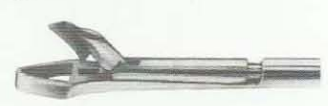

19-127 SCHUMACHER (Biopsy tip) with drawing cut

Uterine Scoops

Fig	Width	Sharp		Blunt
		Rigid	Malleable	Rigid
00	4.5mm	19.130		
0	7.5mm	19.131		19.142
1	8.5mm	19.132	19.153	19.143
2	10.5mm	19.133	19.154	19.144
3	12.0mm	19.134	19.155	19.145
4	14.0mm	19.135	19.156	19.146
5	15.0mm	19.136	19.157	19.147
6	16.5mm	19.137	19.158	19.148
7	18.0mm	19.138	19.159	19.149
8	19.5mm	19.139	19.160	19.150
9	21.5mm	19.140		19.151
10	23.5mm	19.141		19.152
19-130 - 19-141		Sharp - Rigid		
19-153 - 19-160		Sharp - Malleable		
19-142 - 15-152		Blunt - Rigid		

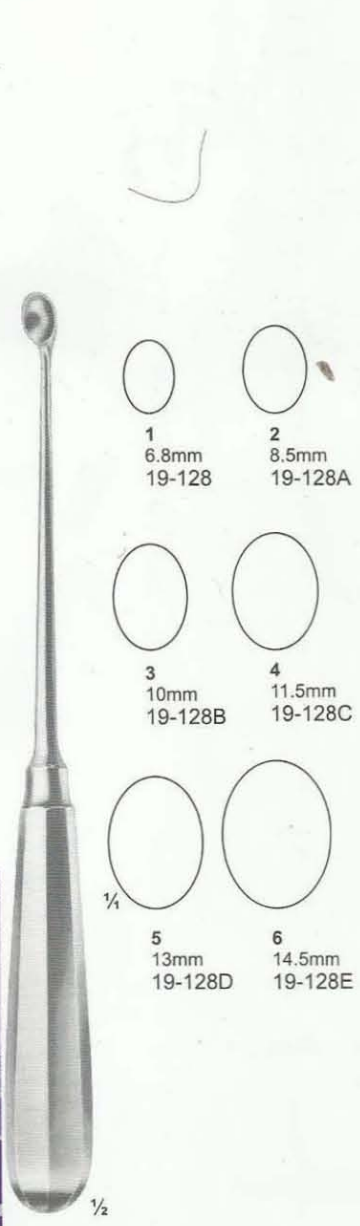

19-128 - 128E
SIMON
max.240 mm

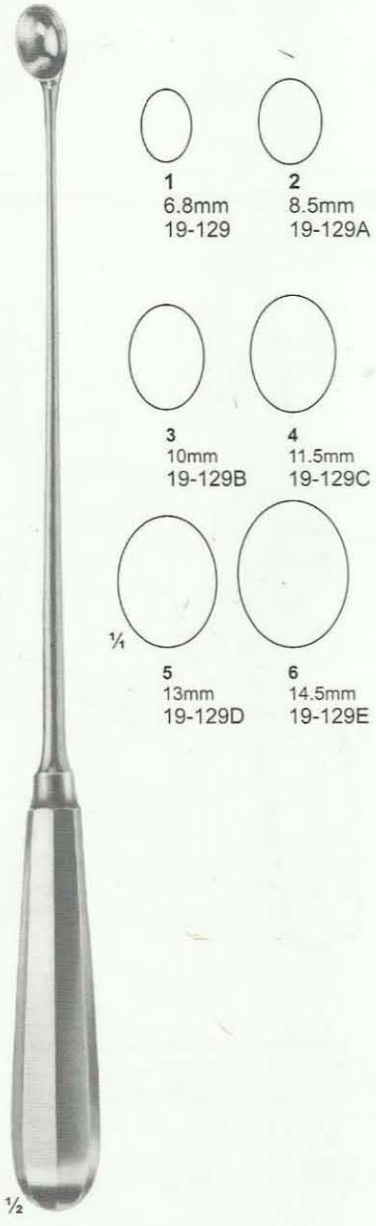

19-129 - 129A
SCHRODER
max.310 mm



19-130 - 160
RECAMIER
max.300 mm

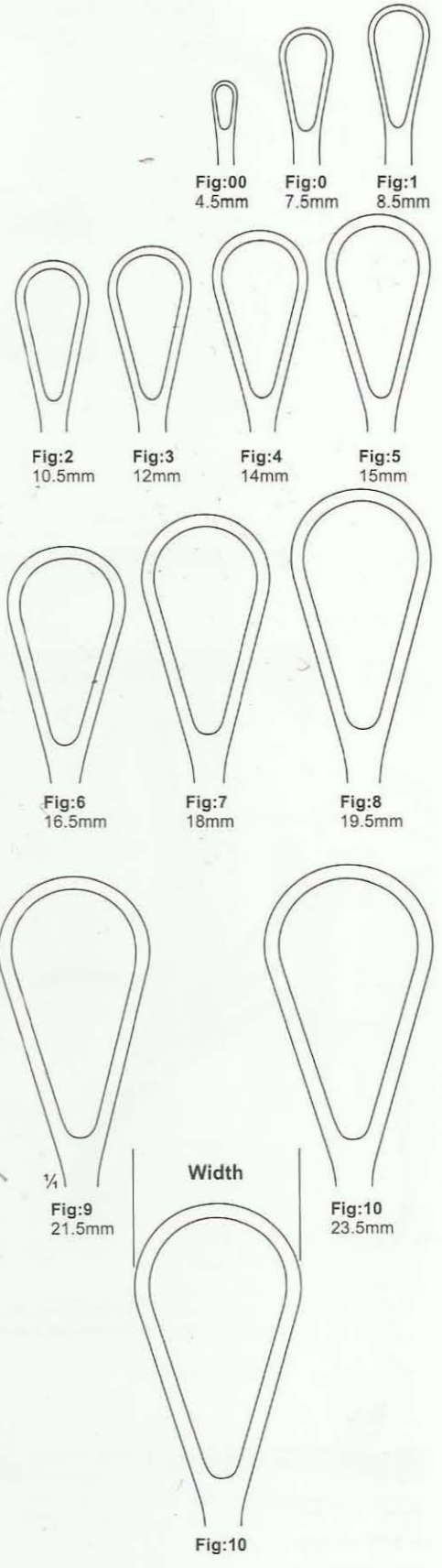

Fig	Width	Sharp		Blunt
		Rigid	Malleable	Rigid
1	7.5mm	19.161	19.167	19.173
2	8.5mm	19.162	19.168	19.174
3	10.5mm	19.163	19.169	19.175
4	12.0mm	19.164	19.170	19.176
5	14.0mm	19.165	19.171	19.177
6	15.0mm	19.166	19.172	19.178

19-161 - 19-136 Sharp - Rigid
 19-167 - 19-172 Sharp - Malleable
 19-173 - 19-178 Blunt - Rigid

Fig	Width	Blunt - Malleable
0	16.5mm	19.179
1	18.5mm	19.180
2	19.5mm	19.181
3	21.5mm	19.182
4	23.5mm	19.183
5	26.0mm	19.184
6	28.5mm	19.185

BUMM

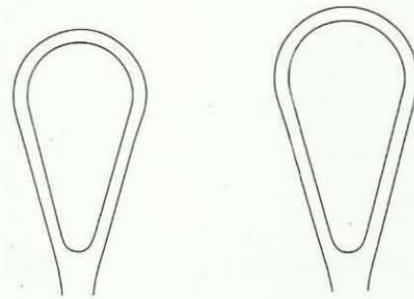

Fig:0
16.0mm

Fig:1
18.0mm

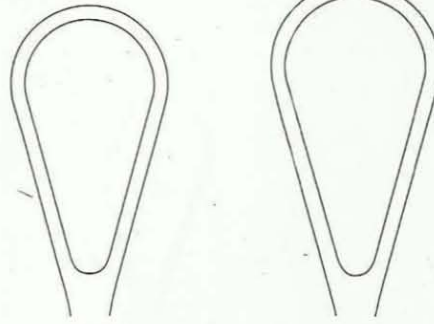

Fig:2
19.5mm

Fig:3
21.5mm

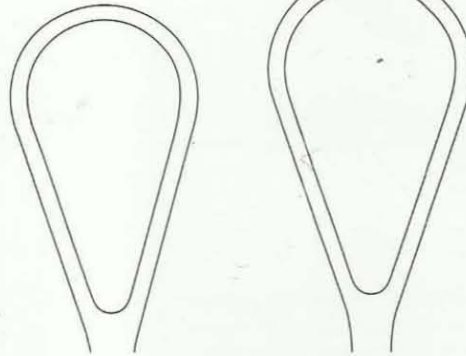

Fig:4
23.5mm

Fig:5
26.0mm

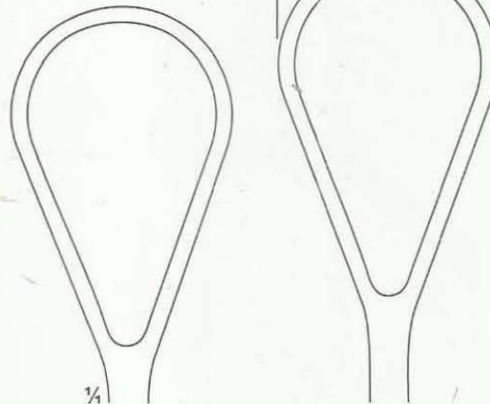
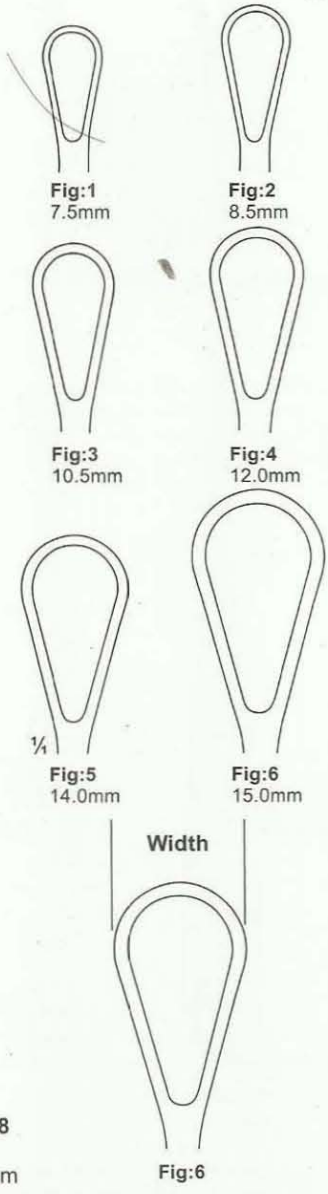

Fig:6
28.5mm

Fig:6



19-161 - 178
SIMS
max. 255 mm



19-179 - 185
BUMM
blunt-malleable
max. 290 mm



19-186
BLAKE
275 mm

Fig	Width	Sharp Malleable	Blunt Malleable
1	23.5mm	19.190	19.192
2	26.0mm		19.193
3	28.5mm	19.191	19.194



19-187
COLLIN
300 mm



19-188 - 189
RECAMIER
blunt-rigid
max. 360 mm

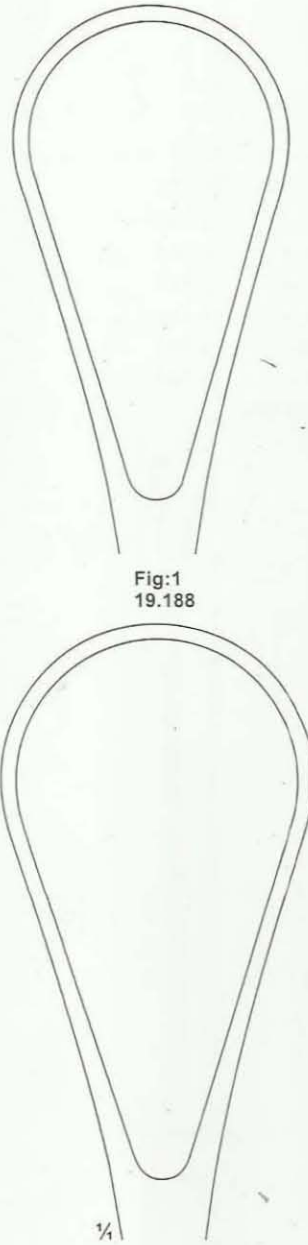

Fig:1
19.188

Fig:2
19.189



19-190 - 194
BUMM

max. 310 mm
19-190 - 191 sharp-malleable
19-192 - 194 blunt-malleable

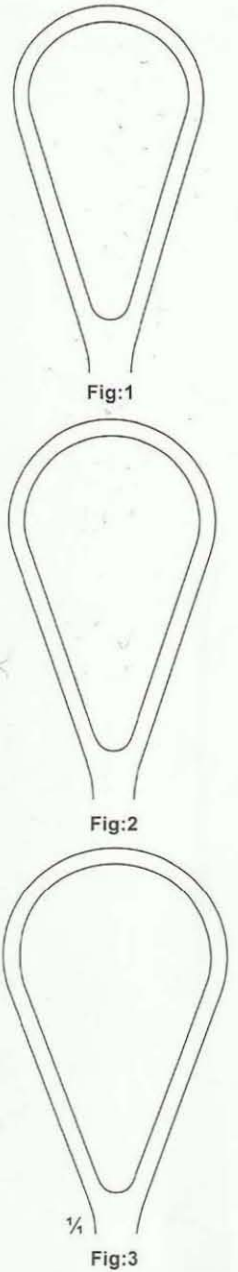

Fig:1

Fig:2

Fig:3

19-195 - 200

Suction curettes, stainless steel, fitting hose connection. (19-201)

Working tips are smoothly rounded off, therefore no danger of perforation.



(suitable for suction biopsy)

19-195: diam 4 mm

19-196: diam 6 mm

19-197: diam 8 mm

19-198: diam 10 mm

19-199: diam 12 mm

19-200: diam 14 mm

19-201

Hose connection inside diam. 11 mm, curved, stainless steel.



OLIVE
Ø 11.15mm

(19-195 - 19-200)

19-201



The new connection between suction curette and hose connection, (19-201) Guarantees quick changing and free turning of the suction curettes on the hose connection.

19-202

Transparent suction hose 1.8 m long, inside diam 11 mm, outside diam 16.5 mm can be sterilized in an autoclave at 1 bar overpressure (120° C)

19-202



19-203

Strainer for tissues, plastic, for single use only, to be used for histopathological examination.

19-203

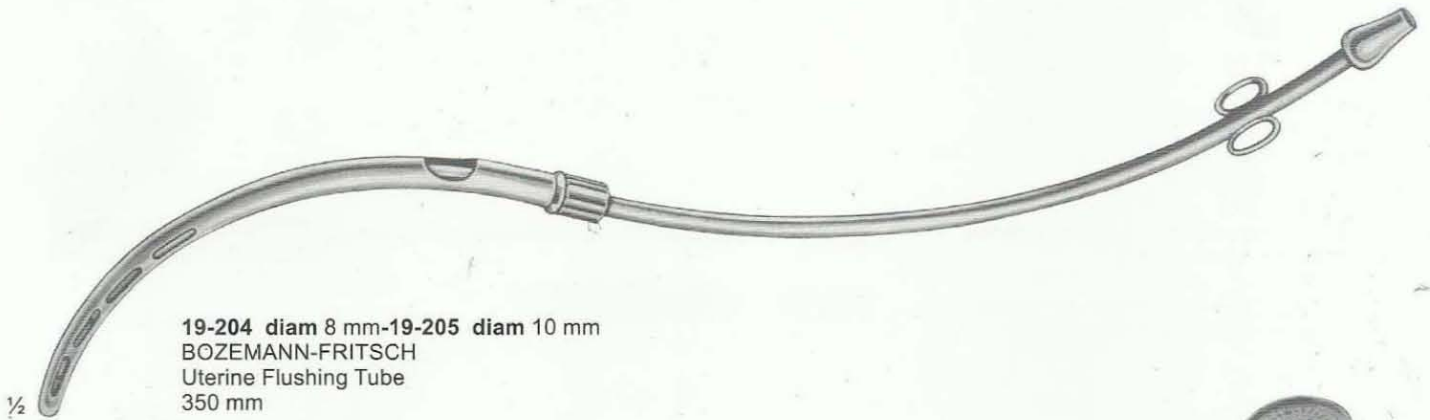

19-204 diam 8 mm-19-205 diam 10 mm
BOZEMANN-FRITSCH
Uterine Flushing Tube
350 mm

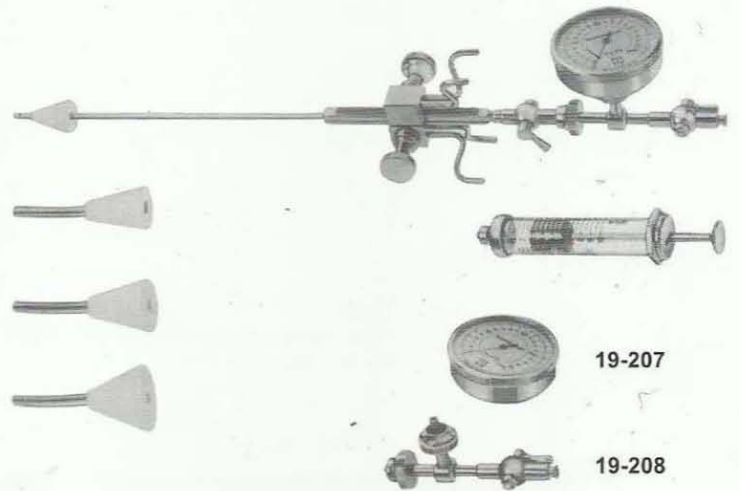

19-206
SCHULZE
Salpingograph, for utero-salpingography
in wooden case, consisting of:
19-207 Manometer only
19-208 Connection only, without manometer
19-209 Uterine cannula with tape without cone
19-210 Cone only, small
19-211 Cone only, medium
19-212 Cone only, large
19-213 Record syringe, 10CC, luer-lock mount.

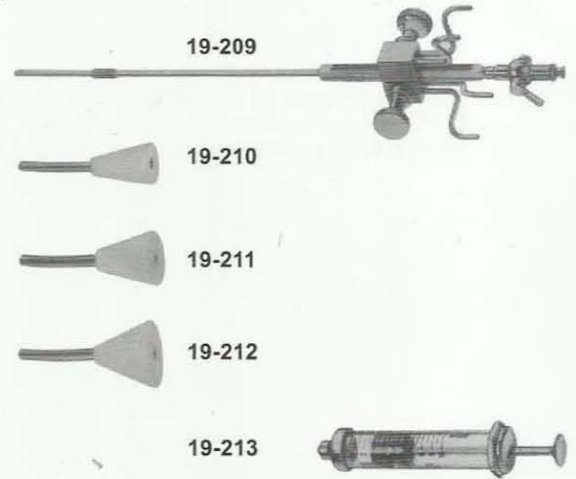

19-214
SCHULZE
Salpingograph, equipment like(19-206)
but without manometer.

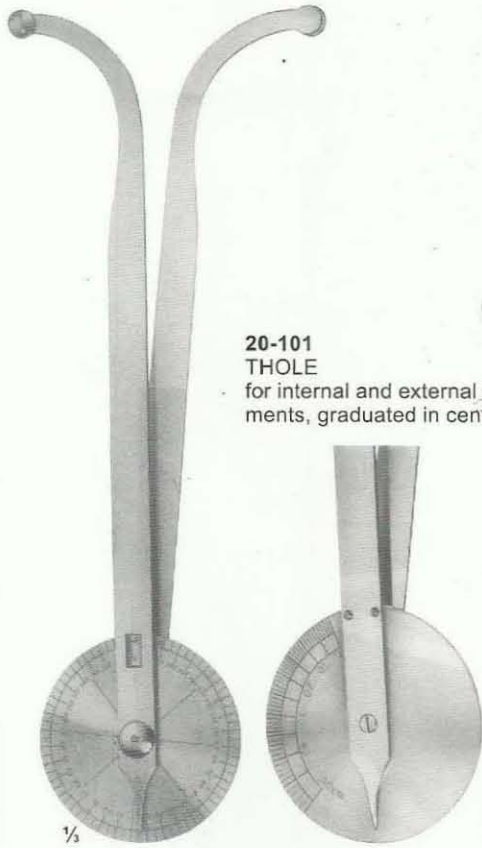

20-101
THOLE
for internal and external measurements, graduated in centimeters

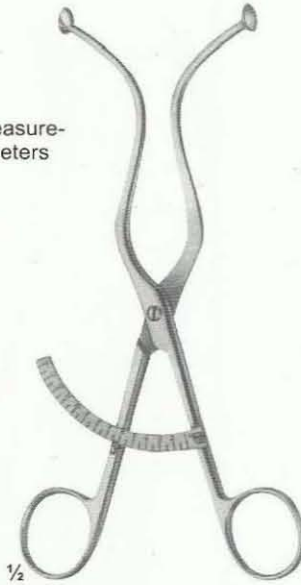

20-102
DE LEE
graduated in centimeters and inches



20-103
COLLIN
graduated in centimeters



20-104
MARTIN
graduated in centimeters

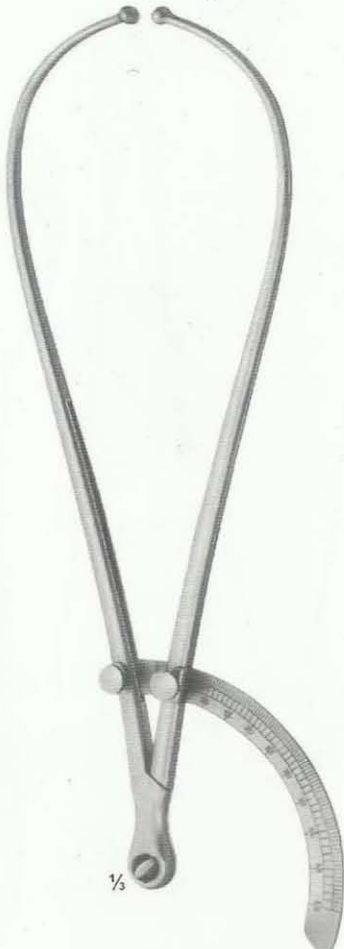

20-105
SCHNEIDER
graduated in centimeters

The additional straight arm can be replaced. The pelvimeter with straight arm is used for localisation of the portio vaginalis uteri and of vaginal metastasis.



20-106
BREISKY
graduated in centimeters



Gyneco

- 20-107 4 mm Ø
- 20-107A 6 mm Ø
- 20-107B 8 mm Ø
- 20-107C 10 mm Ø
- 20-107D 12 mm Ø
- 20-107E 14 mm Ø
- 20-107F 16 mm Ø



Smellie
20-107G
33 cm / 13"



Wallich
20-107H
42 cm / 16½"

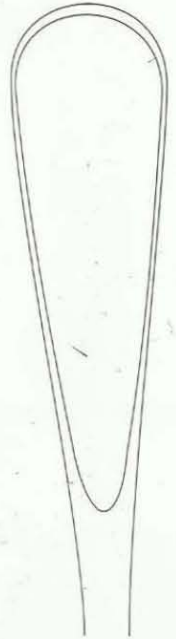

- 20-107J 12 mm
 - 20-107K 14 mm
 - 20-107L 16 mm
 - 20-107M 20 mm
- Blunt



CUZZI
30 cm / 12"

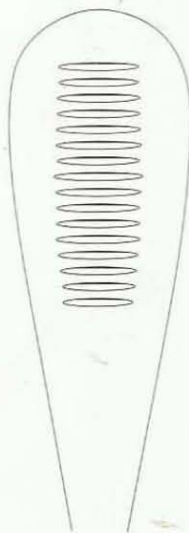

Toothed back



20-108
14.5 mm
Blunt



20-108A
18 mm
Blunt



20-108B
21 mm
Blunt



DANIS
20-108C
24 cm / 9½"

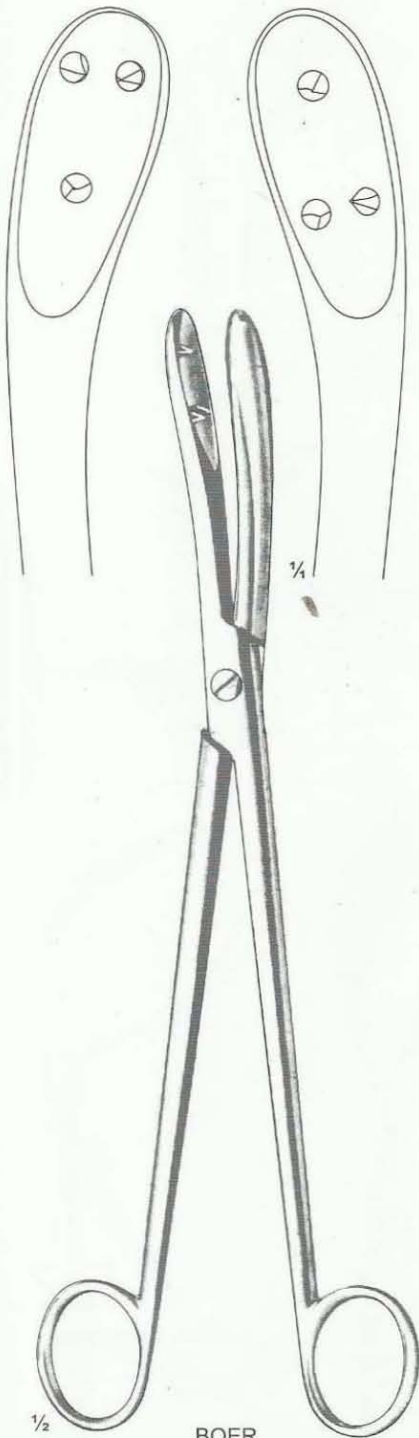

BOER
20-109
29 cm
Craniotomy forceps

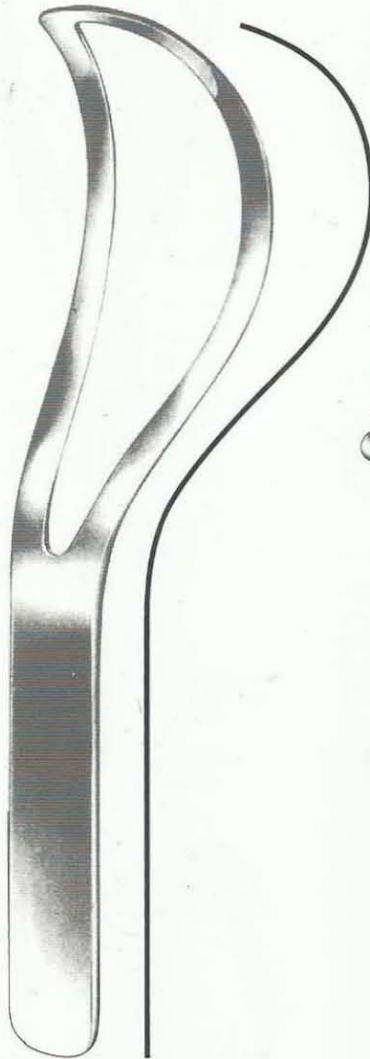

SELLHEIM
20-110
30 cm
Obstetric lever

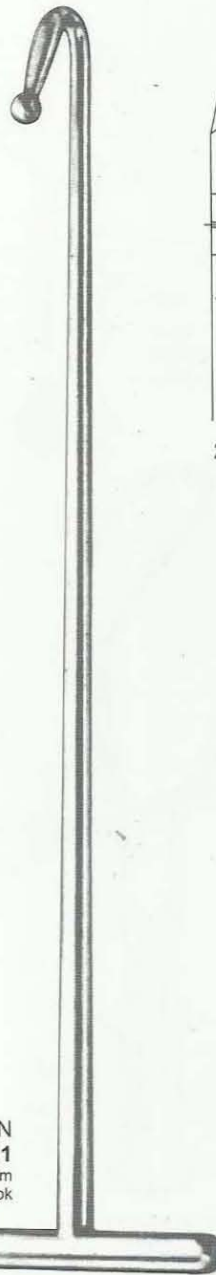

BRAUN
20-111
32.5 cm
Decapitating hook

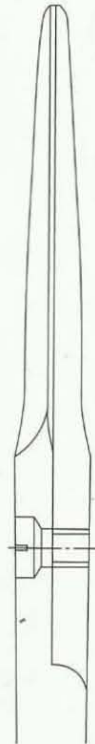

20-112

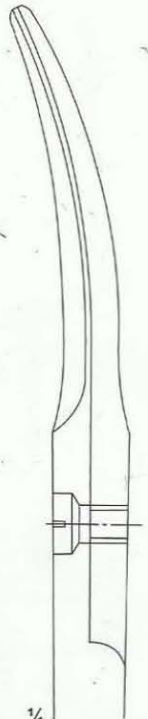

20-113

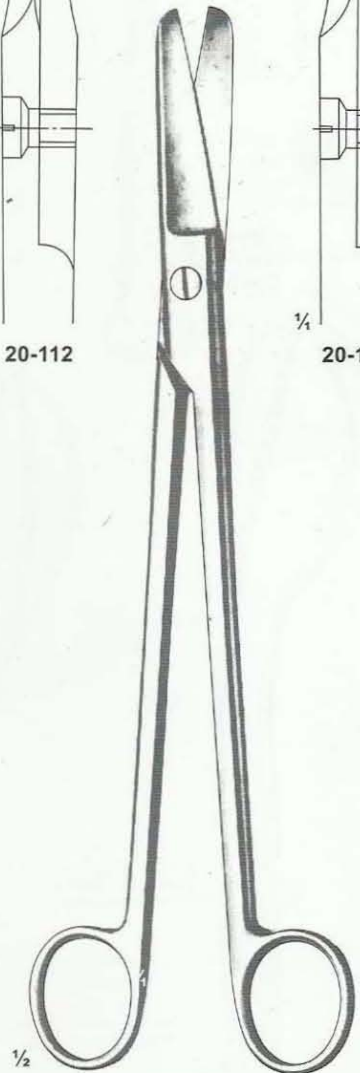

DUBIOS
27.5 cm
Decapitating scissors
(embryotomy)

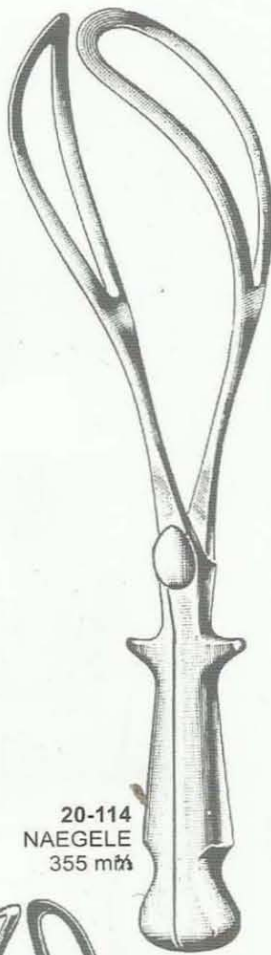

20-114
NAEGELE
355 mm

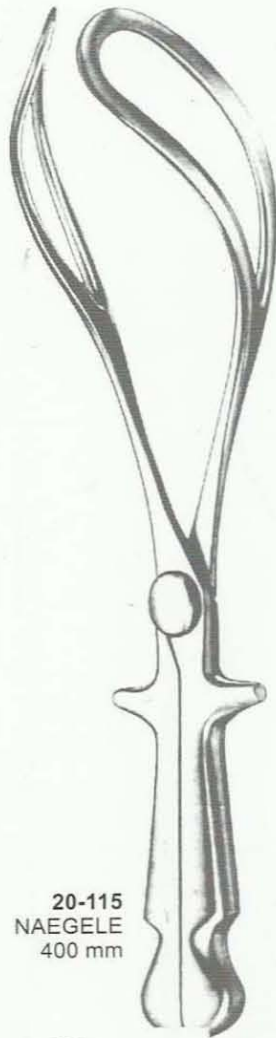

20-115
NAEGELE
400 mm

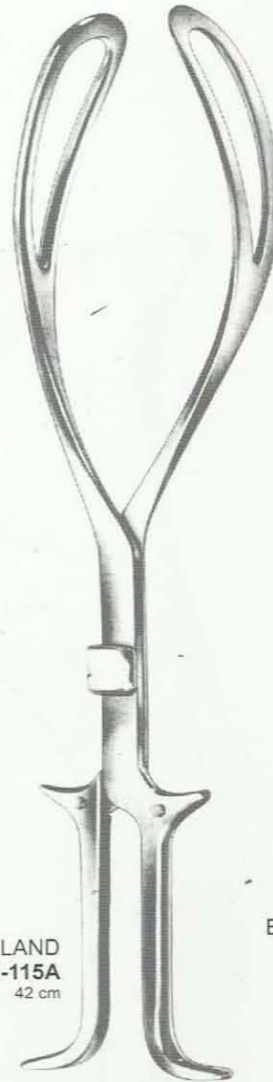

KIELLAND
20-115A
42 cm

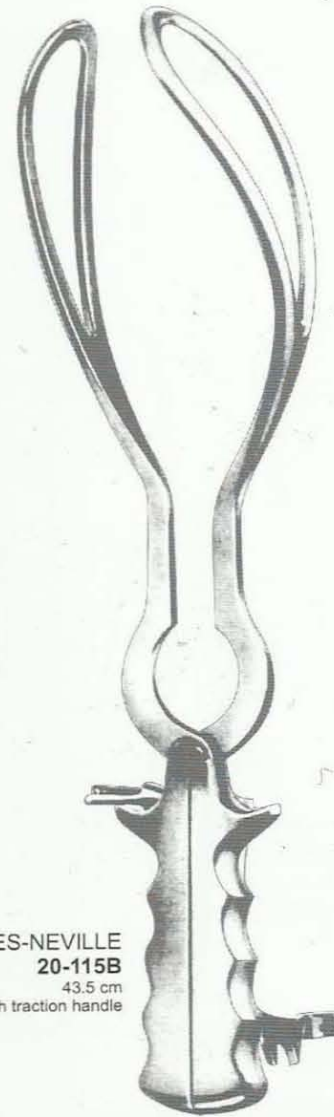

BARNES-NEVILLE
20-115B
43.5 cm
With traction handle

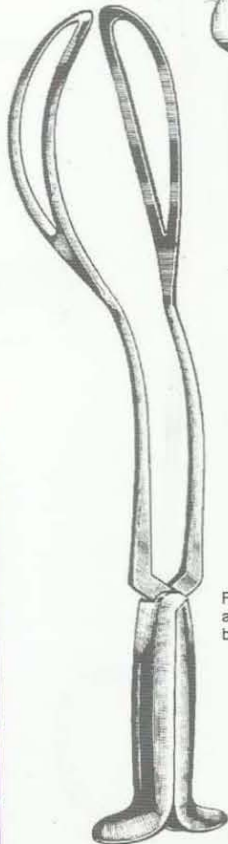

For delivery of the
after coming head in
breech presentation

PIPER
20-115C

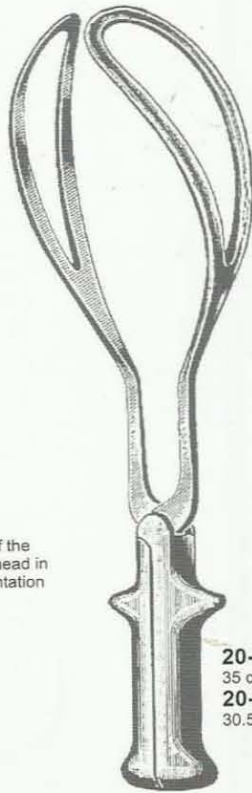

20-116
35 cm
20-116A
30.5 cm

SIMPSON-BRAUN
305mm

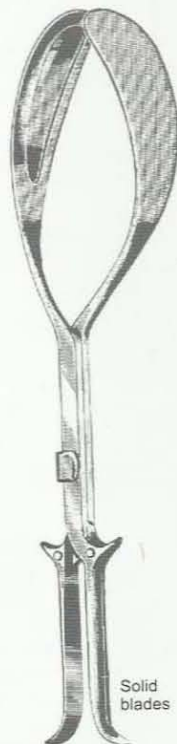

Solid
blades

KIELLAND-LUIKART
20-116B

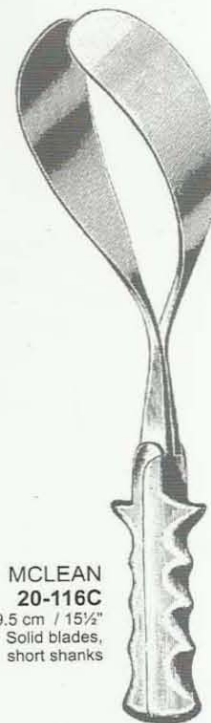

MCLEAN
20-116C
39.5 cm / 15½"
Solid blades,
short shanks

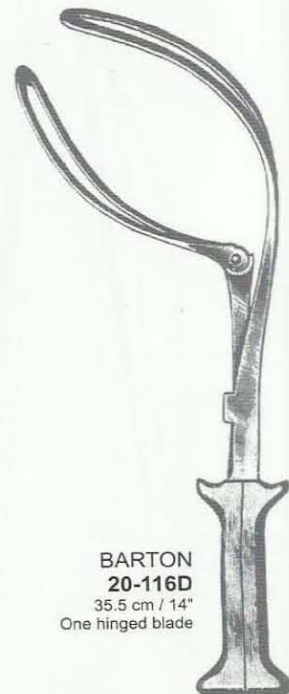

BARTON
20-116D
35.5 cm / 14"
One hinged blade

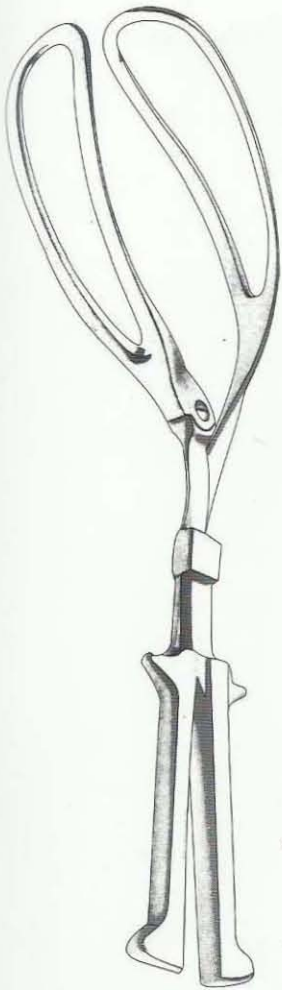

DEMELIN SUZOR
20-117
32 cm

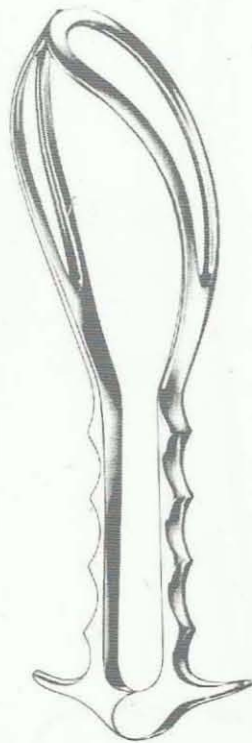

BOERMA
20-117A
28 cm
For caesarean section

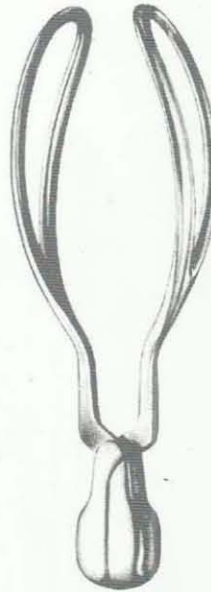

SIMPSON
20-118
23.5 cm
For caesatean section

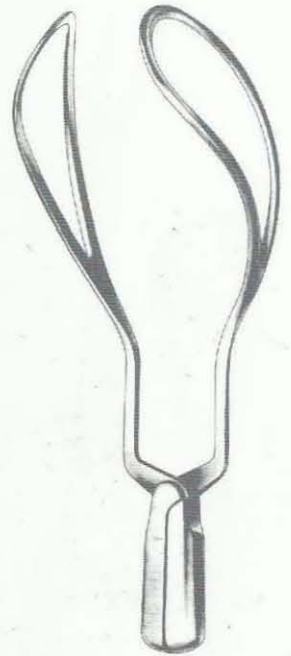

WRIGLEY
20-118A
25 cm
For caesatean section

For caesarean section

For caesarean section



MURLESS
20-119
25.5 cm
Head extractor
with hinged shaft and sliding collar lock



DEWEY
20-119A
35.5 cm
Obstetrical forceps
with axis traction



20-120A
HERFF
membrane
puncturing
forceps
255 mm



20-121A
LOWA
membrane
puncturing
forceps
260 mm



$\frac{1}{2}$ **20-120**
GREEN-ARMYTAGE
Caesarean section haemostatic
forceps, for edges of the transverse
incision in the lower segment
220 mm

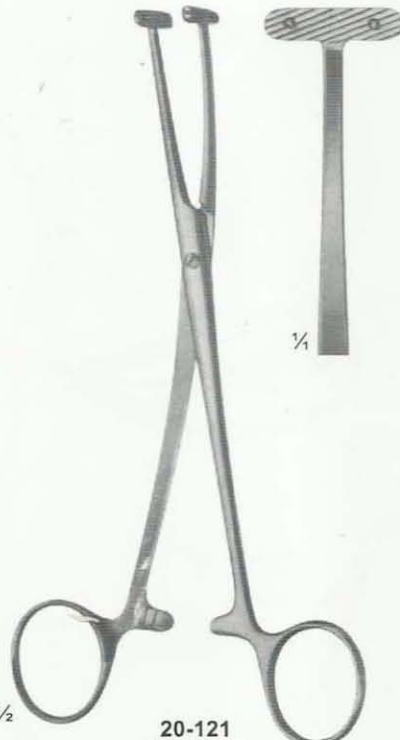

$\frac{1}{2}$ **20-121**
WILLET
Scalp Flap forceps
185 mm

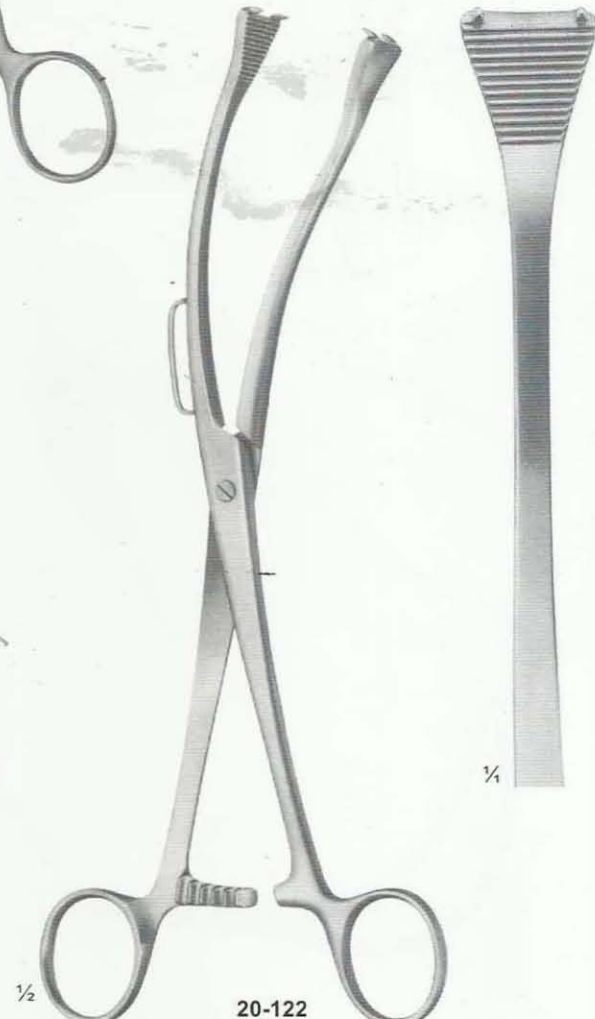

$\frac{1}{2}$ **20-122**
GAUSS
Scalp Flap forceps
260 mm



Fig: 1
20-123

Fig: 2
20-124

Fig: 3
20-125

Fig: 1
20-126

Fig: 2
20-127

Fig: 3
20-128

20-123 - 125
WINTER
290 mm

20-126 - 128
WINTER
290 mm

20-129
SAENGER
275 mm

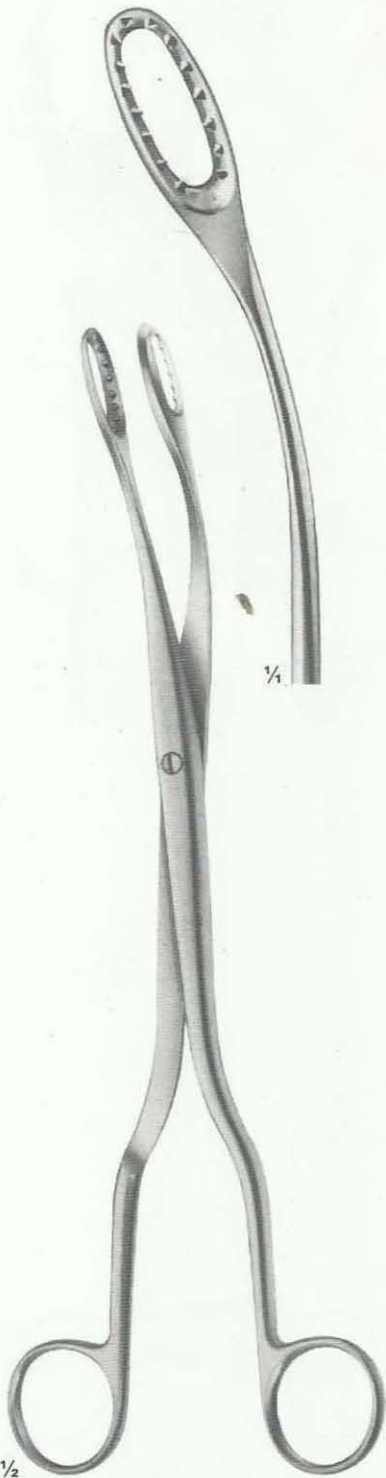

20-130
SAENGER
285 mm

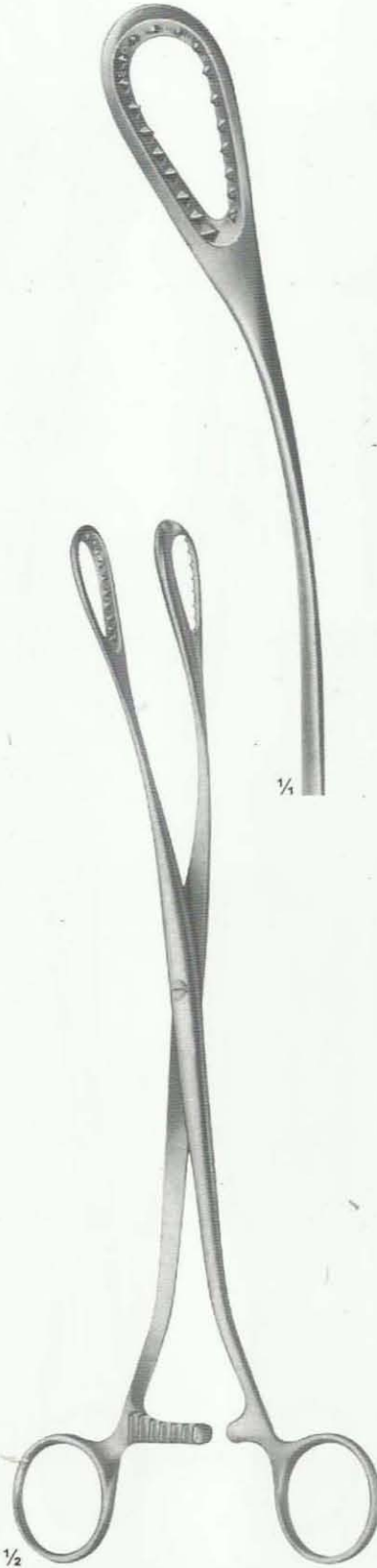

20-131
SAENGER
265 mm

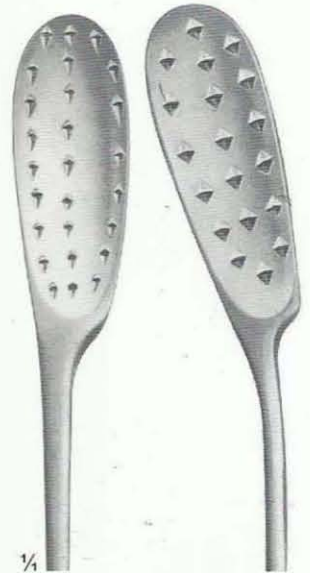

1/4
20-132

20-133

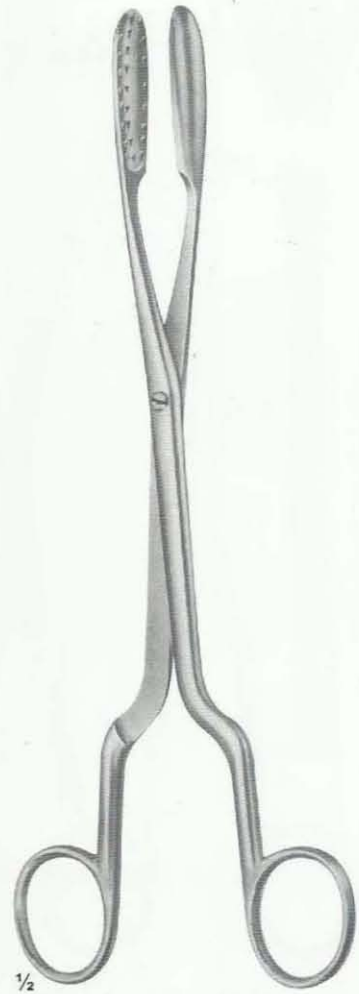

20-132 - 133
LEWKOWITZ
245 mm

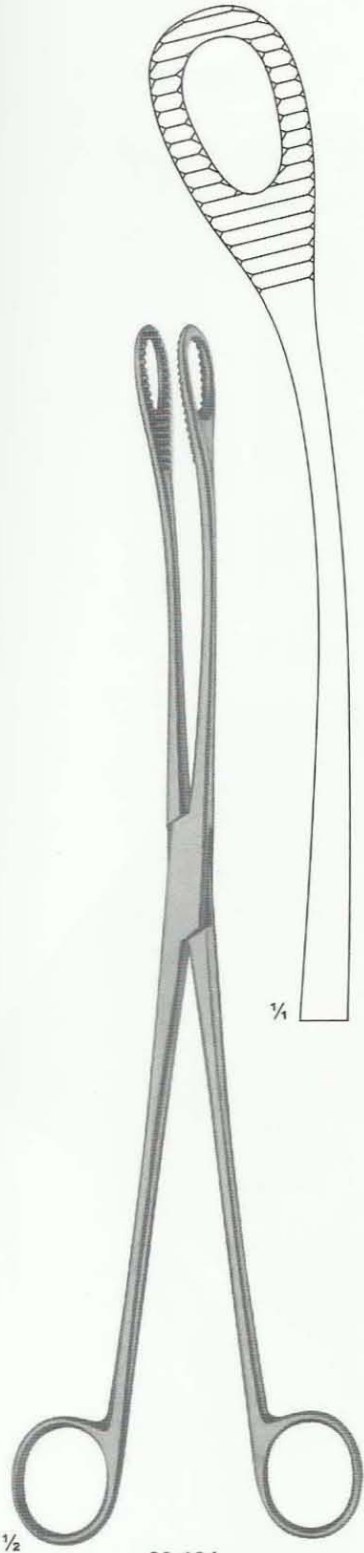

20-134
 KELLY
 320mm

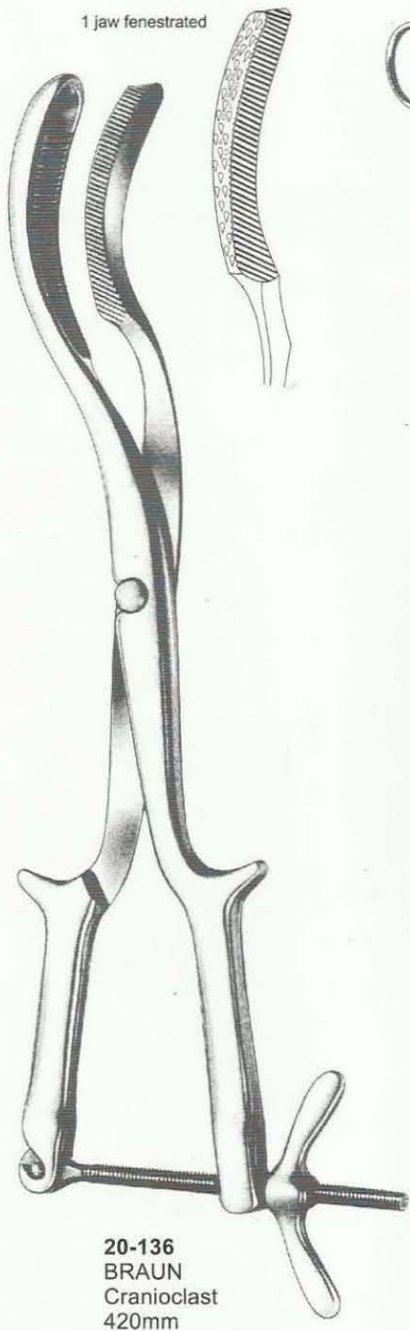

20-136
 BRAUN
 Cranioclast
 420mm

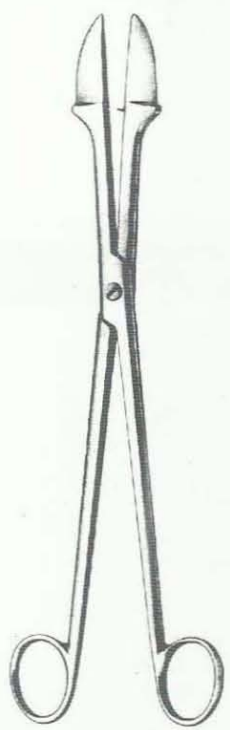

20-135
 SMELLIE
 Perforator
 270mm

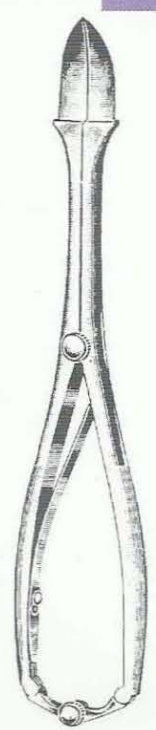

NAEGELE
 20-135A
 25 cm

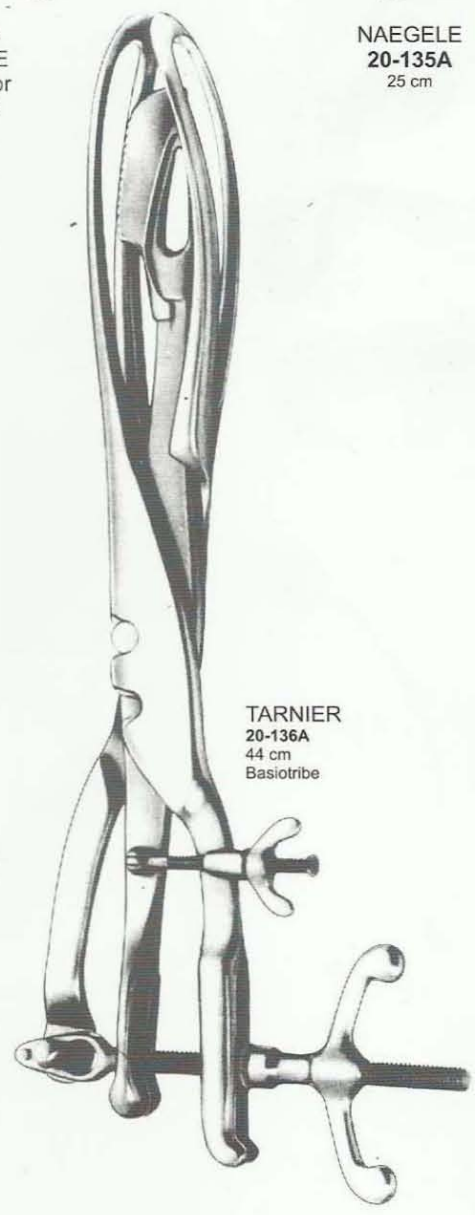

TARNIER
 20-136A
 44 cm
 Basiotribe

SECTION

PAGE

**Cardiovascular,
Tracheotomy
& Thoracic
Surgery**

21

255-309

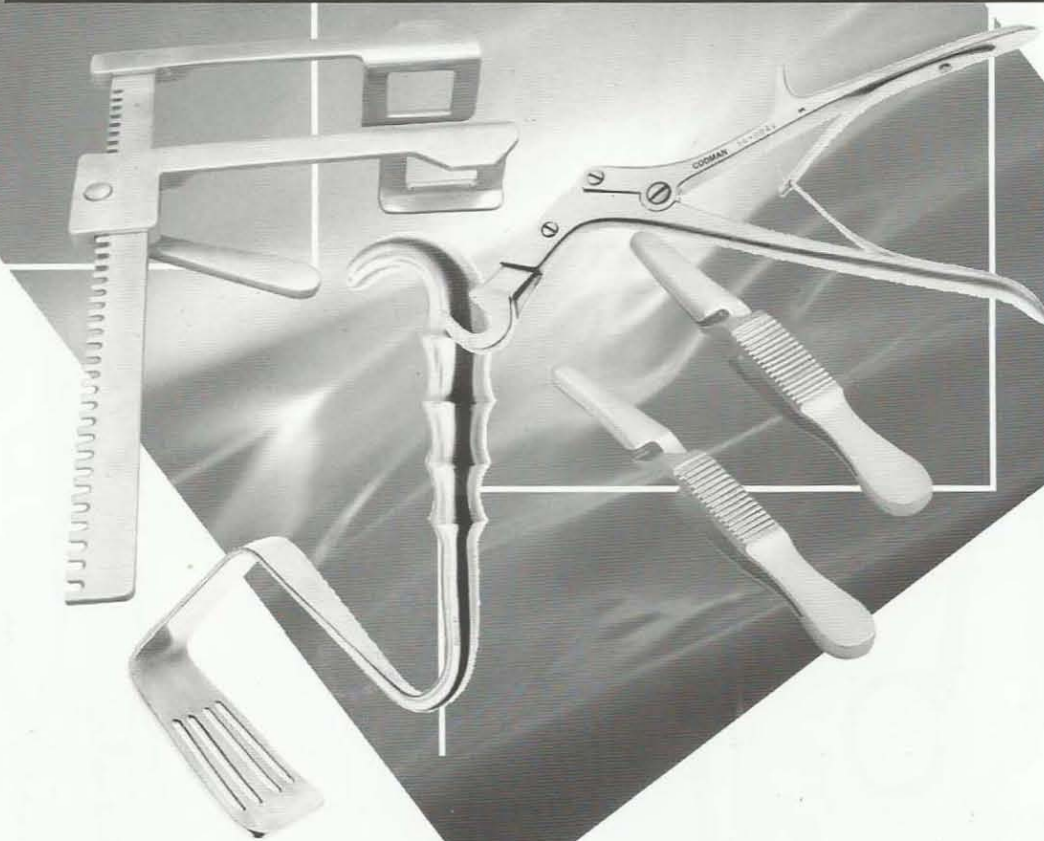

Tracheal Tubes with inner tubes

Fig.	0	1	2	3	4	5	6	7	8	9	10
∅ mm	4	5	6	7	8	9	10	11	12	13	14
Charr./Fr.	12	15	18	21	24	27	30	33	36	39	42



20-137
UECKERMANN-DENKER
 Cryothyrotomy trocar
 with silver cannula
 130mm

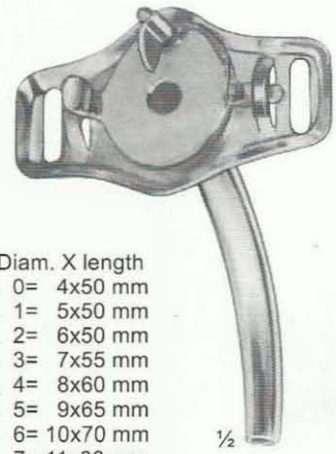

Diam. X length
20-138 Fig. 0= 4x50 mm
20-139 Fig. 1= 5x50 mm
20-140 Fig. 2= 6x50 mm
20-141 Fig. 3= 7x55 mm
20-142 Fig. 4= 8x60 mm
20-143 Fig. 5= 9x65 mm
20-144 Fig. 6= 10x70 mm
20-145 Fig. 7= 11x80 mm
20-146 Fig. 8= 12x85 mm
20-147 Fig. 9= 13x90 mm
20-148 Fig. 10= 14x90 mm

20-138 - 148
LUER
 German silver



20-149 - 158
JACKSON
 German Silver

Diam. X length
20-149 Fig. 0= 4x50 mm
20-150 Fig. 1= 5x48 mm
20-151 Fig. 2= 6x58 mm
20-152 Fig. 3= 7x70 mm
20-153 Fig. 4= 8x78 mm
20-154 Fig. 5= 9x84 mm
20-155 Fig. 6= 10x84 mm
20-156 Fig. 7= 11x86 mm
20-157 Fig. 8= 12x88 mm
20-158 Fig. 9= 13x90 mm



Diam. X length
20-159 Fig. 1= 5x48 mm
20-160 Fig. 2= 6x58 mm
20-161 Fig. 3= 7x70 mm
20-162 Fig. 4= 8x78 mm
20-163 Fig. 5= 9x84 mm
20-164 Fig. 6= 10x84 mm
20-165 Fig. 7= 11x86 mm
20-166 Fig. 8= 12x88 mm
20-167 Fig. 9= 13x90 mm
20-168 Fig. 10= 14x90 mm

20-159 - 168
JACKSON
 Stainless Steel



20-169
BOSE
165 mm



20-170
BOSE
165 mm



20-171 - 173
180 mm



20-172
blunt

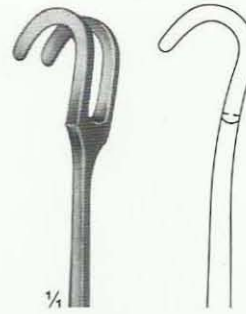

20-173
blunt

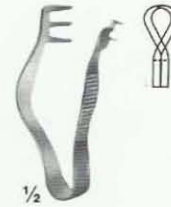

20-174
FINSEN
50 mm

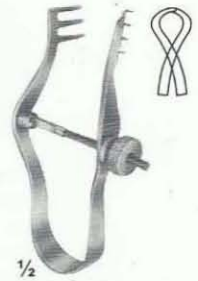

20-175
FINSEN
70 mm



20-176
TROUSSEAU
120 mm



20-177
LABORDE
125 mm



20-178
LABORDE
strong pattern
135 mm



20-179
Cleaning Brush
for tracheal tubes
285 mm

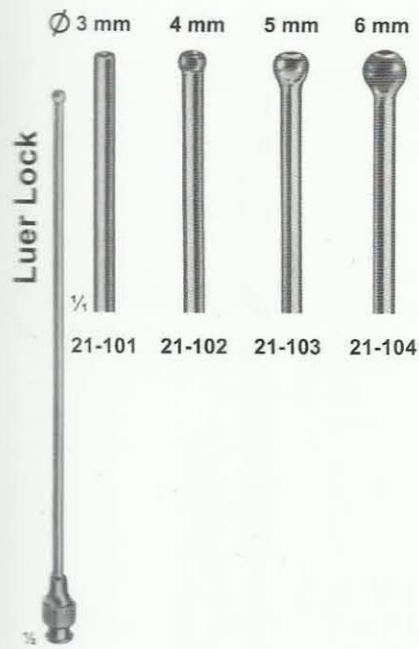

21-101 - 104
SCHMID
 Vessel irrigating cannulae,
 malleable, silver plated
 150 mm

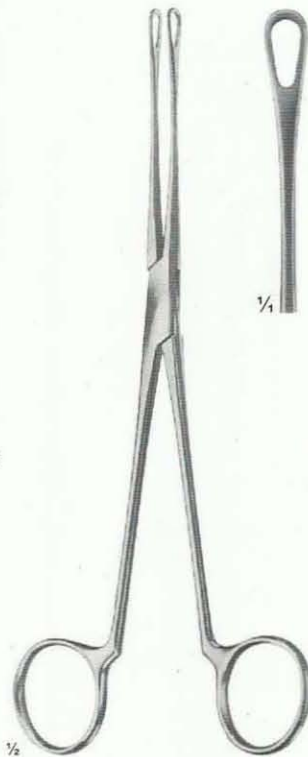

21-105
BLAKE
 Embolus grasping
 forceps
 205 mm

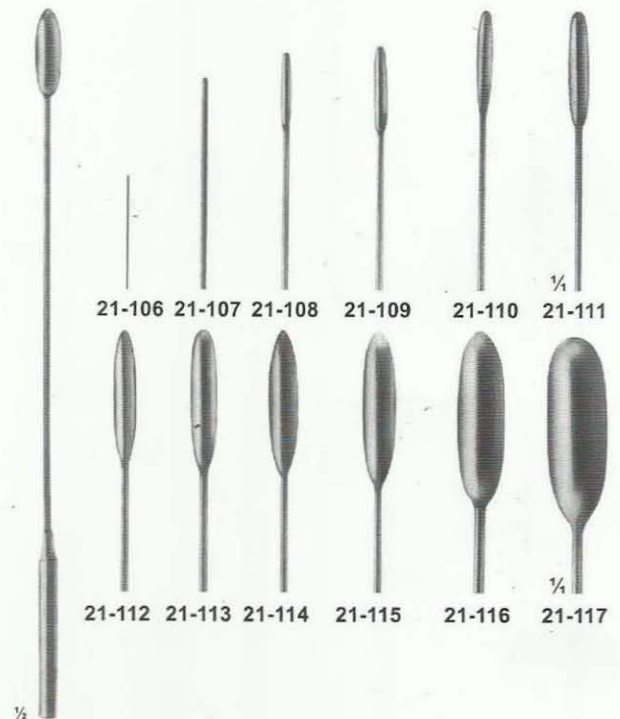

21-106 - 117
DE BAKEY
 Vascular dilators,
 malleable
 190 mm

21-106 0,5 mm Ø	21-112 3,5 mm Ø
21-107 1,0 mm Ø	21-113 4,0 mm Ø
21-108 1,5 mm Ø	21-114 4,5 mm Ø
21-109 2,0 mm Ø	21-115 5,0 mm Ø
21-110 2,5 mm Ø	21-116 7,0 mm Ø
21-111 3,0 mm Ø	21-117 9,0 mm Ø

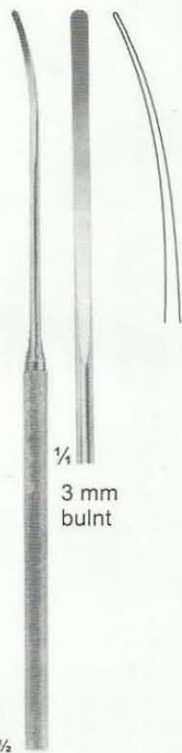

21-118
185 mm
21-119
215 mm



21-120
230 mm

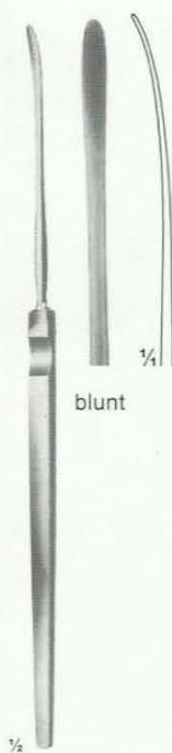

21-121
HALLE
180 mm



21-122
FREER
sharp/blunt
185 mm



21-123 - 124
SCHMID
140 mm
235 mm



21-125
DAVIS
245 mm

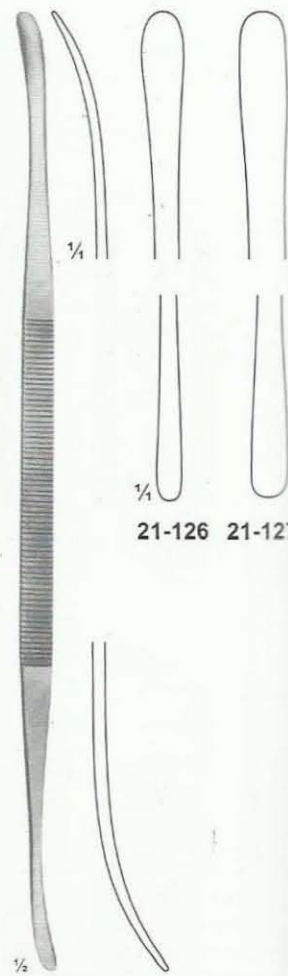

21-126 - 127
TOENNIS
240 mm

1/4 sharp blunt

blunt

21-123 blunt

21-124 blunt

21-126 21-127

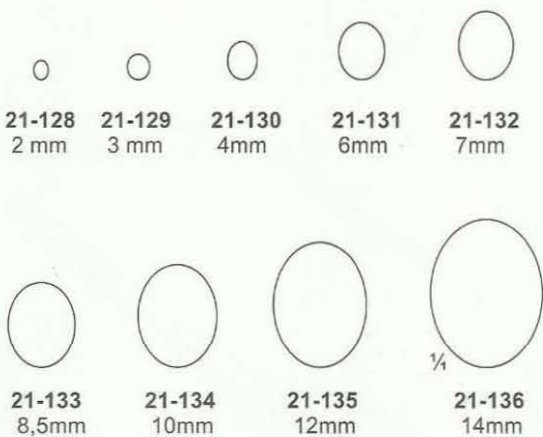

21-128 - 136
Endarterectomy strippers
550 mm



21-137
Handle for (21-128-136)
110 mm

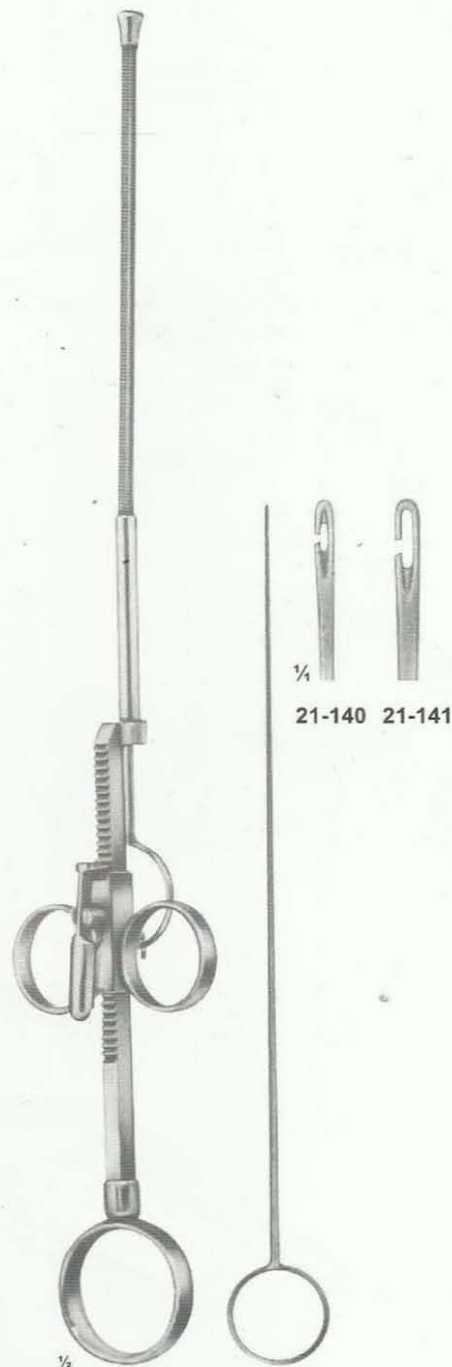

21-138 - 139
RUMEL-BELMONT
325 mm
21-138 - 4,0 mm Ø
21-139 - 6,4 mm Ø

21-140 - 141
Guide only

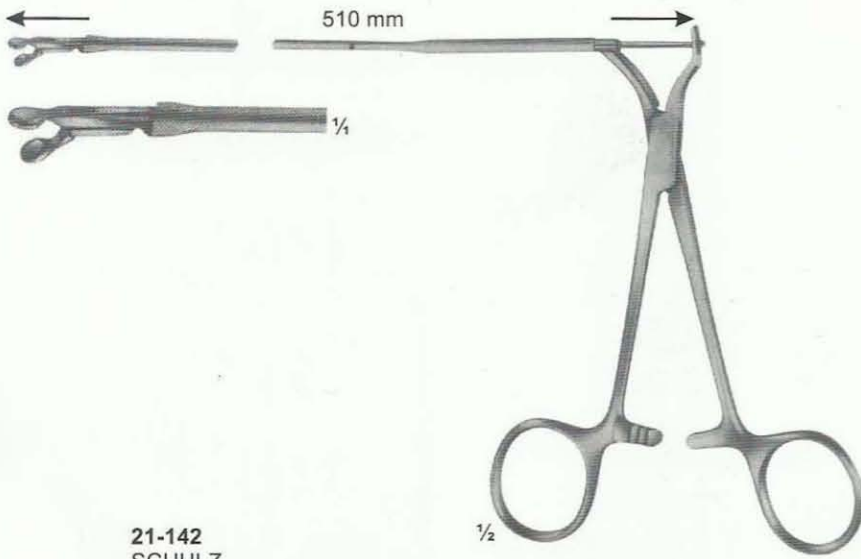

21-142
SCHULZ
 Bioptome, with flexible Shaft, 510 mm long,
 with round jaws 3 mm diam.
 Biopsy forceps, for biopsy from the right atrium
 through cava jugularis, prior to heart implantations.

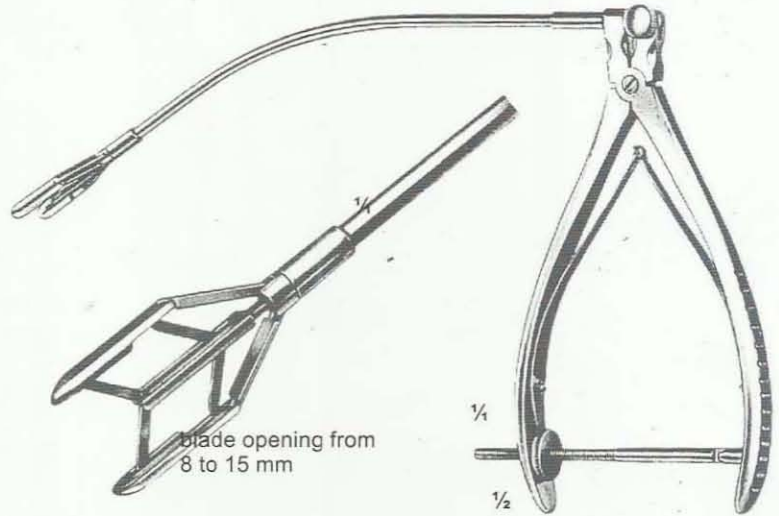

21-144
COOLEY
 Dilator for
 mitral valve
 for children

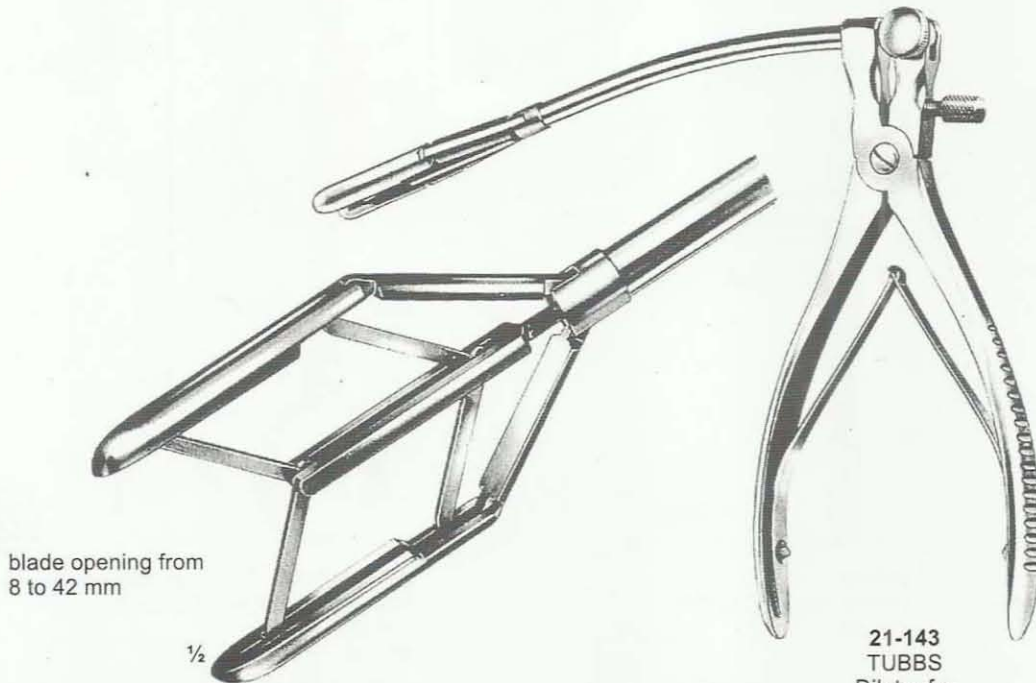

21-143
TUBBS
 Dilator for
 mitral valve

JENKER Instrument Set For Tunnelling And Pulling Through Vascular Grafts Toothings

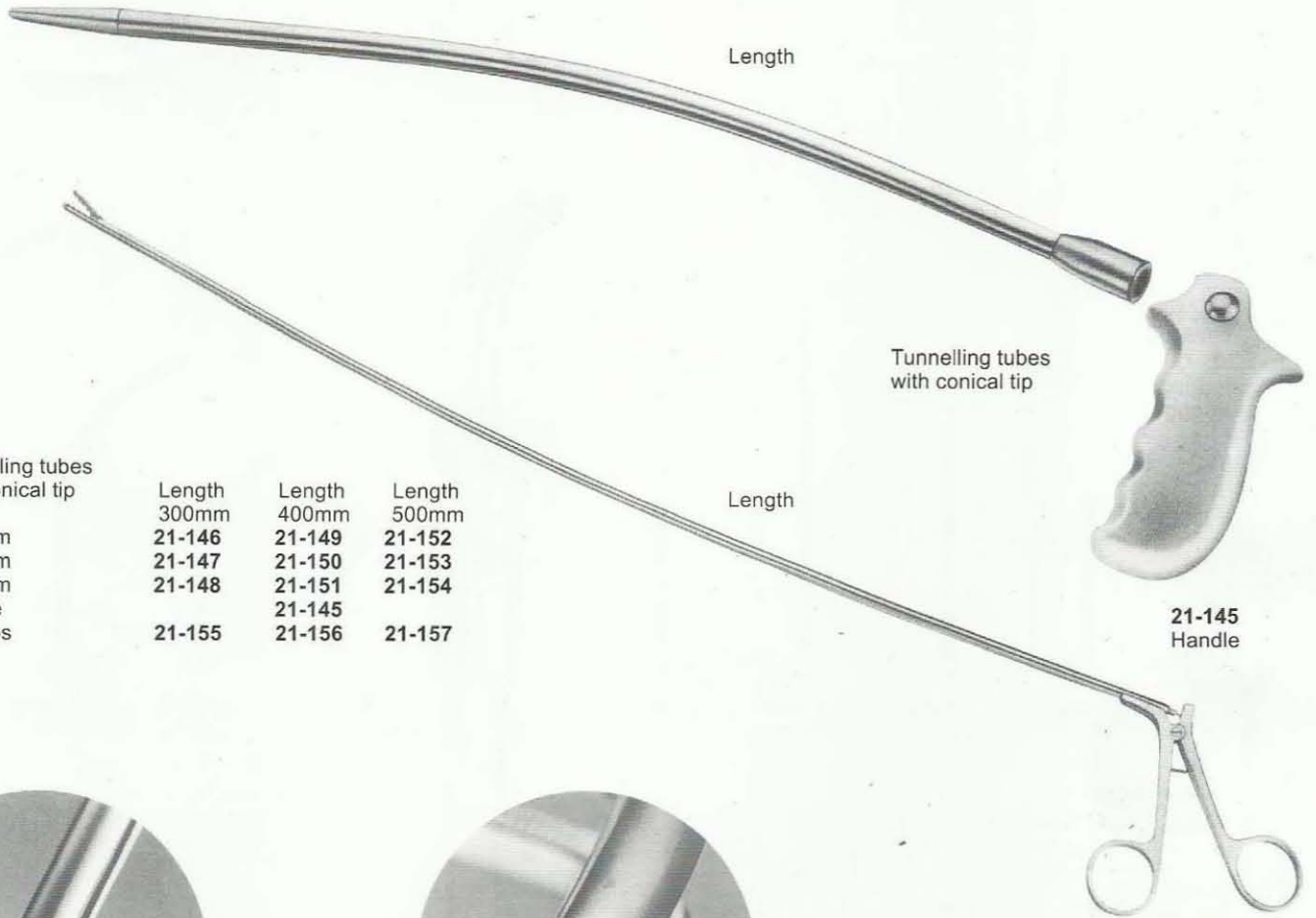

Tunnelling tubes with conical tip

Tunnelling tubes with conical tip

	Length 300mm	Length 400mm	Length 500mm
∅ 12mm	21-146	21-149	21-152
∅ 14mm	21-147	21-150	21-153
∅ 17mm	21-148	21-151	21-154
Handle	21-155	21-145	21-157
Forceps		21-156	

21-145 Handle

21-155 Forceps

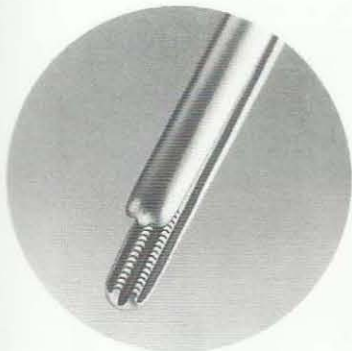

DE BAKEY

21-158

1 : 2 rows of teeth

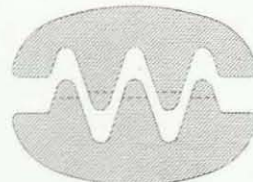
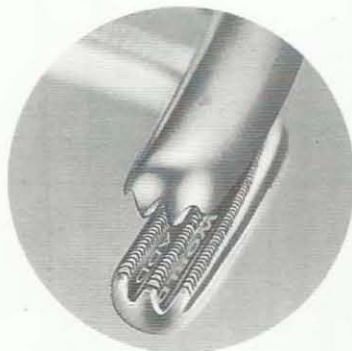

DE BAKEY

21-159

2 : 3 rows of teeth

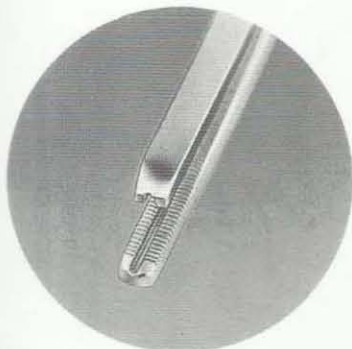

COOLEY

21-160

2 : 2 rows of teeth

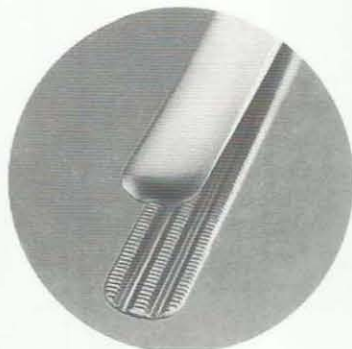

DARDIK

21-161

2 : 3 rows of teeth



21-162
7.5 cm



21-162A
8.5 cm



21-162B
10.5 cm



21-162C
12 cm



21-163
7 cm

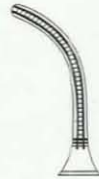

21-163A
8 cm



21-163B
10 cm

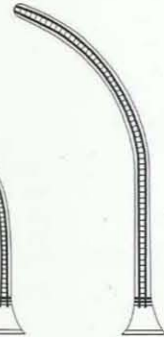

21-163C
11.5 cm

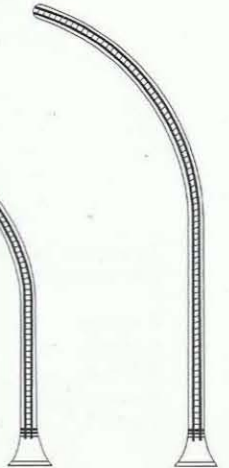

DE BAKEY

DE BAKEY

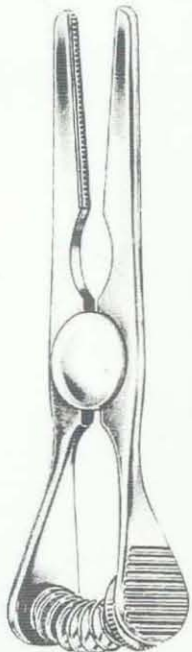

21-164
6 cm



21-164A
7 cm



21-164B
9 cm



21-164C
11 cm

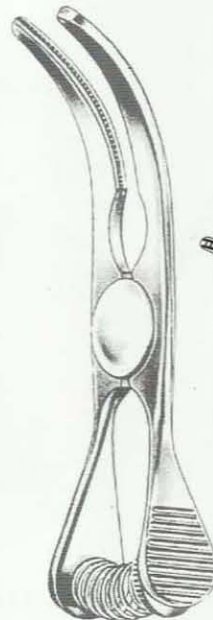

21-165
5.5 cm



21-165A
6.5 cm



21-165B
8.5 cm



21-165B
10.5 cm

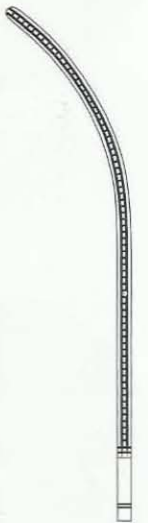

GLOVER

GLOVER

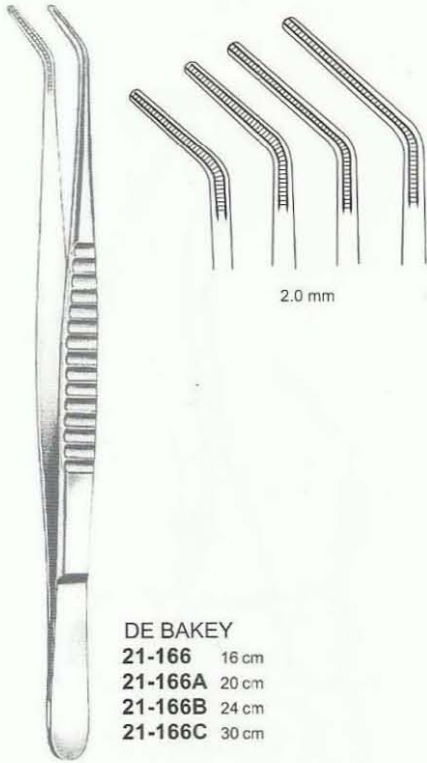

DE BAKY
21-166 16 cm
21-166A 20 cm
21-166B 24 cm
21-166C 30 cm

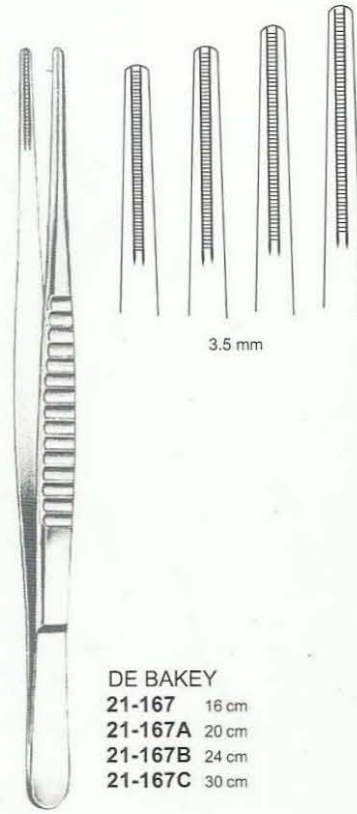

DE BAKY
21-167 16 cm
21-167A 20 cm
21-167B 24 cm
21-167C 30 cm

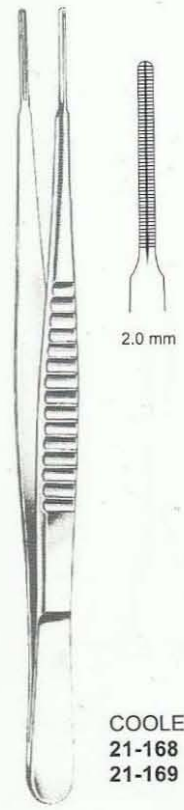

COOLEY
21-168 16 cm
21-169 20 cm

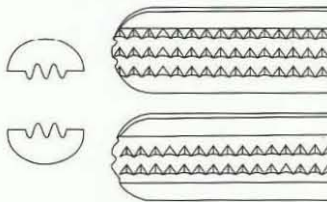

Toothing according to De Bakey:
 The traditional ATRAUMA clamps.
 Apart from Cardio-Vascular Surgery,
 They are also approved for other
 atraumatic application and surgery
 techniques. Firm and precise seizing
 of tissues. Safe and delicately controlled
 clamping effect.

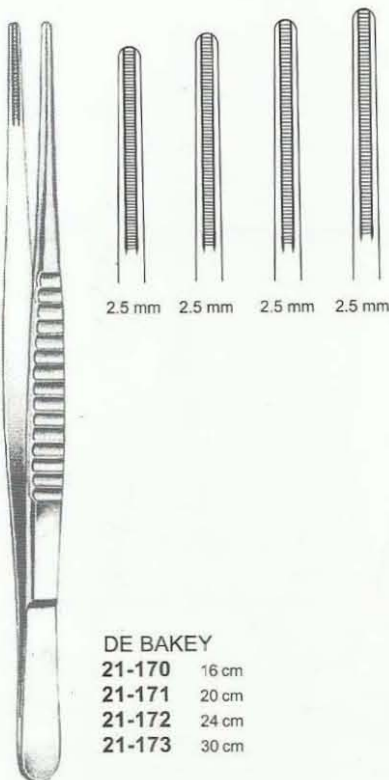
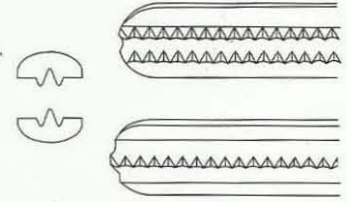

DE BAKY
21-170 16 cm
21-171 20 cm
21-172 24 cm
21-173 30 cm

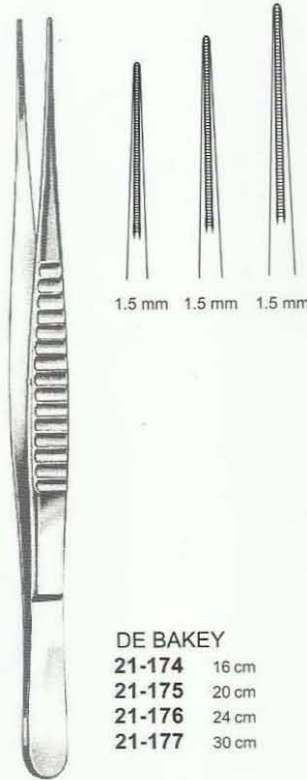

DE BAKY
21-174 16 cm
21-175 20 cm
21-176 24 cm
21-177 30 cm

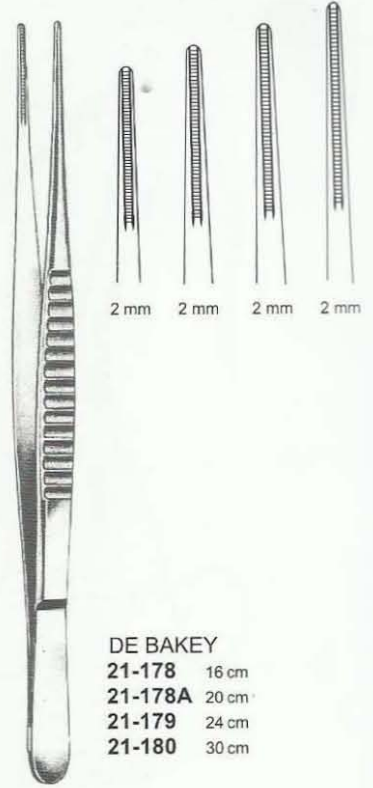

DE BAKY
21-178 16 cm
21-178A 20 cm
21-179 24 cm
21-180 30 cm

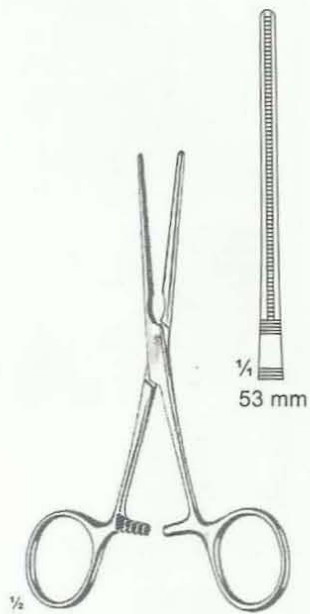

21-181
DE-BAKEY
straight
130 mm

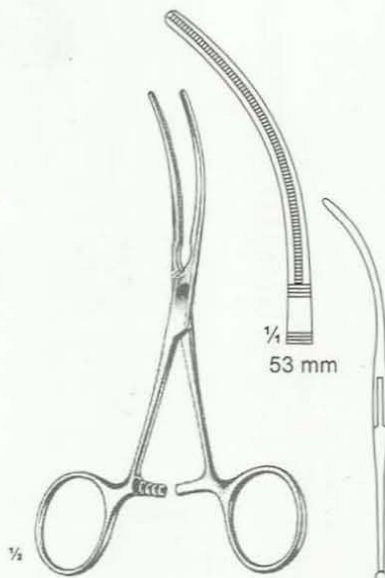

21-182
DE-BAKEY
curved jaws
125 mm

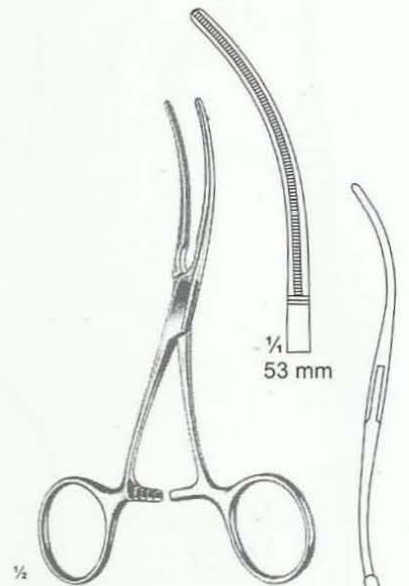

21-183
DE-BAKEY
S-shaped curved
125 mm

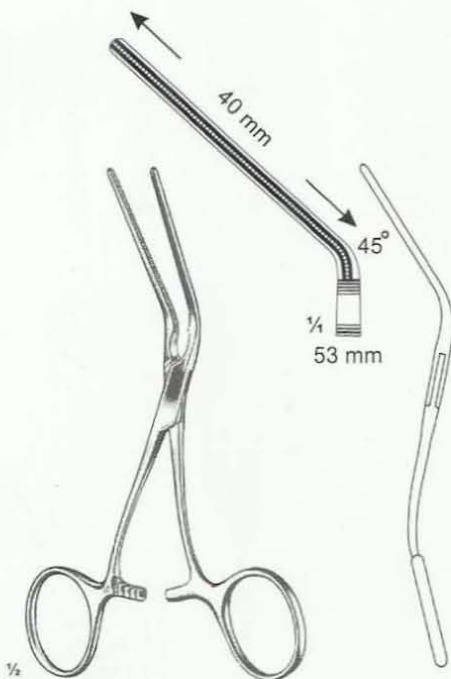

21-184
DE-BAKEY
angled 45°
125 mm

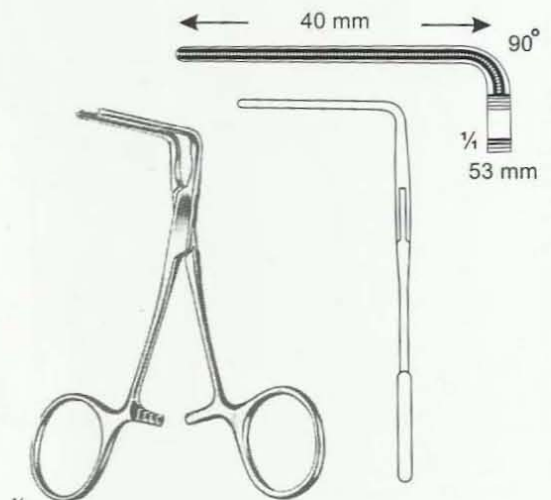

21-185
DE-BAKEY
angled 90°
105 mm



21-186 - 189
CASTANEDA

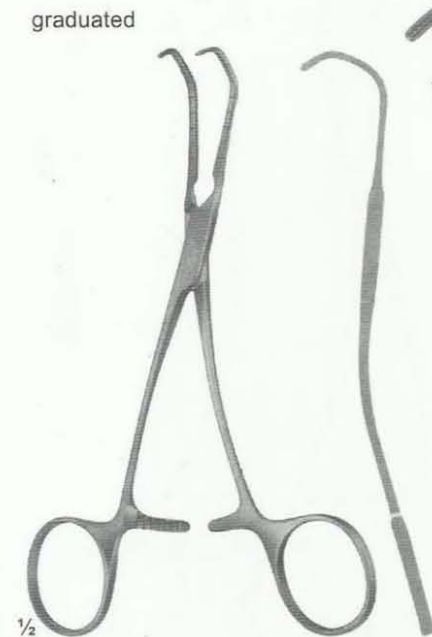
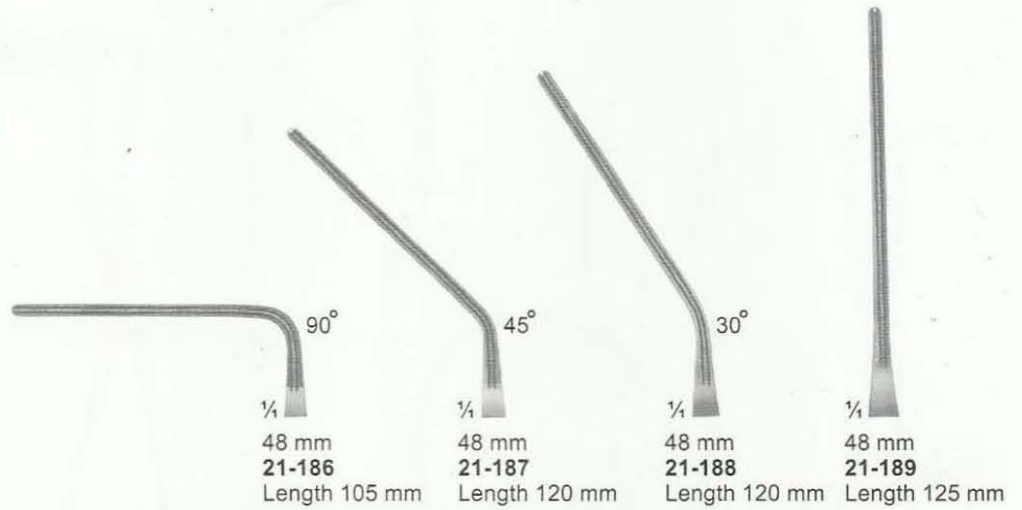

21-190 - 193
CASTANEDA

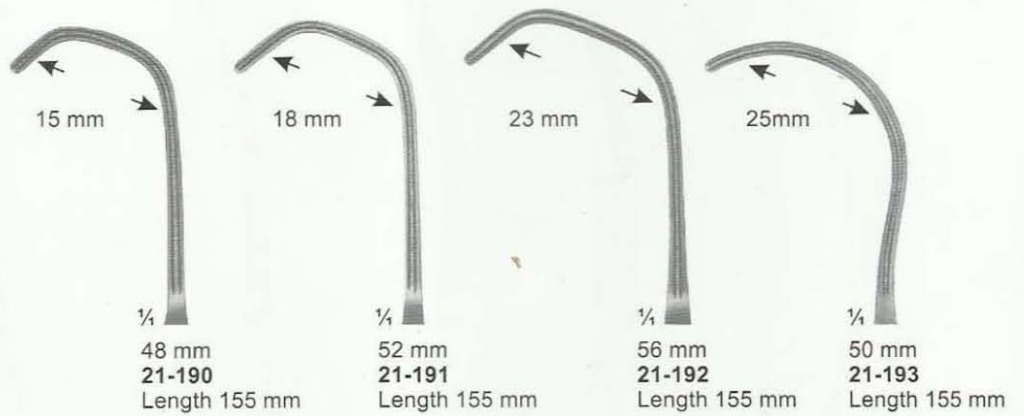

Atraumata Anastomosis-and Multi-Purpose-Clamps-Pediatric types

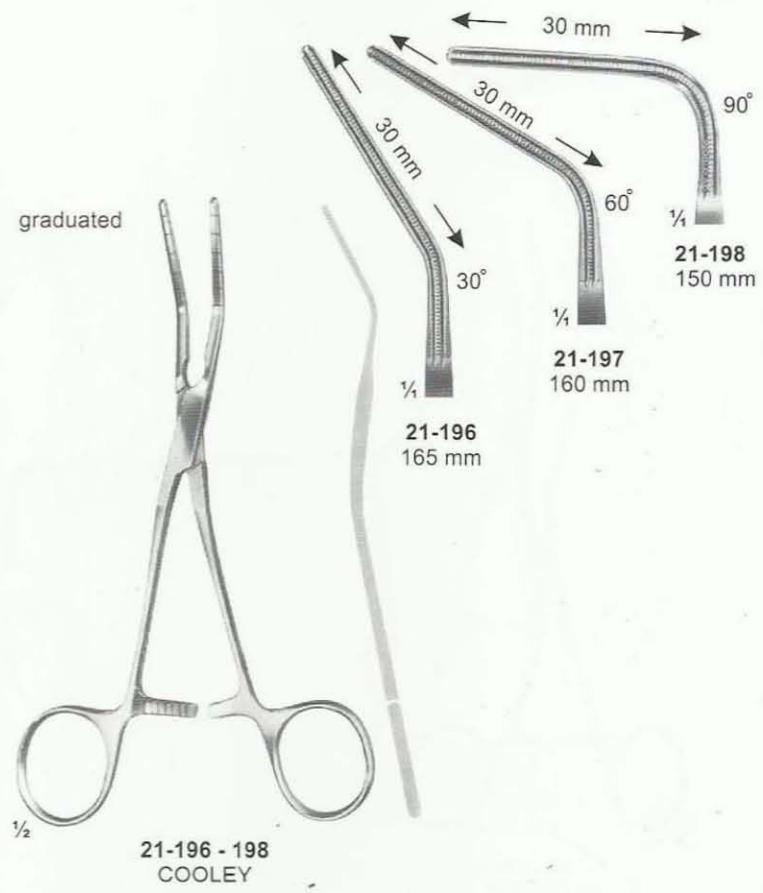
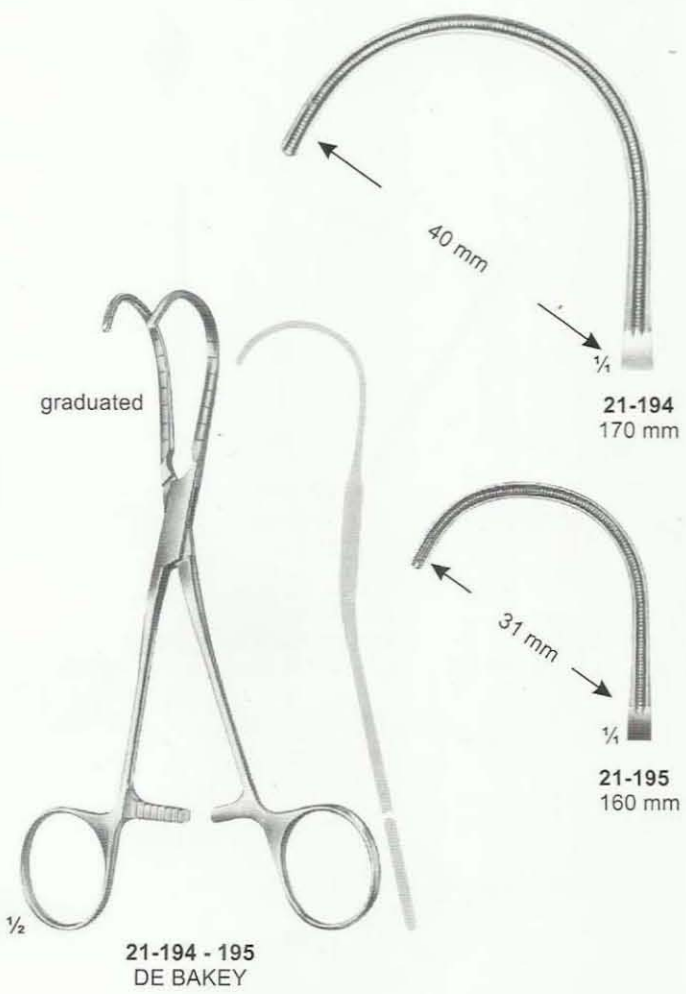

Mosquito Forceps

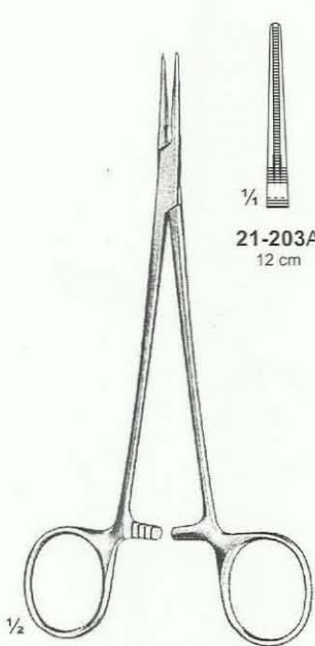

De Bakey-Mosquito
21-203 - 204
125 mm



21-203A
12 cm



21-203
12 cm



21-204
15 cm

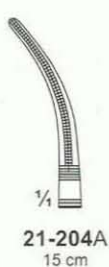

21-204A
15 cm

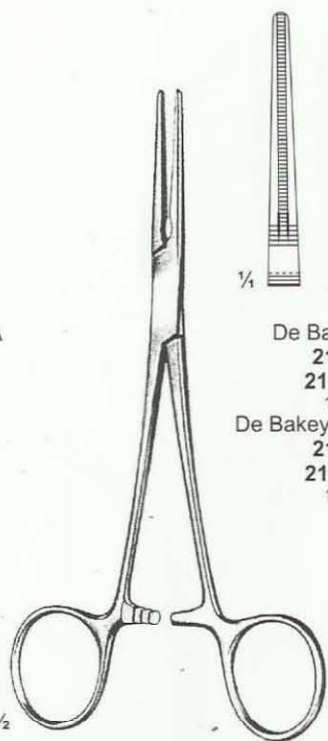

21-205 - 206
165 mm

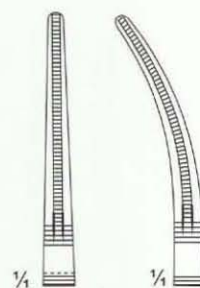

De Bakey-Crile
21-205 Straight
21-205A Curved
14 cm
De Bakey-Crile-Rankin
21-205 Straight
21-205A Curved
16 cm

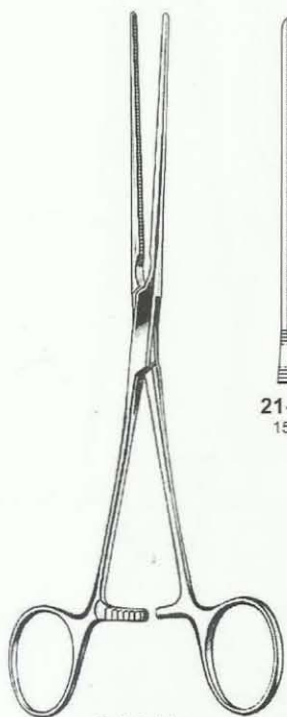

Bainbridge
Straight

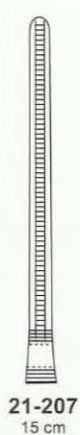

21-207
15 cm

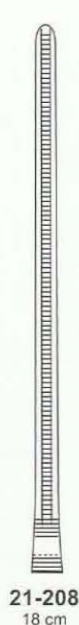

21-208
18 cm

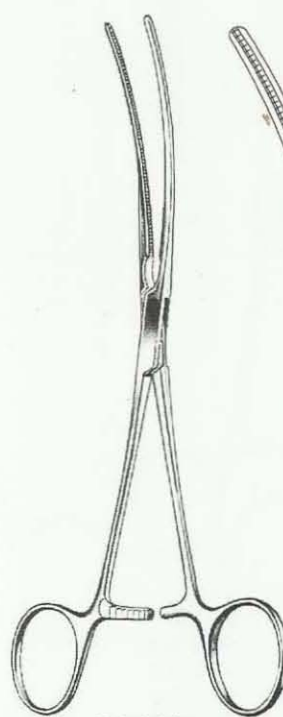

Bainbridge
Curved

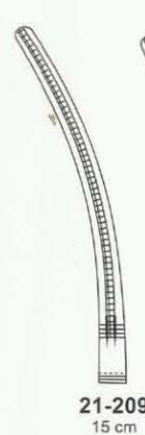

21-209
15 cm

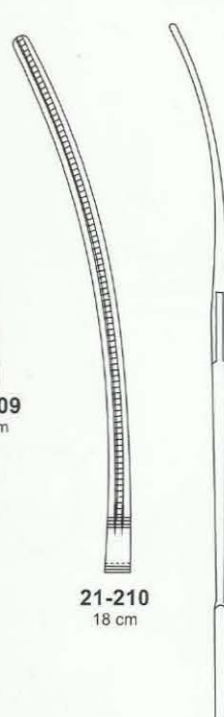

21-210
18 cm



21-211 - 212
DE-BAKEY-KELLY
140 mm

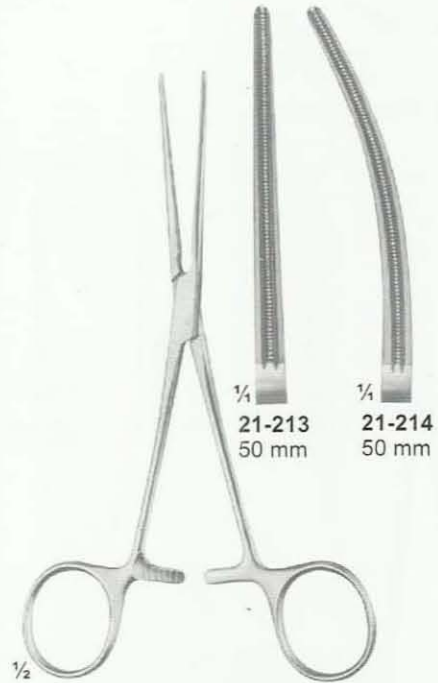

21-213 - 214
PEAN
155 mm

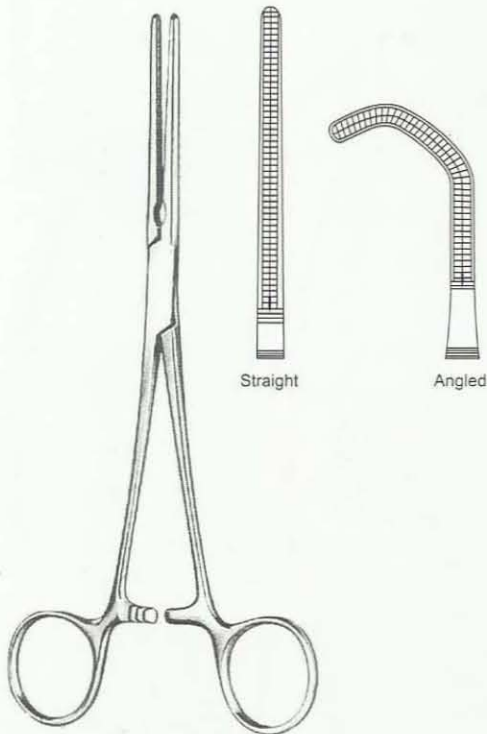

De Bakey-Pean

21-215	16.5 cm	21-220
21-216	18.5 cm	21-220A
21-217	20.5 cm	21-220B
21-218	26 cm	21-220C
21-219	28 cm	21-220D
	Straight	Angled

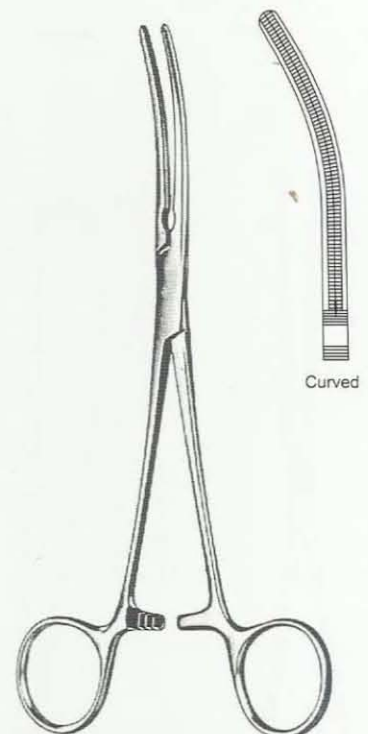

De Bakey-Pean

21-220E	16.5 cm
21-220F	18.5 cm
21-220G	20.5 cm
21-220H	26 cm
21-220J	28 cm

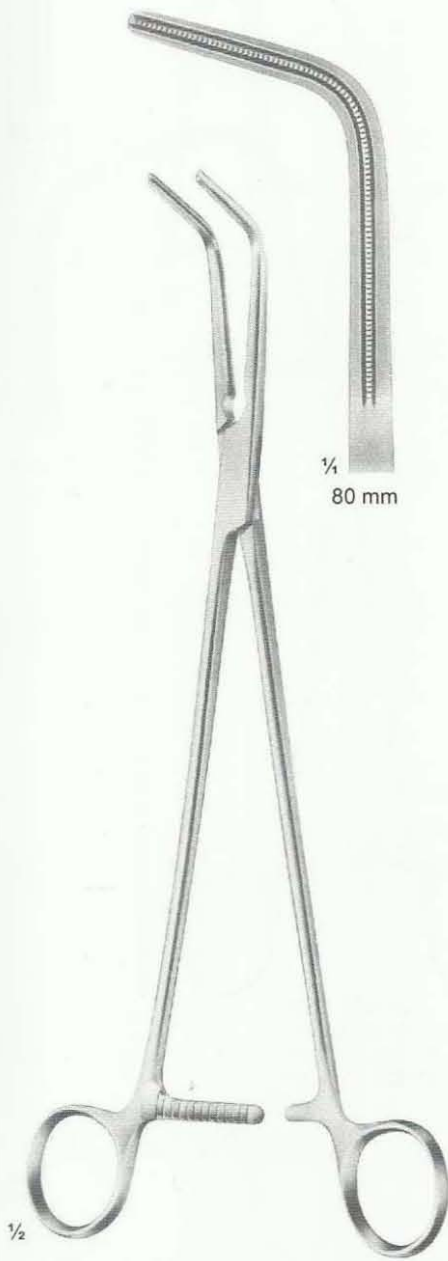

21-221
 DE-BAKEY-MIXTER
 285 mm

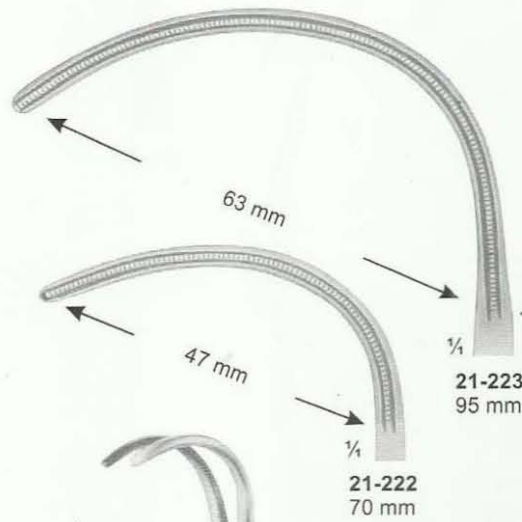

21-222 - 223
 GLOVER
 21-222 195mm
 21-223 210mm

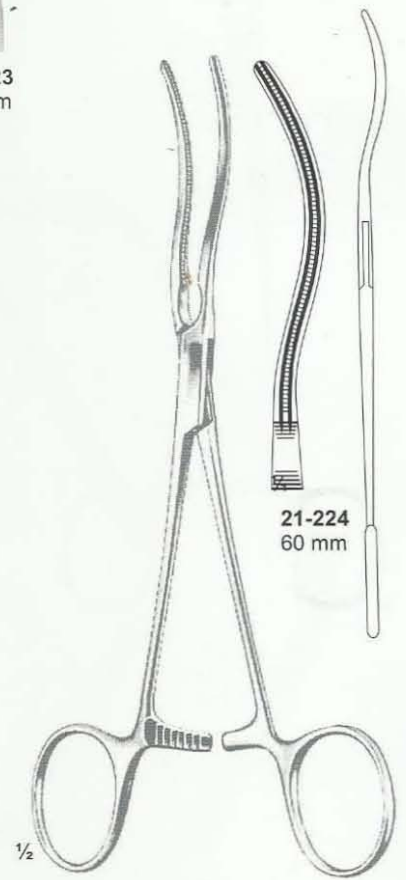

21-224
 GLOVER
 220 mm



21-225
GLOVER
215 mm

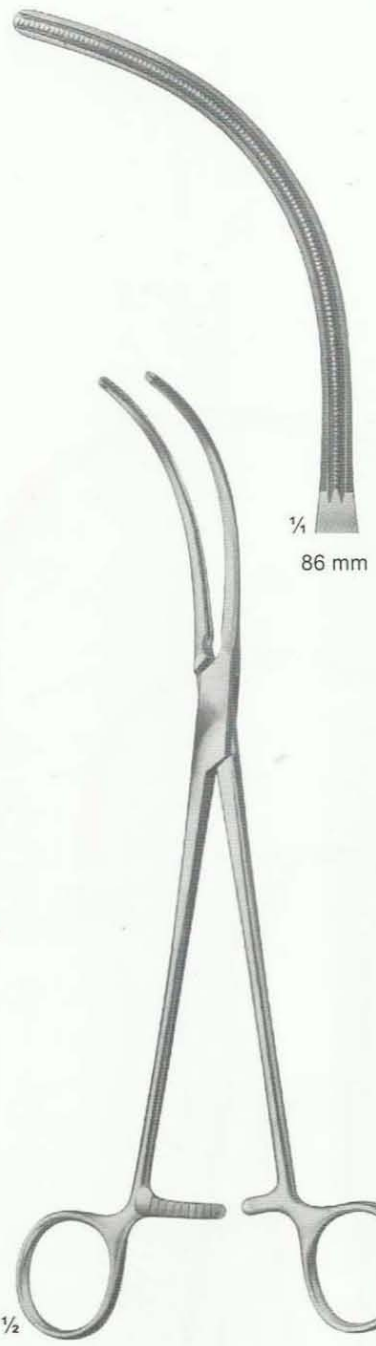

21-226
GLOVER
245 mm

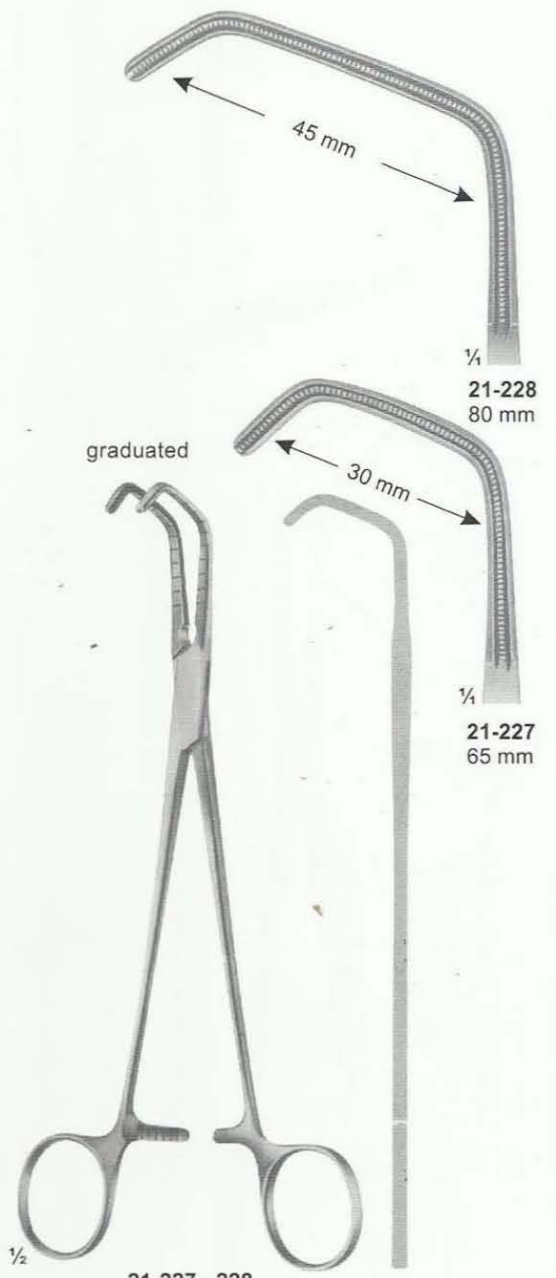

21-227 - 228
DE BAKEY-BECK
21-227 205mm
21-228 210mm



1/4
21-229
86 mm



1/4
21-230
86 mm



1/4
21-231
86 mm

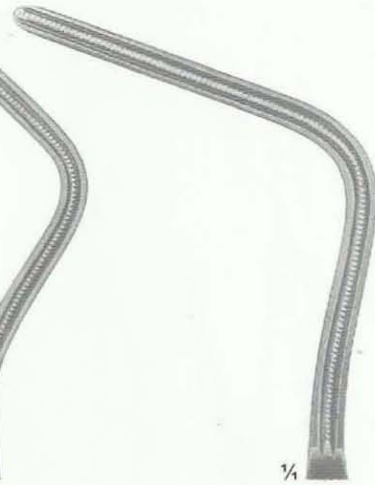

1/4
21-232
86 mm

21-229 - 232
DE BAKEY-HARKEN
21-229 - 255 mm
21-230 - 245 mm
21-231 - 245 mm
21-232 - 245 mm

graduated



21-233 - 337
DE BAKEY

Total Length:

Length of jaws:

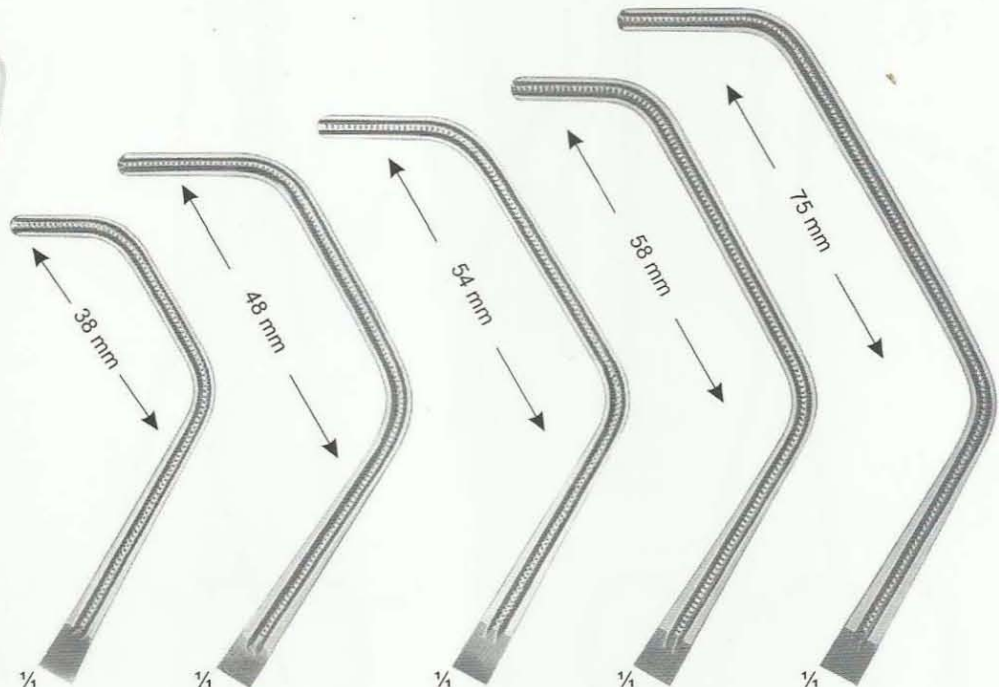

1/4
21-233

1/4
21-234

1/4
21-235

1/4
21-236

1/4
21-237

220 mm

265 mm

270 mm

270 mm

280 mm

85 mm

95 mm

99 mm

103 mm

119 mm

Atraumata Tangential Occlusion And Coarctation Clamps

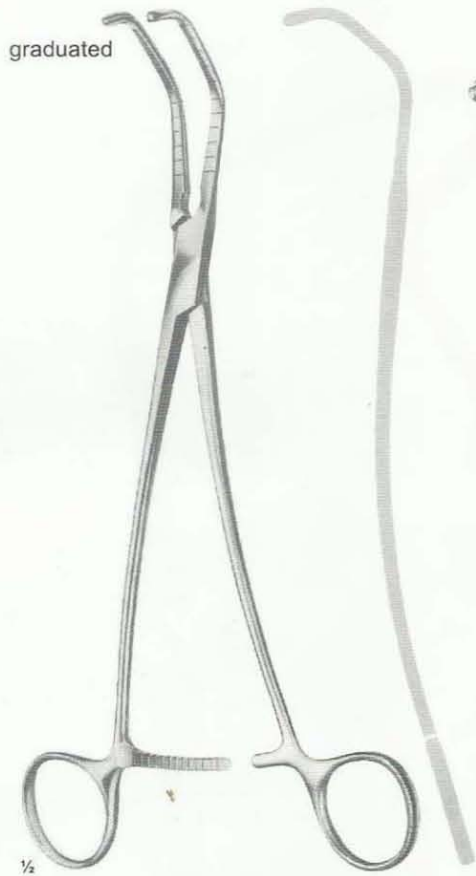

21-238 - 240
DE BAKEY-SATINSKY

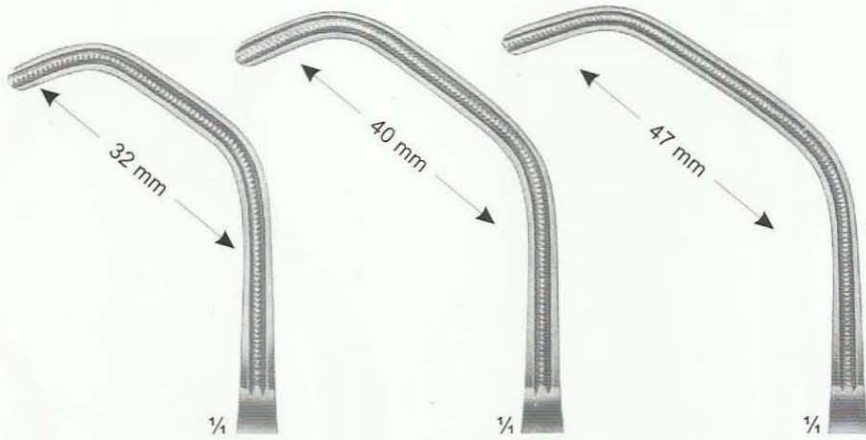

21-238
68 mm
Length 235mm

21-239
76 mm
Length 240mm

21-240
84 mm
Length 245mm



21-241 - 242
DE BAKEY
21-241 170mm
21-242 165mm

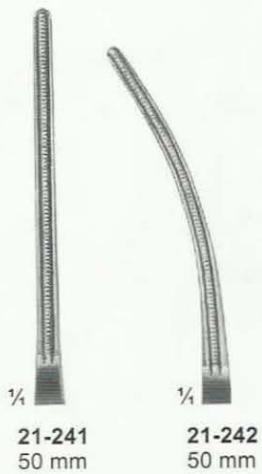

21-243
DE BAKEY
165 mm

Atraumata Coarctation Clamps,
Patent-Ducts Clamps



21-244 - 246
DE BAKAY

21-244 205mm
21-245 225mm
21-246 240mm

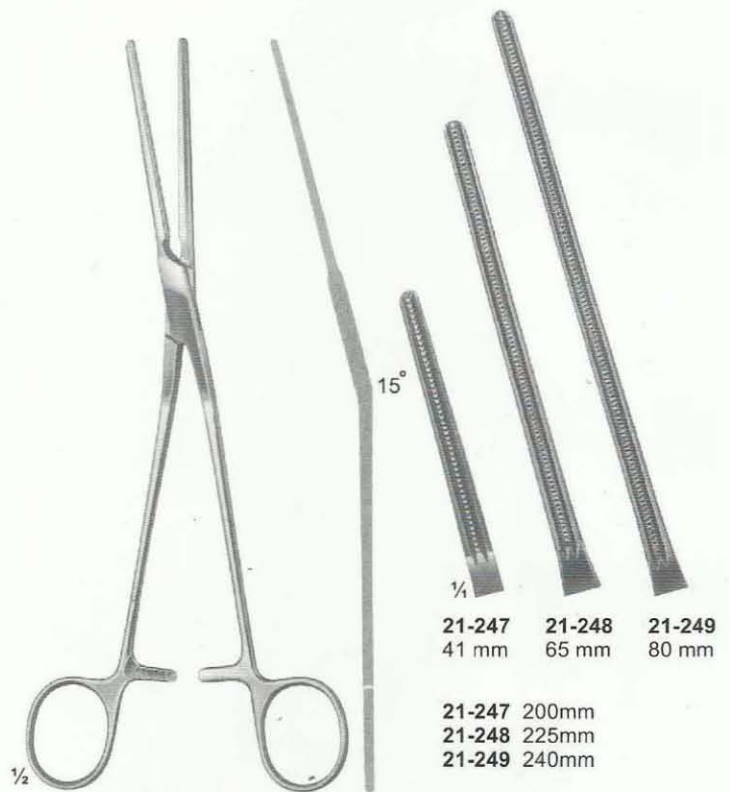

21-247 - 249
DE BAKAY

21-247 200mm
21-248 225mm
21-249 240mm

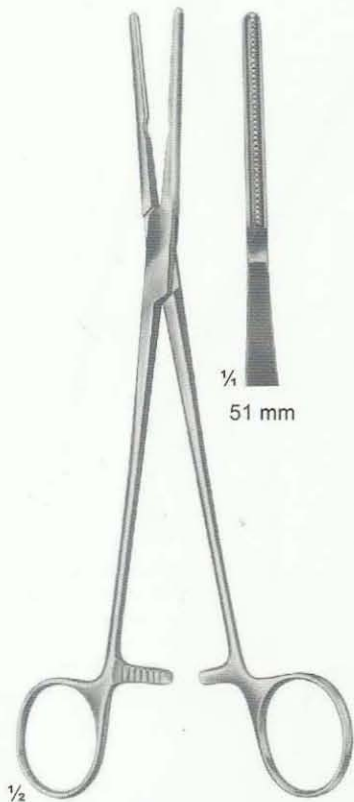

21-250
DE BAKAY
210 mm



21-251
DE BAKAY
210 mm



21-252
DE BAKAY
160 mm

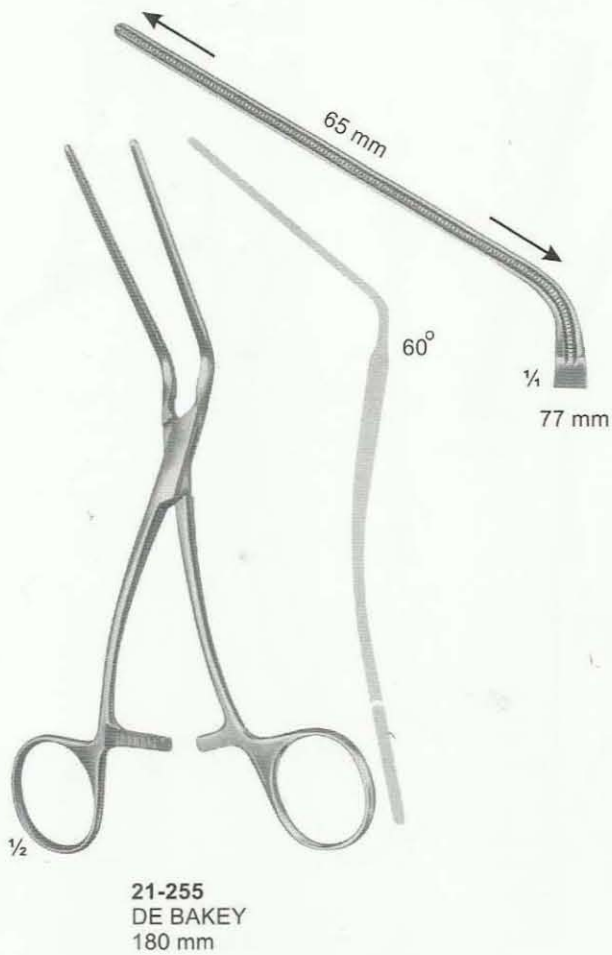
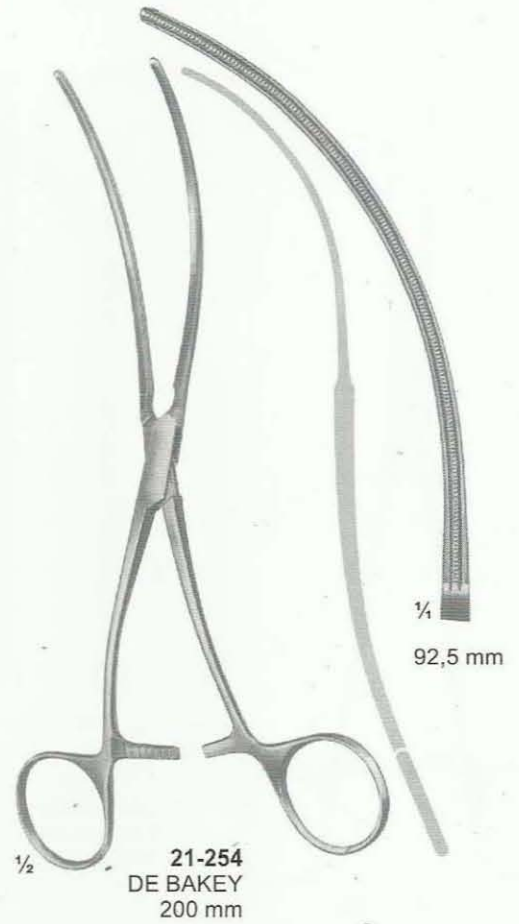



21-258
LELAND-JONES
195 mm



21-259
DE BAKLEY
200 mm

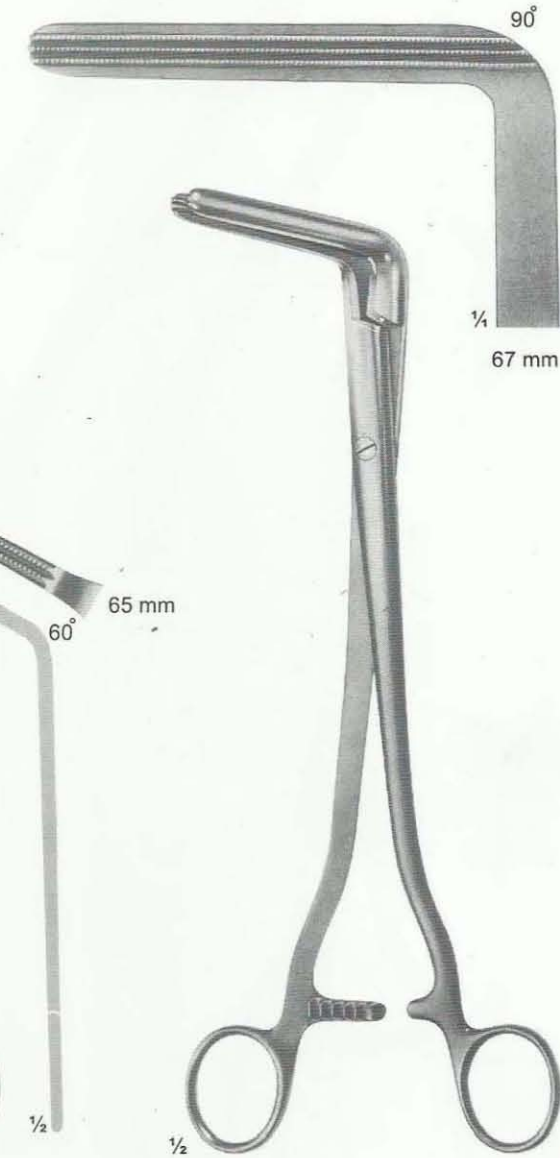

21-260
WERTHEIM
250 mm

Iliac clamp

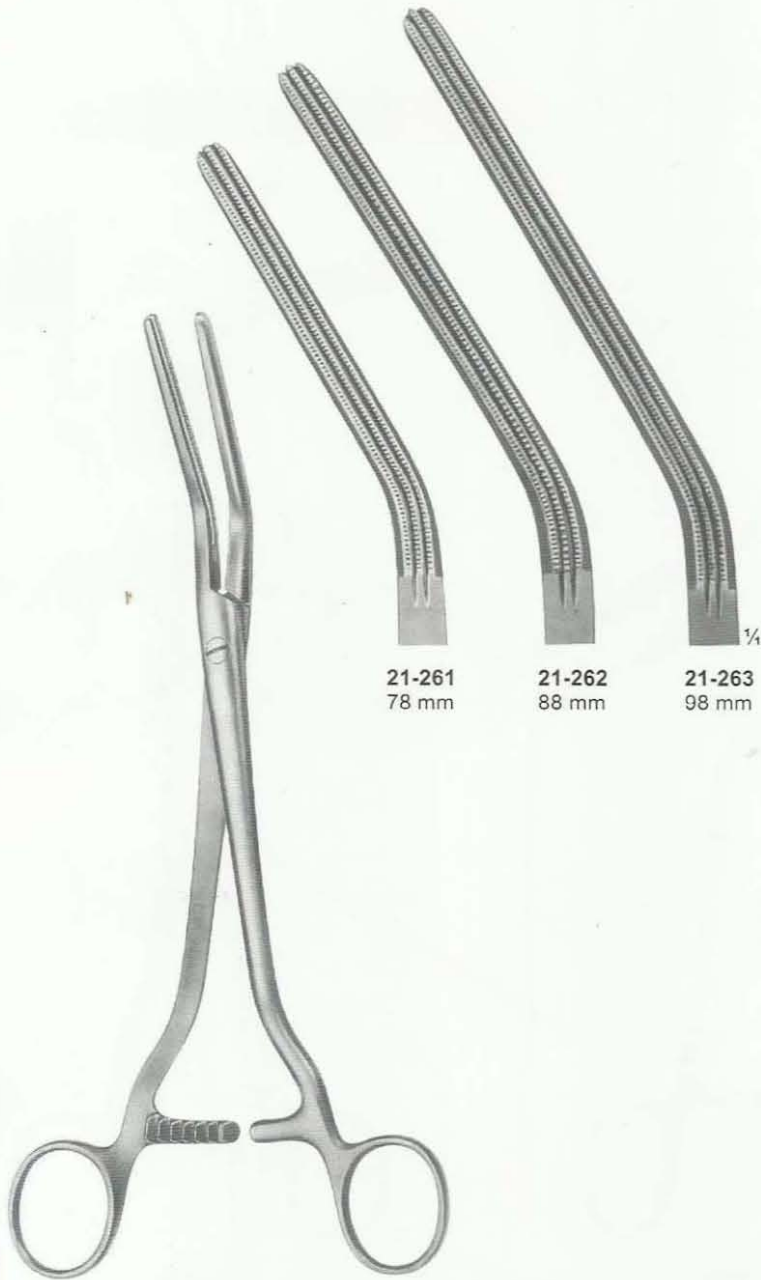

21-261
78 mm

21-262
88 mm

21-263
98 mm

21-261 - 263
DICK
21-261 255mm
21-262 265mm
21-263 275mm



21-264
MORRIS
175 mm

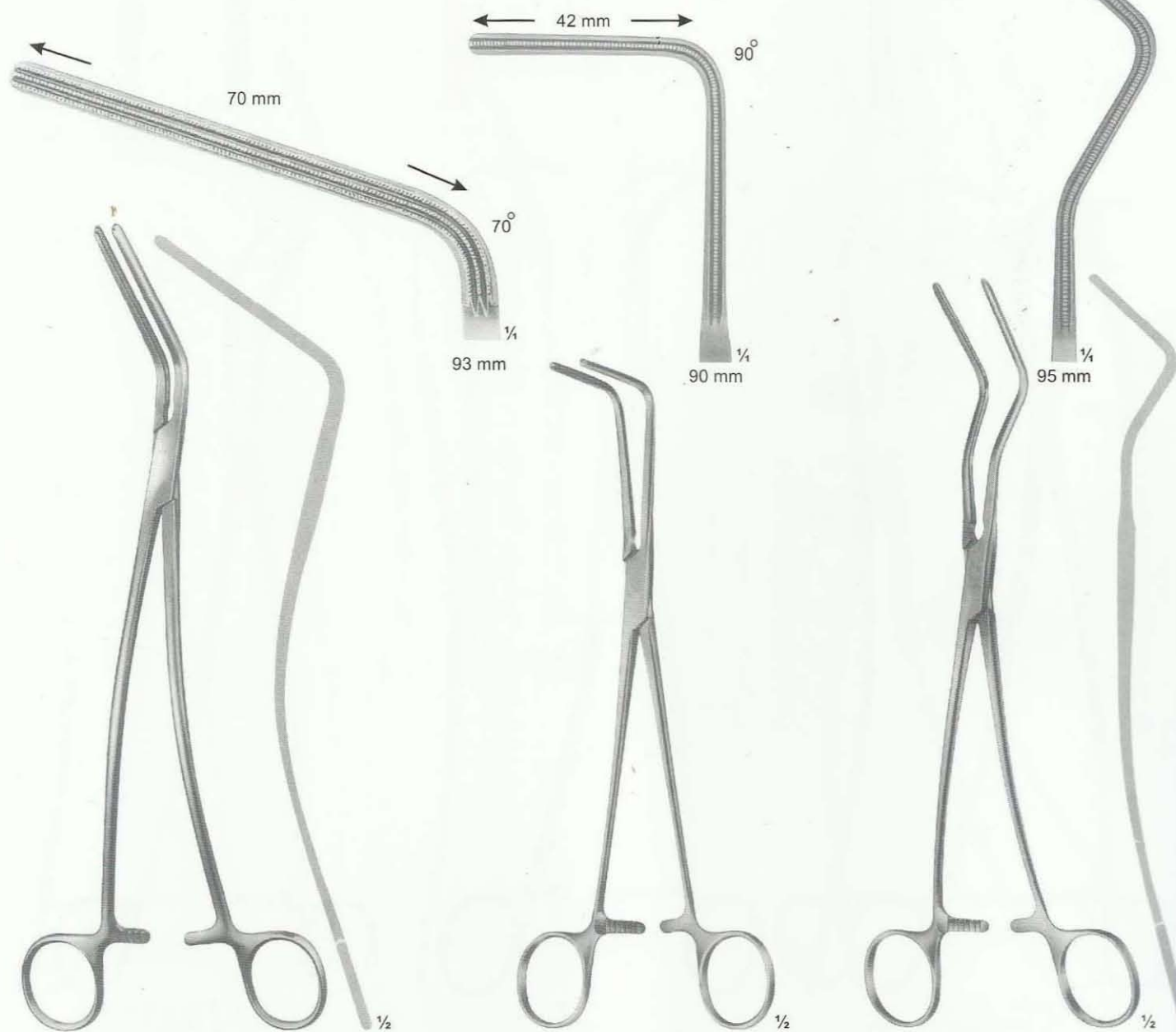

21-265
DE BAKEY (Morris Modif)
240 mm

21-266
LEES
220 mm

21-267
LEES
245 mm

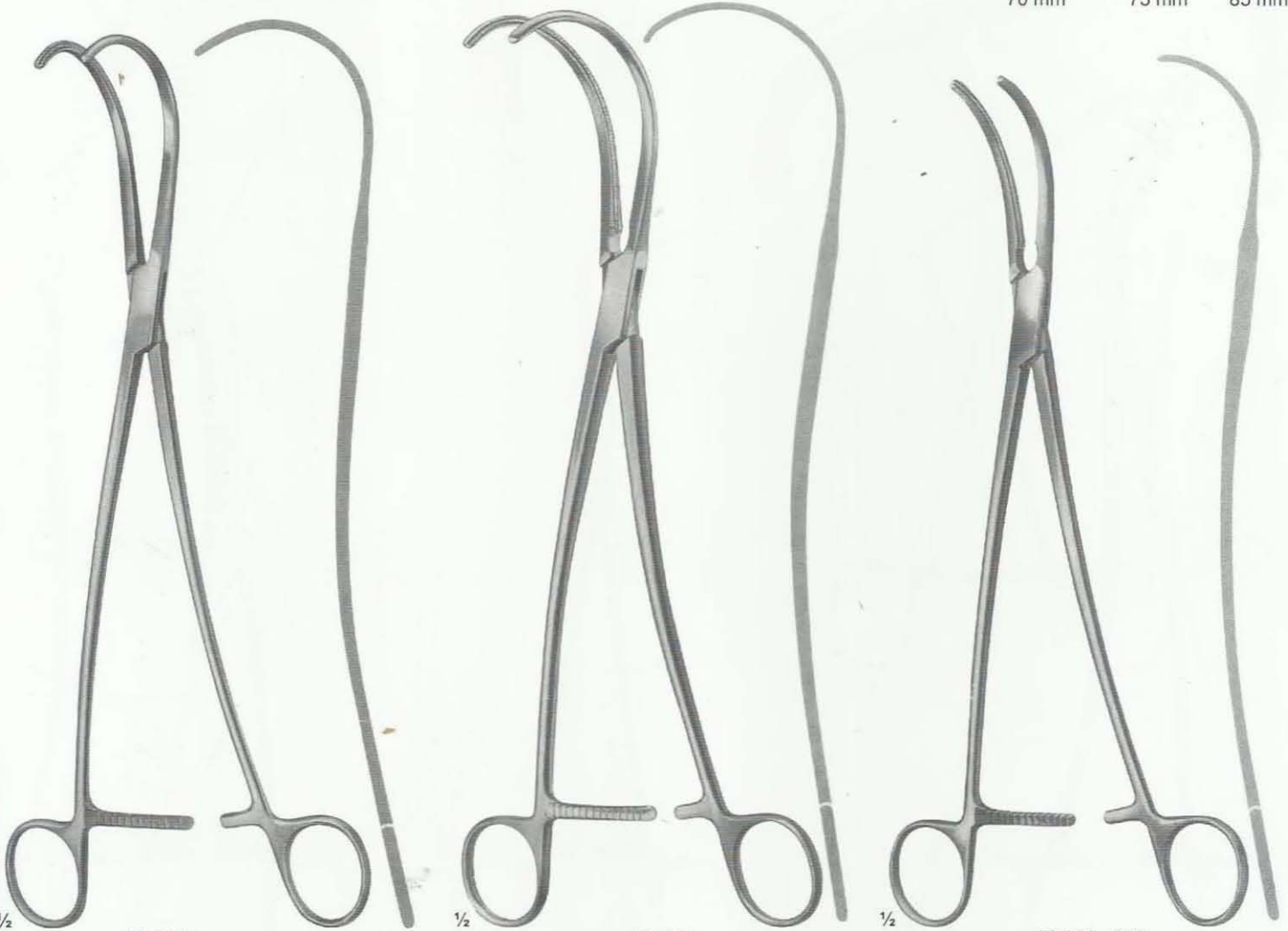
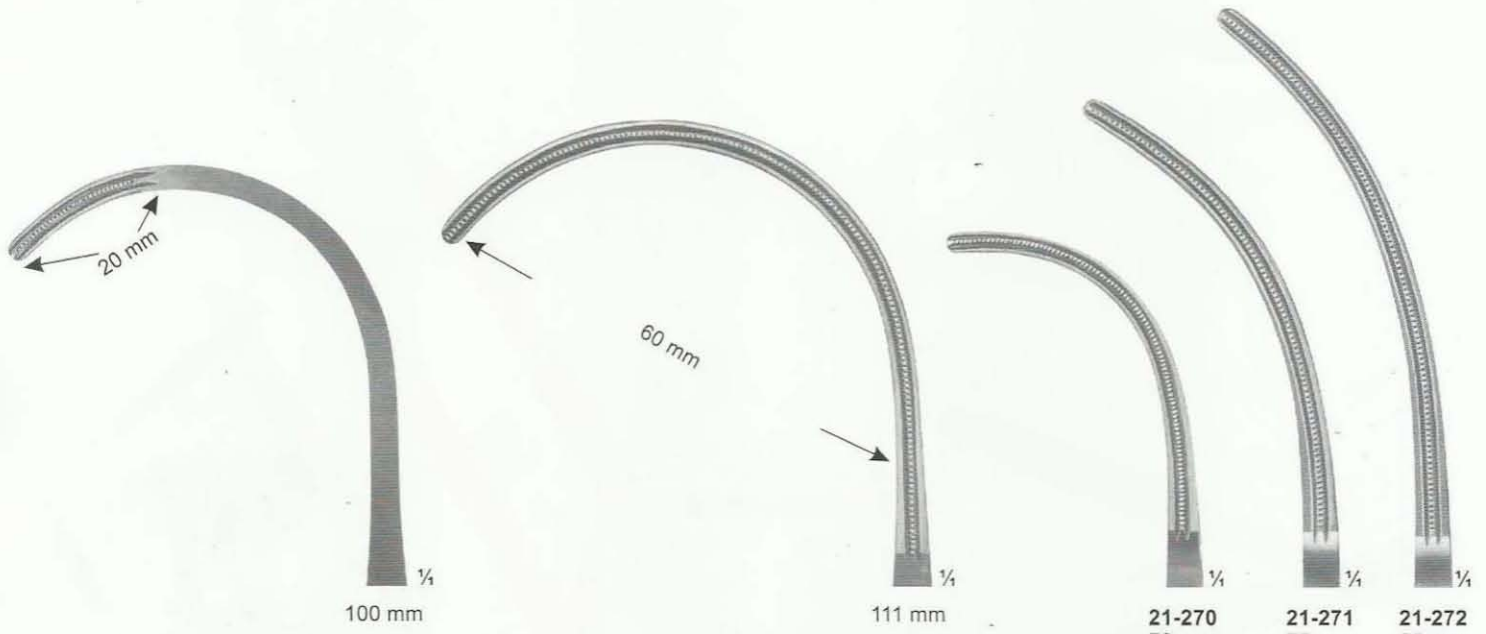

21-268
DE BAKY (Semb modif)
265 mm

21-269
DE BAKY
270 mm

21-270 - 172
DE BAKY
21-270 255mm
21-271 265mm
21-272 280mm

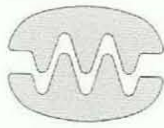

2:3 Teeth Rows



21-273	21-274	21-275	21-276
95 mm	110 mm	130 mm	140 mm

21-273 - 276
DE BAKY
21-273 250mm
21-274 300mm
21-275 315mm
21-276 330mm

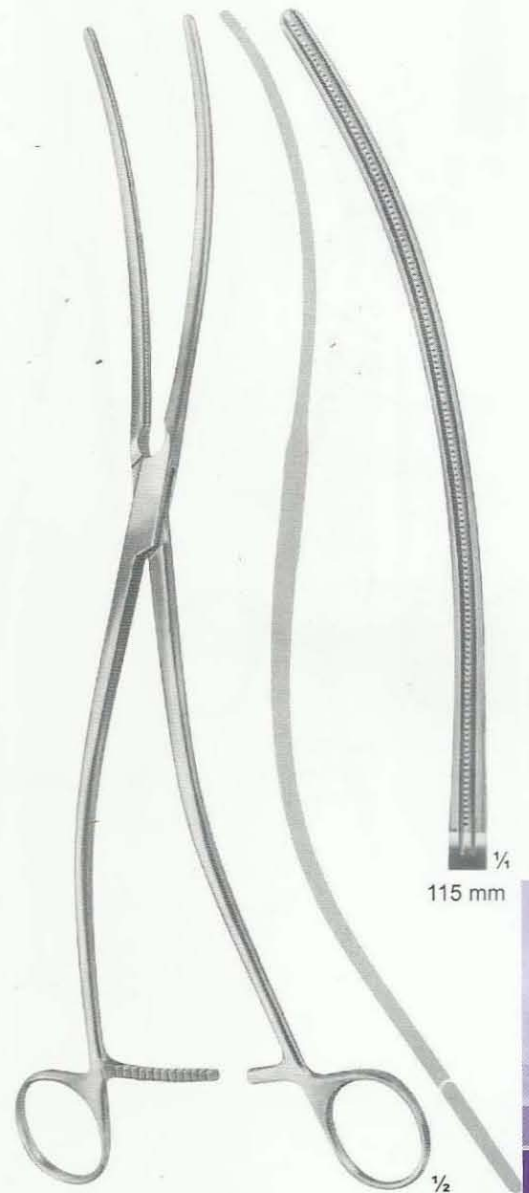

1/4
115 mm

21-277
DE BAKY
300 mm



21-278
DIETRICH
210 mm

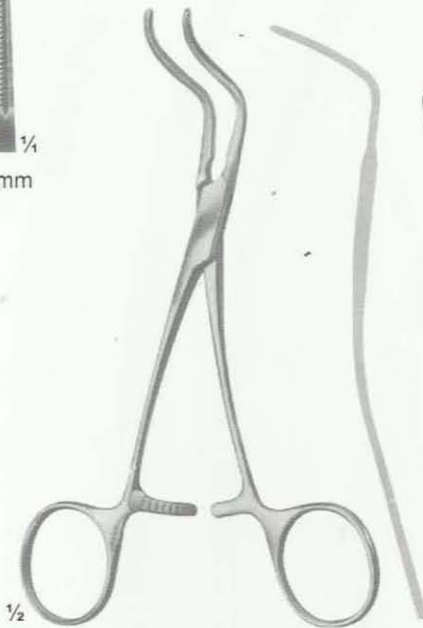

21-279
SUBRAMANIAN(Modif)
155 mm



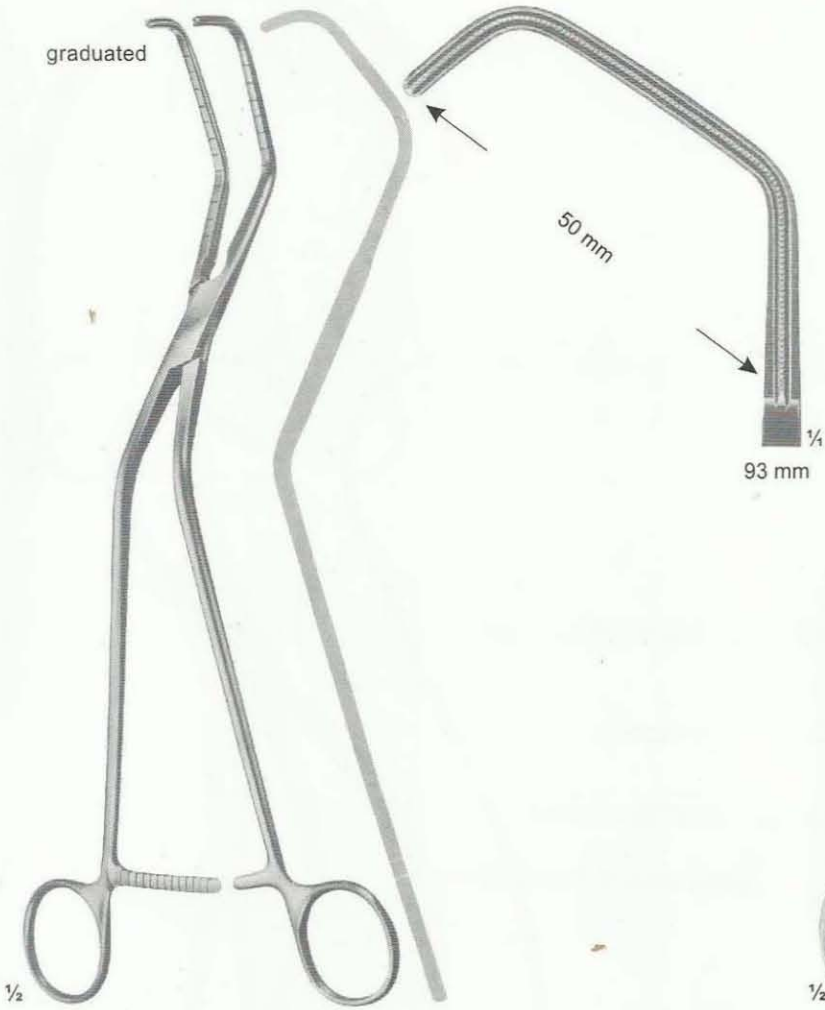

21-280
OCHSNER
260 mm



21-281
DE BAKAY
265 mm

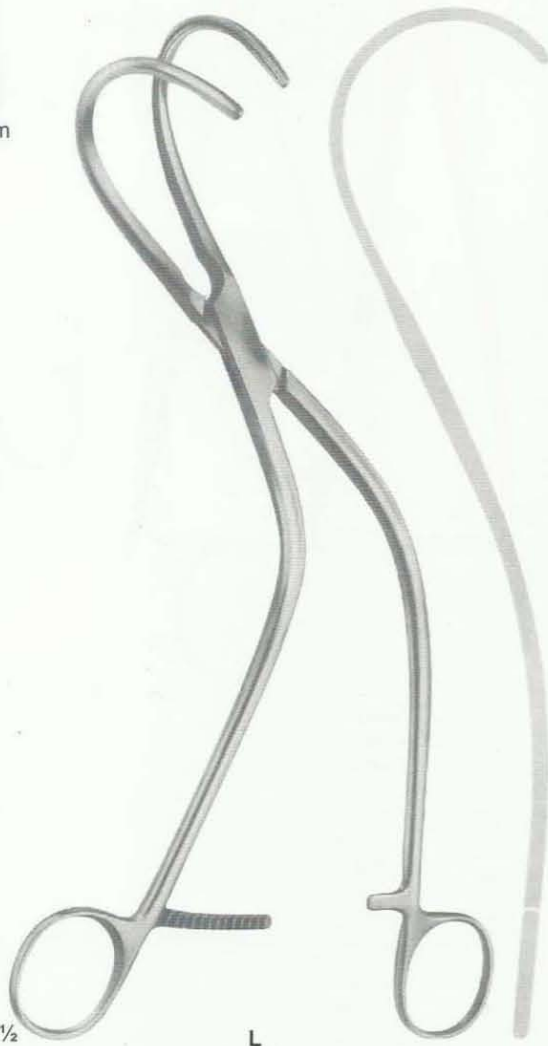
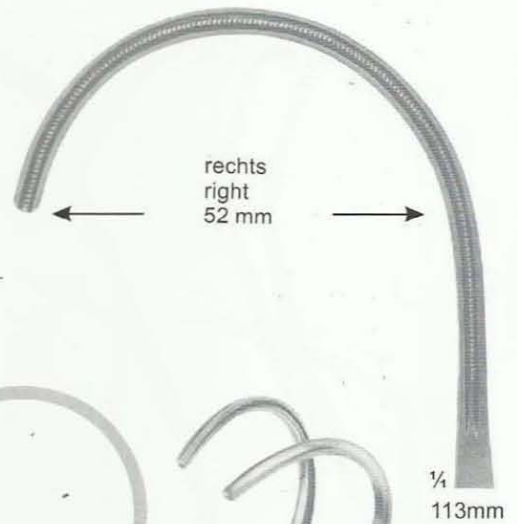
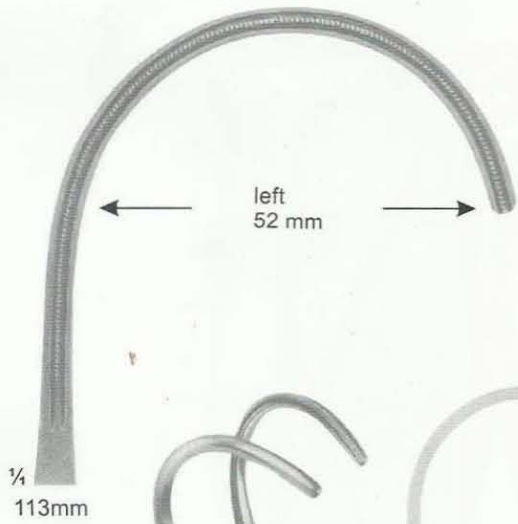

L
21-282
WEBER
260 mm

R
21-283
WEBER
260 mm



21-284 - 287
DE BAKEY

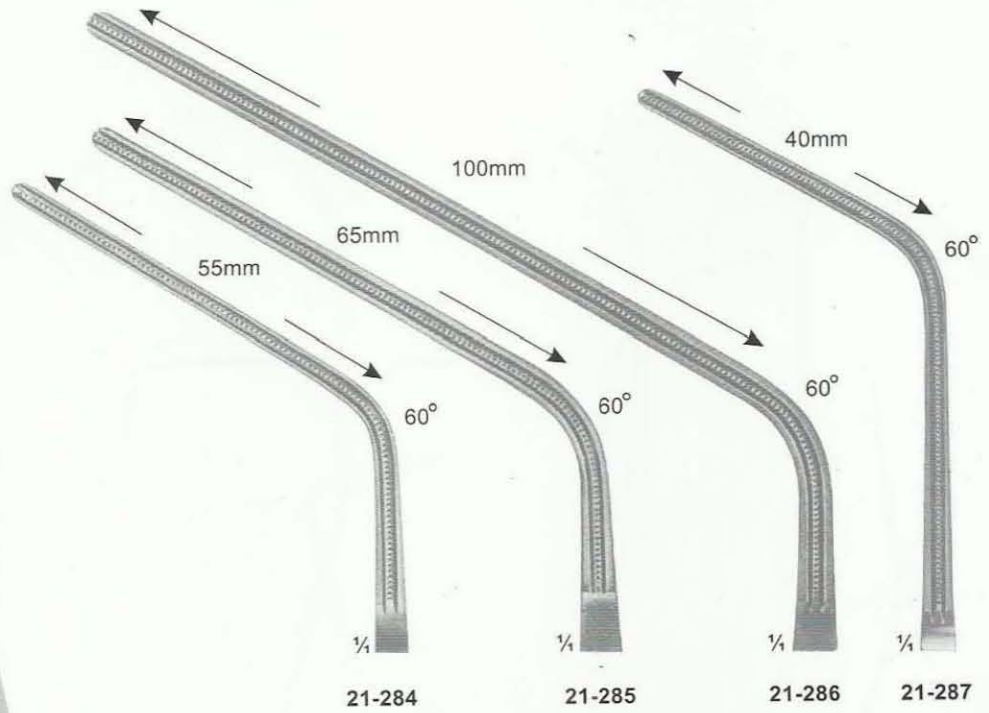

Total Length:	230 mm	280 mm	305 mm	240 mm
Length of jaws:	85 mm	100 mm	135 mm	93 mm



21-288 - 291
DE BAKEY

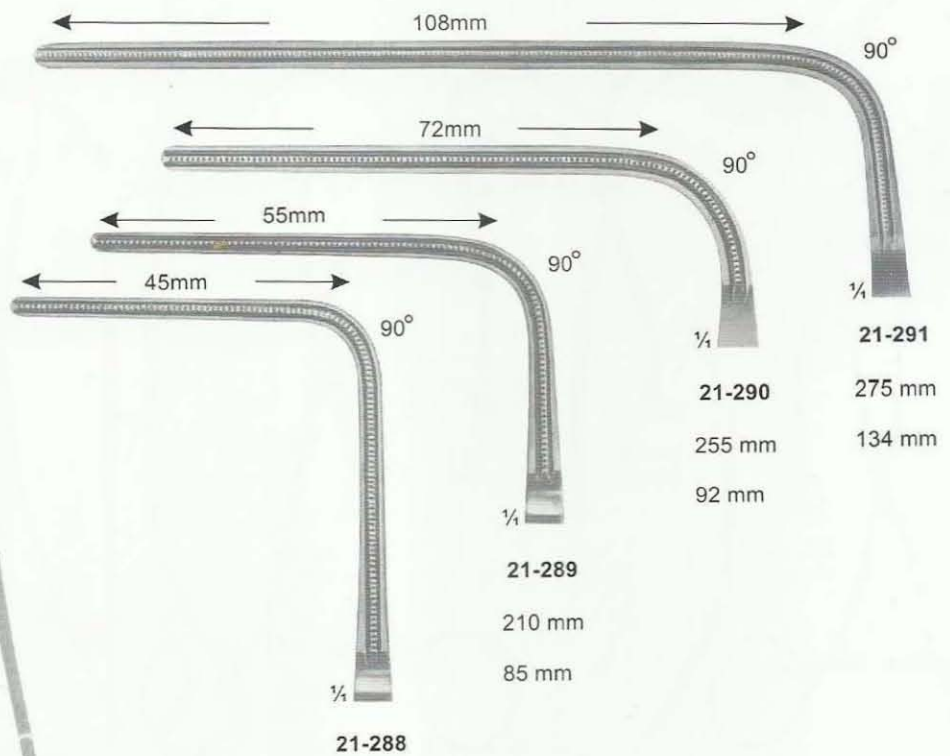

Total Length:	225 mm
Length of jaws:	93 mm

Ring Handle Bulldog Clamps
Anastomosis Clamps, Pediatric Types

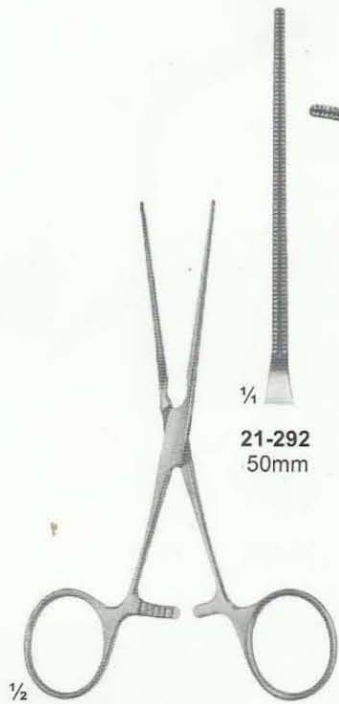

21-292
50mm



21-293
50mm



21-294
COOLEY
100 mm

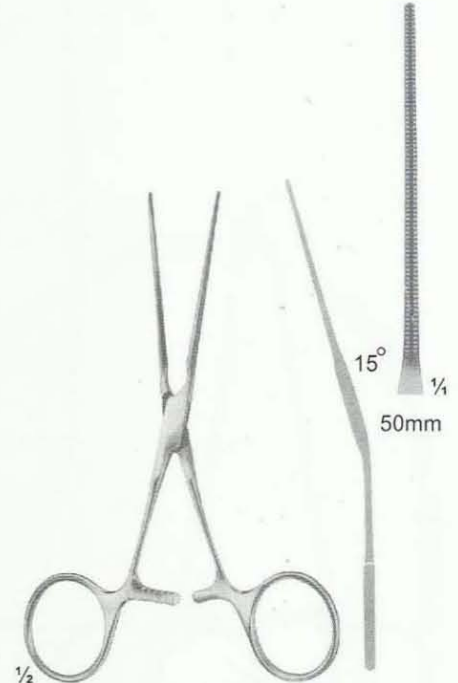

21-295
COOLEY
125 mm

21-292 - 293
COOLEY
125 mm, 115 mm

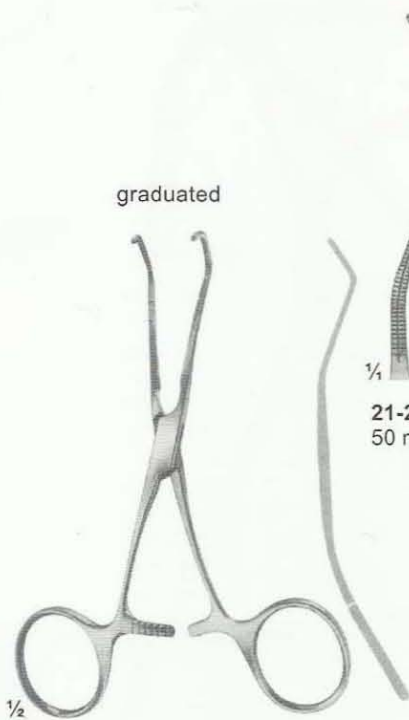

21-296 - 297
COOLEY
120 mm, 115 mm

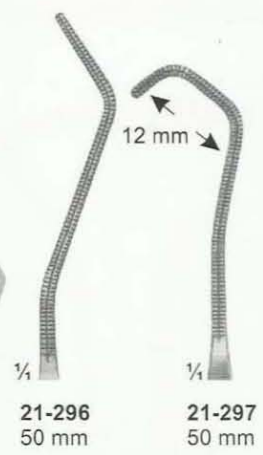

21-297
50 mm



21-298 - 299
COOLEY-BECK
150 mm, 155 mm

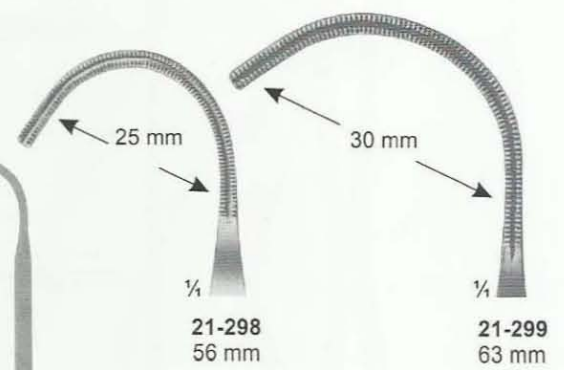

21-299
63 mm

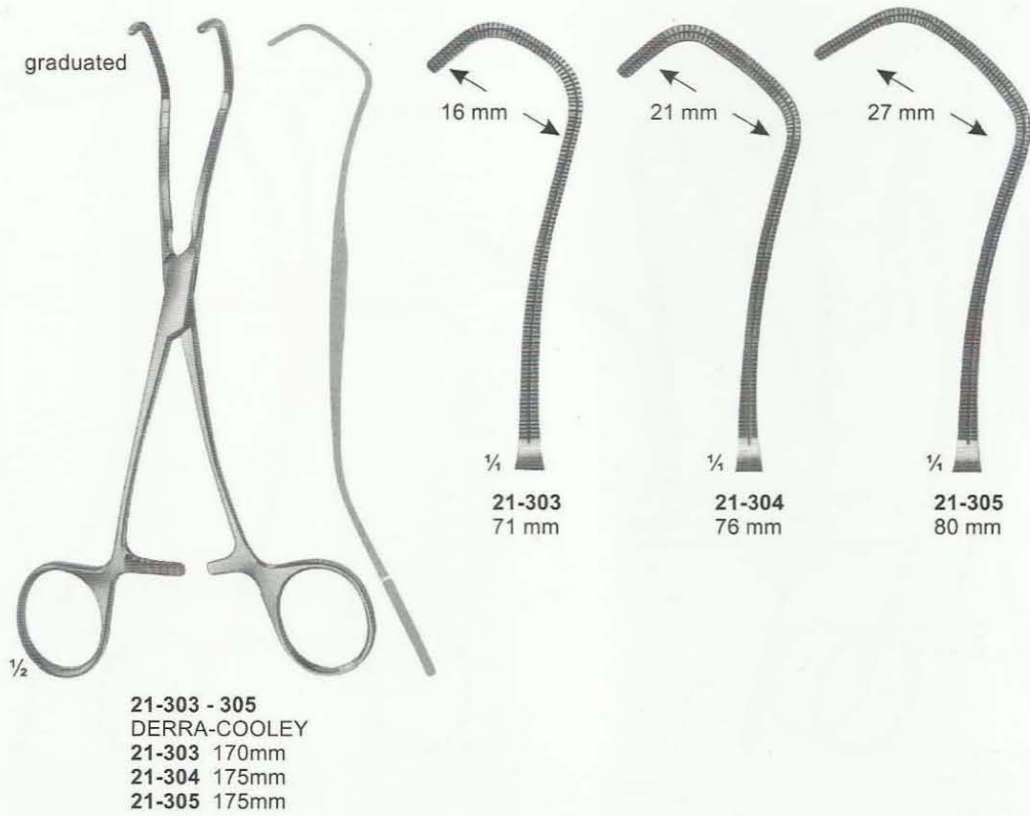
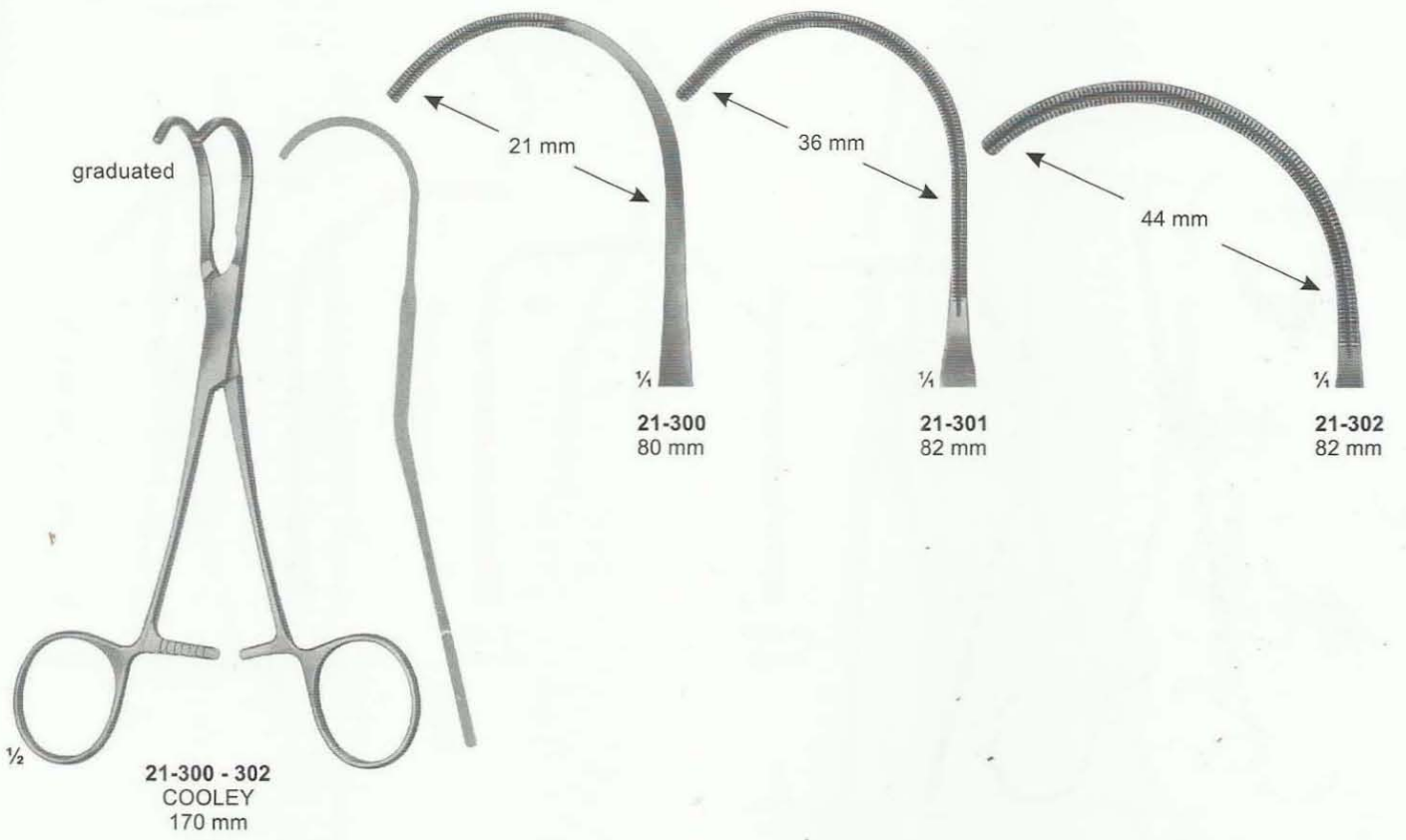

Anastomosis Clamps Multi-Purpose Clamps Pediatric Types

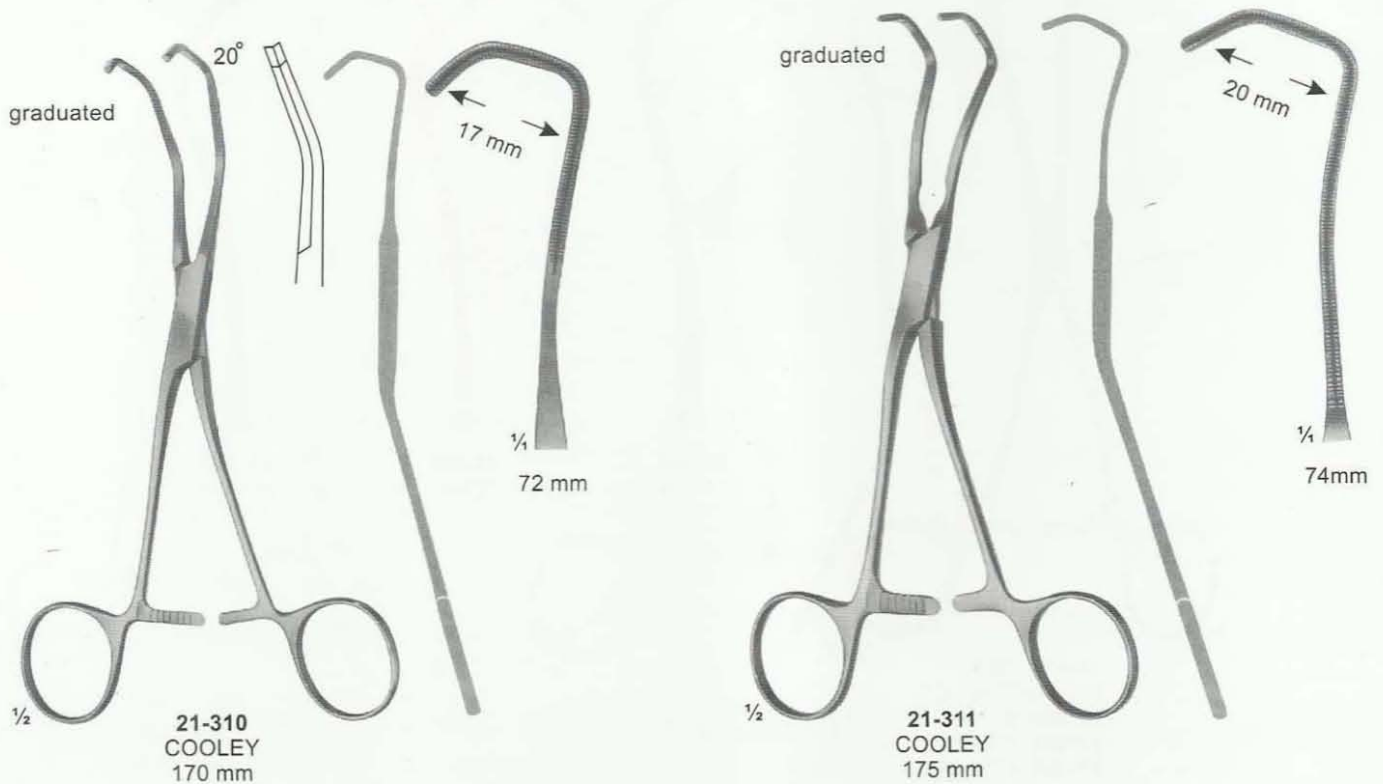
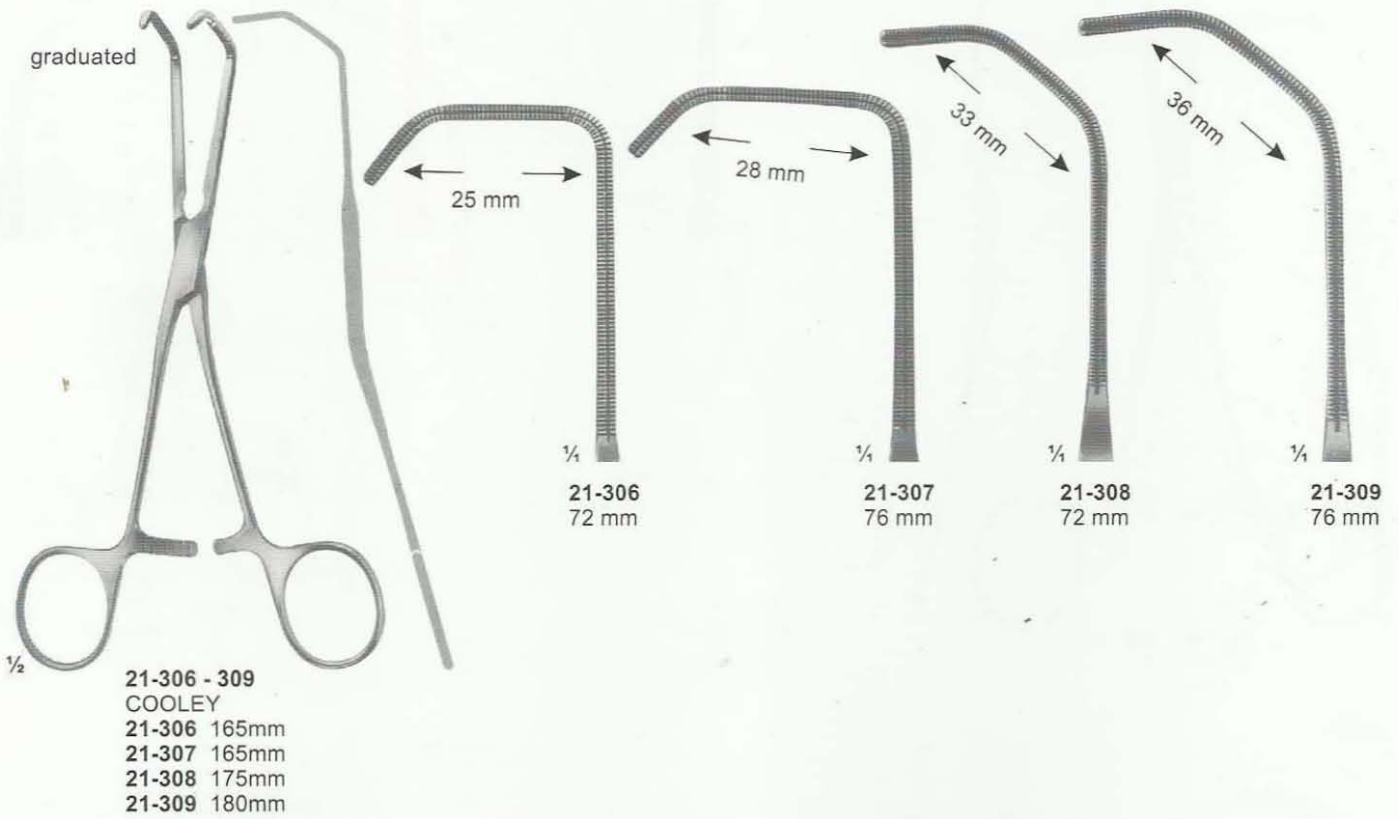

graduated

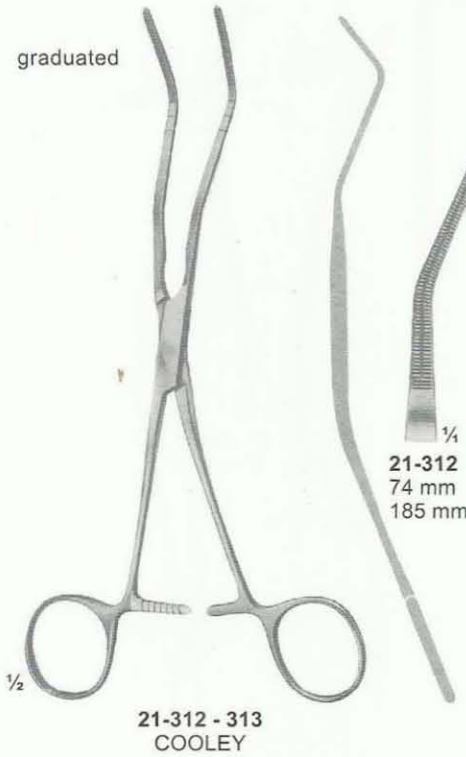

graduated

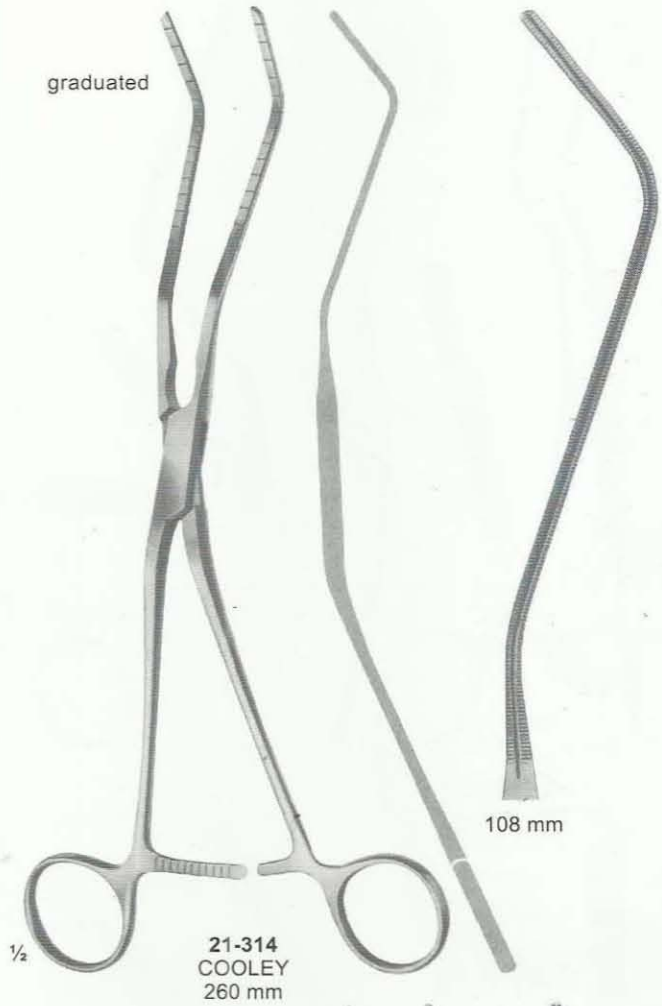

graduated

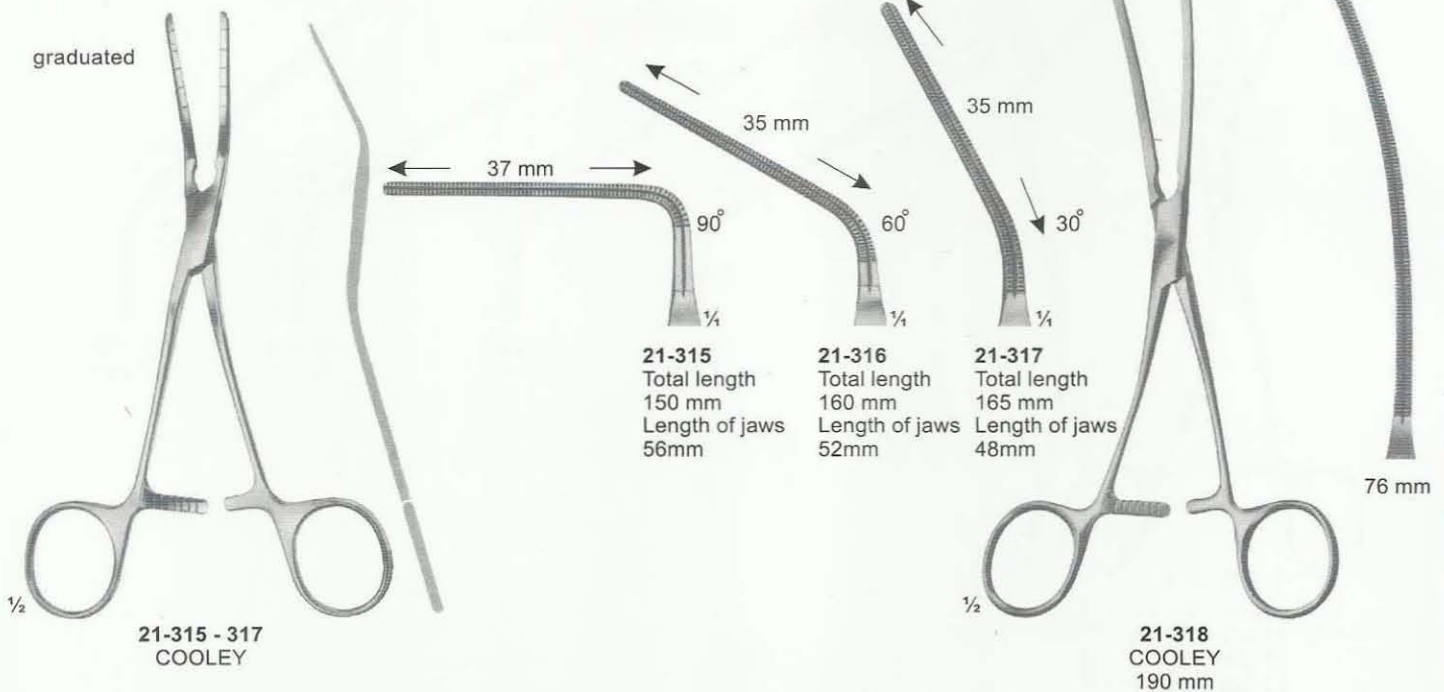

Atraumata Aorta Clamps, Patent-Ductus Clamps, Coarctation Clamps Pediatric Types

graduated

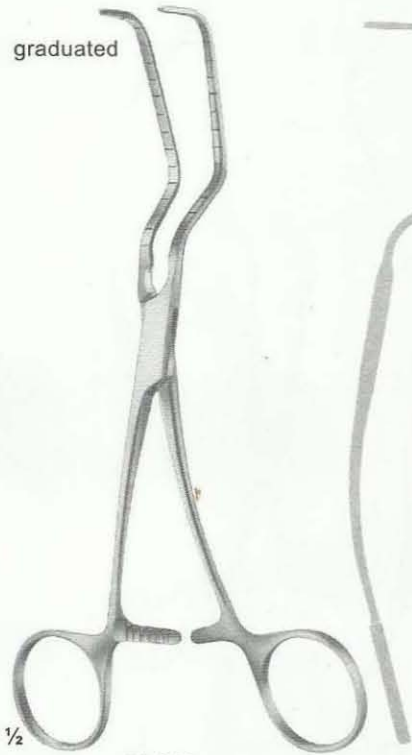

21-319
PARRY-COOLEY
185 mm



1/4
92 mm



21-320 - 325
COOLEY
21-320 160mm
21-321 170mm
21-322 180mm
21-323 180mm
21-324 180mm
21-325 160mm

21-320 41 mm
21-321 52 mm
21-322 62 mm
21-323 52 mm
21-324 63 mm

21-325 56 mm

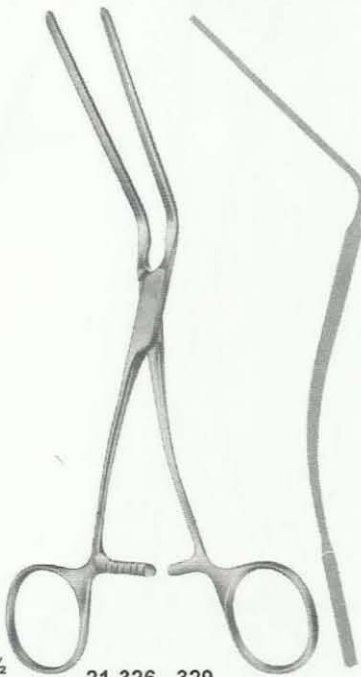

21-326 - 329
21-326 165mm
21-327 170mm
21-328 185mm
21-329 185mm

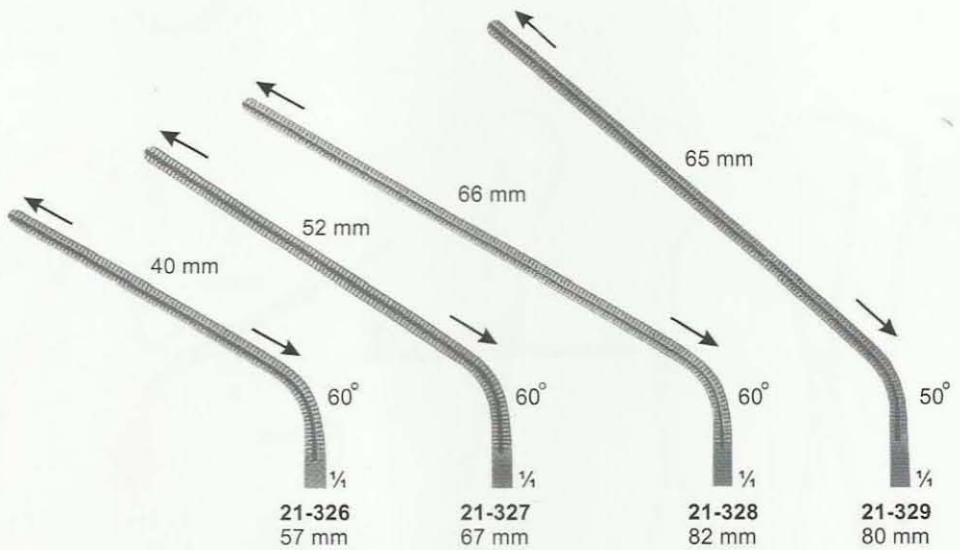

21-326 57 mm

21-327 67 mm

21-328 82 mm

21-329 80 mm



- 21-330 - 339
DARDIK
- | | | | |
|--------|--------|--------|--------|
| 21-330 | 150 mm | | |
| 21-331 | 150 mm | 21-335 | 170 mm |
| 21-332 | 150 mm | 21-336 | 170 mm |
| 21-333 | 145 mm | 21-337 | 170 mm |
| 21-334 | 130 mm | 21-338 | 160 mm |
| | | 21-339 | 135 mm |

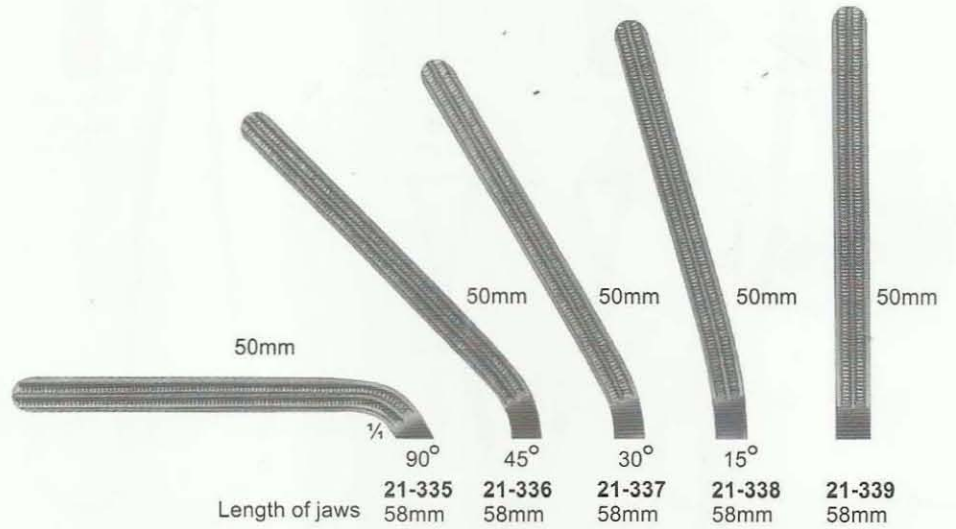
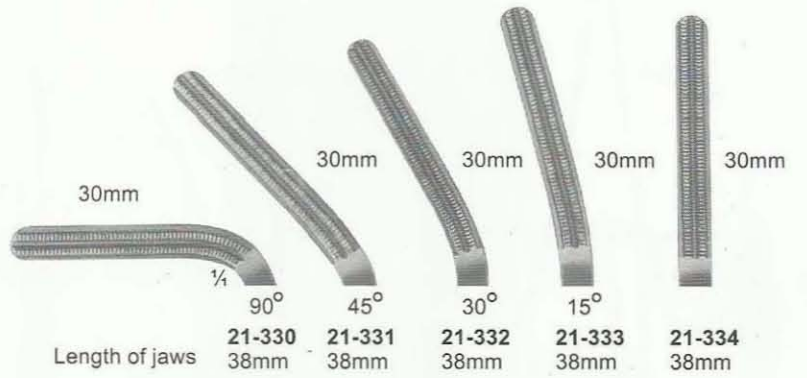

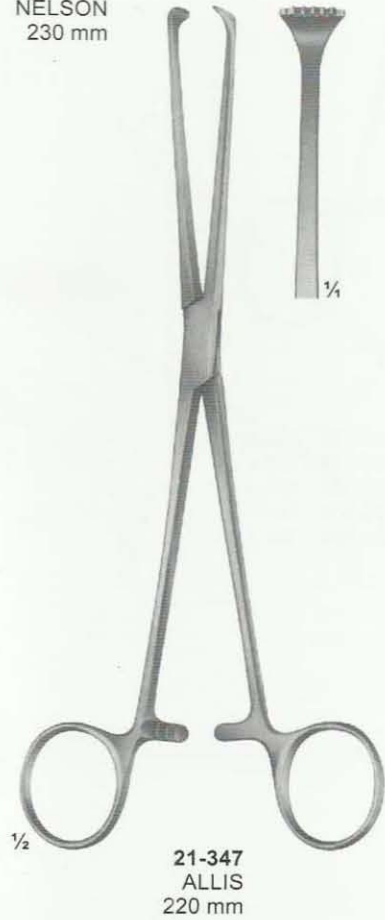
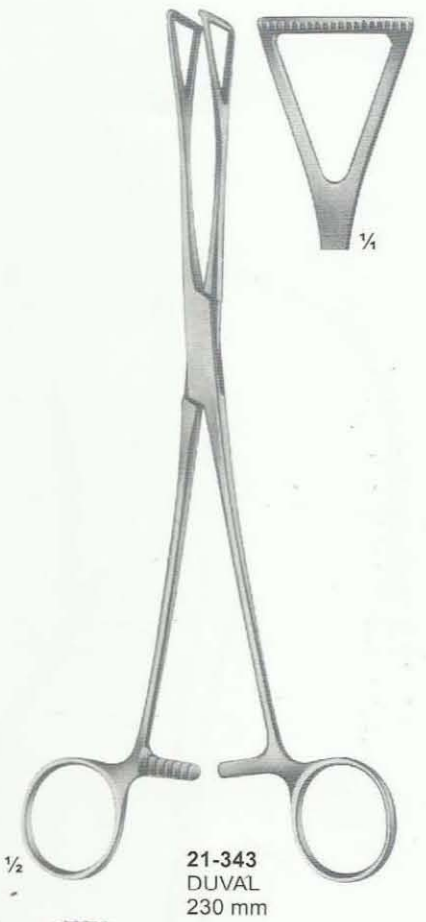



21-348
FINOCHIETTO
245 mm



21-349 - 350
SEMB
240 mm

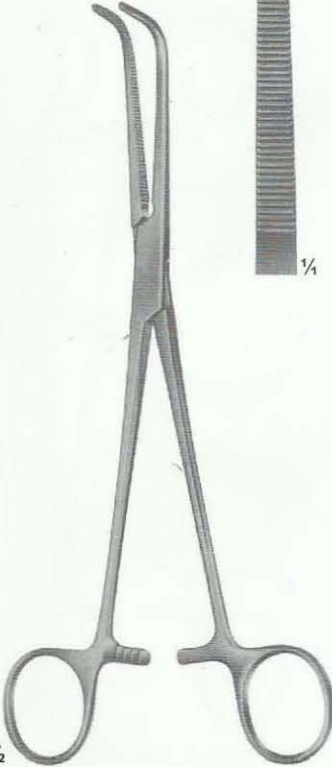
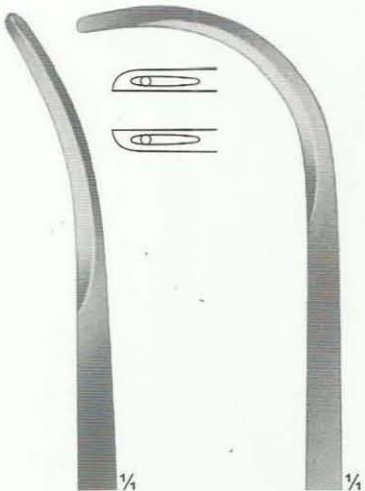

21-351
WIKSTROEM
205 mm

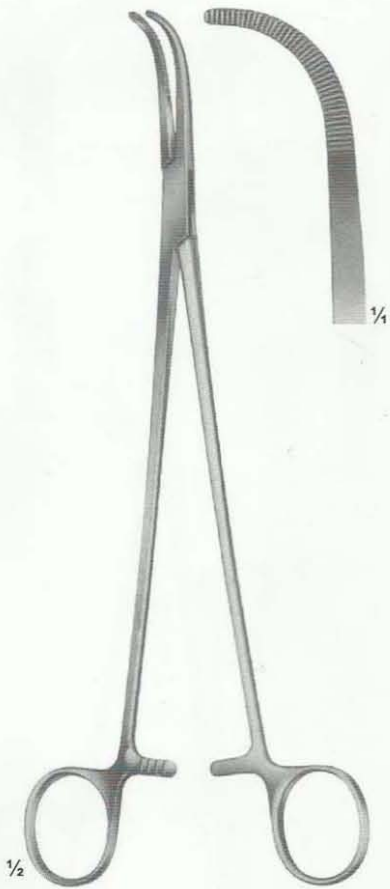

21-352
MIXTER
230 mm

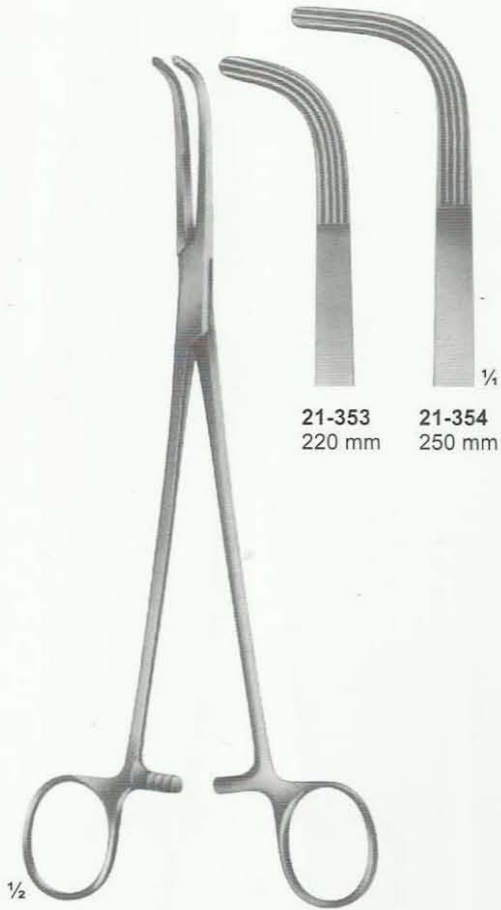

21-353 - 354
MIXTER

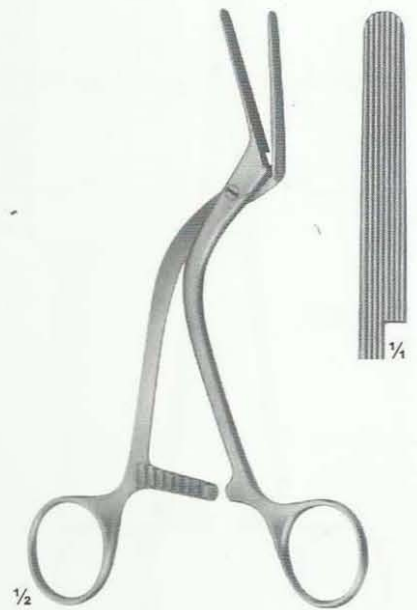

21-355
HOEPFNER
Vessel clamp
160 mm



21-356
SATINSKY
Anastomosis clamps
265 mm

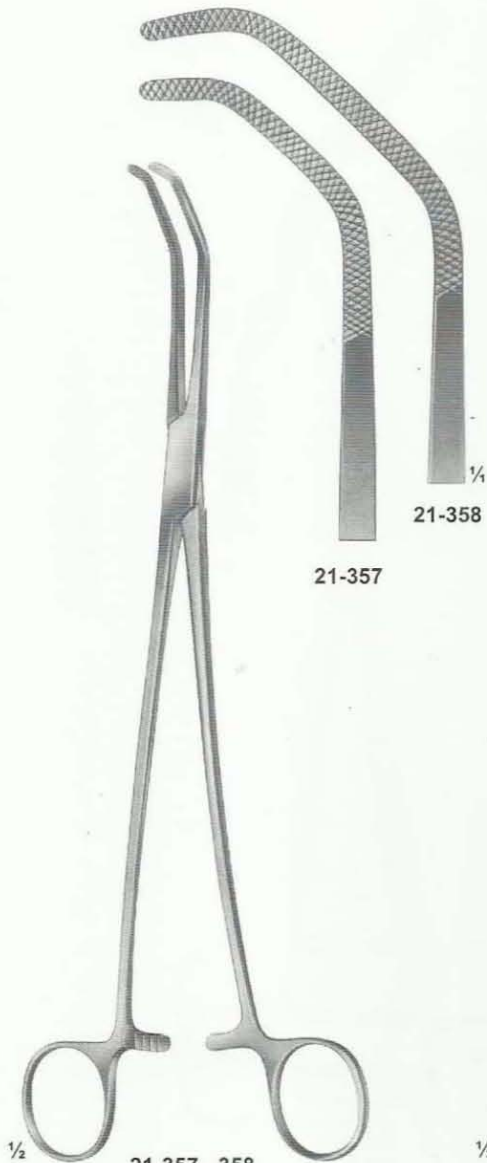

21-357

21-358

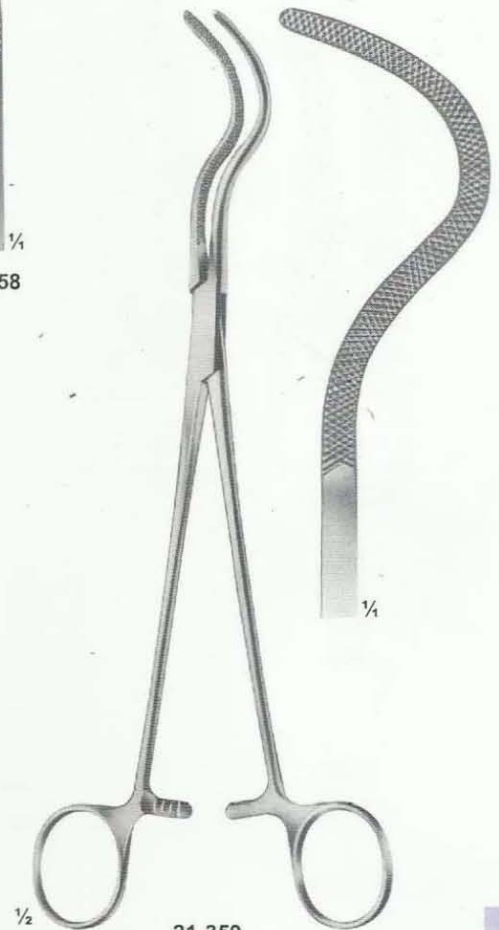

21-359
HARKEN
Anastomosis clamps
240 mm



21-360
PERTUISET
Carotid Clamp
90 mm

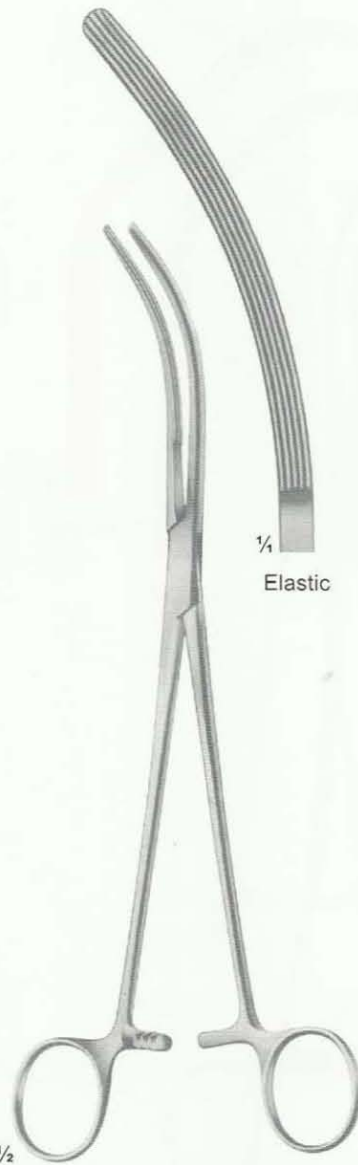

21-361
CRAFOORD-SELLORS
240 mm

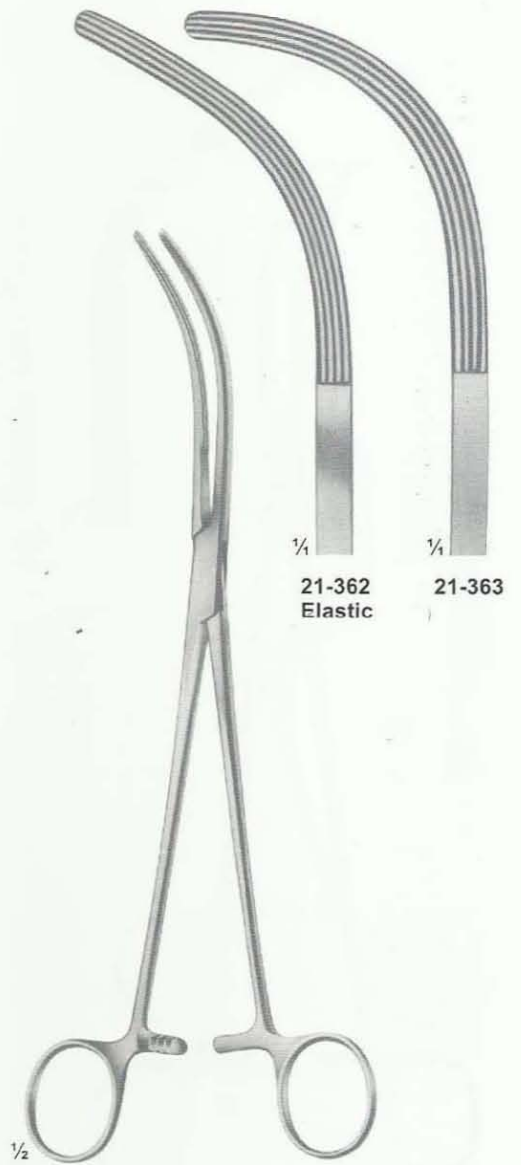

21-362 - 363
CRAFOORD
240 mm



$\frac{1}{2}$
21-364
PRICE THOMAS
225 mm



$\frac{1}{2}$
21-365 - 366
PRICE THOMAS
225 mm

$\frac{1}{4}$
21-365
jaws with pins

$\frac{1}{4}$
21-366
jaws with pins



21-367
SCHUMACHER
Sternum shears
210 mm



21-368
LEBSCHE
Sternum chisel
200 mm



21-369^r
230 mm



21-370
COLLIN
195 mm



21-371
GLUCK
190 mm



21-372
BETHUNE
340 mm



21-373
BRUNNER
Universal Pattern
340 mm



21-374
GIERTZ-STILLE
250 mm



21-375
SEMB
Rib-and Bone
Holding forceps
190 mm



21-376
SEMB
Rib-and Bone
Holding forceps
190 mm

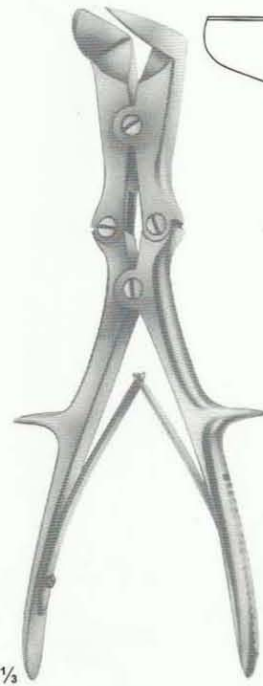

21-377
LISTON-STILLE
265 mm

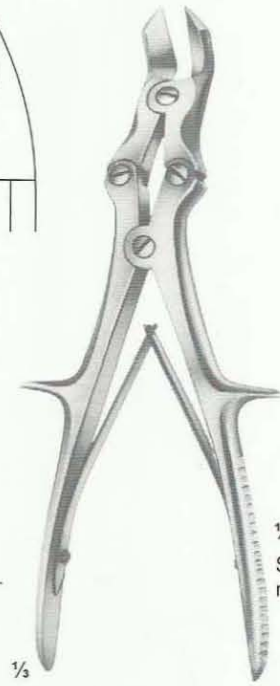
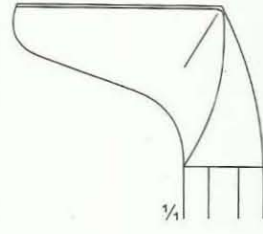

21-378
LISTON-KEY-HORSLEY
(Tudor Edwards)
255 mm



S-shaped for posterior rib ends.

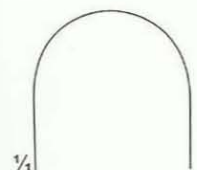

21-380



21-381



21-380 - 381
SAUERBRUCH-CORYLLOS
Rib rongeurs to shorten
the rib stumps
310 mm

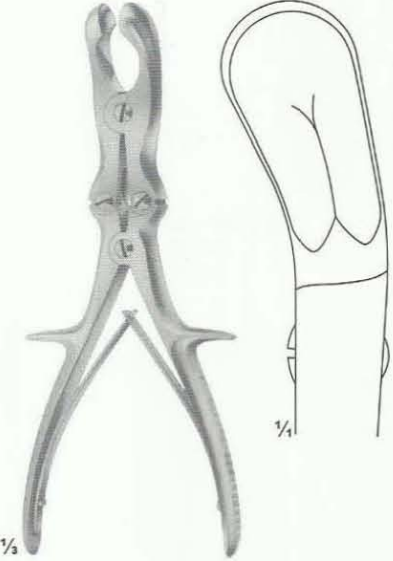

21-379
SEMB
Rib Rongeur to shorten
the rib stumps
240 mm

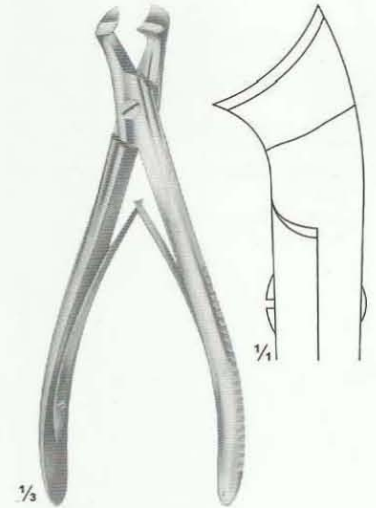

21-382
MARKWALDER
Rib Rongeur to Round
the rib stumps
190 mm

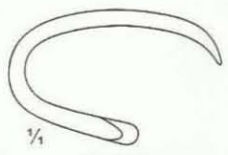

21-383



21-384



1/2

21-383 - 384
DOYEN
for children
175 mm



21-385



21-386



1/2

21-385 - 386
DOYEN
for adults
175 mm

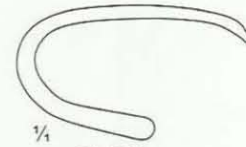

21-387

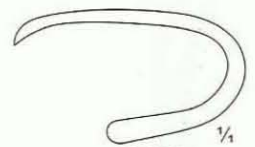

21-388



1/2

21-387 - 388
DOYEN
240 mm

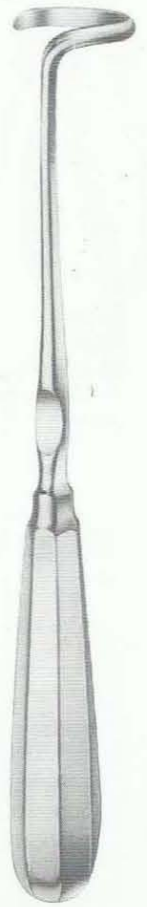



1/2

21-389 - 393
SEMB
230 mm

12 mm

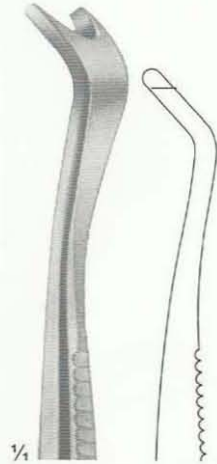

21-389
190 mm

12 mm

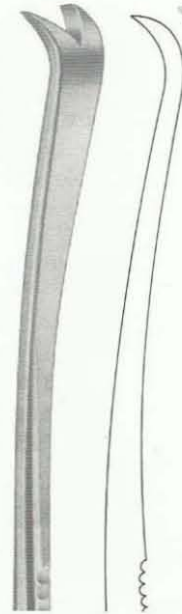

21-390
230mm

13 mm

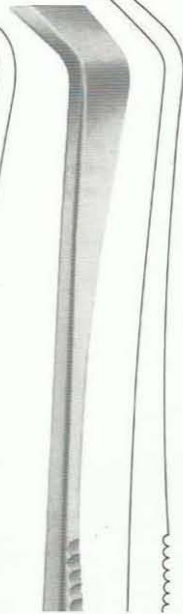

21-391
230mm

13 mm



21-392
230mm

15 mm

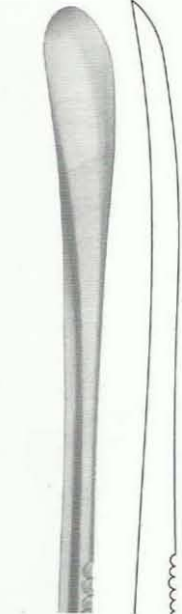

21-393
230mm

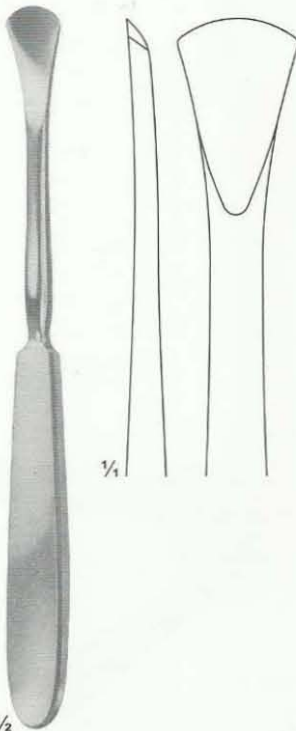

1/4

1/2

21-394
LANGENBECK
190 mm

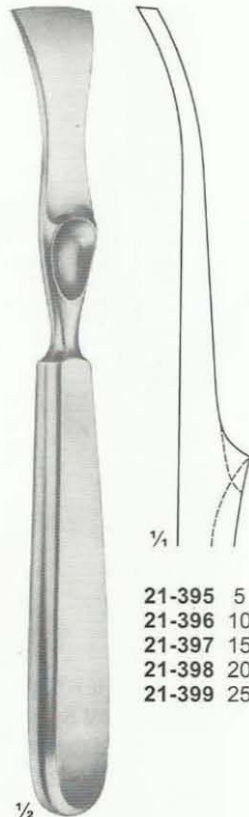

1/4

1/2

21-395 - 399
LAMBOTTE
215 mm

- 21-395 5 mm
- 21-396 10 mm
- 21-397 15 mm
- 21-398 20 mm
- 21-399 25 mm

10mm

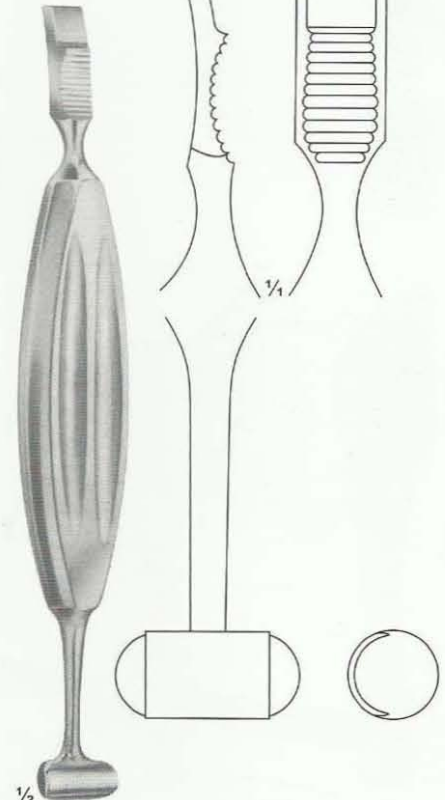

1/4

1/2

21-400
ALEXANDER
210 mm

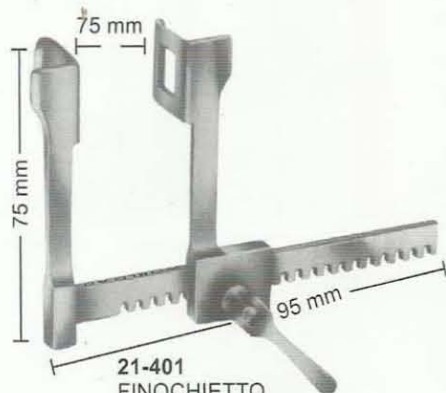

21-401
FINOCHIETTO
Blades
18X21 mm

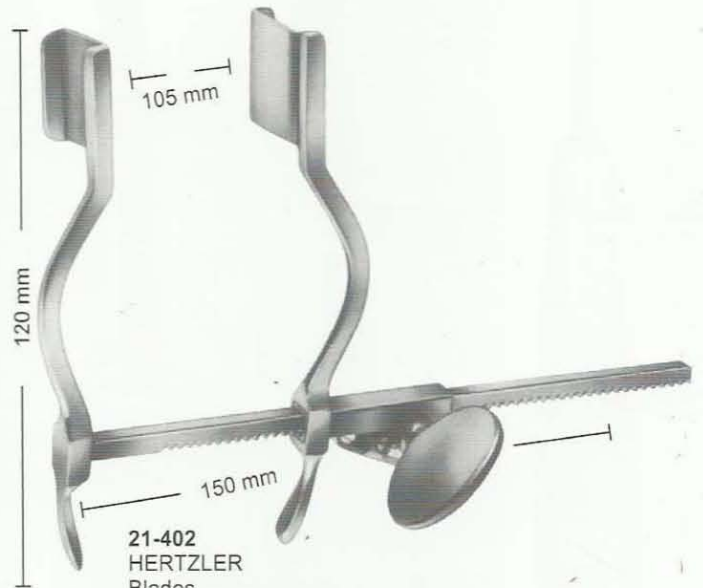

21-402
HERTZLER
Blades
20X25 mm

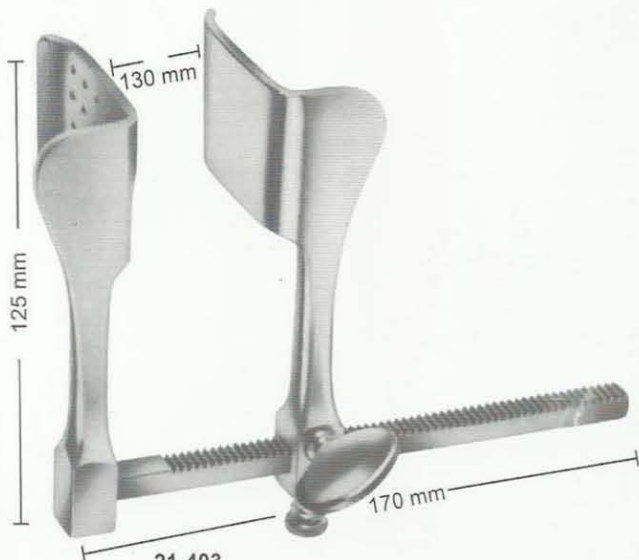

21-403
TUFFIER
Blades
43X53 mm

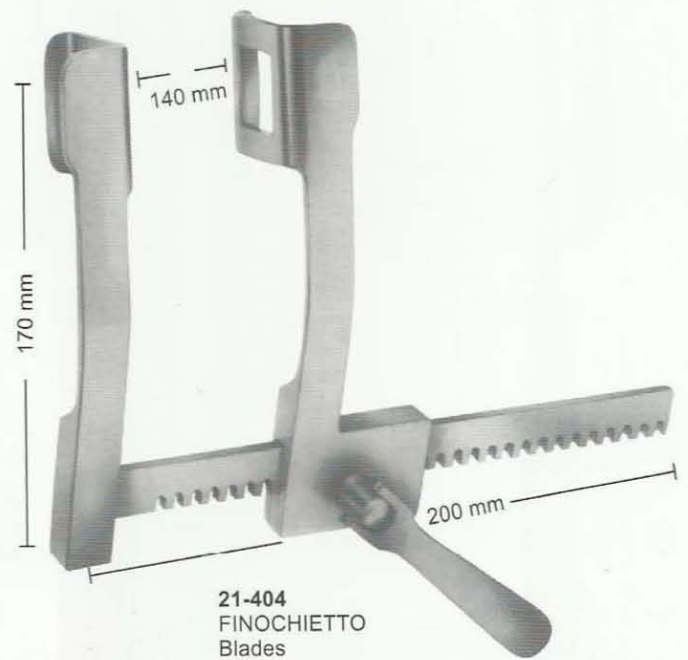

21-404
FINOCHIETTO
Blades
36X45 mm

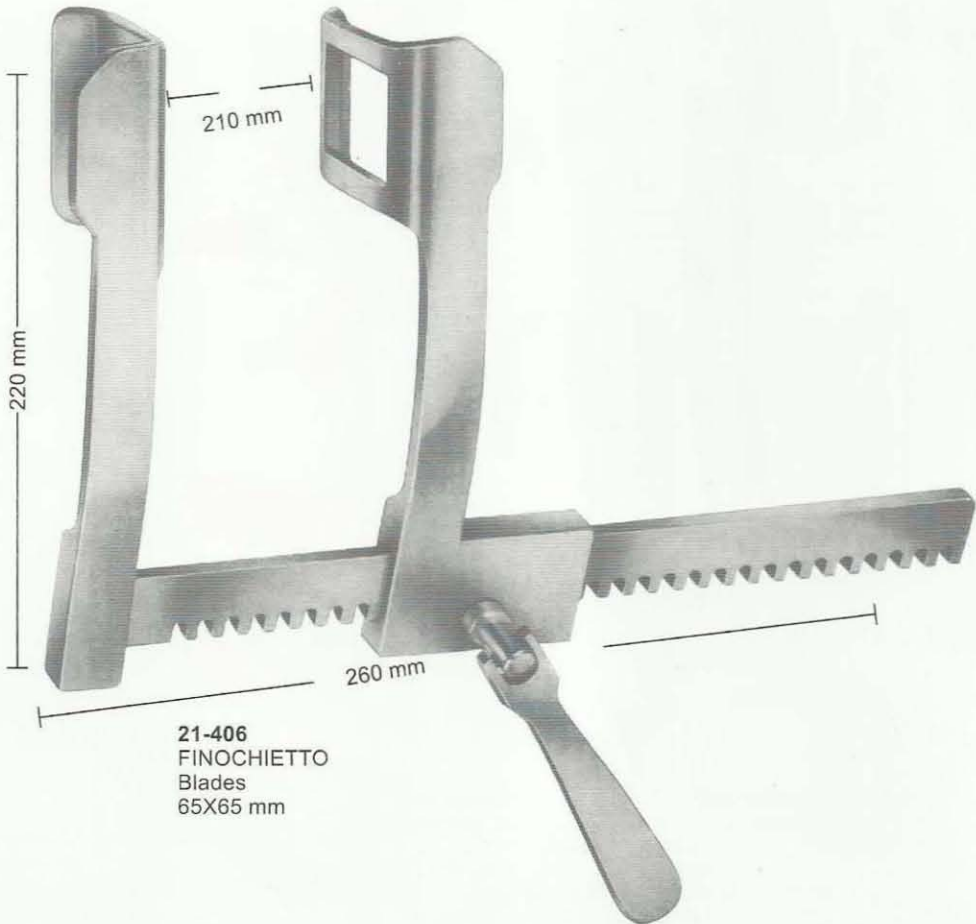
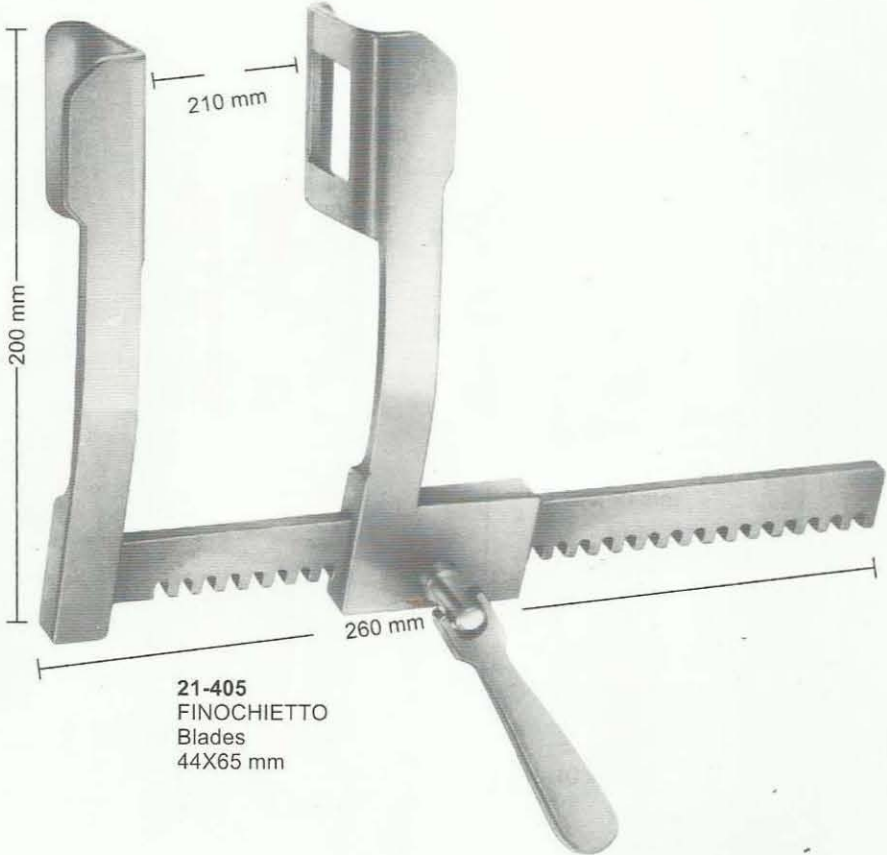

21-408
Blades
30x80 mm



21-409
Blades
40x67 mm



21-410
Blades
80x67 mm



21-411
Blade, Only, for preparation
of a. Mammaria, 25.5x80mm

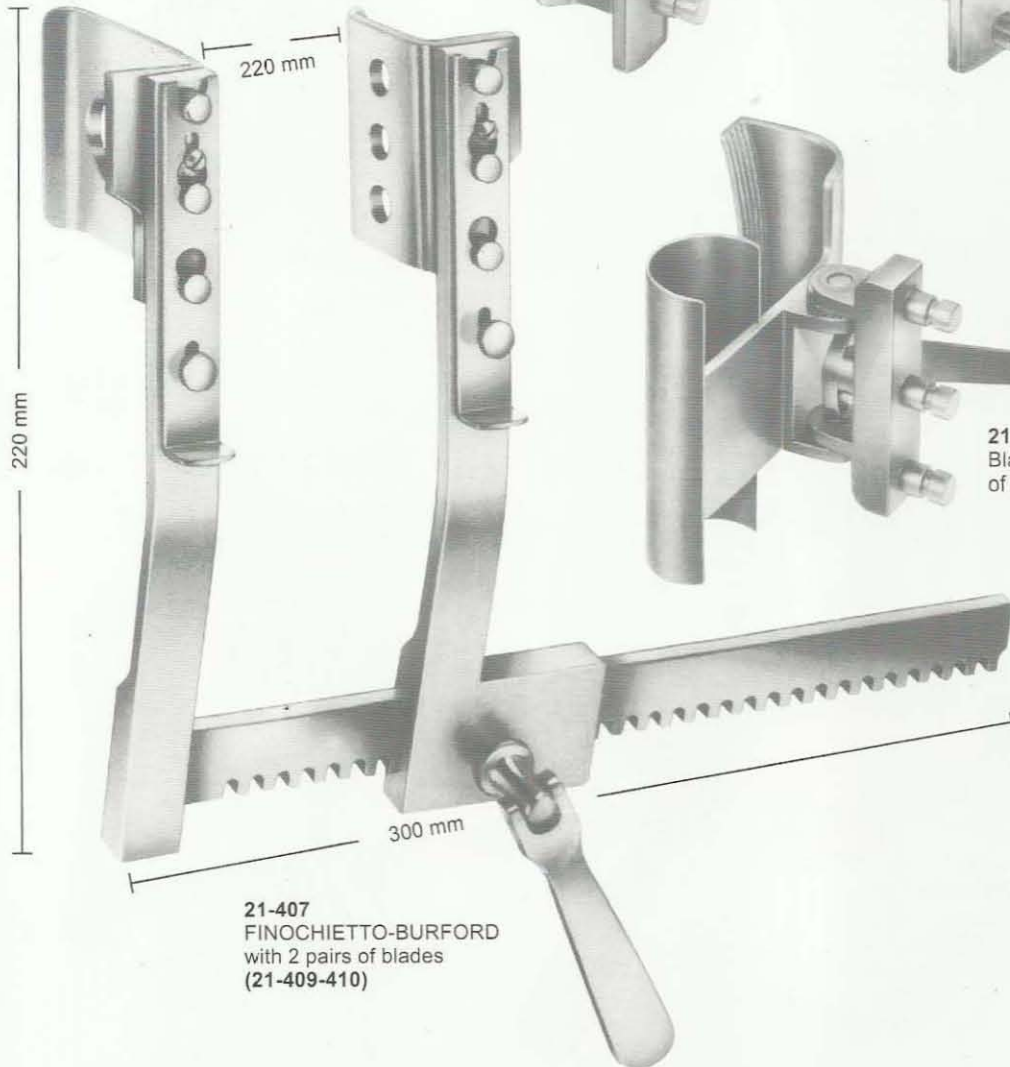

21-407
FINOCHIETTO-BURFORD
with 2 pairs of blades
(21-409-410)

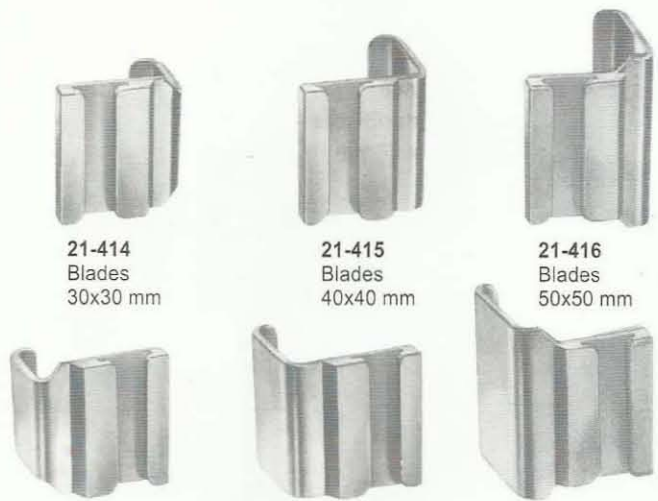
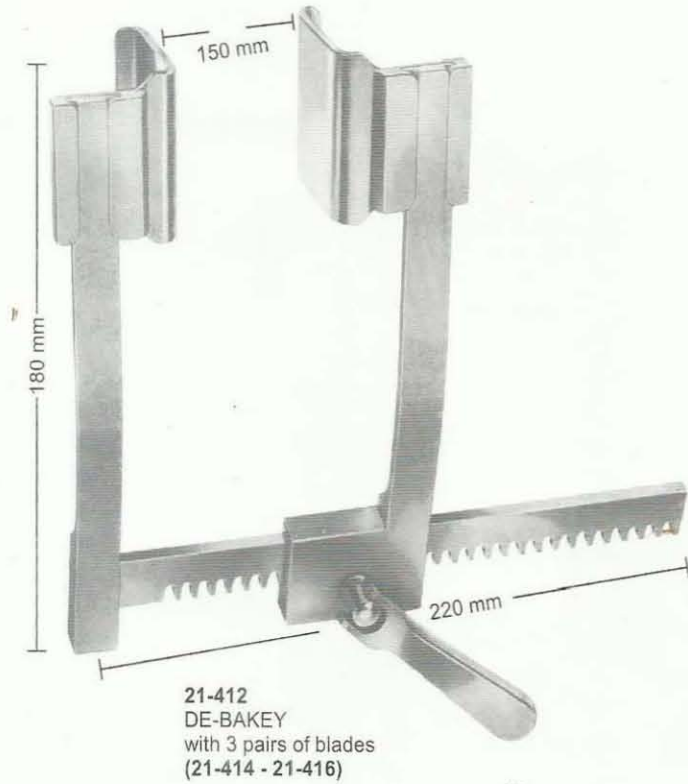

Components for 21-412
 Spreader only Blades only
 21-413 21-414 30x30mm
 21-415 40x40mm
 21-416 50x50mm
 The Blades are delivered in Pairs.

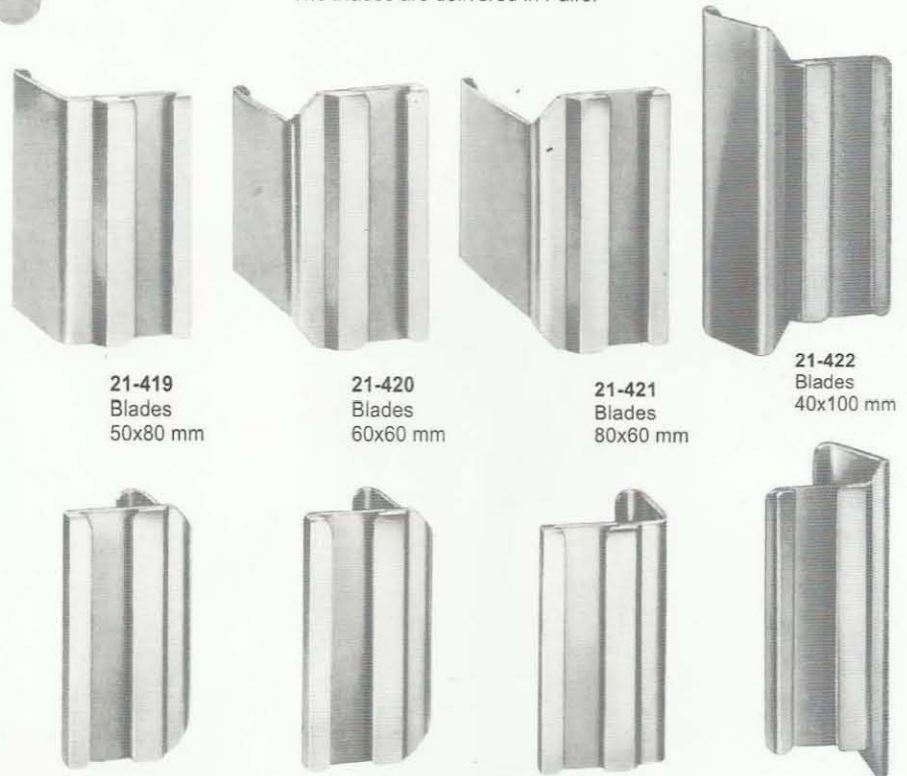
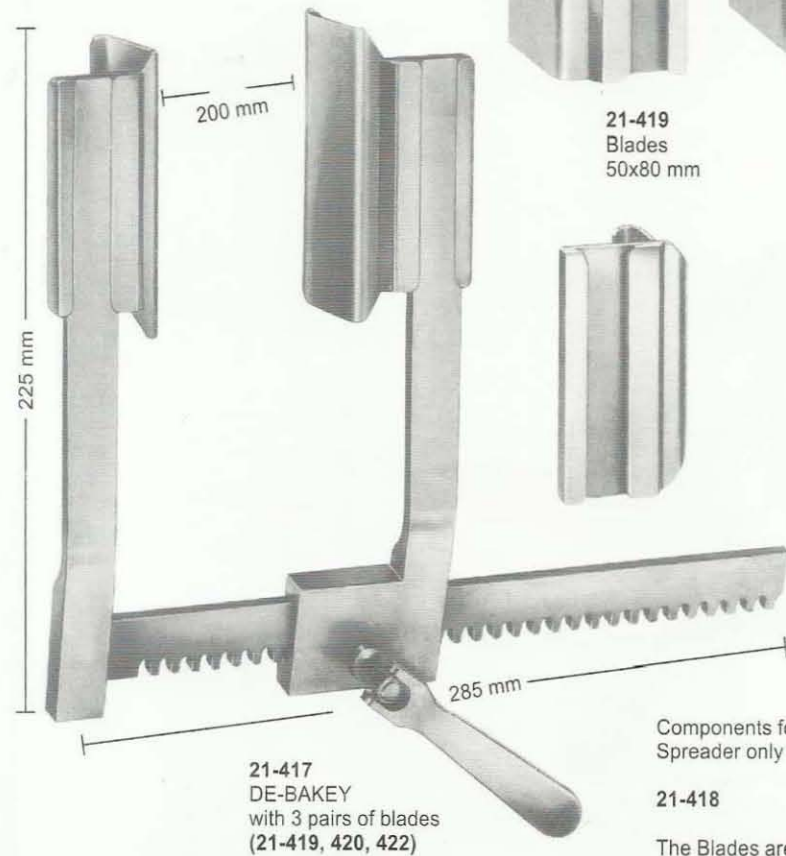

Components for 21-417
 Spreader only Blades only
 21-418 21-419 50x80mm
 21-420 60x60mm
 21-422 40x100mm
 The Blades are delivered in Pairs.



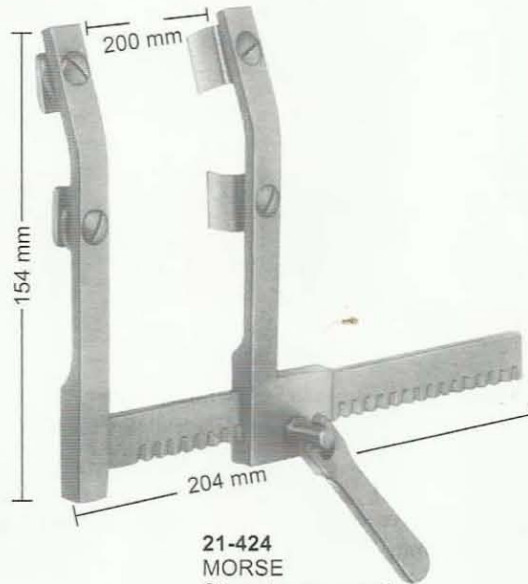

21-424
MORSE
Sternotomy spreader
for children, with moveable
double, blades each blade
12x20 mm

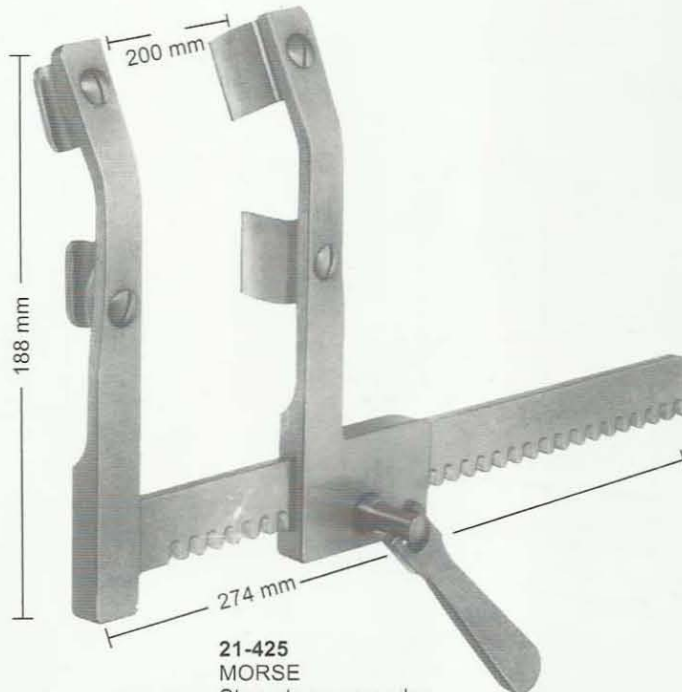

21-425
MORSE
Sternotomy spreader
for adults, with moveable
double, blades each blade
19x19 mm

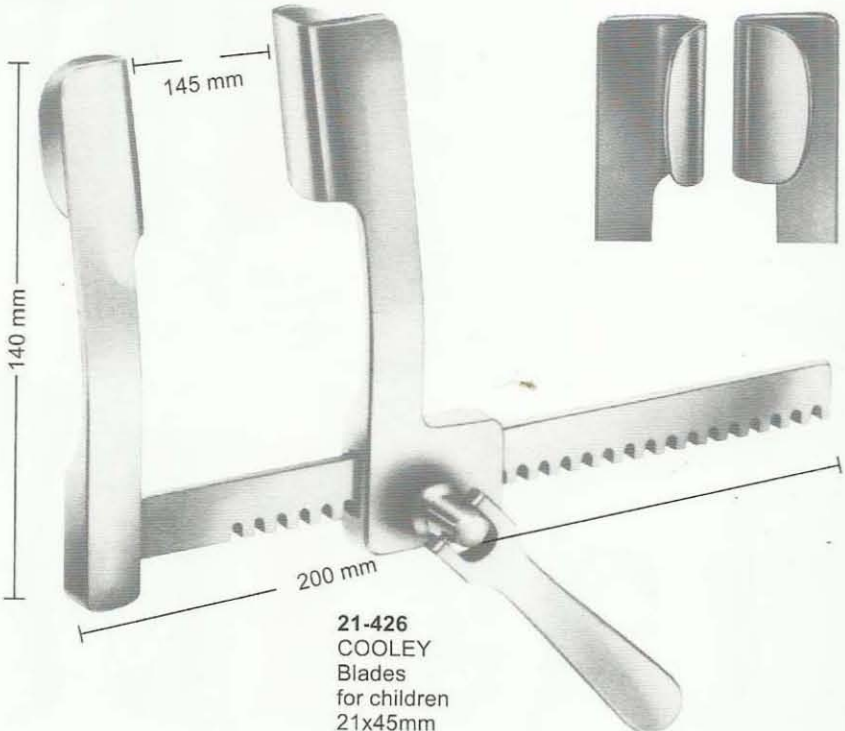

21-426
COOLEY
Blades
for children
21x45mm

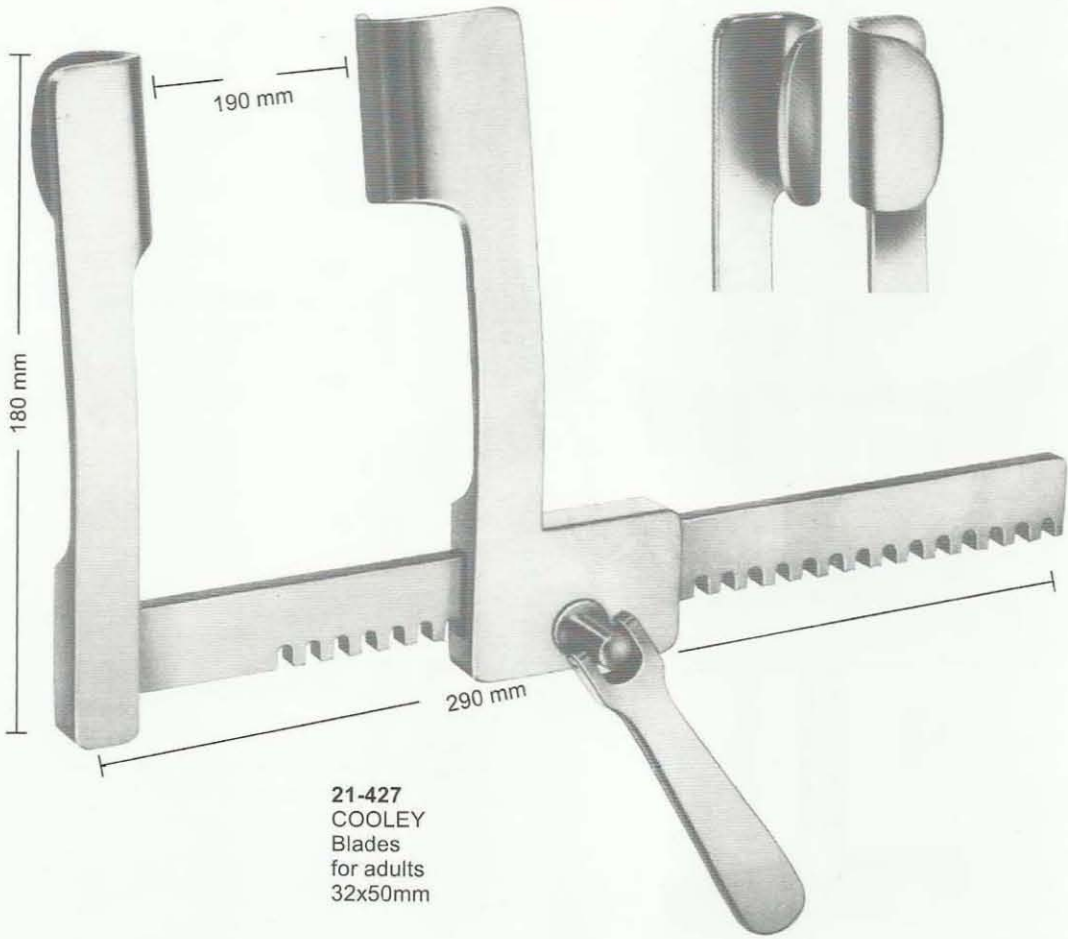

21-427
COOLEY
Blades
for adults
32x50mm

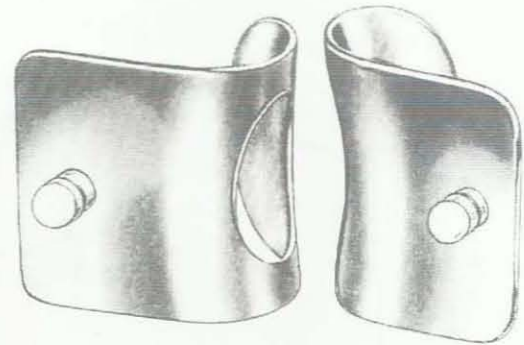
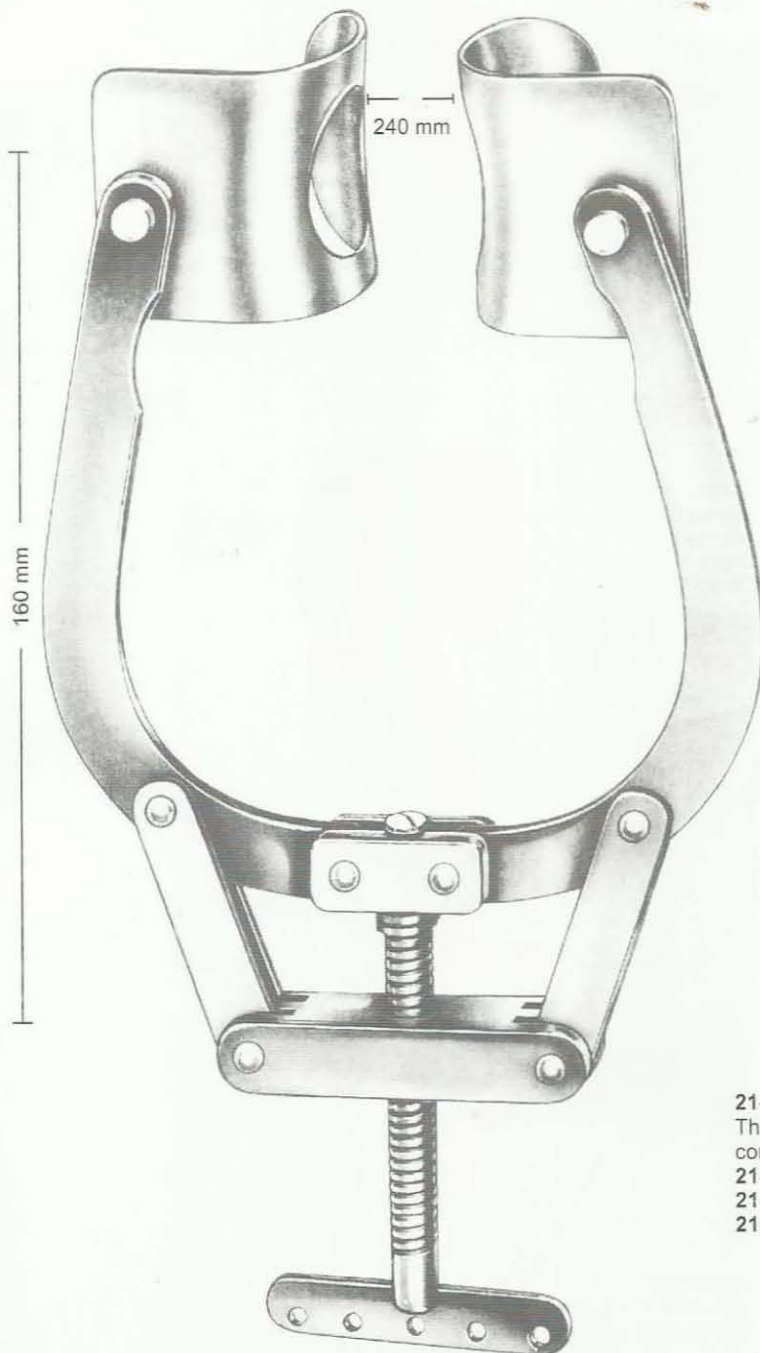

21-429
Blades
48 x 68 mm
Fig. 1

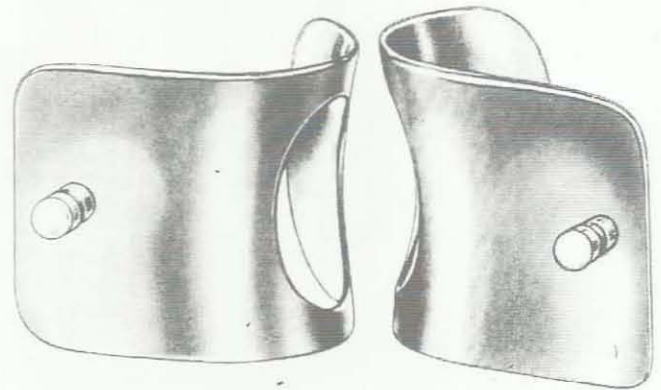

21-430
Blades
70 x 75 mm
Fig. 2

Blades with Ball Snap System
Delivery: in Pairs

- 21-428**
Thoracic Retractor (Mercedes-Retractor)
complete consisting of:
21-428 A Retractor only
21-430 1 Pair of blades 42x65 mm
21-429 1 Pair of blades 75x75 mm

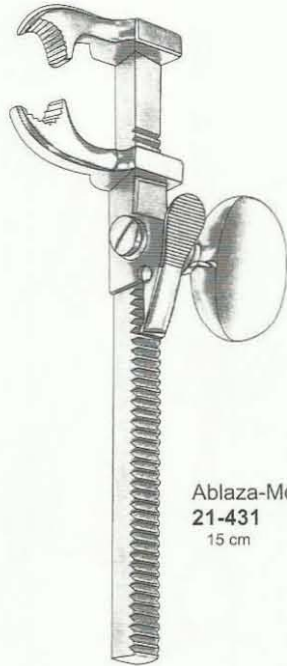

Ablaza-Morse
21-431
15 cm



Lemmon
21-431A
14 cm
21-431B
18 cm
Sternum-approximator
For adults



Sellors
21-432
20 cm

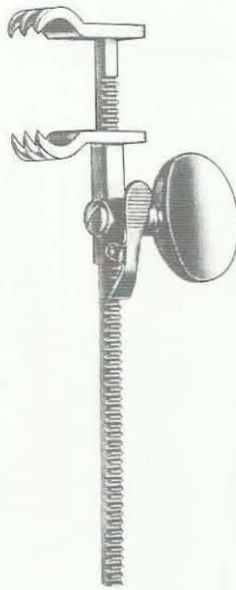

Bailey-Baby
21-433 / 6"

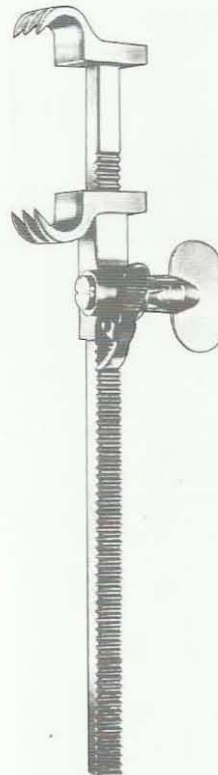

Bailey
21-434
20 cm
Short claws

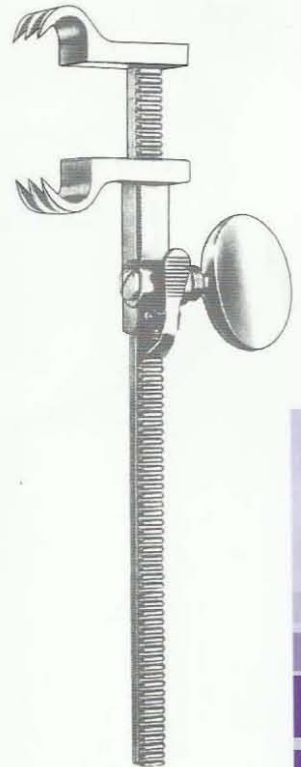

Bailey-Gibbon
21-434A
20 cm
Long claws



21-435
0.3 mm Ø

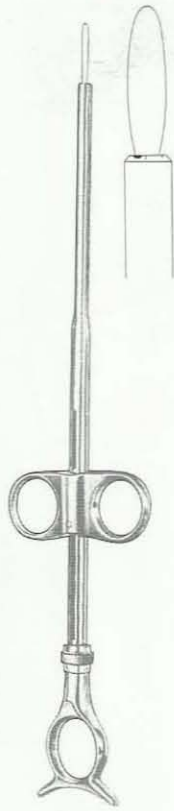

Eves
21-435A
28 cm



Eves
21-435B
28 cm

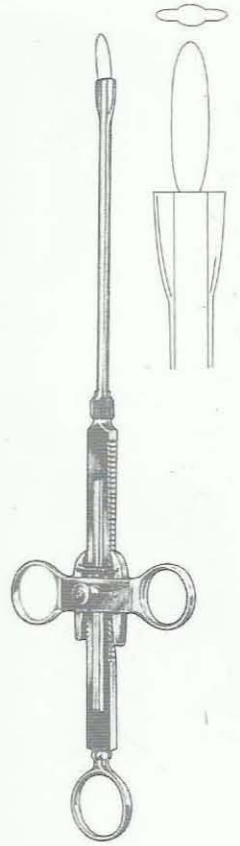

Bruenings
21-435C
28 cm

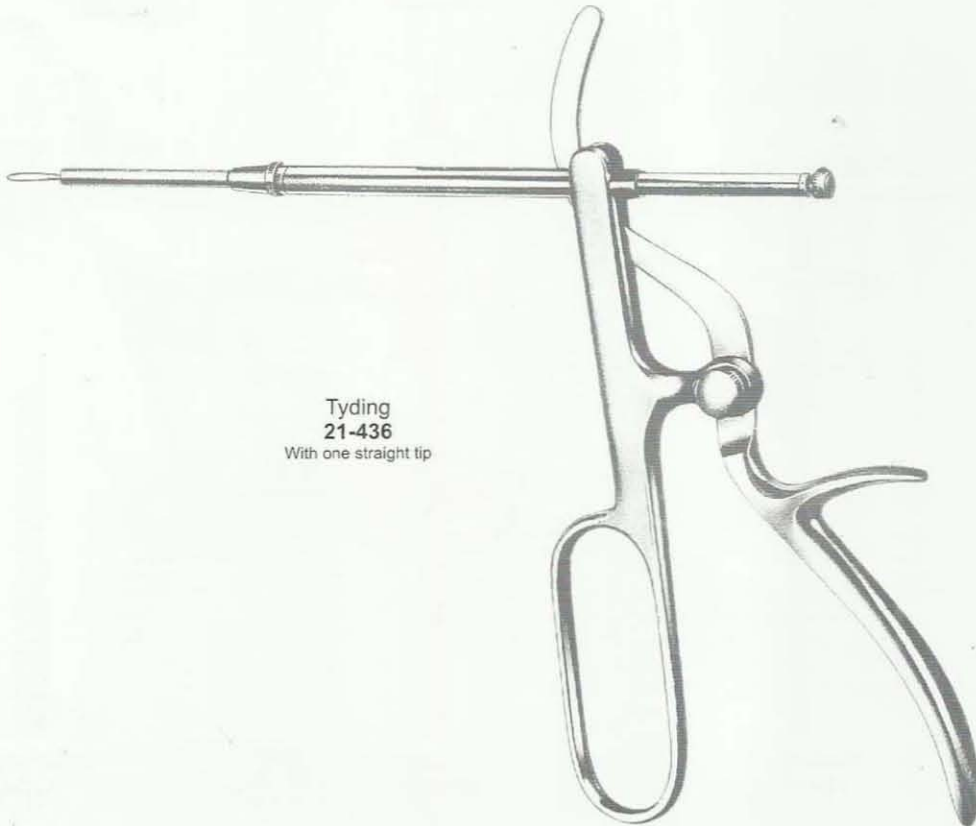

Tyding
21-436
With one straight tip

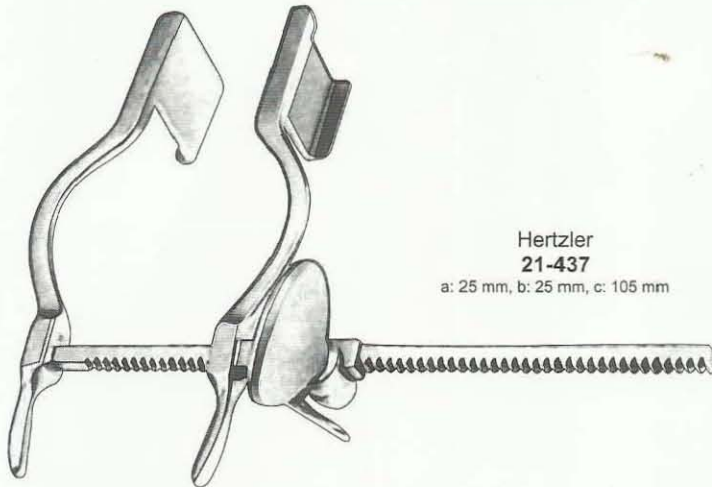
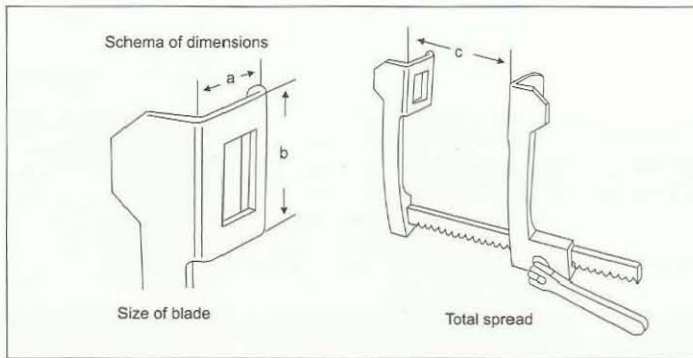

Hertzler
21-437
a: 25 mm, b: 25 mm, c: 105 mm

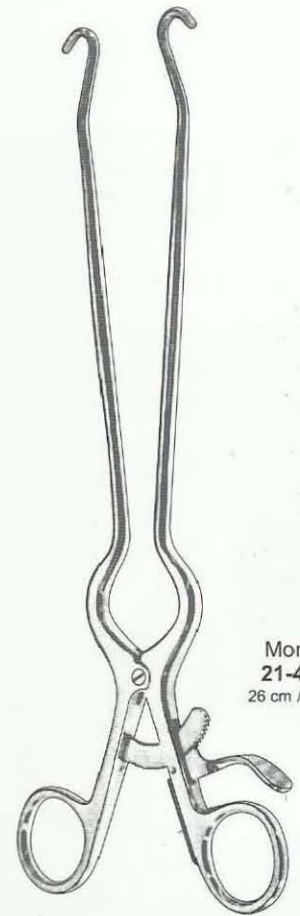

Morris
21-438
26 cm / 10 1/4"

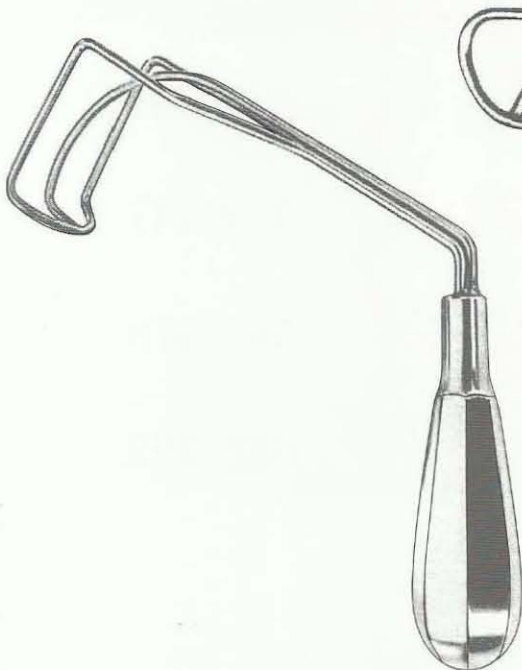

Cooley
21-439

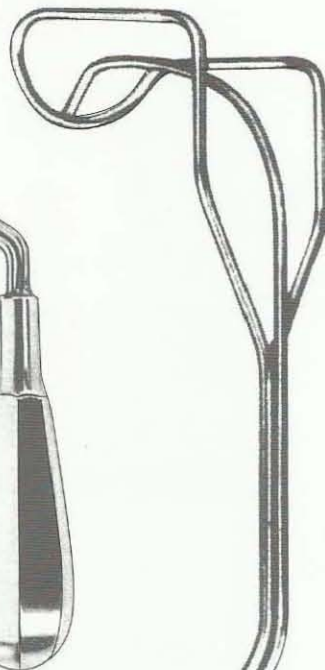

Cooley
21-440
24.5 cm / 9 3/4"
Right

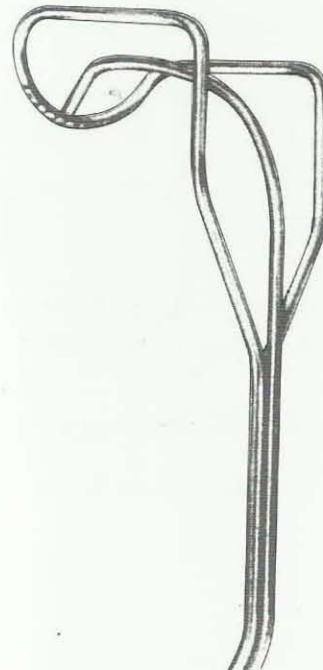

Cooley
21-440A
24.5 cm / 9 3/4"
Right, slightly serrated

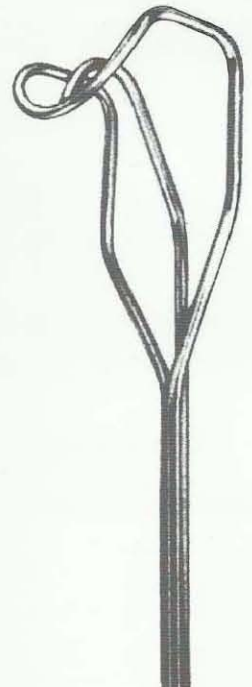

Cooley
21-440B
25.5 cm / 10"
Left

Orthopaedic Instruments

.....310 To 392

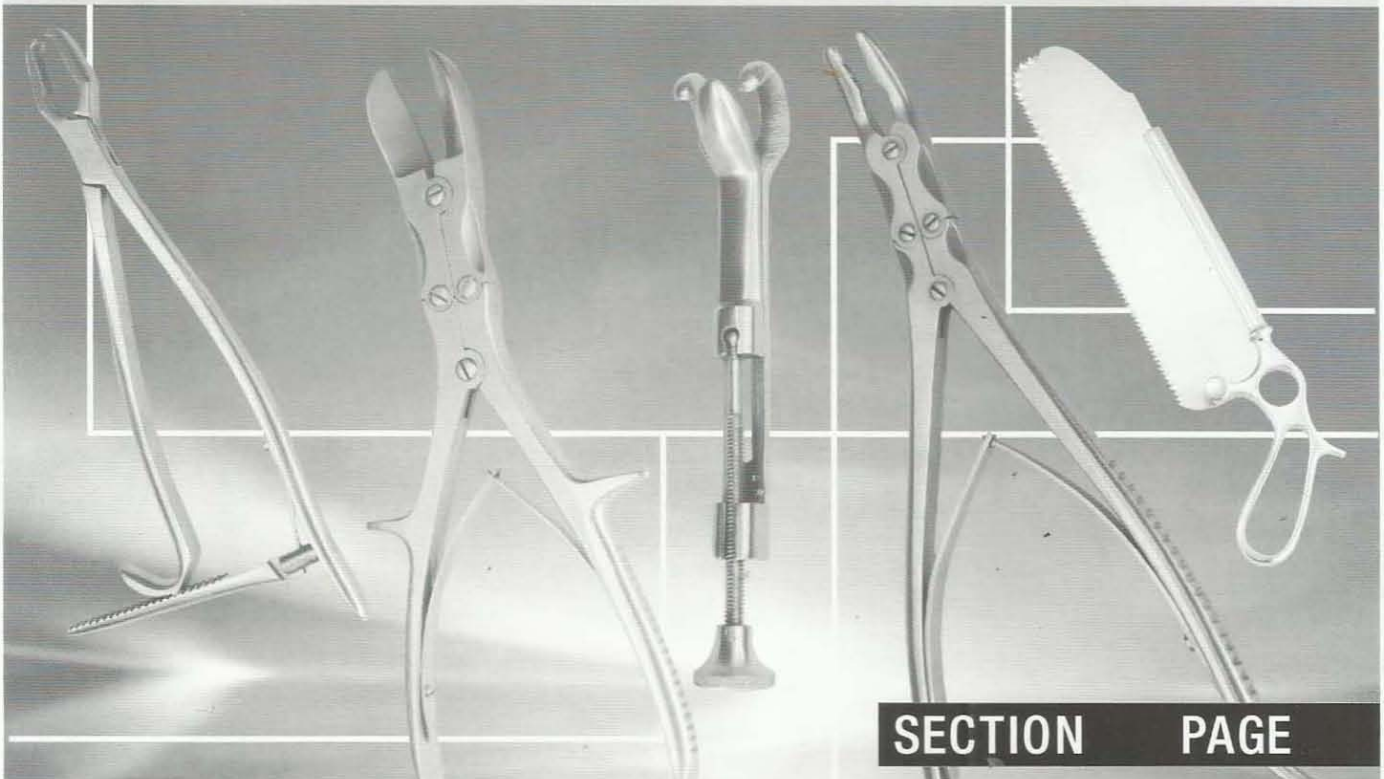

SECTION PAGE

Bone Punches And Rongeurs

22 310-318

Amputation, Elevators, Raspatories, Bone Levers
Bone Files And Curettes

23-24 319-347

Mallets, Tampers, Chisels, Gauges, Bone Holding, Rongeurs
& Cutting Forceps, Meniscus Instruments

25-26 348-379

Wire Extension, Finger Nail instruments

27 380-392

Angled positions for punches

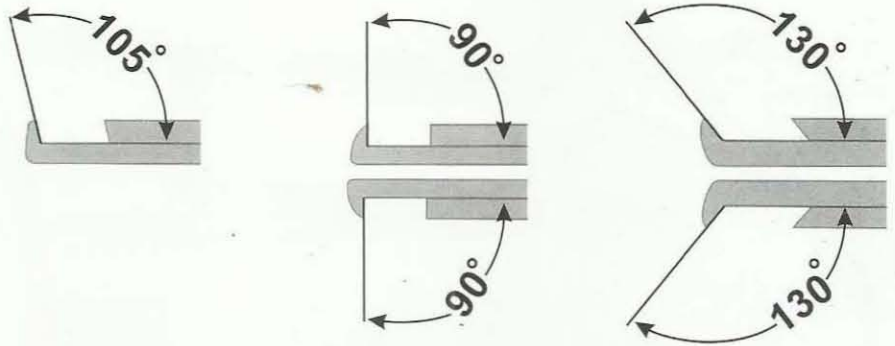

90° upwards cutting

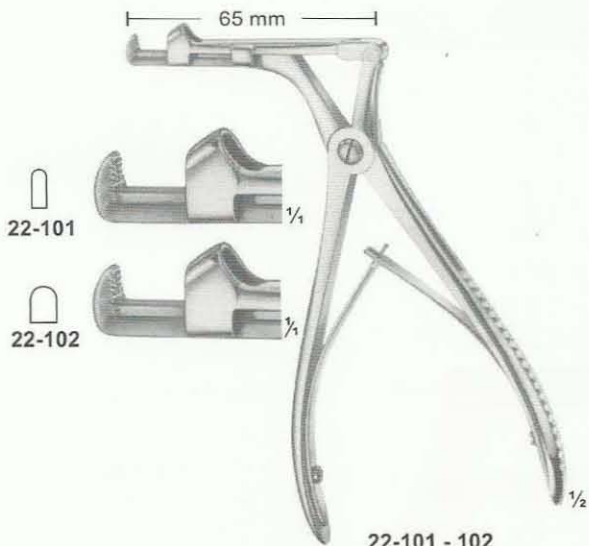

22-101 - 102
CITELLI
22-101 2mm
22-102 3.5mm

90° upwards cutting

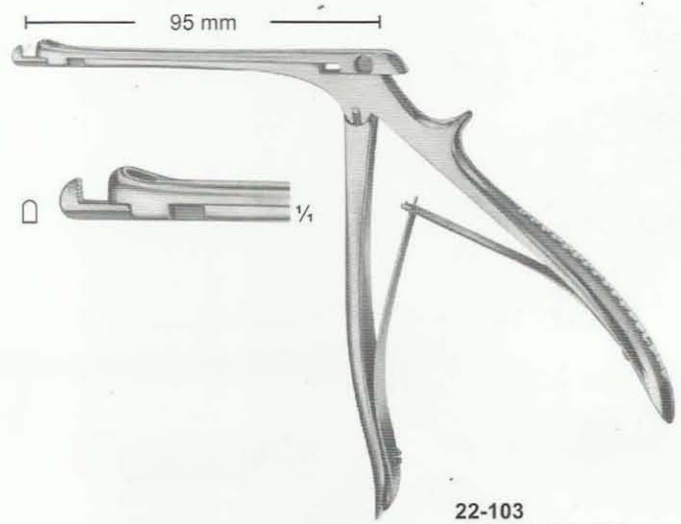

22-103
CITELLI-BEYER
1,8 mm

90° upwards cutting

85 mm

22-104
4 mm



1/4

22-105
5 mm



1/4



1/2

22-104 - 105
KERRISON

90° upwards cutting

140 mm

22-106
3,3 mm



1/4

22-107
4,0 mm



1/4

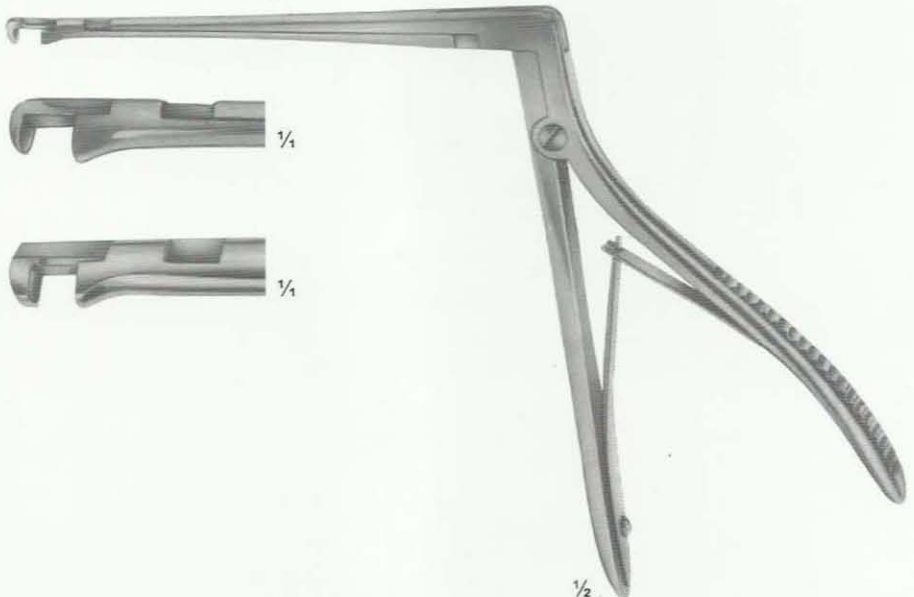

1/2

22-106 - 107
HAJEK-KOFLER

130° upwards cutting

KERRISON-JACOBY

22-108
1 mm □

FERRIS-SMITH-KERRISON

22-109
2 mm □

22-110
3 mm □

22-111
4 mm □

22-112
5 mm □

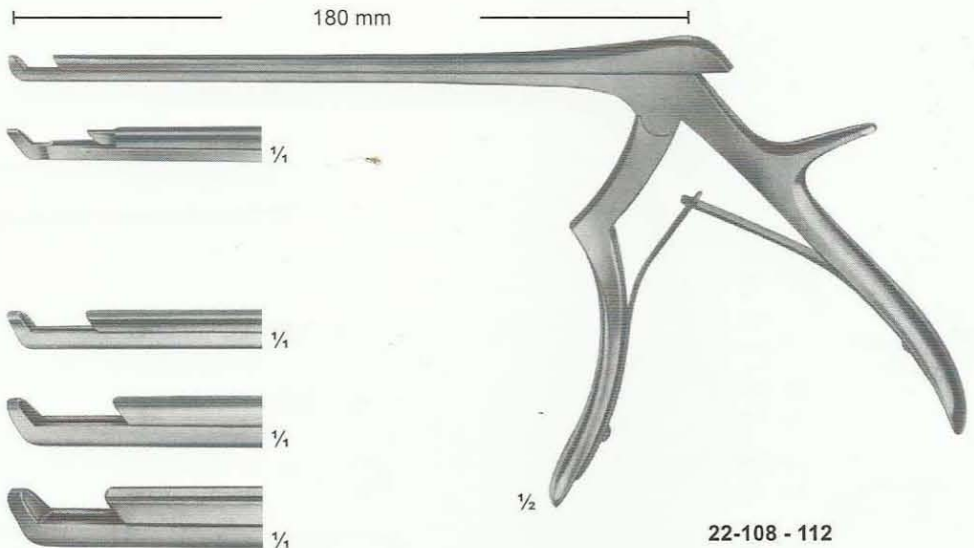

90° upwards cutting

KERRISON-JACOBY

22-113
1 mm □

22-114
2 mm □

FERRIS-SMITH-KERRISON

22-115
3 mm □

22-116
4 mm □

22-117
5 mm □

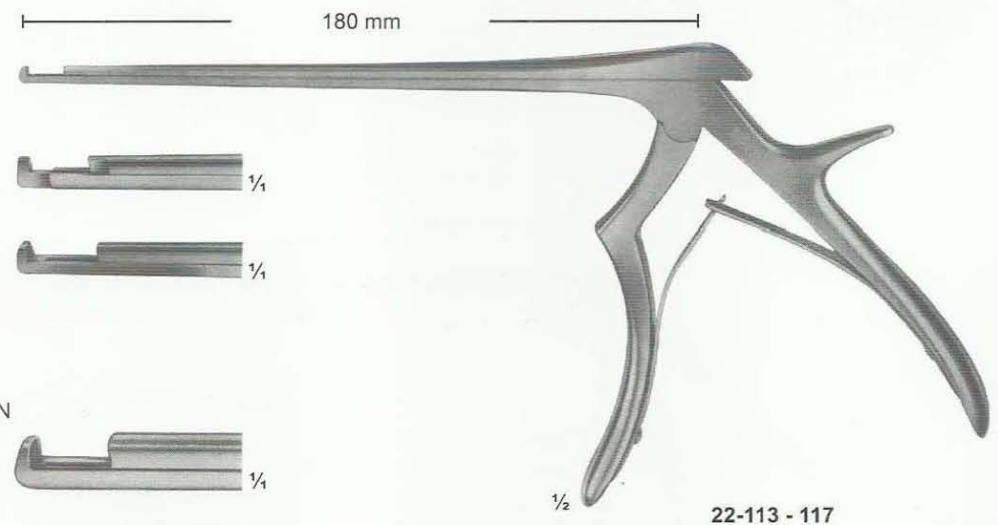

Rongeurs

Angled positions for rongeurs

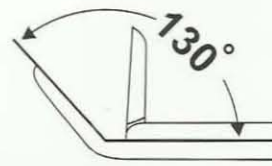
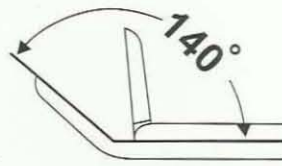
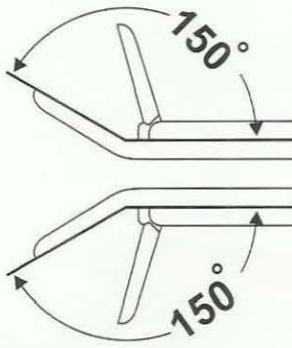

- 22-118
3,0 mm
- 22-119
3,6 mm
- 22-120
4,2 mm
- 22-121
4,8 mm
- 22-122
5,8 mm

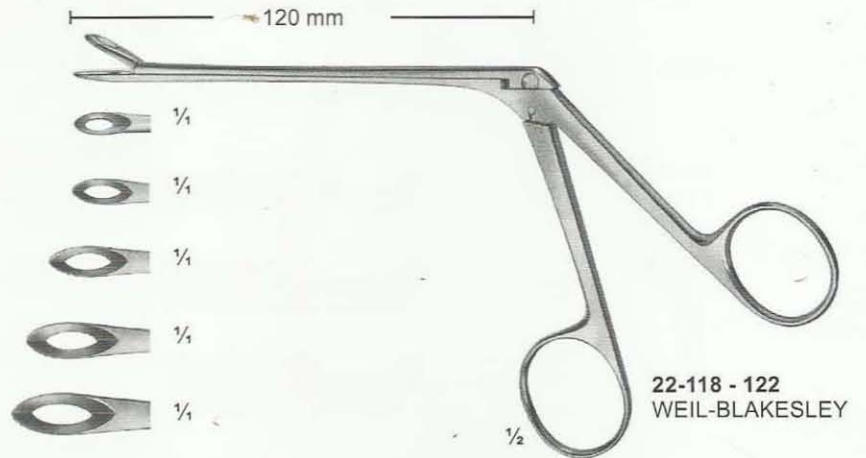

130°

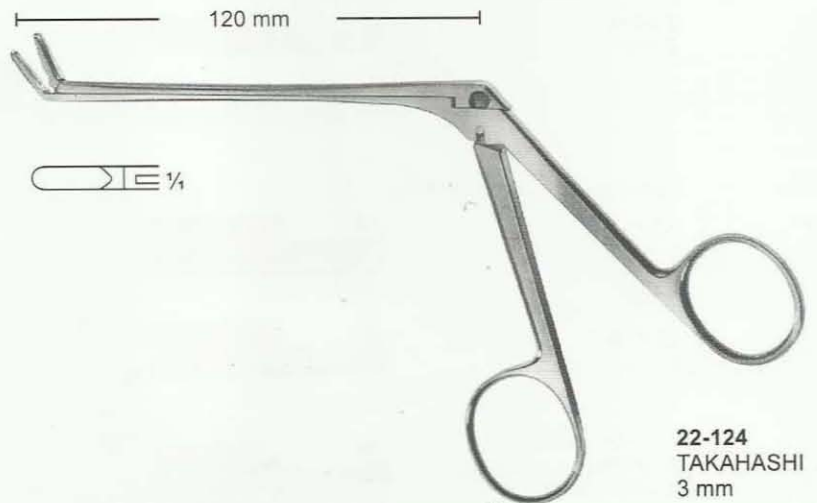

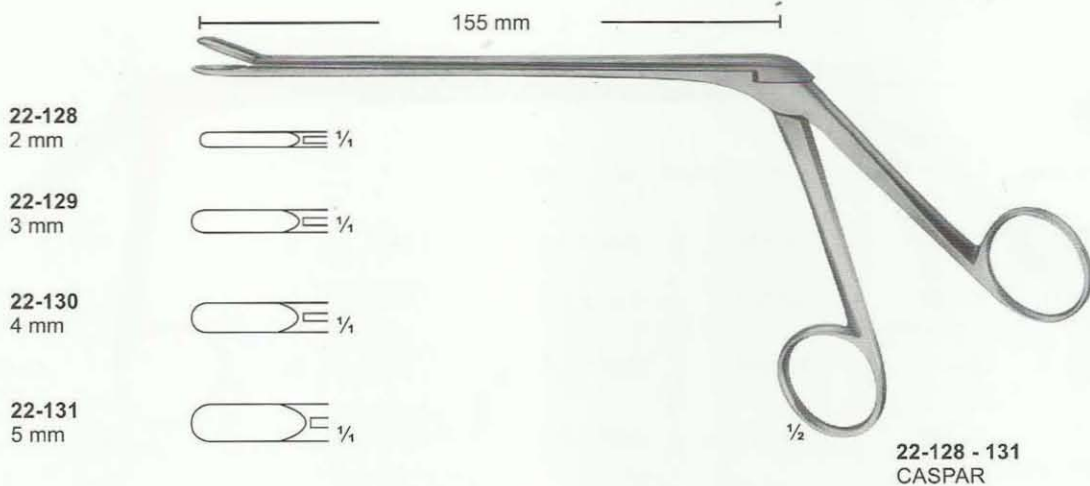
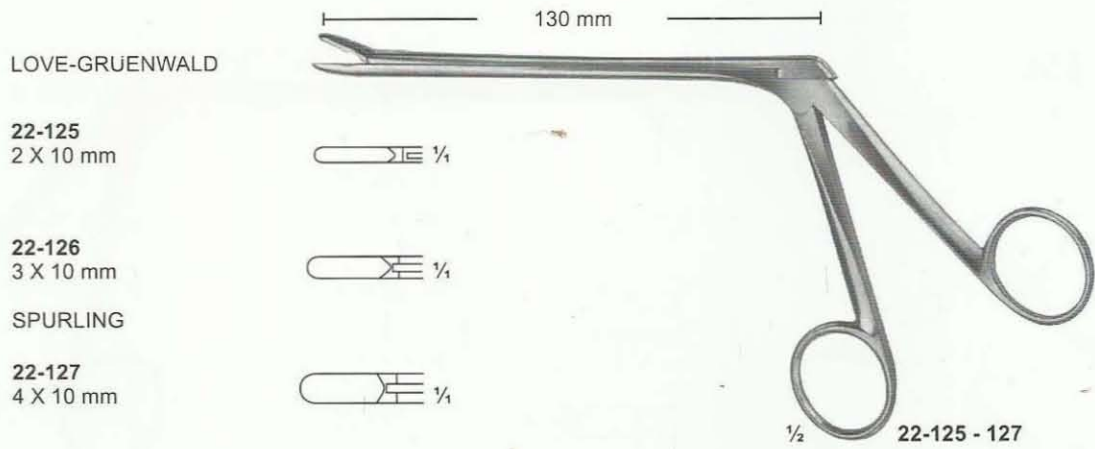

150°

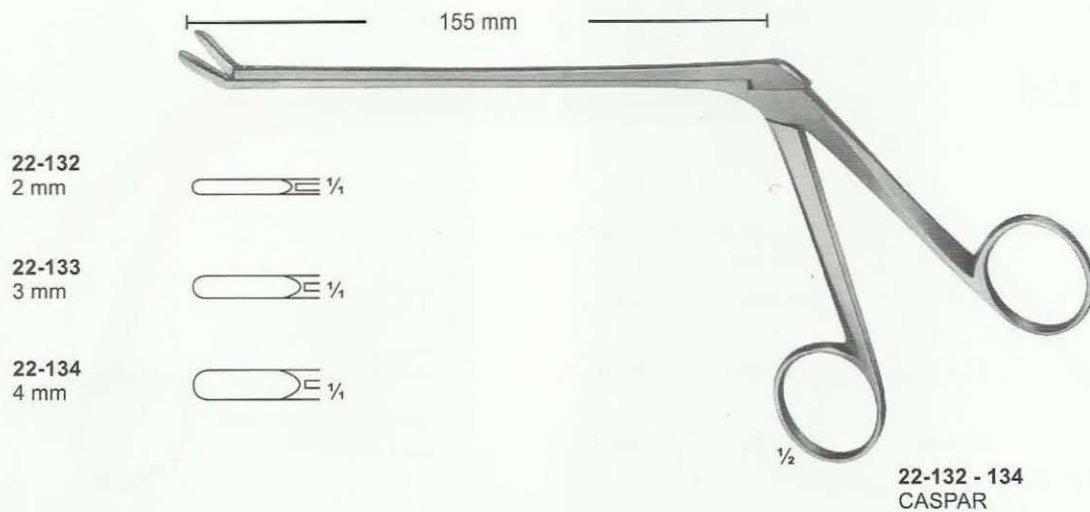

150°

Lower part of jaws movable

22-135
2 mm

22-136
3 mm

22-137
4 mm

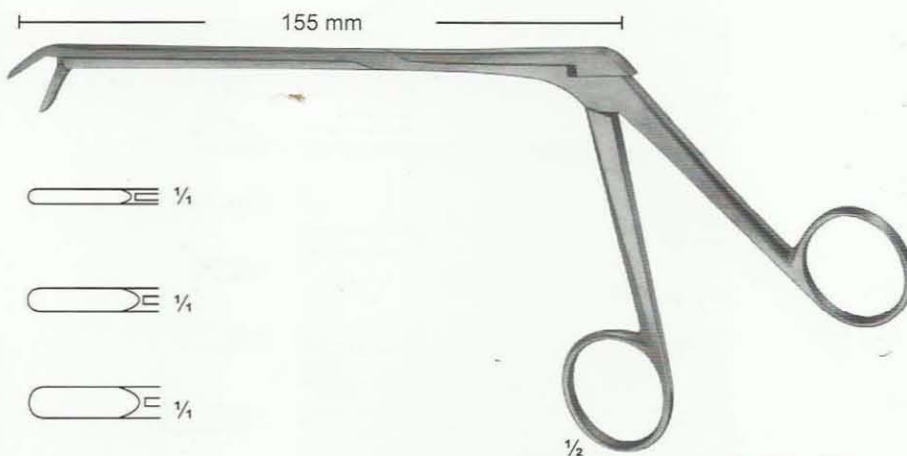

22-135 - 137
CASPAR

Length of shaft 140 mm	Length of shaft 160 mm	Length of shaft 185 mm	size of jaws
---------------------------	---------------------------	---------------------------	--------------

22-138

22-143

22-148

2 X12 mm

1/4

22-139

22-144

22-149

3 X12 mm

1/4

22-140

22-145

22-150

4 X14 mm

1/4

22-141

22-146

22-151

5 X14 mm

1/4

22-142

22-147

22-152

6 X16 mm

1/4

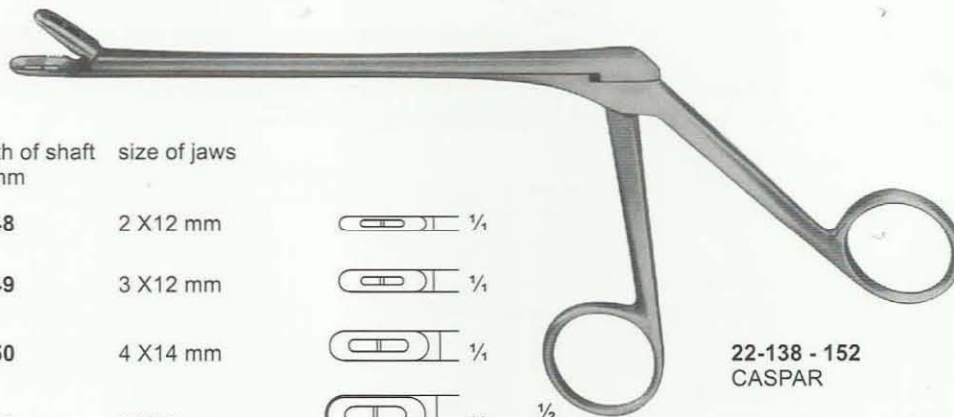

22-138 - 152
CASPAR

150°

Length of shaft 140 mm	Length of shaft 160 mm	Length of shaft 185 mm	size of jaws
---------------------------	---------------------------	---------------------------	--------------

22-153

22-156

22-159

3 X12 mm

1/4

22-154

22-157

22-160

4 X14 mm

1/4

22-155

22-158

22-161

5 X14 mm

1/4

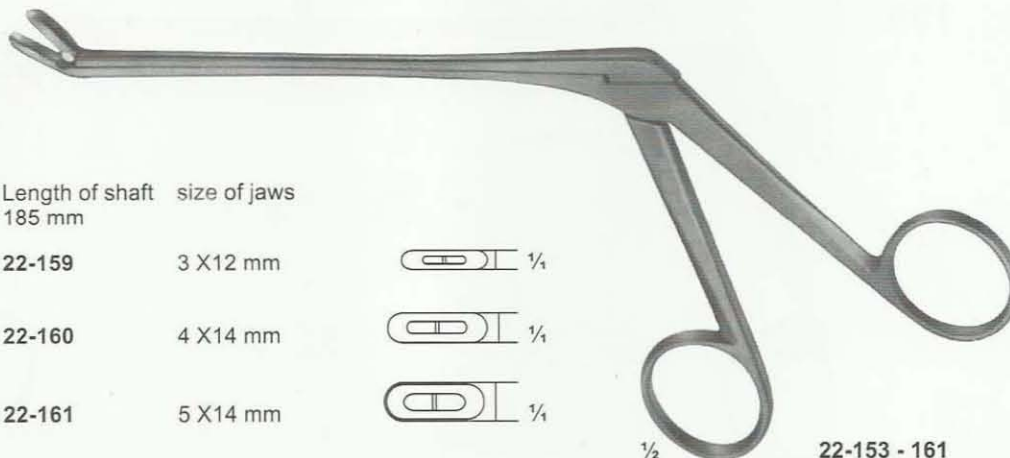

22-153 - 161
CASPAR

150°

Lower part of jaw movable

Length of shaft 140 mm	Length of shaft 160 mm	Length of shaft 185 mm	size of jaws
22-162	22-164	22-166	3 X 12 mm
22-163	22-165	22-167	4 X 14 mm

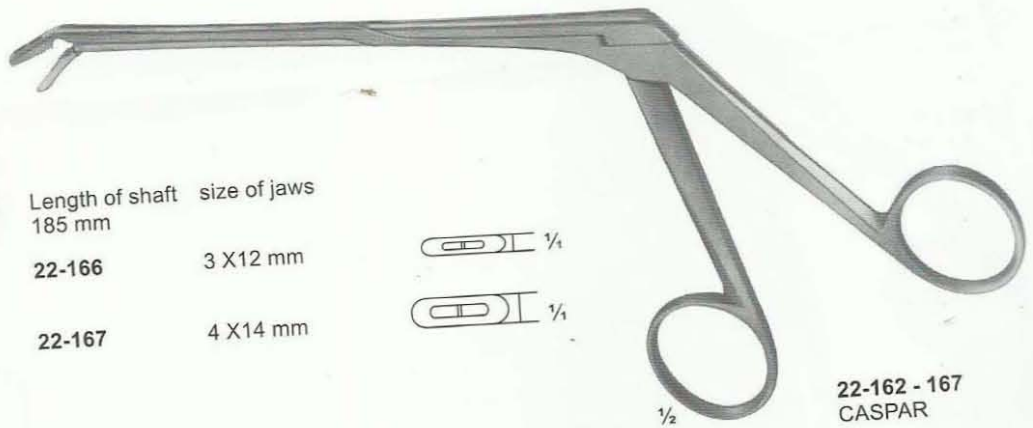

22-162 - 167
CASPAR

180 mm

22-168
2 X 10 mm
CUSHING

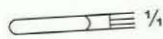

22-169
3 X 10 mm
LOVE-GRUENWALD

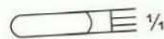

22-170
4 X 10 mm
SPURLING

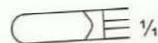

180 mm

150°

22-171
3 X 10 mm
LOVE-GRUENWALD



22-172
4 X 10 mm
SPURLING

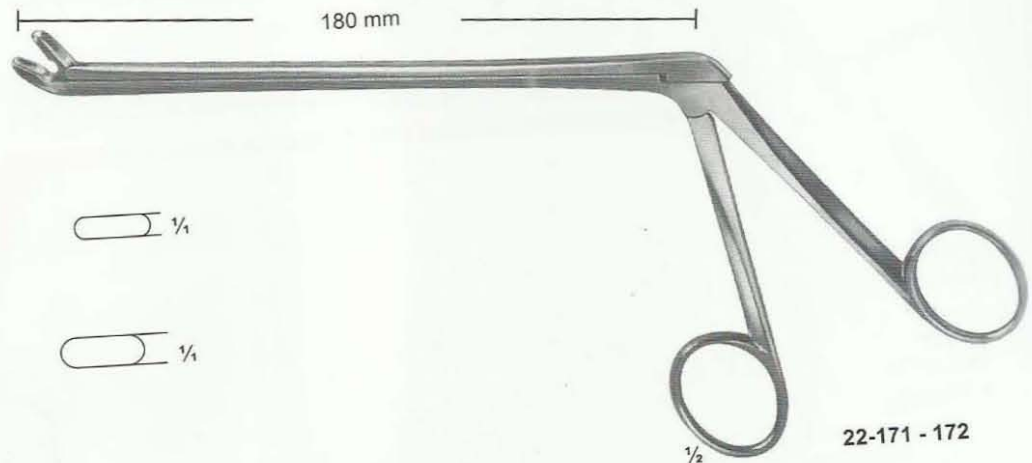

22-171 - 172

150°

Upper part of jaw
movable

22-173
3 X 10 mm
LOVE-GRUENWALD

22-174
4 X 10 mm
SPURLING

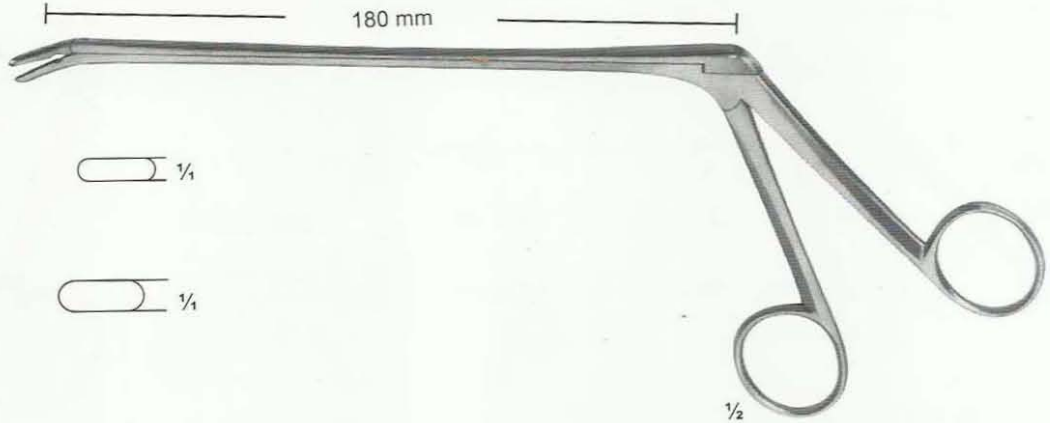

22-173 - 174



22-175
ø 7 mm

22-175
OLDBERG



18-176
YASARGIL
ø 2,2 mm

18-177
YASARGIL
ø 3,5 mm

22-176 - 177

145 mm

22-178
4 mm

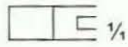

Osteophyte Rongeur

180 mm

22-179
4 mm

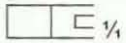

Osteophyte Rongeur

200 mm

22-180
5,5 mm



Very Heavy Pattern

1/2

22-178
CASPAR

22-179
CASPAR

1/2

22-180
WAGNER

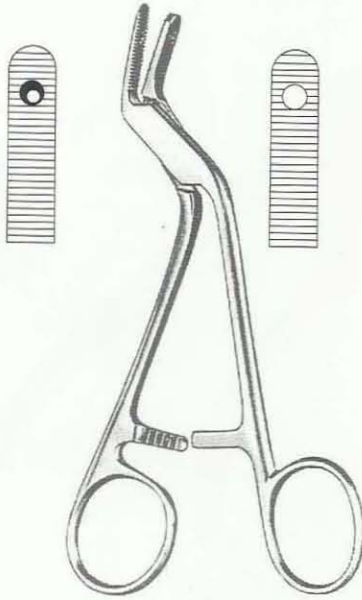

ADSON
23-101
15 cm
Drill guide



23-102
14 cm

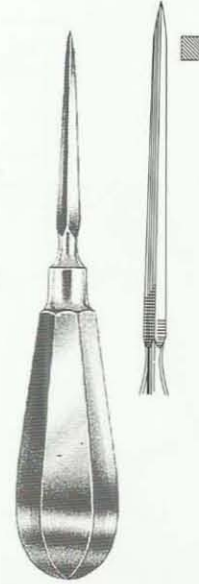

23-103
14 cm

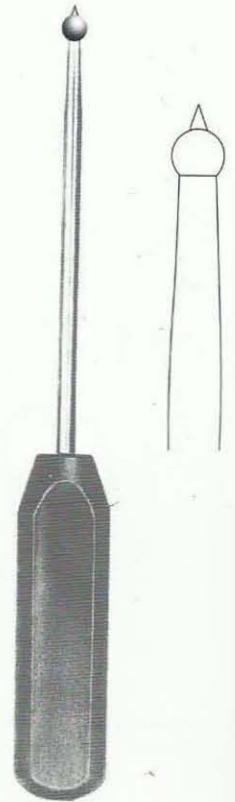

23-104
30 cm
Straight ball spike

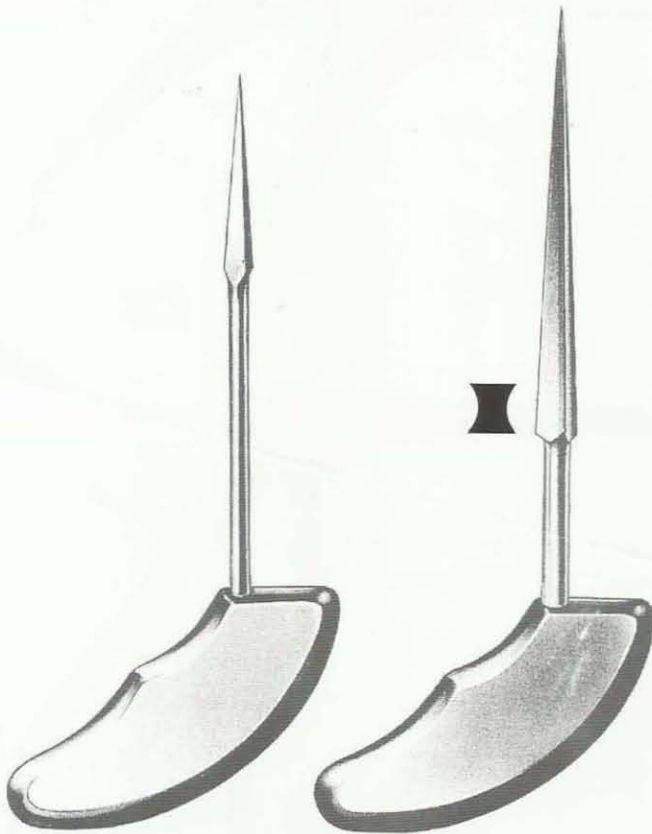

PERTHES
23-105
18 cm

PERTHES
23-105A
21 cm

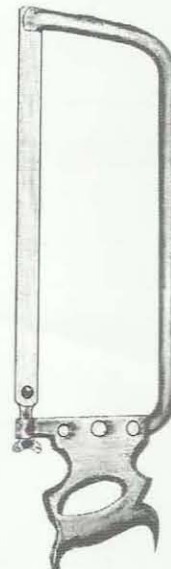

BUTCHER
23-105B
Blade 45 cm
Post mortem saw



23-105C
Blade 40 cm
Post mortem saw

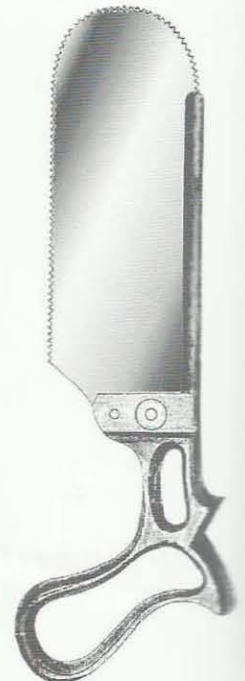

23-105D
30 cm
Blade 20 cm
Post mortem saw

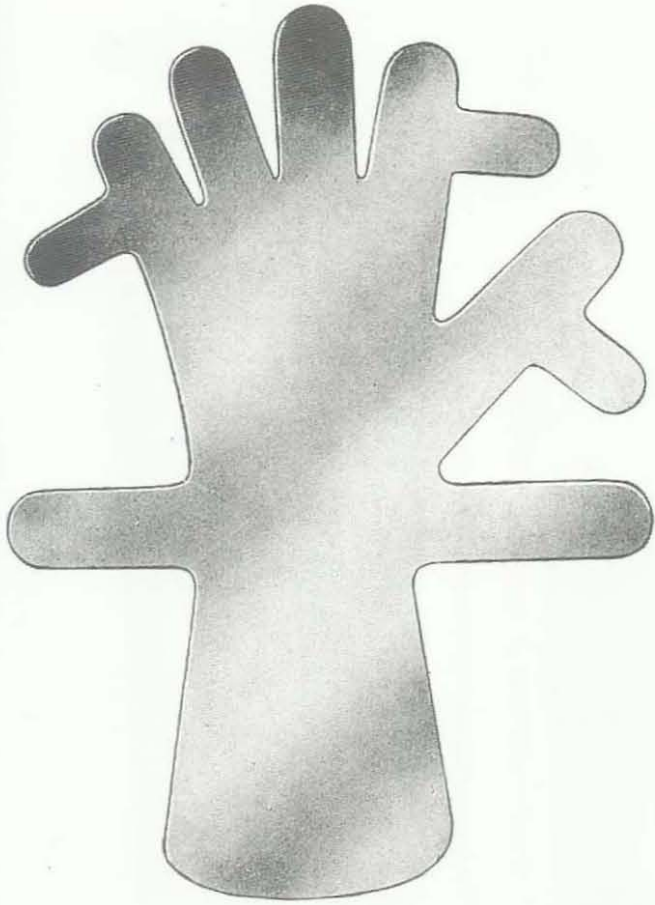

23-105A For children
23-105B For adults

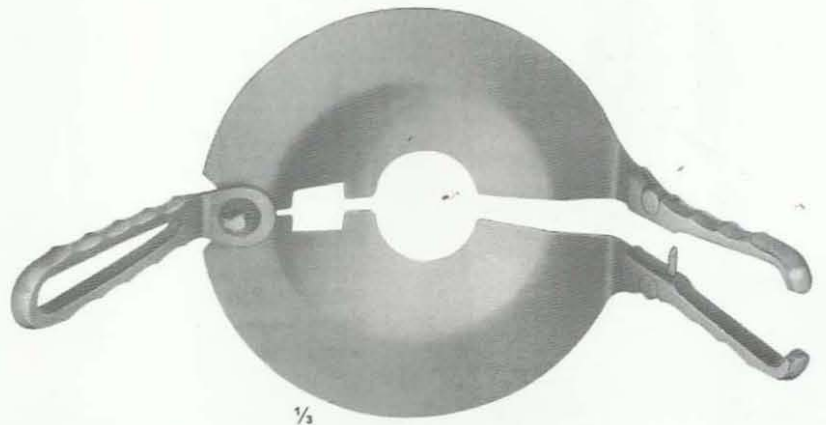

23-106
PERCY
removeable handles

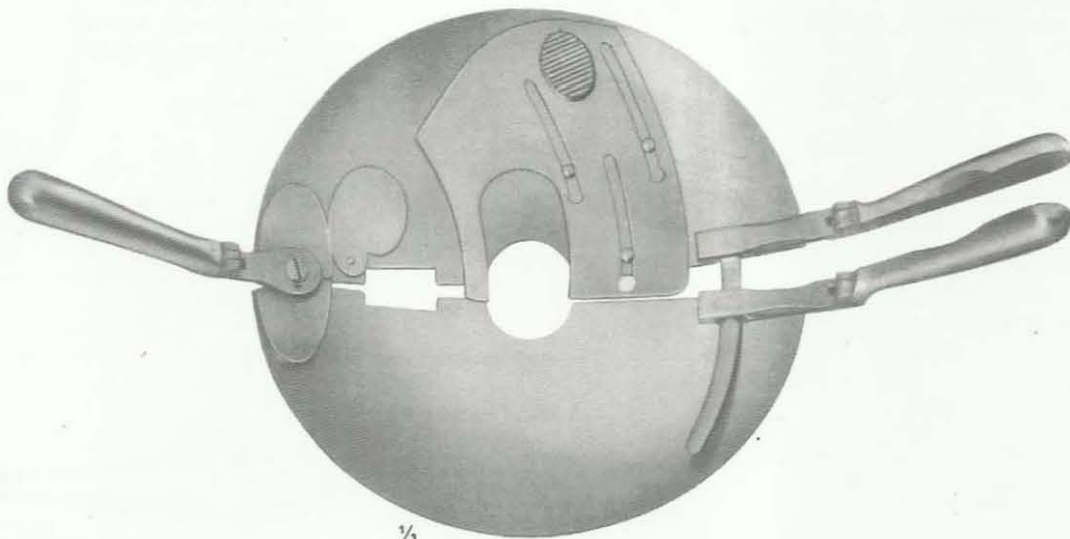

23-107
PERCY
reversible handles

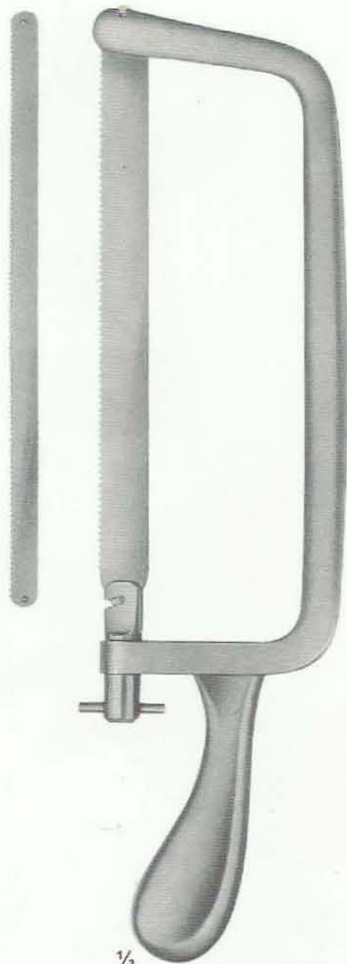

1/3

23-108
CHARRIERE
 Length of blade
 215 mm
 complete with one saw
 blade each(**23-109** and **23-110**)
 350 mm

Spare saw blades, carbon steel
23-109 12 mm
23-110 20 mm

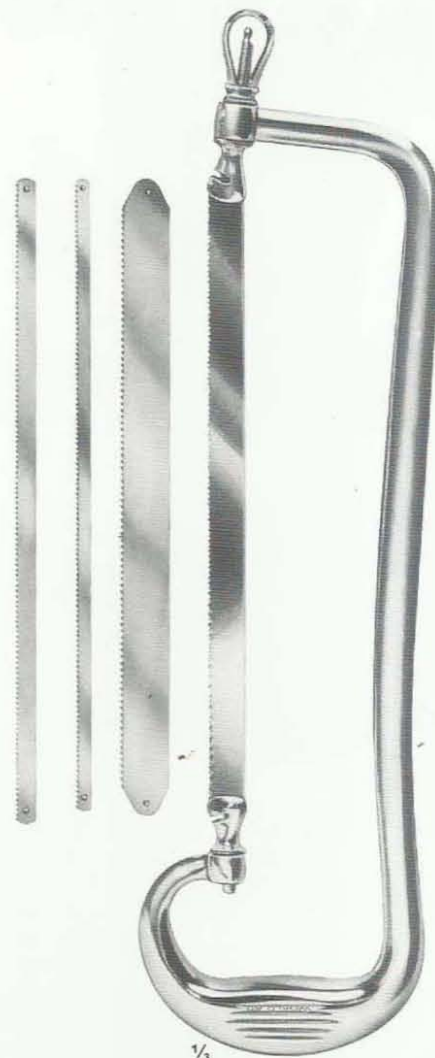

1/3

23-111
RUST
 Length of blade
 235 mm
 complete with one saw
 blade each(**23-113**, **23-114**
 and 2 saw blades **23-115**)
 390 mm
23-112 Bow only

Spare saw blades, carbon steel
23-113 6 mm
23-114 8 mm
23-115 12 mm
23-116 20 mm

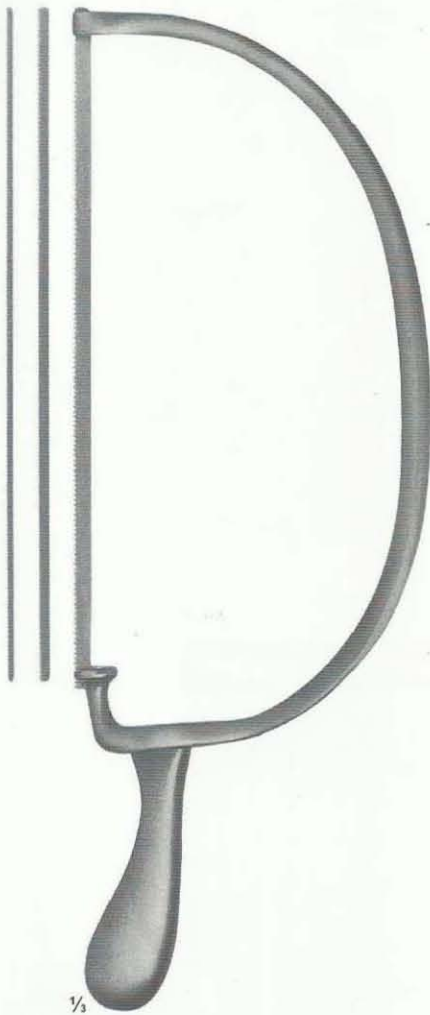

23-117
BIER
 Length of blade
 270 mm
 complete with one saw
 blade each(23-118, 23-119 and 23-120)
 420 mm

Spare saw blades, carbon steel
 23-118 4 mm
 23-119 6 mm
 23-120 8 mm

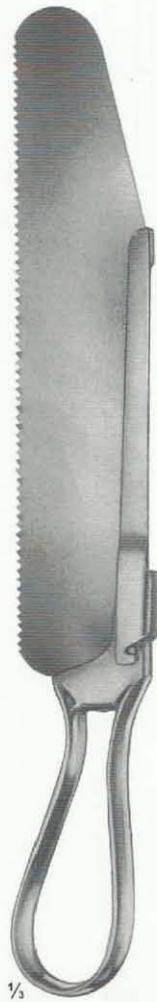

23-121
CHARRIERE
 Length of blade
 180 mm
 Spare saw blade,
 carbon steel (23-122)
 270 mm

23-123
CHARRIERE
 Length of blade
 240 mm
 Spare saw blade,
 carbon steel(23-124)
 340 mm



23-125
SATTERLEE
 Length of blade
 200 mm
 Spare saw blade,
 carbon steel(23-126)
 290 mm



23-127
LANGENBECK
 Length of blade
 115 mm
 Metacarpal saw
 235 mm



15.5 cm / 6"

- 23-128A 2 mm \emptyset
- 23-128B 3 mm \emptyset
- 23-128C 4 mm \emptyset
- 23-128D 5 mm \emptyset
- 23-128E 6 mm \emptyset
- 23-12F 8 mm \emptyset
- 23-128G 10 mm \emptyset



KIENNY
23-135A
17.5 cm / 7"



TRILLAT
23-135A 9 x 9 mm
23-135B 9 x 19 mm
20 cm / 8"



CYLINDRIQUES DOUBLE
23-137A 8 x 15 mm \emptyset
16 cm / 6 1/4"
23-137B 6 x 8 mm \emptyset
23-137C 10 x 12 mm \emptyset
21 cm / 8 1/4"

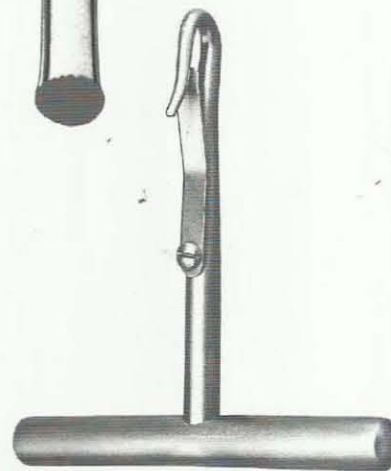

Gigli
23-136A
Handle with lock

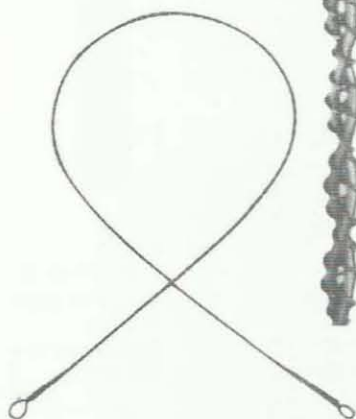

23-128 - 131
OLIVECRONA
23-128 300 mm
23-129 400 mm
23-130 500 mm
23-131 700 mm

5:1

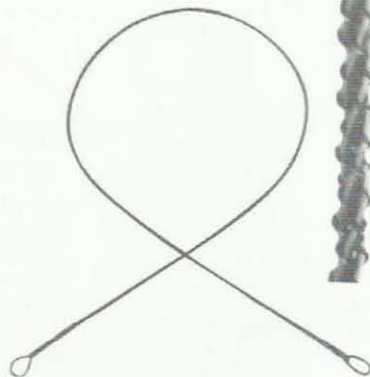

23-132 - 135
GIGLI
23-132 300 mm
23-133 400 mm
23-134 500 mm
fine, 6 wires twisted
23-135 500mm
coarse, 4 wires twisted

5:1



1/4

23-136
GIGLI
Handle



1/2

23-137
LEBSCHE
Conductor for
wire saws, malleable
250 mm



1/2
24-101 - 102
KOENIG
155 mm

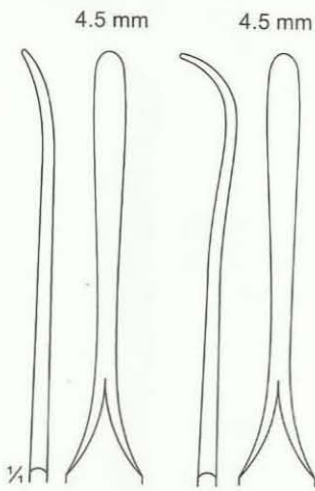

24-101

24-102



1/2
24-103
WILLIGER
165 mm



24-103



1/2
24-104
WILLIGER
170 mm

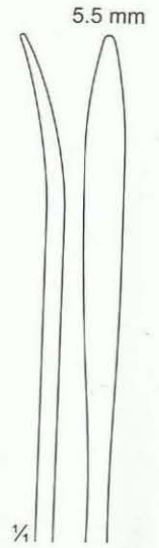

24-104



1/2
24-105
QUERVAIN
195 mm

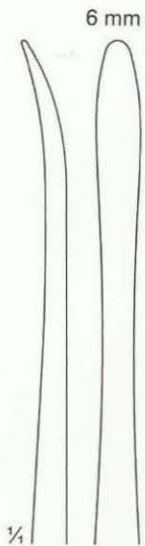

6 mm



1/2
24-106 - 107
LANGENBECK
195 mm

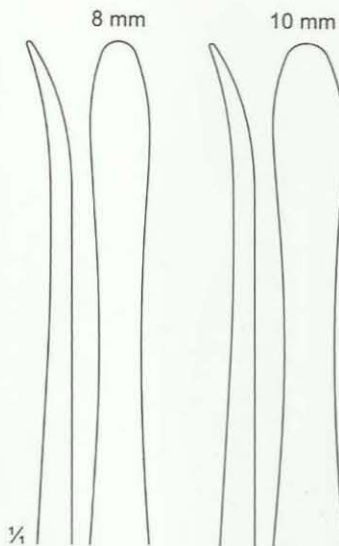

8 mm

10 mm

24-106

24-107



1/2
24-108
LANGENBECK
230mm

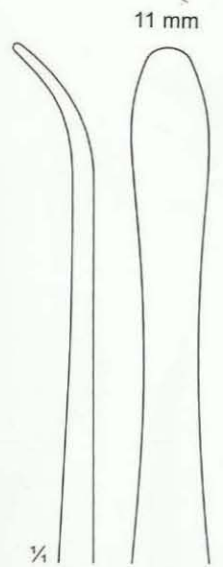

11 mm

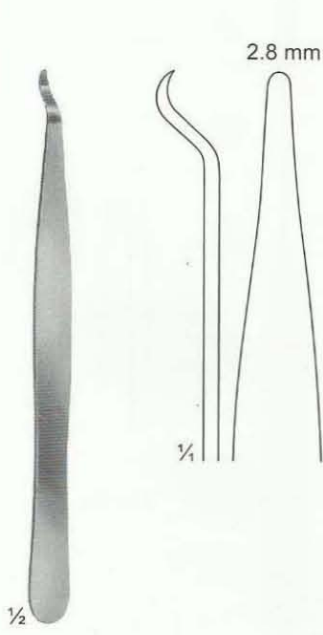

24-109
140mm

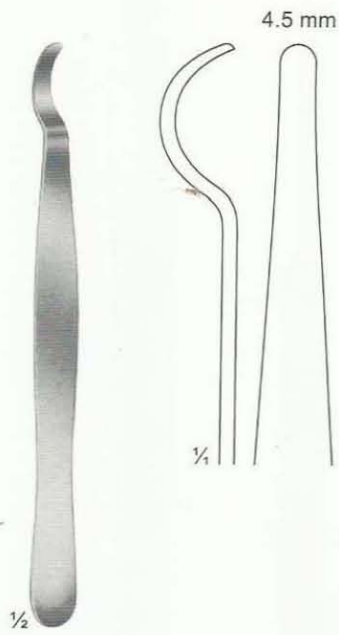

24-110
150mm

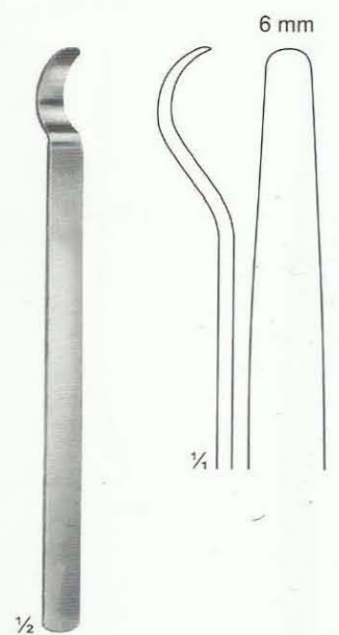

24-111
150mm

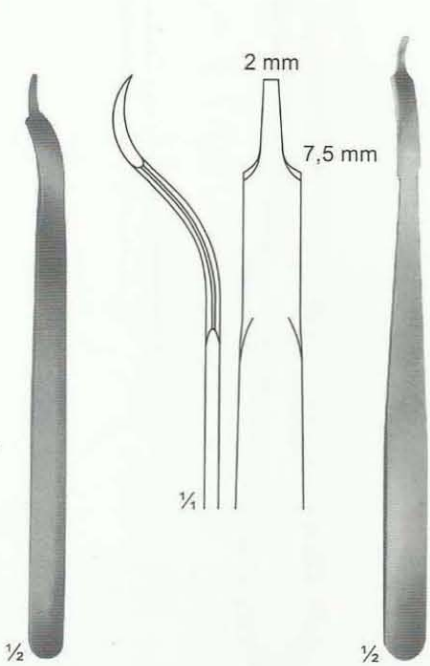

24-112
BUCK-GRAMCKO
150mm

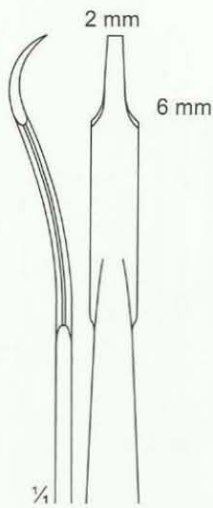

24-113
160mm

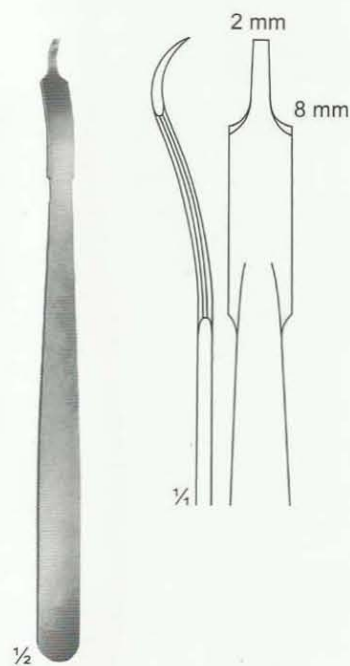

24-114
160mm

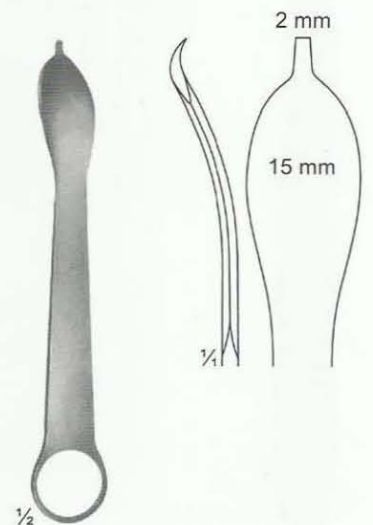

24-115
125mm

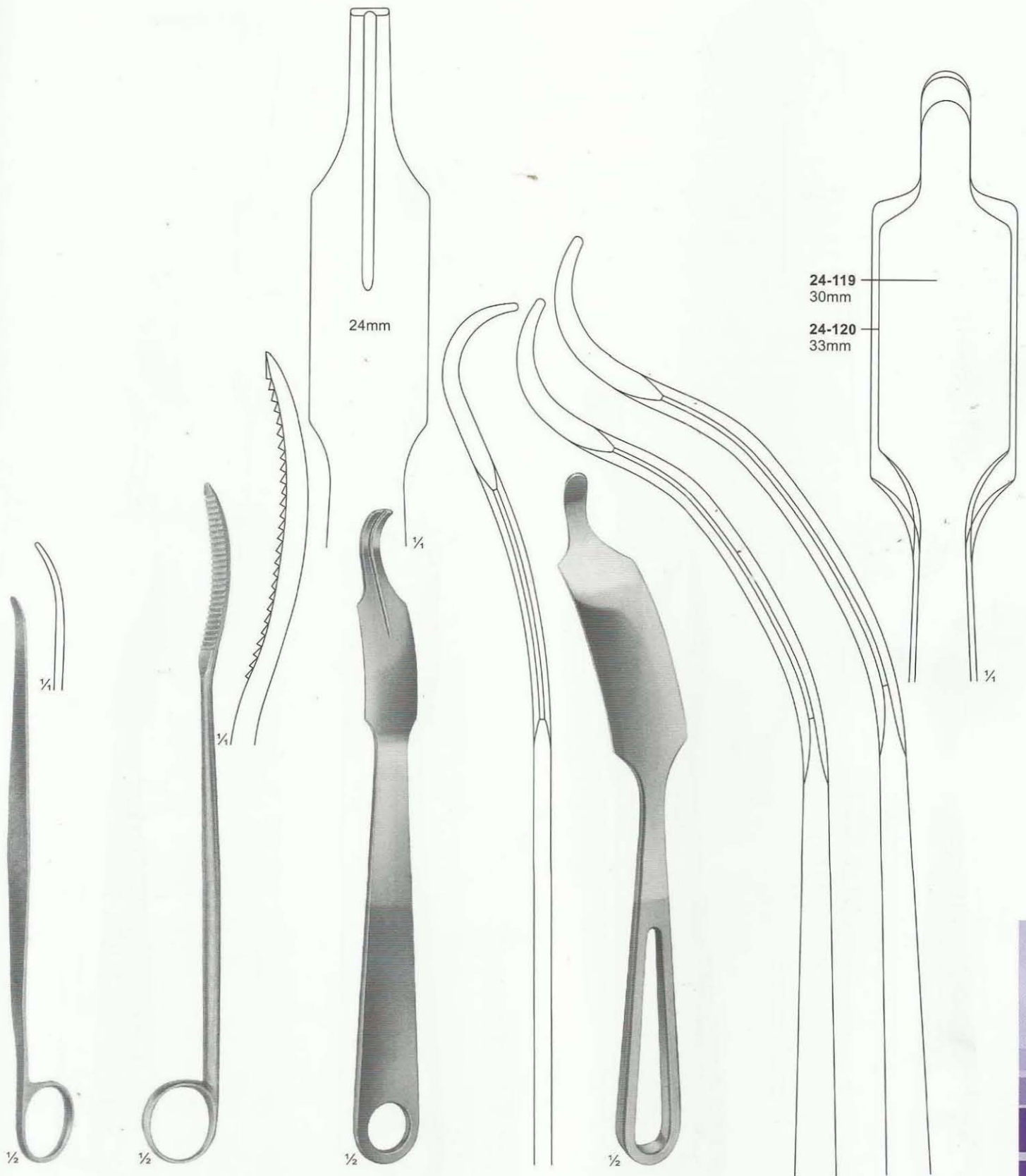

24-116
LANE TRETOWAN
215mm

24-117
LANE
255mm

24-118
LANGE-HOHMANN
250mm

24-119 - 120
LANGE-HOHMANN
modif
24-119 265mm
24-120 280mm



24-121
WAGNER
220 mm

24-122
220 mm

24-123
240 mm

24-124
240 mm

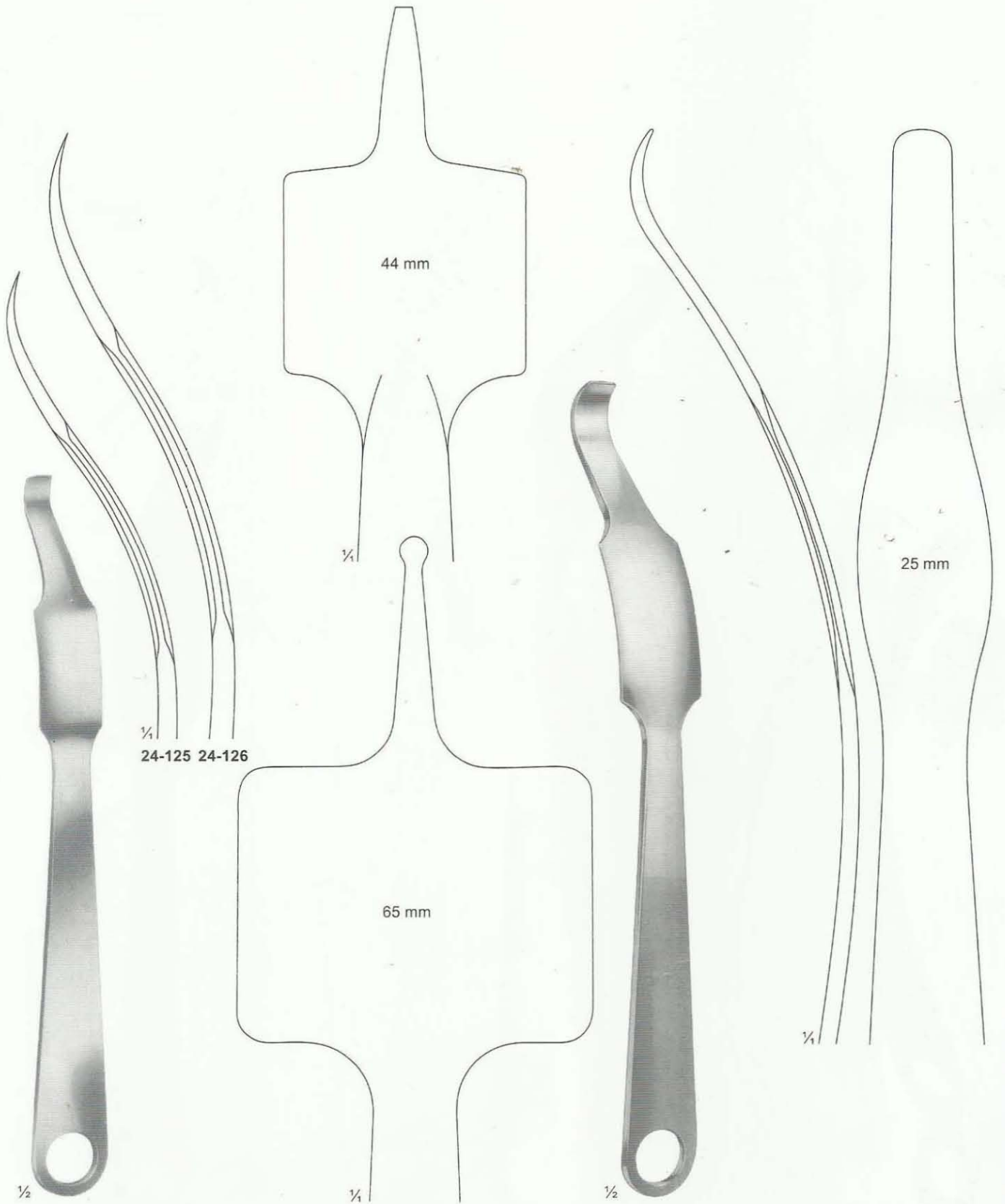

24-125 - 126
VERBRUGGE-MULLER
24-125 240 mm
24-126 255 mm

24-127
260 mm

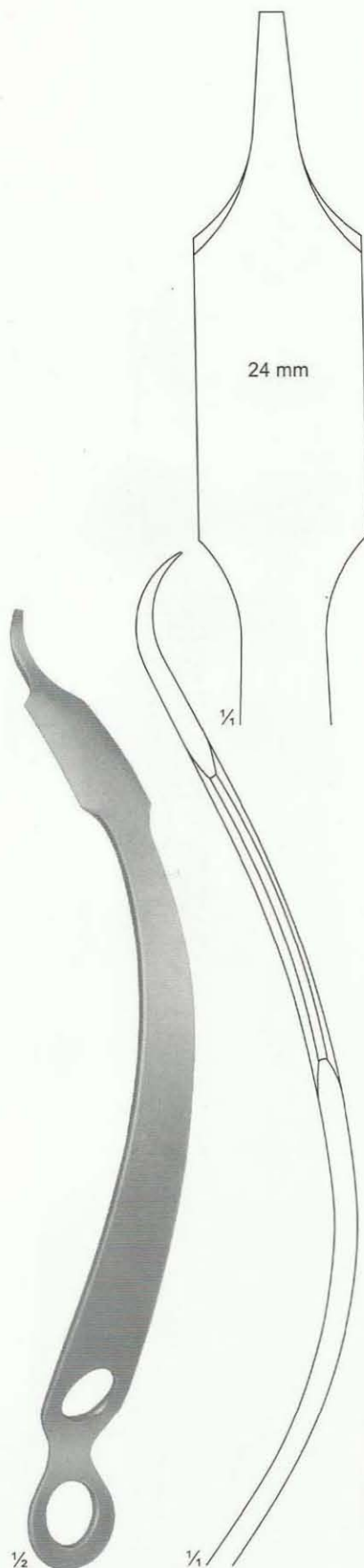

24-128
HOHMANN-ALDINGER
270

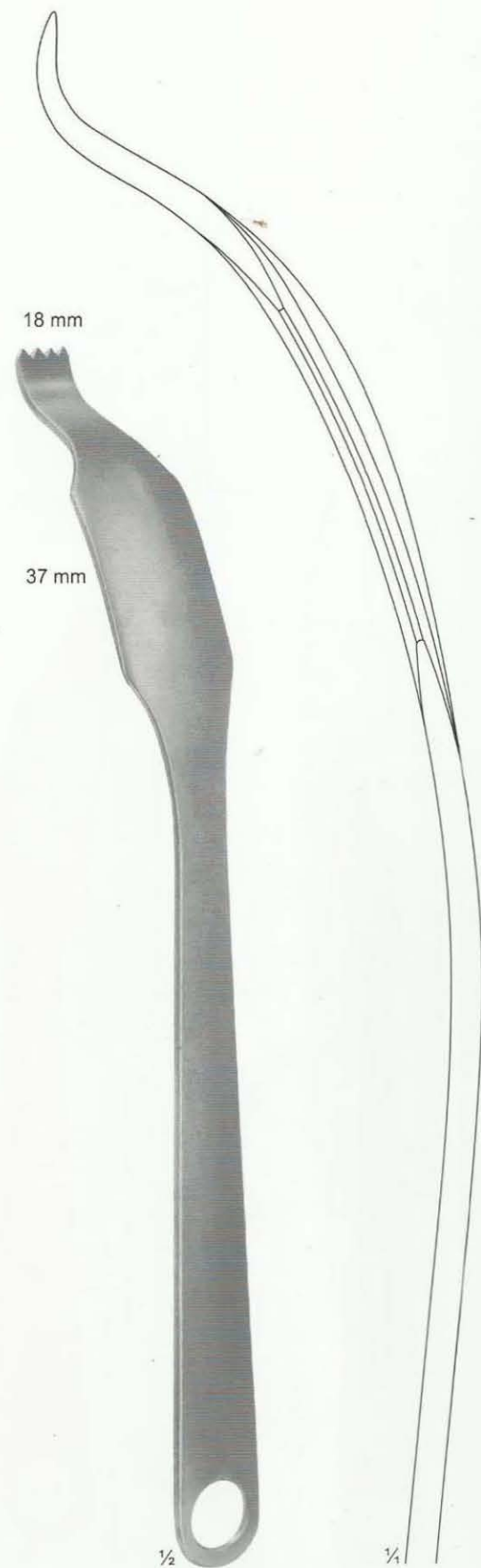

24-129
SCHUMACHER mod. WAGNER
245

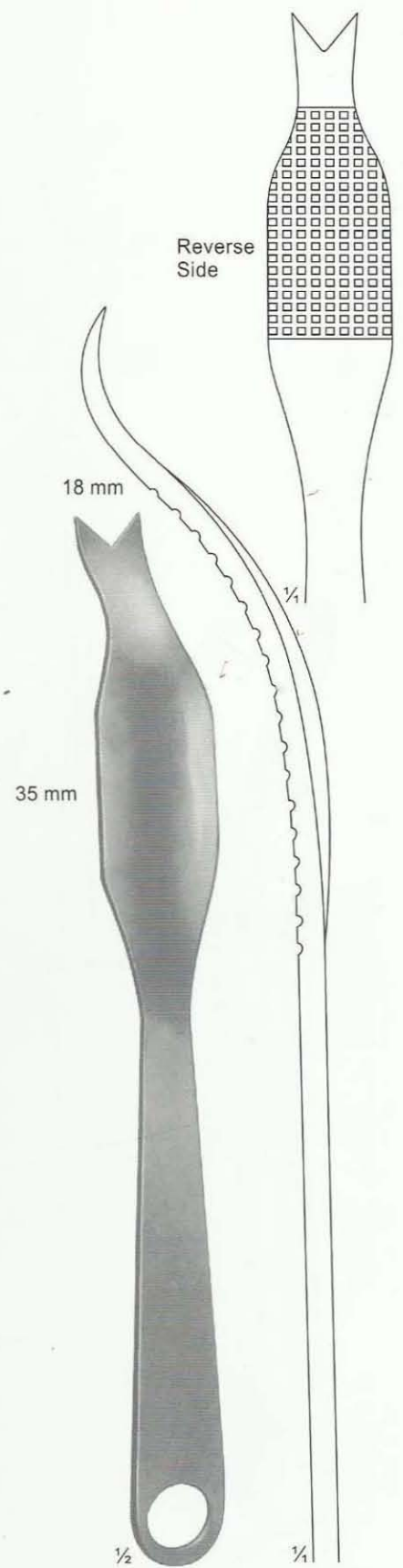

24-130
SCHUMACHER
260

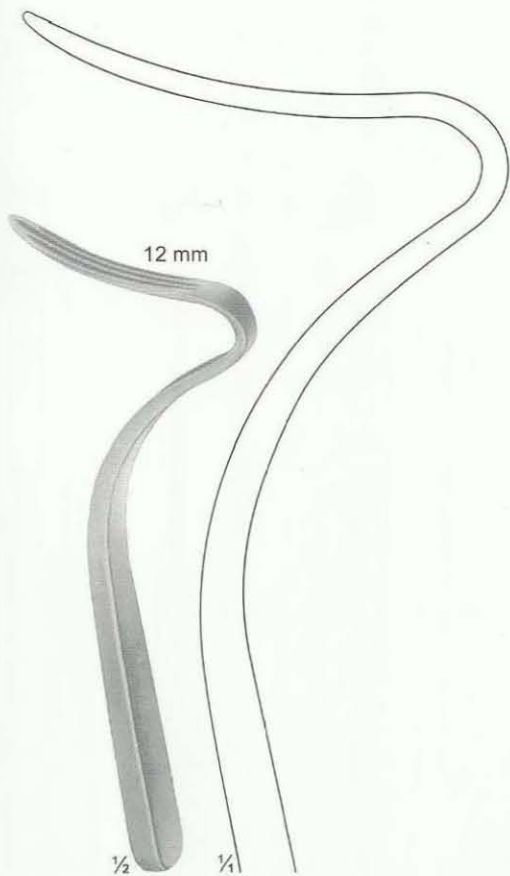

24-131
TAGER
 Bone lever for
 angle joint operations
 175 mm



24-132
BENNETT
 235 mm

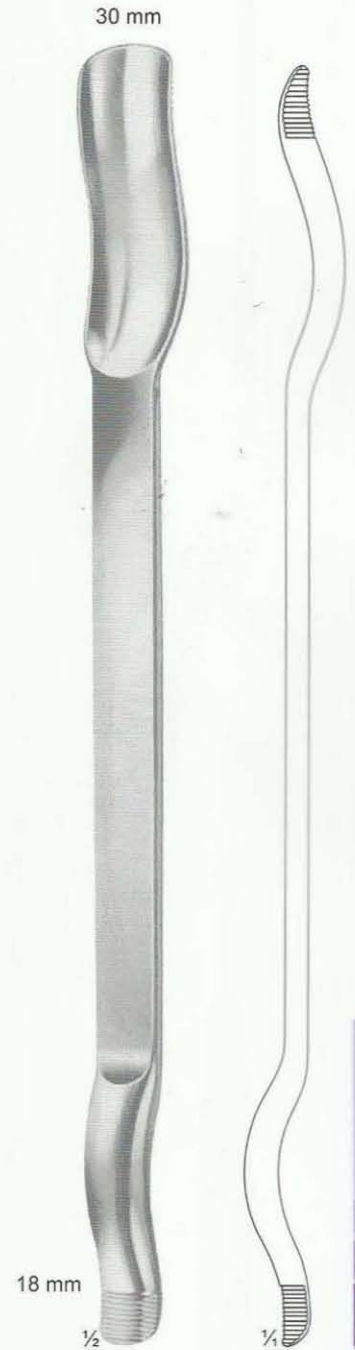

24-133
MURPHY-LANE
 Luxation lever
 340 mm

3,2 mm

4,6 mm

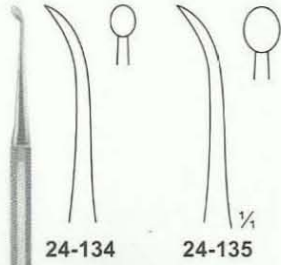

24-134

24-135

1/2

24-134 - 135
PARTSCH
150 mm

4 mm



1/4

1/2

24-136
PARTSCH mod. LANGE
145 mm

4,4 mm

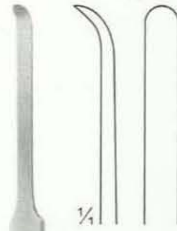

1/4

1/2

24-137
MC KENTY
155 mm

5 mm

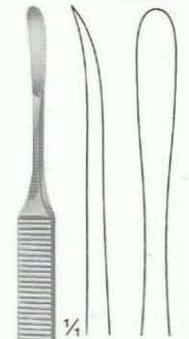

1/4

1/2

24-138
KOENIG
155 mm

8 mm

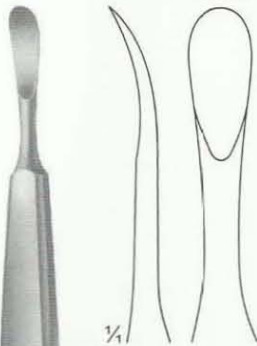

1/4

1/2

24-139
TRELAT
150 mm

4,2 mm

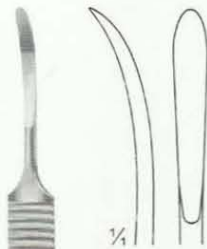

1/4

1/2

24-140
WILLIGER
140 mm

6 mm

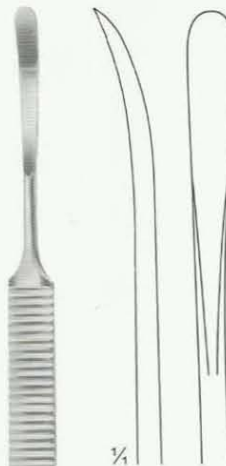

1/4

1/2

24-141
WILLIGER
160 mm

4 mm

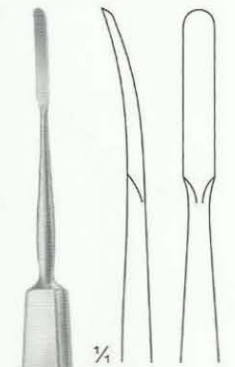

1/4

1/2

24-142
JOSEPH
170 mm

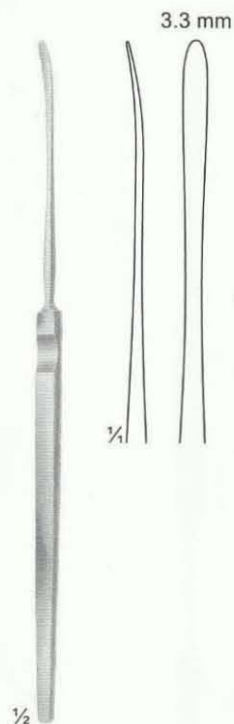

24-143
HALLE
blunt
180 mm



24-144
FREER
blunt
190 mm



24-145
FREER
sharp
190 mm



24-146
SEWALL
blunt
200 mm



24-147 - 149
PAULSEN
205 mm

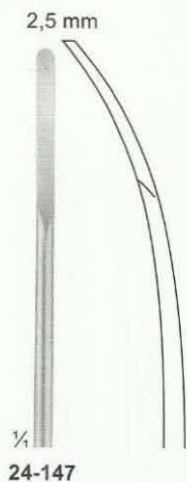

24-147

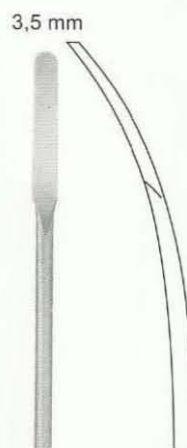

24-148



24-149



24-150 - 151
PAULSEN
205 mm



24-150

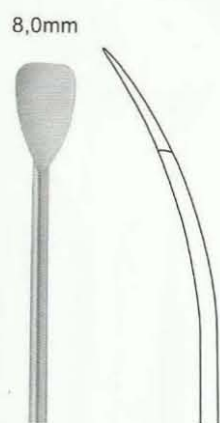

24-151

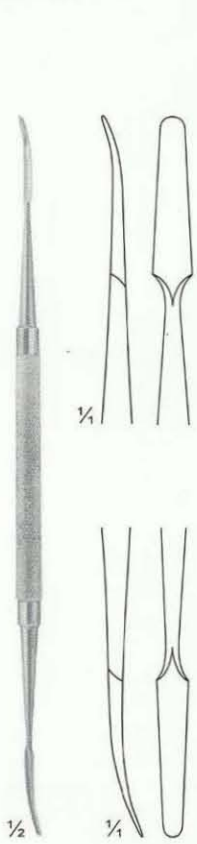

24-152
KILLIAN
sharp/blunt
185 mm

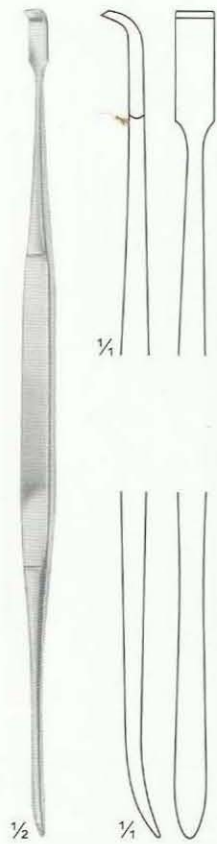

24-153
HOWARTH
sharp/blunt
215 mm

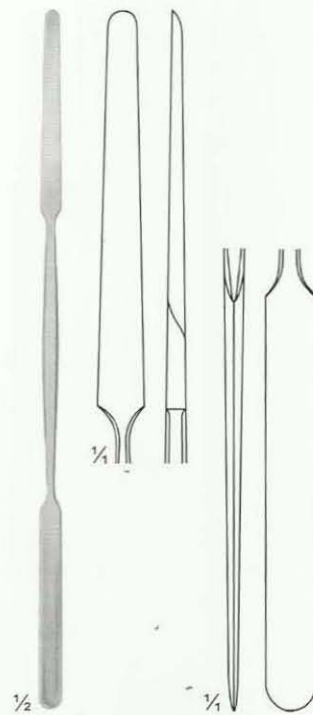

24-154
KILLIAN
sharp/blunt
185 mm

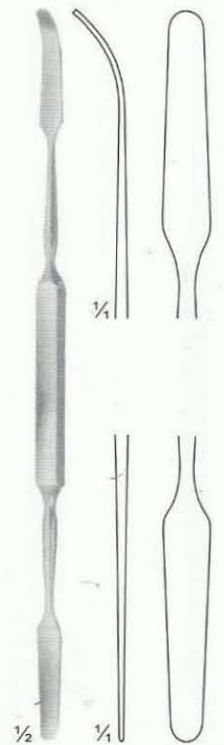

24-155
MAC DONALD
blunt/blunt
185 mm

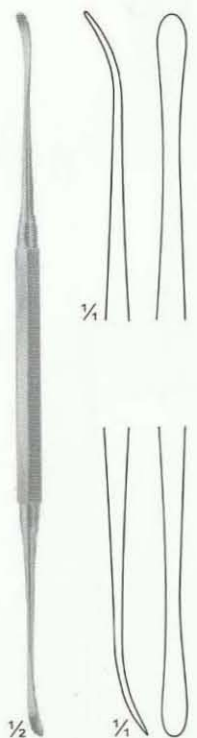

24-156
FREER
sharp/blunt

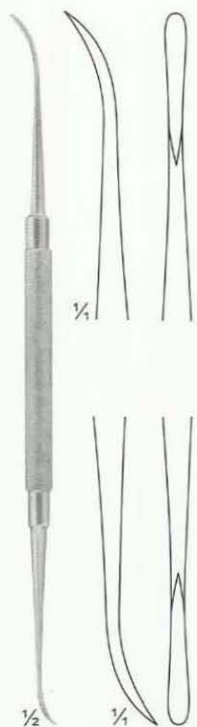

24-157
FREER-YASARGIL
sharp/sharp

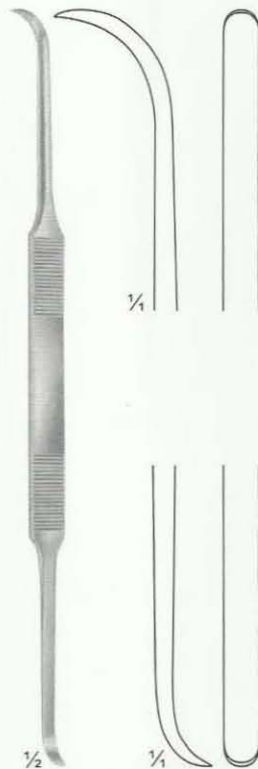

24-158
COTTLE
sharp/sharp

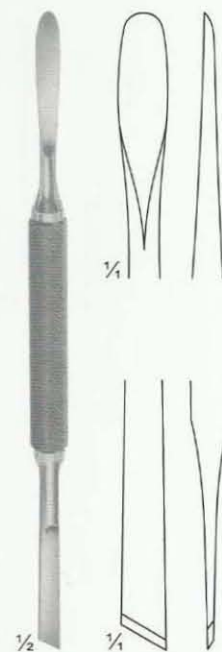

24-159
MEAD
sharp/sharp

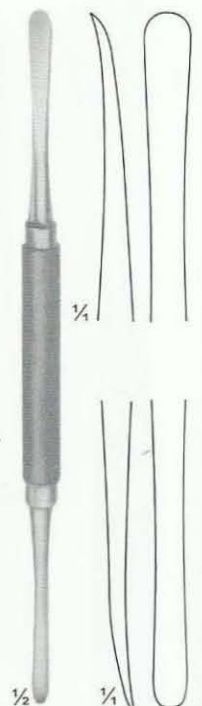

24-160
MOLT
sharp/sharp

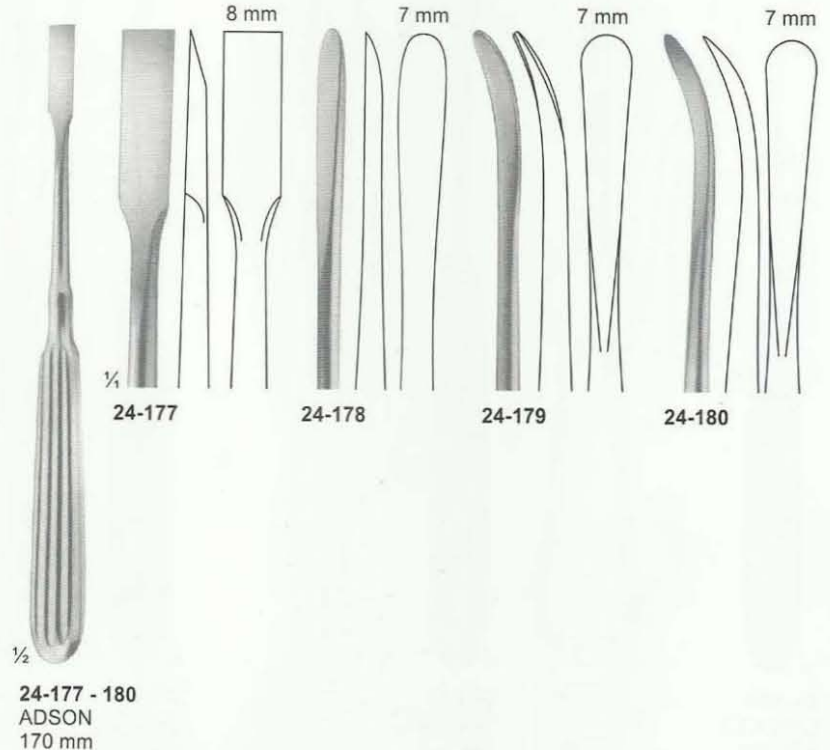
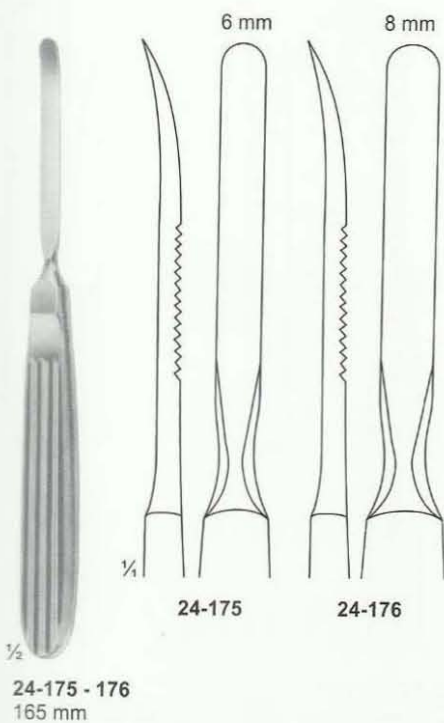
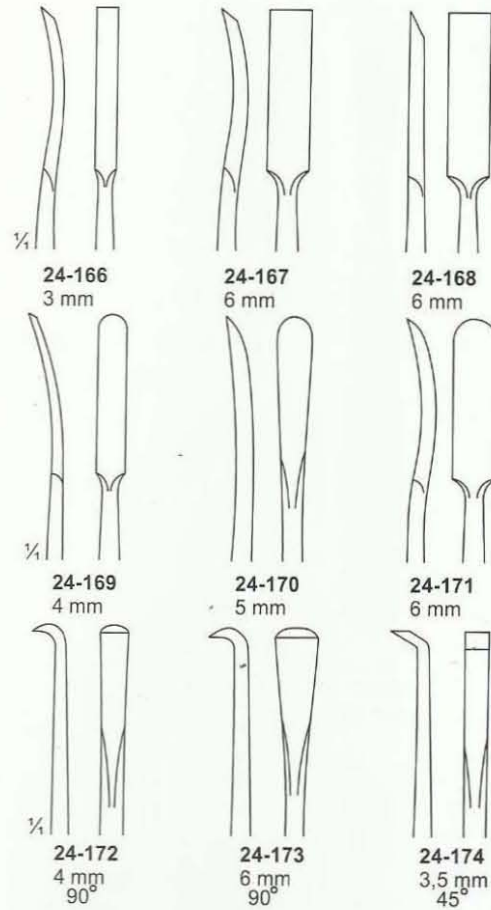
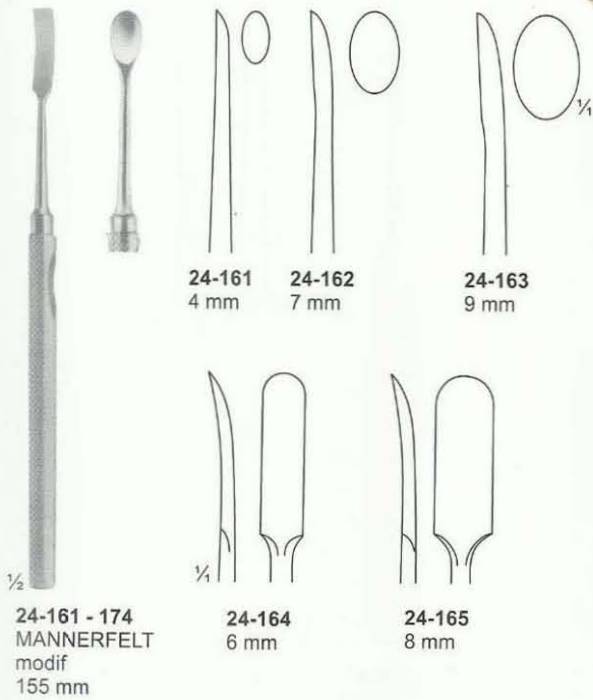

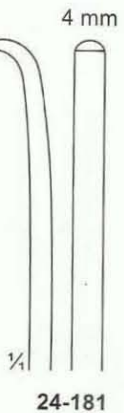

24-181

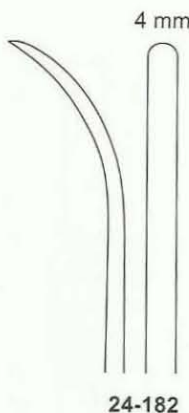

24-182

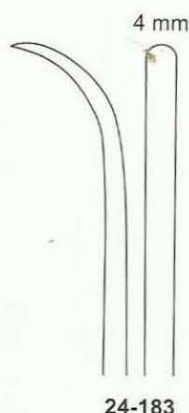

24-183

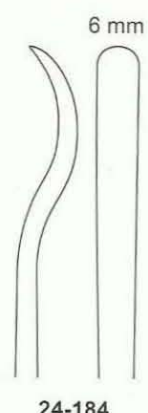

24-184

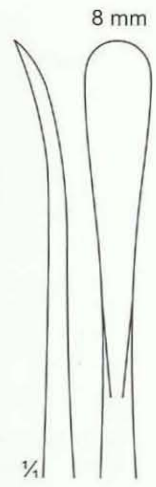

24-185
COTTLE
195 mm

24-181 - 184
MUEHLING
170 mm

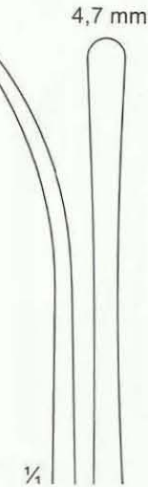

24-186
LANDOLT
175 mm

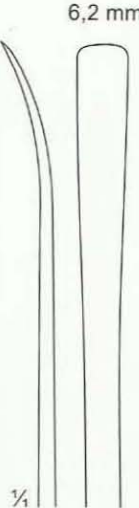

24-187
CASPAR
180 mm

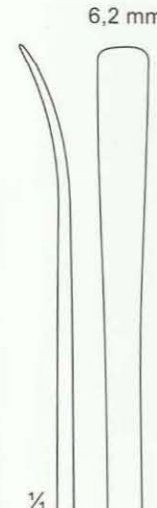

24-188
CASPAR
180 mm

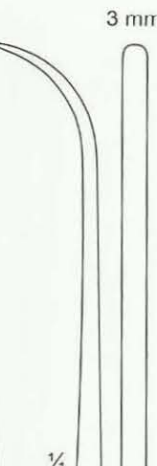

24-189 - 190
170 mm

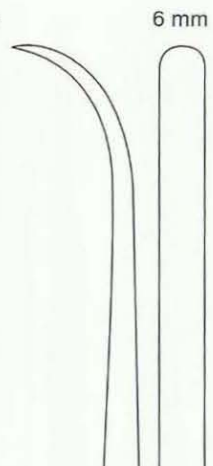

24-190

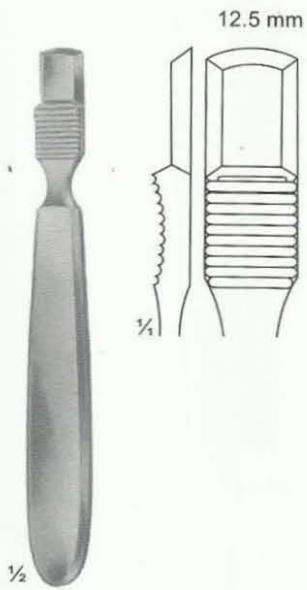

24-191
FARABEUF
140 mm

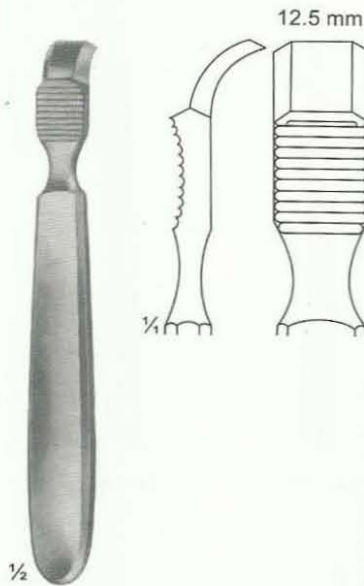

24-192
FARABEUF
140 mm

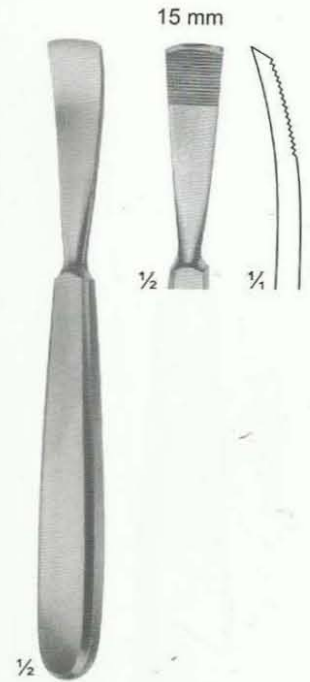

24-193
JANSEN
165 mm

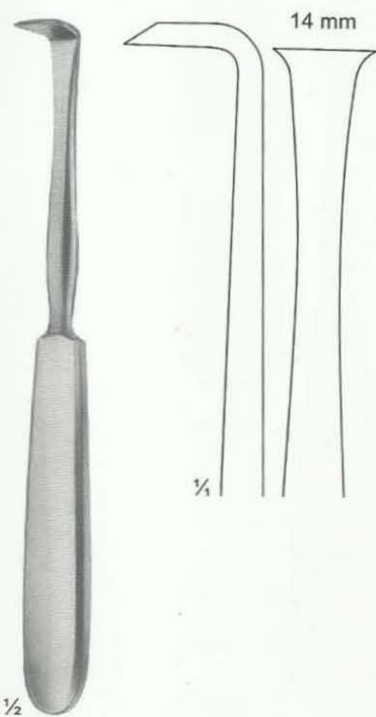

24-194
LANGENBECK
180 mm

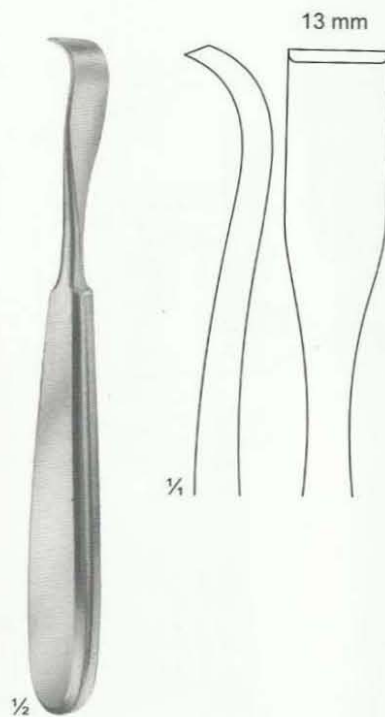

24-195
SCHNEIDER
175 mm

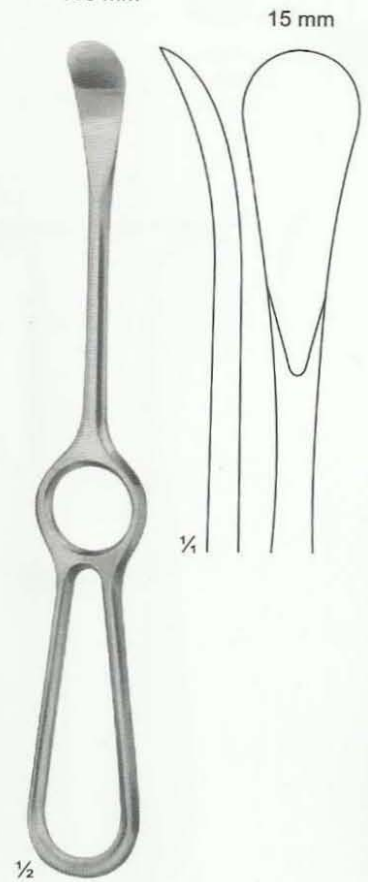

24-196
SEDILLOT
215 mm

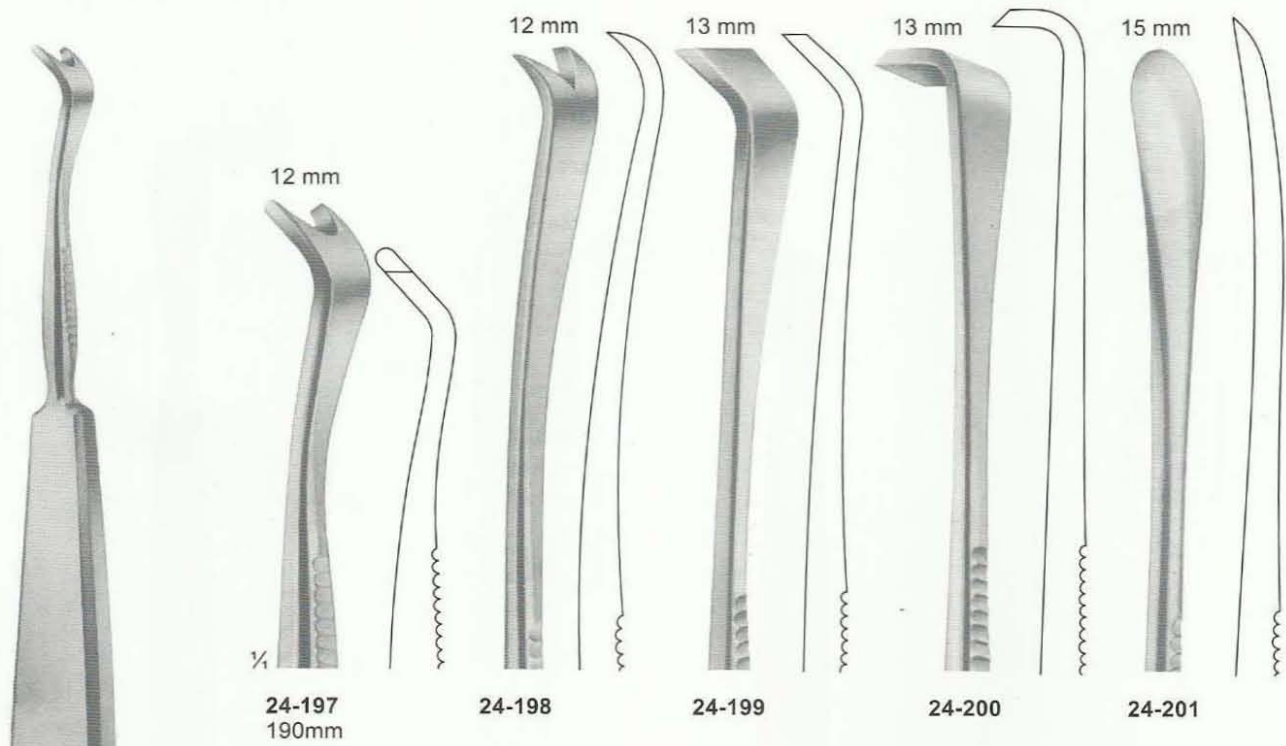

1/2
24-197 - 201
SEMB
230 mm

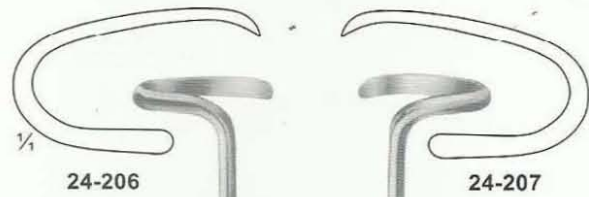

1/4
24-206

24-207



24-202

24-203

1/4
24-204

24-205

1/2

24-202 - 203
DOYEN
for children
24-204 - 205
for adults
175 mm

1/2

24-206 - 207
DOYEN



24-208
275 mm

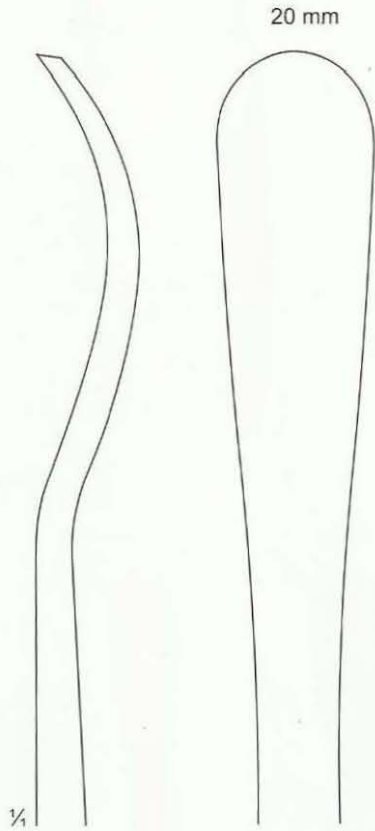

24-209 - 210
WAGNER
330 mm

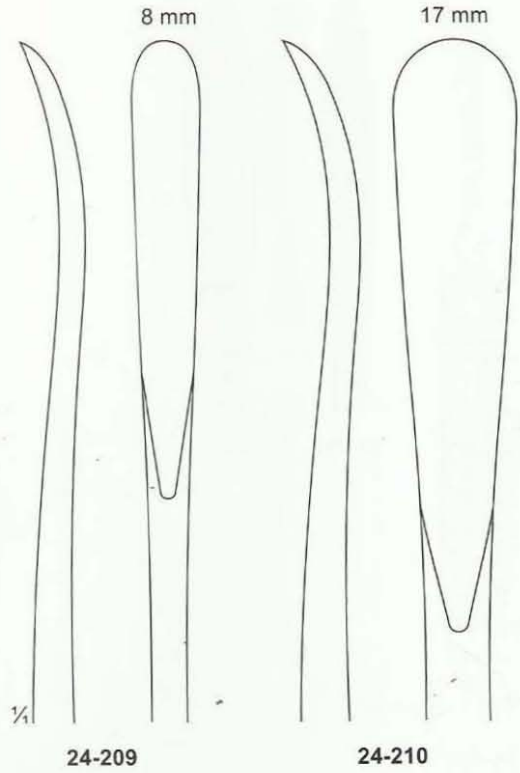

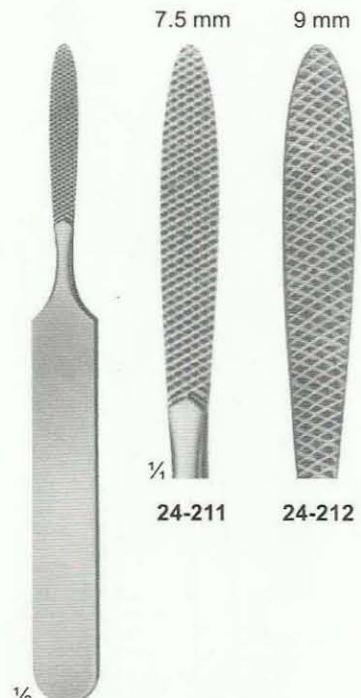

24-211
JOSEPH
fine, chequered

24-212
coarse, chequered
165 mm

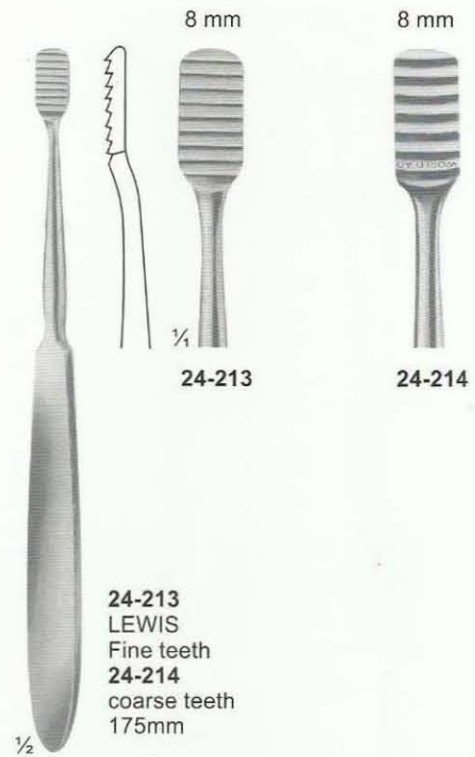

24-213
LEWIS
Fine teeth
24-214
coarse teeth
175mm



24-215
MALTZ
down stroke
180 mm

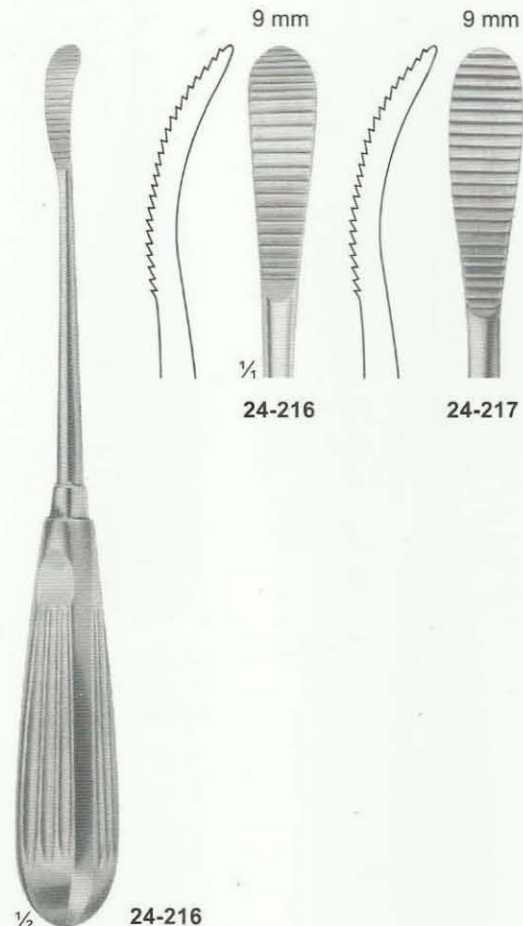

24-216
AUFRICHT
up stroke
24-217
down stroke
220 mm



24-218
GALLAHER
180 mm

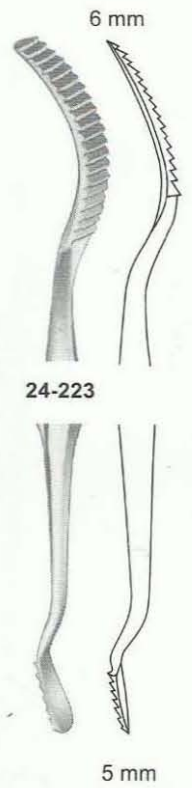
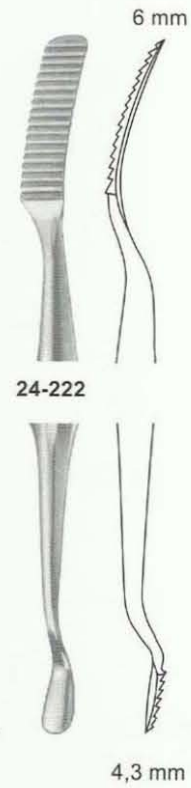
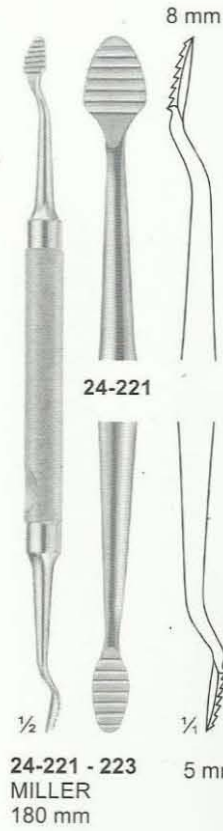
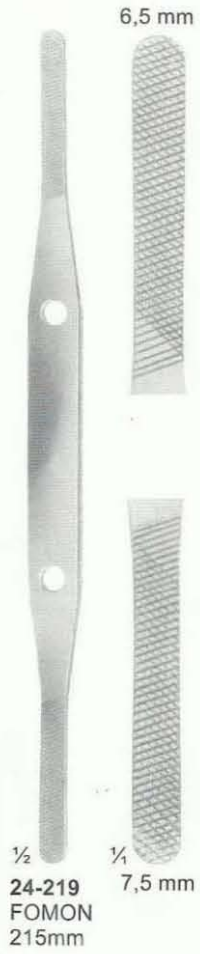



20 mm

1/2

24-229
220 mm



1/4

one side file cut
one side rasp cut



20 mm

1/2

24-230
295 mm

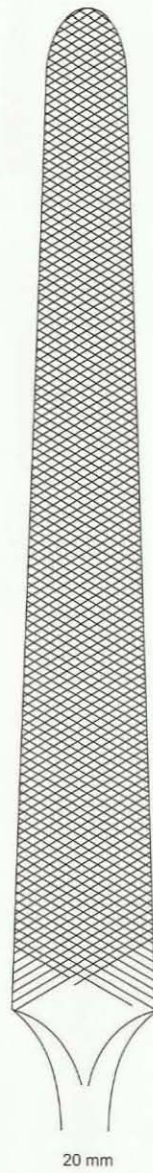

20 mm



13 mm

1/2

24-231
240 mm

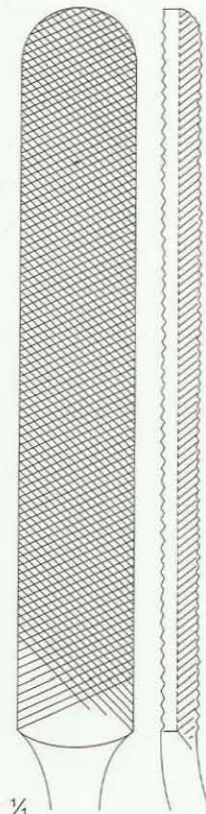

1/4

13 mm

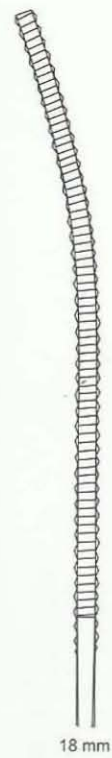

18 mm

1/2

24-232
PUTTI
270 mm



20 mm



24-233
JACOBSON
140 mm



24-234
MARTINI
140 mm

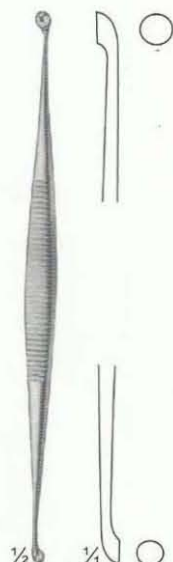

24-235
MARTINI
140 mm



24-236
WILLIGER
145 mm



24-237
JANSEN
160 mm



24-238
BARTH
180 mm

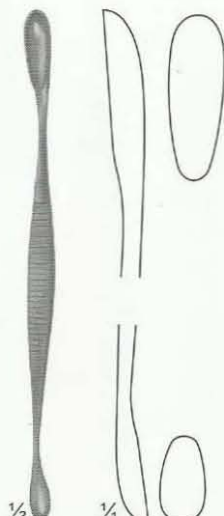

24-239
VOLKMANN
130 mm

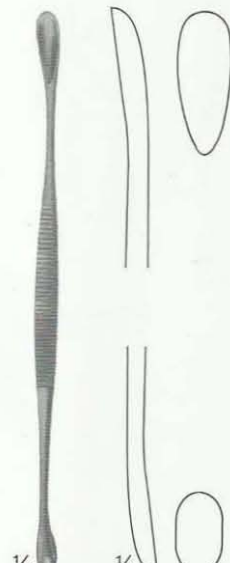

24-240
VOLKMANN
145 mm

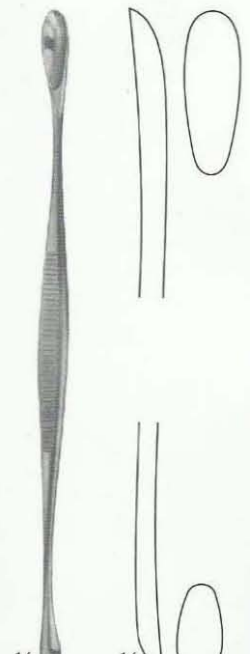

24-241
VOLKMANN
170 mm



24-242
JANSEN
160 mm



24-243
HEMINGWAY
170 mm



24-244
HEMINGWAY
175 mm



24-245
LUCAS
180 mm

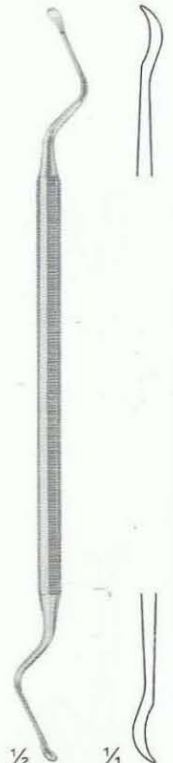

24-246
LUCAS
185 mm

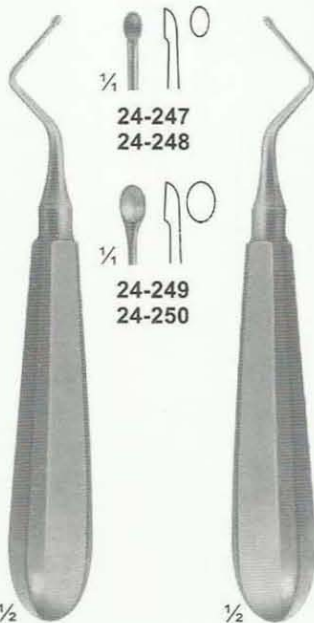

24-247 - 24-249
KERPEL

24-248 - 24-250
KERPEL

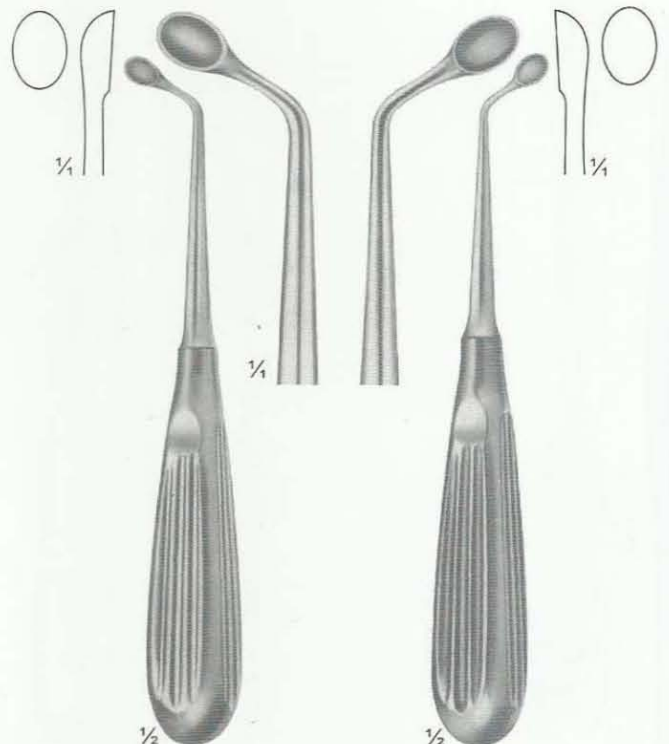

24-251
UFFENDORDE

24-252
UFFENDORDE



1/2

24-253 - 259
BRUNS
165 mm

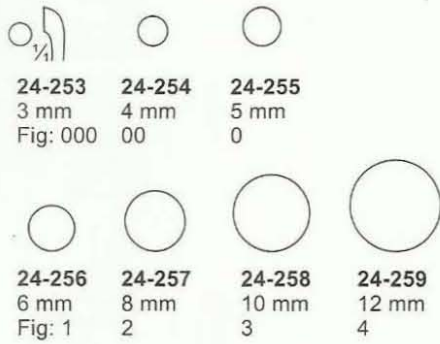

1/2

24-260 - 266
SCHEDE
170 mm

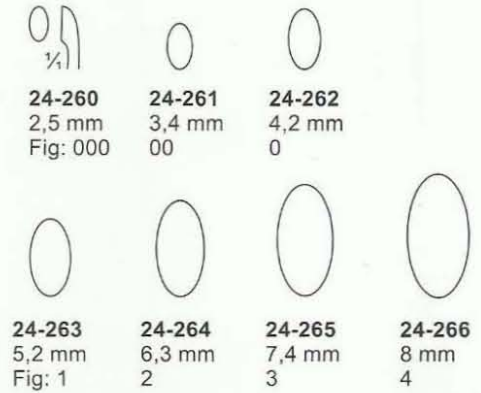

1/2

24-267 - 276
VOLKMANN
170 mm

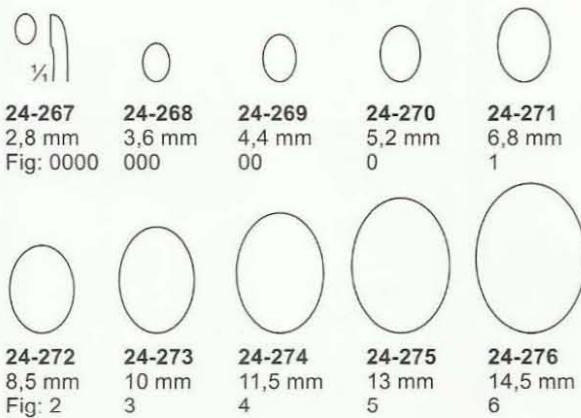

1/2

24-277 - 278
WILLIGER
170 mm -

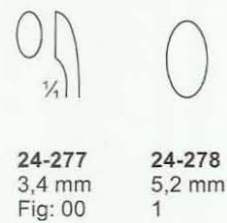



○
24-279
1,8 mm

○
24-280
2,0 mm

○
24-281
2,4 mm

○
24-282
2,6 mm

¼○
24-283
2,8 mm

24-279 - 283
LEMPERT
215 mm



○
24-284
4,4 mm
Fig: 00

○
24-285
5,2 mm
Fig: 0

¼○
24-286
6,8 mm
Fig: 1

24-284 - 286
HALLE
215 mm



○
24-287
2,8 mm
Fig: 0000

○
24-288
3,6 mm
Fig: 000

○
24-289
4,4 mm
Fig: 00

¼○
24-290
5,2 mm
Fig: 0

24-287 - 290
DAUBENSPECK
200 mm



○
24-291
3,6 mm
Fig: 000

○
24-292
4,4 mm
Fig: 00

○
24-293
5,2 mm
Fig: 0

¼○
24-294
6,8 mm
Fig: 1

24-291 - 294



○
24-295
3,6 mm
Fig: 000

○
24-296
4,4 mm
Fig: 00

○
24-297
5,2 mm
Fig: 0

¼○
24-298
6,8 mm
Fig: 1

24-295 - 298



○
24-299
3 mm

○
24-300
4 mm

¼○
24-301
5 mm

24-299 - 301

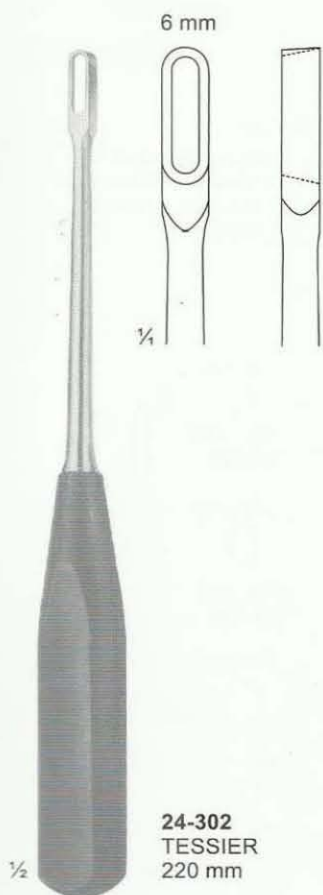

24-302
TESSIER
220 mm



24-303 - 305
SIMON
235 mm



24-306 - 311
SIMON
240 mm



24-312 - 314
CASPAR
220 mm







24-315 - 317
CASPAR
220 mm



24-318 - 320
CASPAR
toothed
220 mm









can be sterilized in a steam sterilizer upto 3 bar over pressure (143 C).



- 4,4 mm

 Fig. 00
24-321
- 6,8 mm

 Fig. 1
24-322
- 8,5 mm

 Fig. 2
24-323
- 10 mm

 Fig. 3
24-324

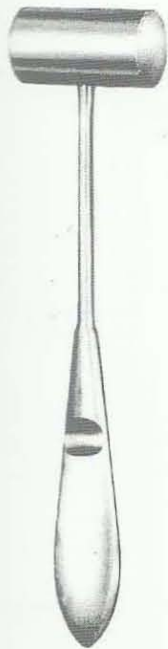
24-321 - 324
270 mm



- | | |
|---|---|
| 2,8 mm

Fig. 0000
24-325 | 2,8 mm

Fig. 0000
24-329 |
| 3,6 mm

Fig. 000
24-326 | 3,6 mm

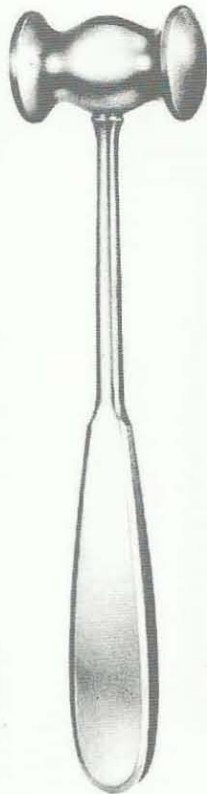
Fig. 000
24-330 |
| 5,2 mm

Fig. 0
24-327 | 5,2 mm

Fig. 0
24-331 |
| 10,0 mm

Fig. 3
24-328 | 10,0 mm

Fig. 3
24-332 |

24-325 - 332
SYPERT
380 mm



25-101
16.5 cm / 6½"
140 gm / 5 oz, 20 mm



Collin
25-102
20 cm / 8"
220 gm / 7¾ oz, 30 mm Ø



Williger
24 cm / 9½"

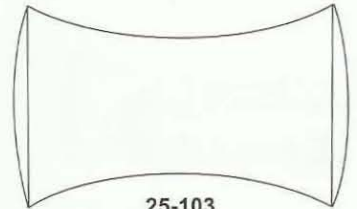

25-103
26 mm Ø
300 gm / 10½ oz

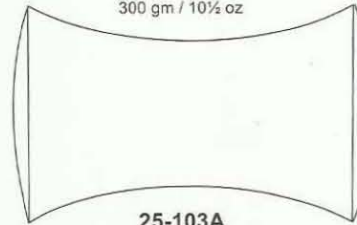

25-103A
28 mm Ø
340 gm / 12 oz



25-103B
30 mm Ø
400 gm / 14 oz

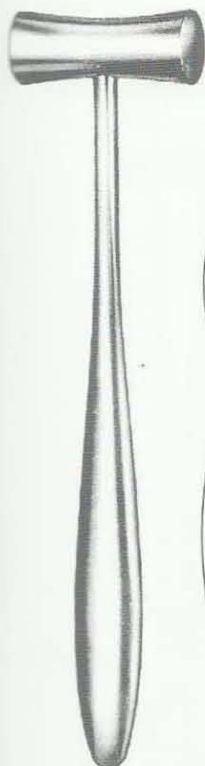

Lucae
19 cm / 7½"

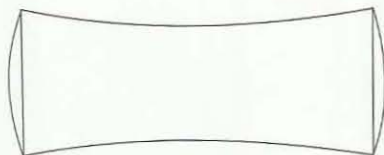

25-104
19 mm Ø
230 gm / 8 oz



25-105
25 mm Ø
260 gm / 9 oz

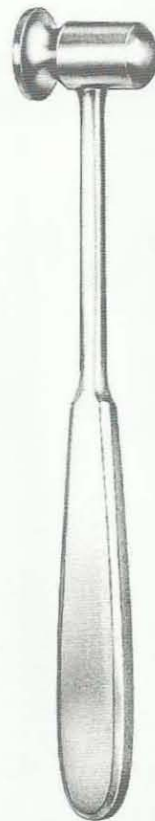

Doyen
21 cm / 8¼"

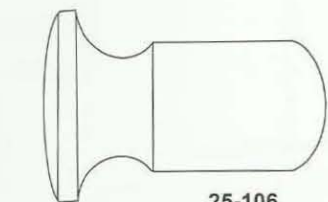

25-106
25 mm Ø
120 gm / 4½ oz

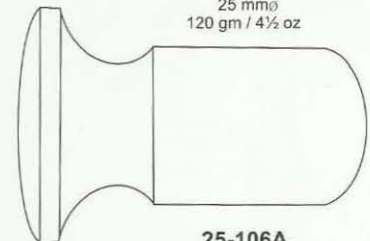

25-106A
30 mm Ø
180 gm / 6½ oz

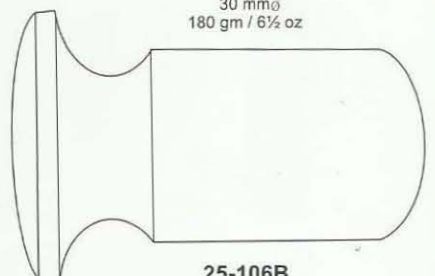

25-106B
35 mm Ø
260 gm / 9 oz

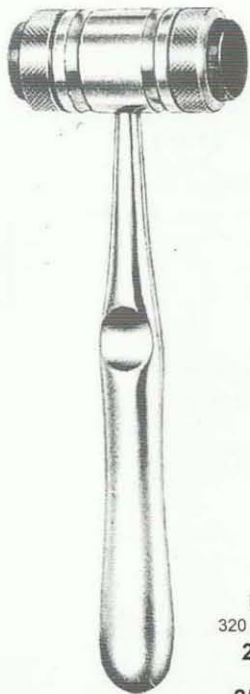

Mead
320 gm, 26 mm \emptyset
25-107
Solid
25-107A
17 cm / 6 $\frac{3}{4}$ "
Ferrozell faces only, pair

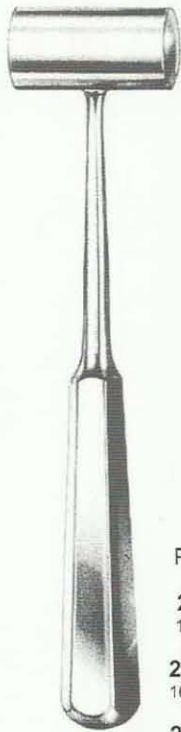

Partsch
22 mm \emptyset
25-108
18 cm / 7"
200 gm
25-108A
16 cm / 6 $\frac{1}{4}$ "
165 gm
25-108B
18 cm / 7"
220 gm

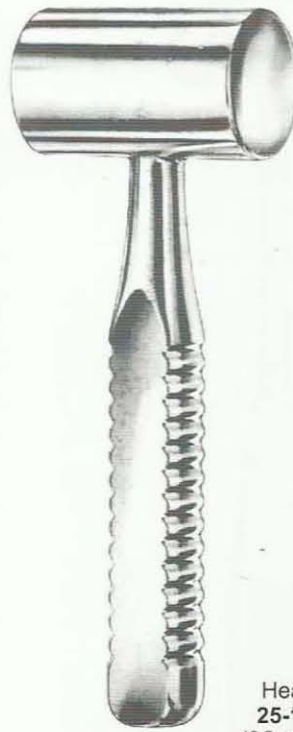

Heath
25-109
18.5 cm / 7 $\frac{1}{2}$ "
700 gm, 40 mm \emptyset
Cooper filled head

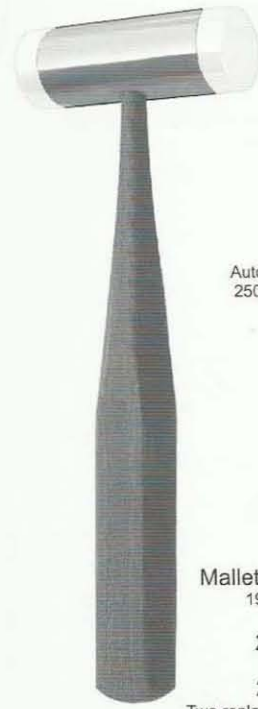

Autoclavable to
250°F (121°C)
Mallet Lightweight
19 cm / 7 $\frac{1}{2}$ "
25 mm \emptyset
25-110
140 gm
25-111
Two replaceable nylon caps
Total weight: 7 oz.
Head weight: 4 oz



25-112
Medium size hammer
Full aluminum



25-113
1000 gm
25-113A
700 gm
25-113B
500 gm

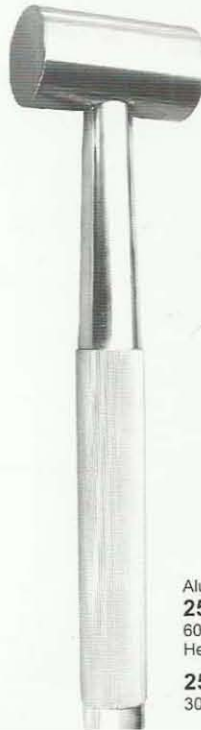

Aluminum handle
25-113C
600 gm, 22 oz
Heavy
25-113D
300 gm, 11 oz



Cottle
25-113E
19 cm / 7 $\frac{1}{2}$ "
240 gm, 30 mm \emptyset



25-114 450 gm
25-114A 900 gm



25-114B
26 cm / 10 1/2"
510 gm / 18 oz
30 mm ø



25-114C
Head weight 550 gm
Total weight 750 gm
40 mm ø



25-114D
Head weight 350 gm
Total weight 550 gm
35 mm ø

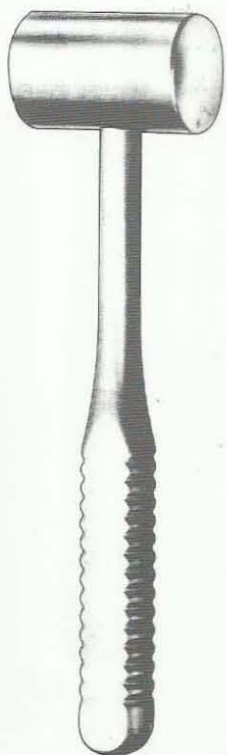

Ombredanne
25-114E
24 cm / 9 1/2"
550 gm, 40 mm ø

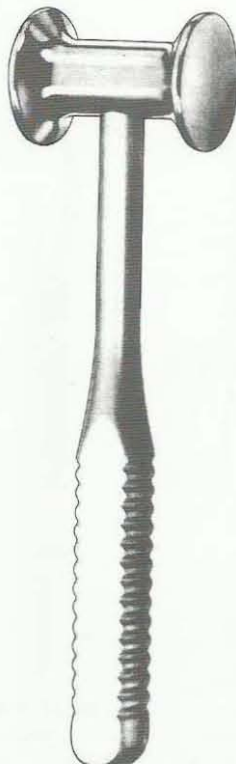

Bergmann
25-114F
24.5 cm / 9 3/4"
300 gm, 45 mm ø

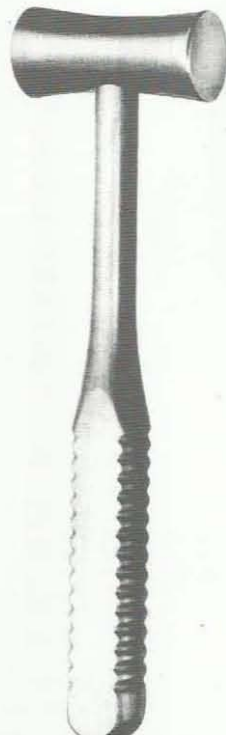

Bergmann
25-114G
23.5 cm / 9 1/4"
300 gm, 30 mm ø

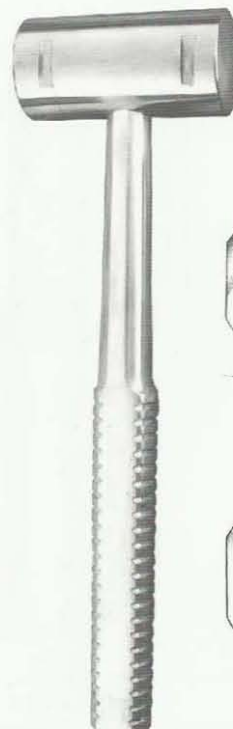

Wagner
25-115
23.5 cm / 9 1/4"
35 mm ø

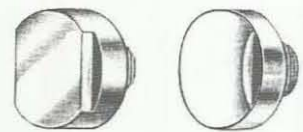

Metal head
25-116
230 gm, 35 mm ø

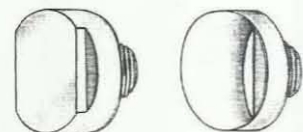

Plastic head
25-117
32 gm, 35 mm ø

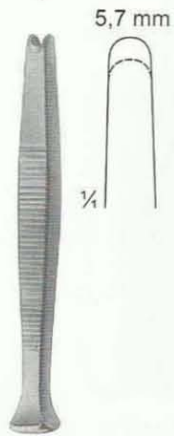

25-118
HAASE
100 mm

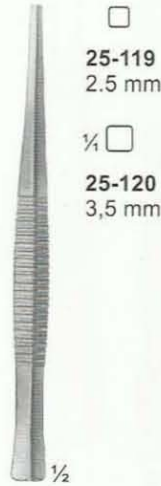

25-119 - 120
PASSOW
120 mm



25-121 - 123
CASPAR
200 mm

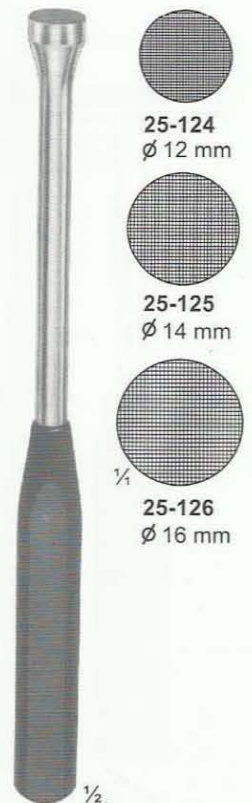

25-124 - 126
200 mm



25-127 4mm
FREER
Chisel
160 mm

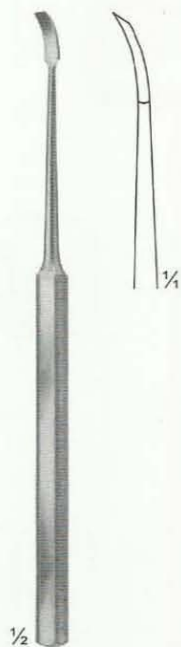

25-128 4mm
FREER
Chisel, curved
160 mm

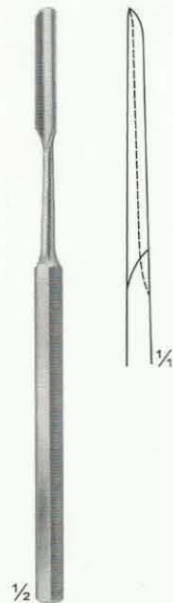

25-129 6mm
FREER
Gouge
150 mm

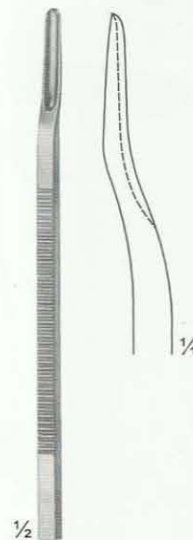

25-130 3.4mm
Scaphoid gouge,
downwards curved
135 mm

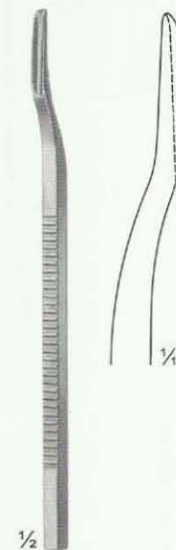

25-131 3.4mm
Scaphoid gouge,
upwards curved
135 mm



25-132 - 134
MANNERFELT modif
Osteotomes
25-132 4 mm
25-133 6 mm
25-134 8 mm
155 mm



25-135 3mm
MANNERFELT modif.
Gouge
155 mm

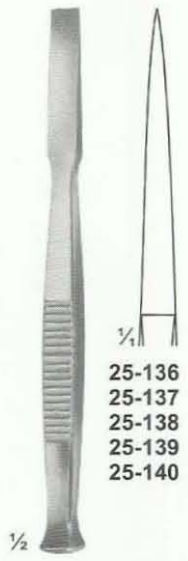

25-136 - 140
Osteotomes
140 mm

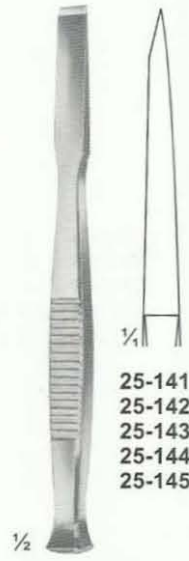

25-141 - 145
Chisels
140 mm

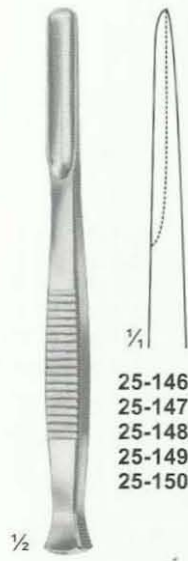

25-146 - 150
Gouges
140 mm

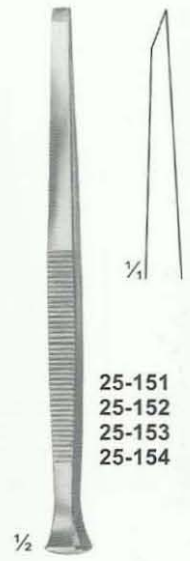

PARTSCH
25-151 - 154
Chisels
140 mm

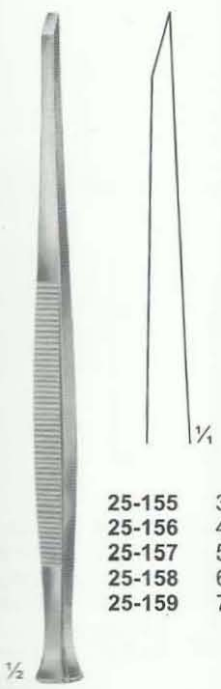

PARTSCH
25-155 - 159
Chisels
170 mm

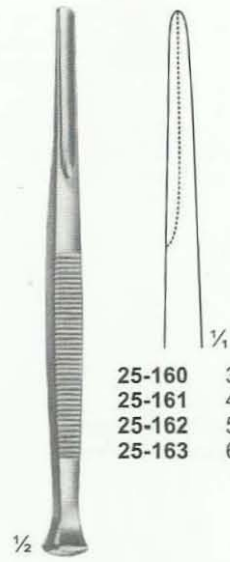

PARTSCH
25-160 - 163
Gouges
140 mm

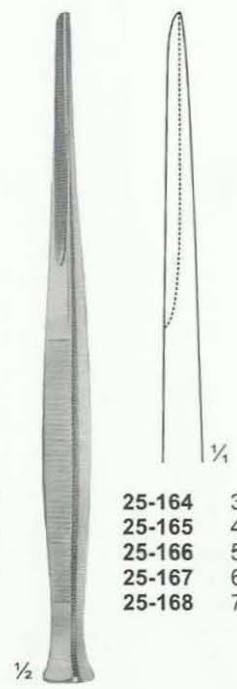

PARTSCH
25-164 - 168
Gouges
170 mm

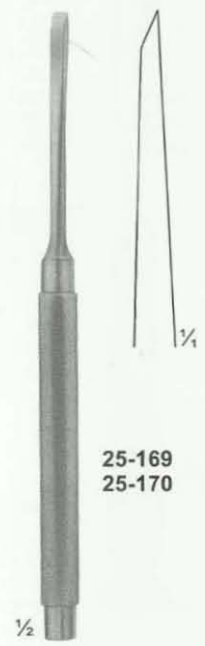

LUCAS
25-169 - 170
Chisels
160 mm

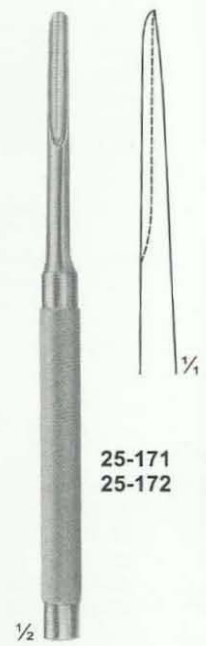

LUCAS
25-171 - 172
Gouges
160 mm

Osteotomes Chisels and Gouges

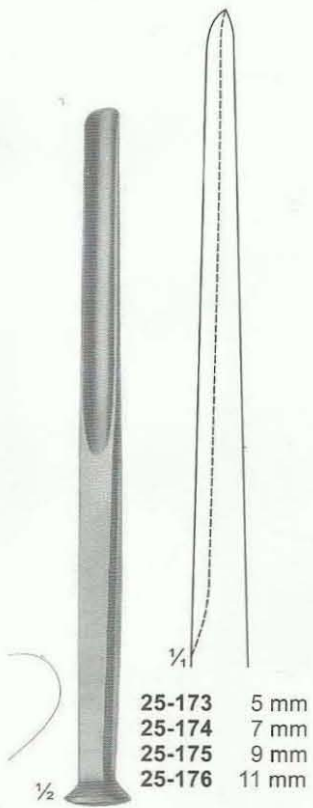

25-173 5 mm
25-174 7 mm
25-175 9 mm
25-176 11 mm

ALEXANDER
25-173 - 176
Gouges
170 mm

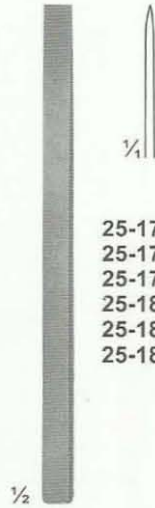

25-177 4 mm
25-178 6 mm
25-179 8 mm
25-180 10 mm
25-181 12 mm
25-182 15 mm

LAMBOTTE
25-177 - 182
Osteotomes
125 mm

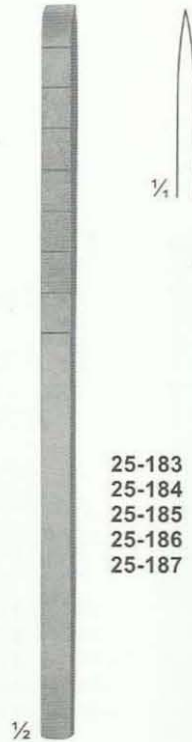

25-183 4 mm
25-184 6 mm
25-185 8 mm
25-186 10 mm
25-187 12 mm

COTTLE
25-183 - 187
Osteotomes with depth
markings
180 mm

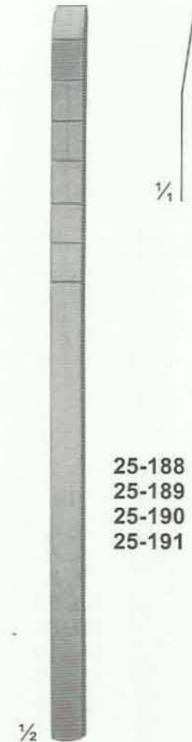

25-188 4 mm
25-189 7 mm
25-190 9 mm
25-191 12 mm

COTTLE
25-188 - 191
Chisel-Osteotomes
with depth markings
180 mm



COTTLE
25-192 8mm
Fishtail Chisel,
with protected ends
180 mm

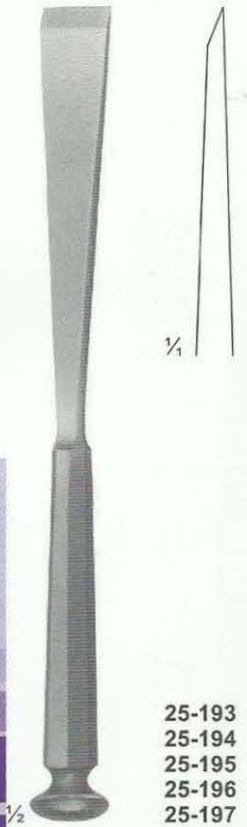

25-193 10 mm
25-194 12 mm
25-195 15 mm
25-196 20 mm
25-197 25 mm

STILLE
25-193 - 197
Chisels
205 mm

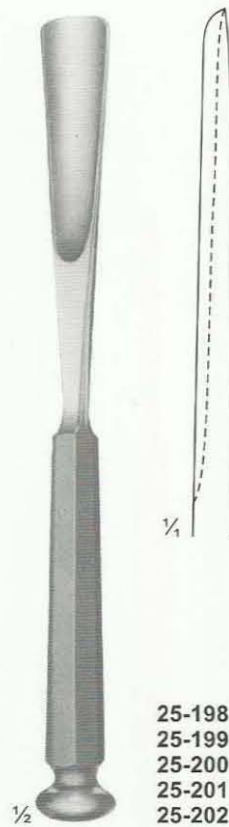

25-198 10 mm
25-199 12 mm
25-200 15 mm
25-201 20 mm
25-202 25 mm

STILLE
25-198 - 202
Gouges
205 mm

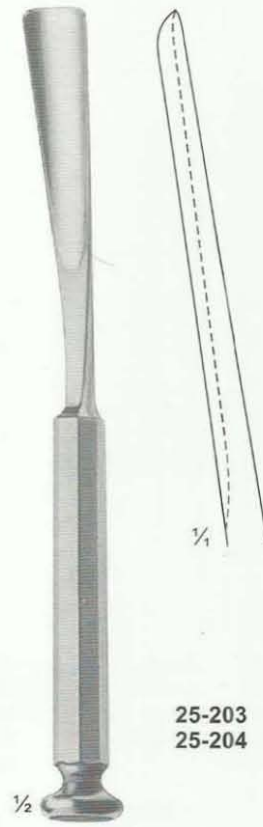

25-203 10 mm
25-204 15 mm

WALTER
25-203 - 204
gouges for taking
grafts from the ribs
205 mm

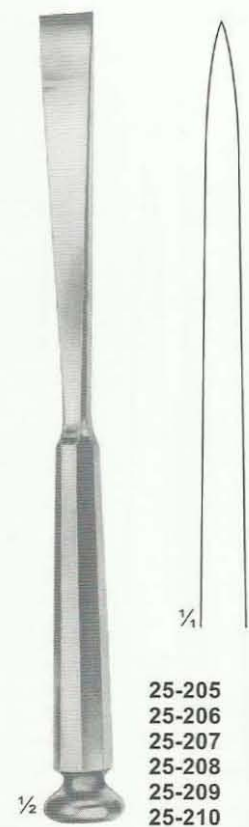

25-205 8mm
25-206 10 mm
25-207 12 mm
25-208 15 mm
25-209 20 mm
25-210 25 mm

STILLE
25-205 - 210
Osteotomes
205 mm

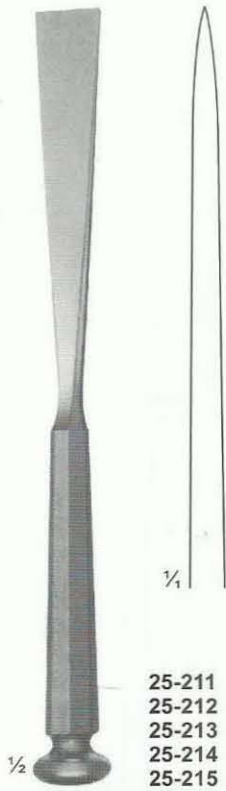

- 25-211 10 mm
- 25-212 12 mm
- 25-213 15 mm
- 25-214 20 mm
- 25-215 25 mm

STILLE
25-211 - 215
Osteotomes
205 mm

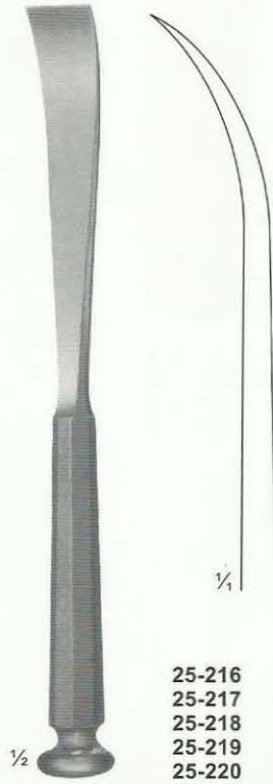

- 25-216 10 mm
- 25-217 12 mm
- 25-218 15 mm
- 25-219 20 mm
- 25-220 25 mm

STILLE
25-216 - 220
Osteotomes, curved
205 mm



- 25-221 4 mm
- 25-222 8 mm
- 25-223 10 mm
- 25-224 13 mm
- 25-225 15 mm
- 25-226 18 mm
- 25-227 20 mm
- 25-228 25 mm
- 25-229 30 mm
- 25-230 38 mm
- 25-231 44 mm
- 25-232 50 mm

LAMBOTTE
25-221 - 232
Osteotomes
245 mm



- 25-233 8 mm
- 25-234 13 mm
- 25-235 18 mm
- 25-236 25 mm
- 25-237 30 mm
- 25-238 38 mm

LAMBOTTE
25-233 - 238
Osteotomes, curved
245 mm

Osteotomes, chisels And Gouges
With Hartpress -handle

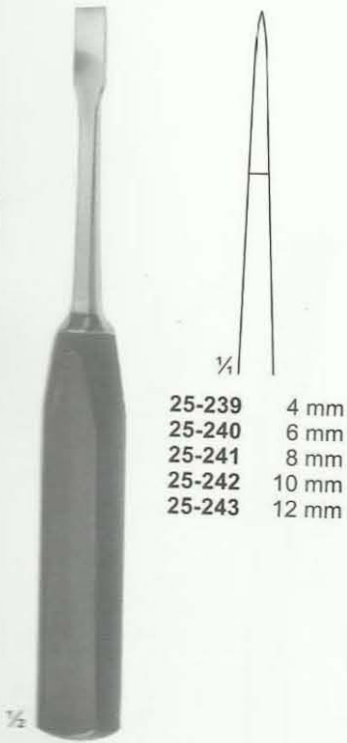

- 25-239 4 mm
- 25-240 6 mm
- 25-241 8 mm
- 25-242 10 mm
- 25-243 12 mm

LEXER-MINI
25-239 - 243
Osteotomes
180 mm

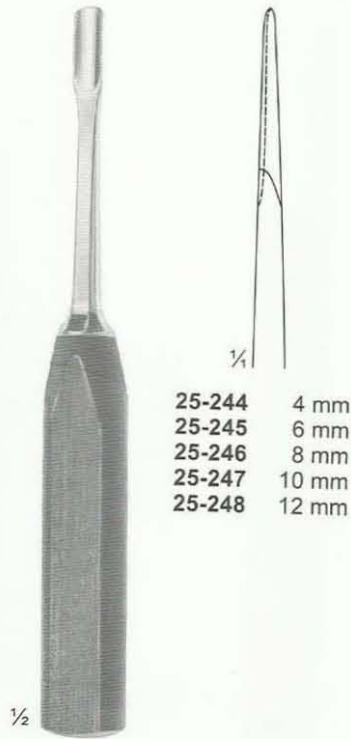

- 25-244 4 mm
- 25-245 6 mm
- 25-246 8 mm
- 25-247 10 mm
- 25-248 12 mm

LEXER-MINI
25-244 - 248
Gouges
180 mm



- 25-249 5 mm
- 25-250 7 mm
- 25-251 10 mm
- 25-252 15 mm
- 25-253 20 mm
- 25-254 25 mm
- 25-255 30 mm

LEXER
25-249 - 255
Gouges
220 mm

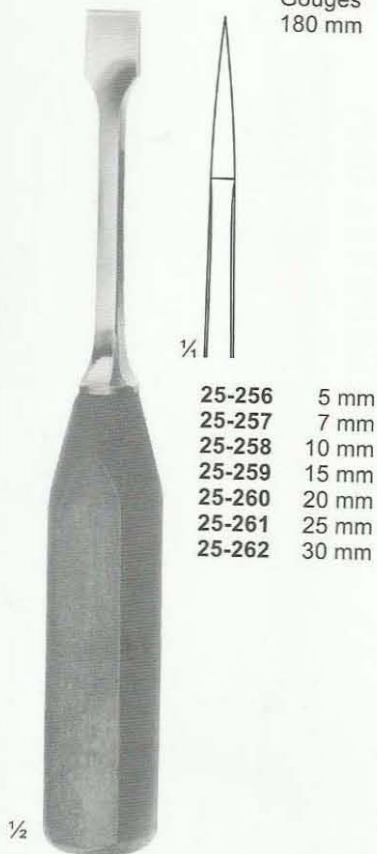

- 25-256 5 mm
- 25-257 7 mm
- 25-258 10 mm
- 25-259 15 mm
- 25-260 20 mm
- 25-261 25 mm
- 25-262 30 mm

LEXER
25-256 - 262
Osteotomes
220 mm

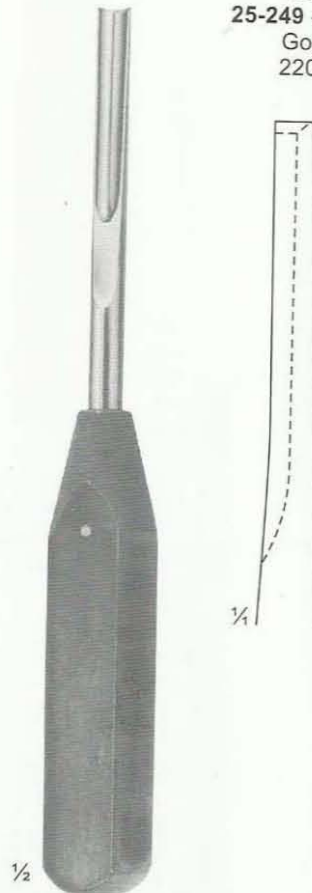

25-263 9mm
Gouge for
removing broken
screws

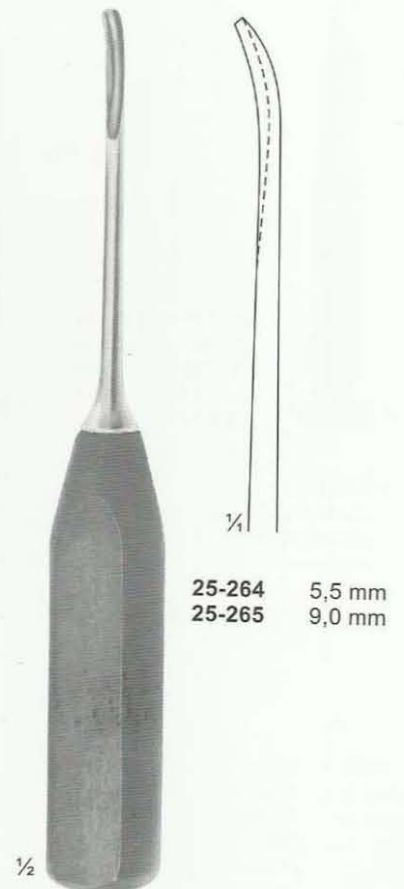

- 25-264 5,5 mm
- 25-265 9,0 mm

ZIELKE
25-264 - 265
Gouges for
scoliosis operations

Can be sterilized in a
stream sterilizer upto
3 bar over pressure
(143 C).

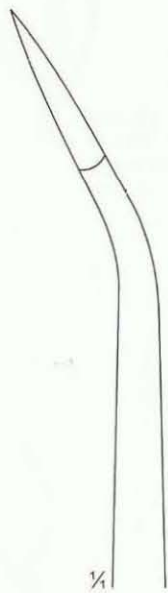

25-266 10 mm
25-267 15 mm



25-268 10 mm
25-269 15 mm



25-270 20mm
Chisel
245 mm



25-271 16mm
Chisel, curved
265 mm

LEXER
25-266 - 267
Osteotomes,
angled
275 mm

LEXER
25-268 - 269
Gouges,
angled
275 mm

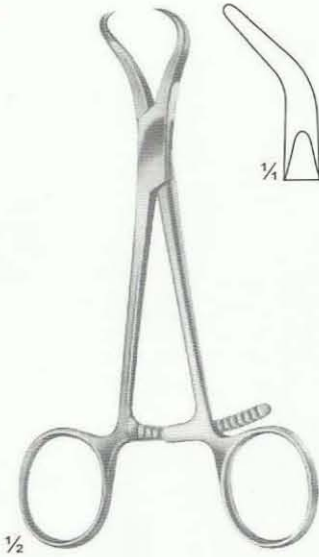

1/2

26-101
Reposition forceps,
for small fragments
135 mm



1/2

26-102
HAASE
Reposition forceps,
for mandibular
fractures
165 mm

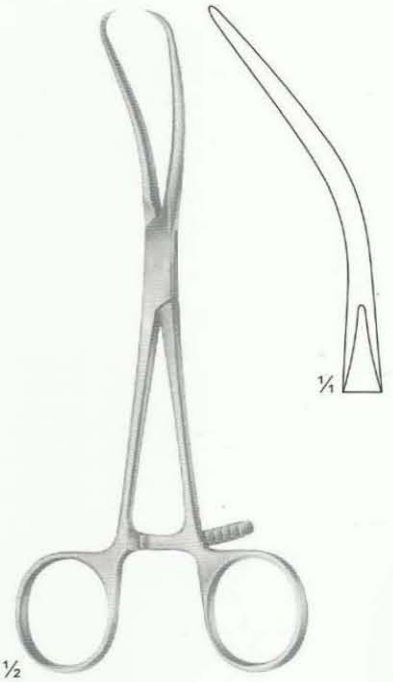

1/2

26-103
REILL
Reposition forceps,
170 mm



1/2

26-104
Reposition forceps
205 mm

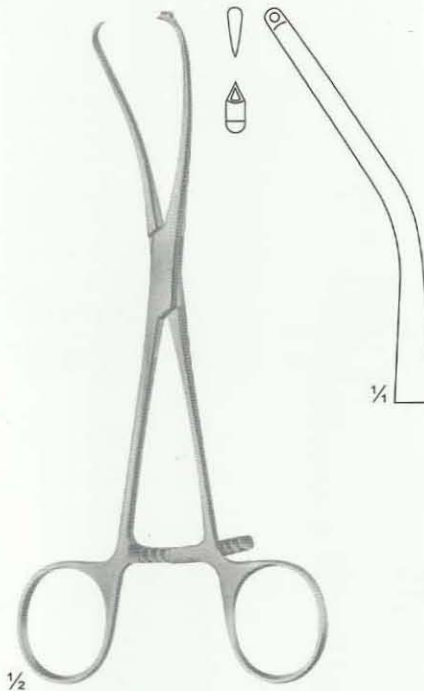

1/2

26-105
MEYER
Reposition forceps
for fingers, with drill
guide for **KIRSCHNER**
wires up to diam. 1.0 mm
170 mm



26-106
Patella forceps
185 mm



26-107
Forceps with
ratchet fixation
140 mm



26-108
Forceps with
thread fixation
170 mm



26-109
Forceps with
thread fixation
235 mm

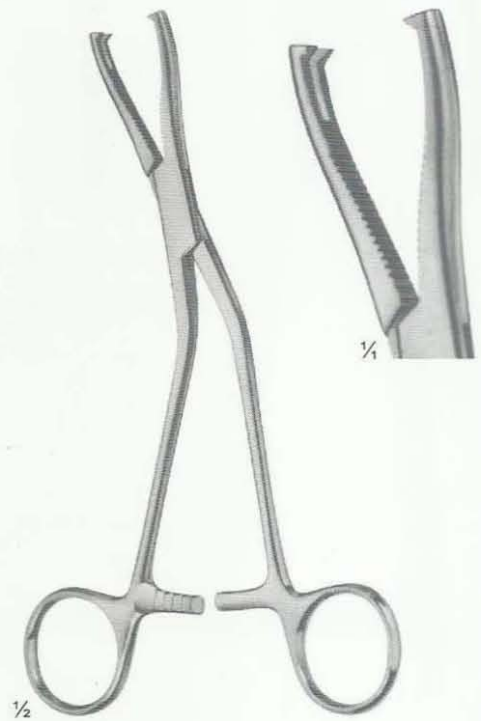

26-110
DINGMANN modif
185 mm



26-111
Sequestrum
forceps
200 mm

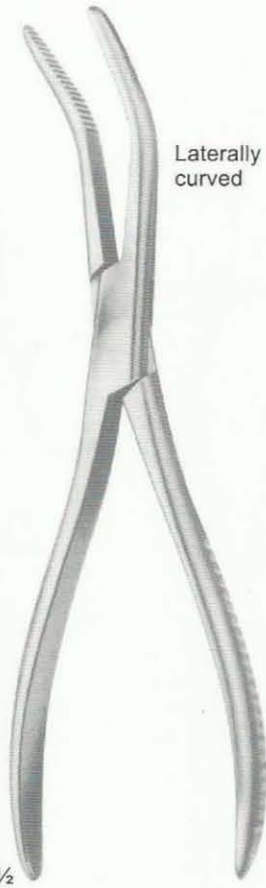

26-112
VAN BUREN
Sequestrum
forceps
225 mm

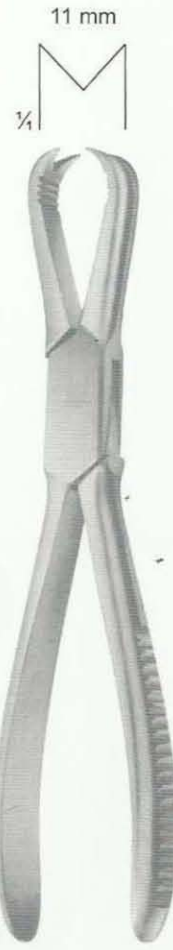

26-113
LANGENBECK
205 mm

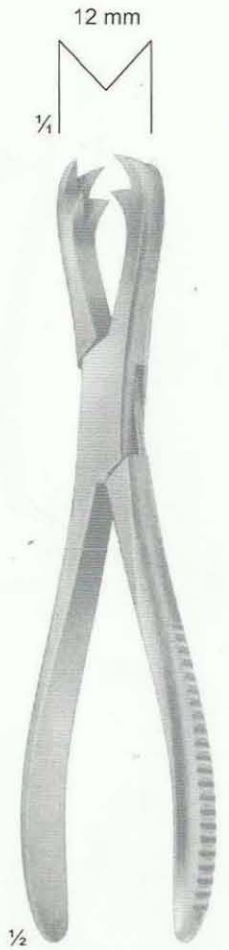

26-114
FERGUSON
205 mm

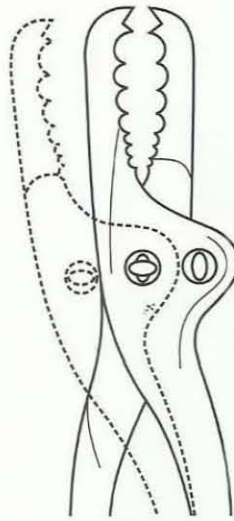
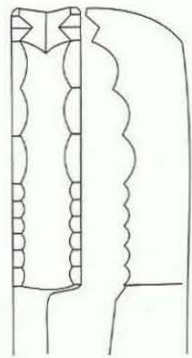

jaw adjustable

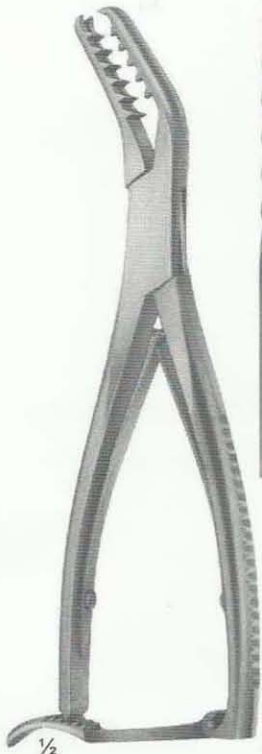
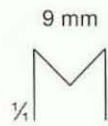
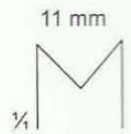
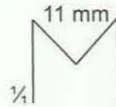
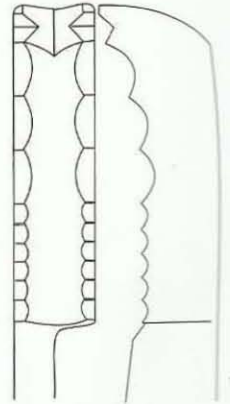

26-115
SEMB
190 mm

FARABEUF
26-116 19 cm
26-116A 23 cm

26-117
FARABEUF
255 mm

FARABEUF-LAMBOTTE
26-118 19 cm
26-118A 23 cm



26-119
KERN-LANE
240 mm

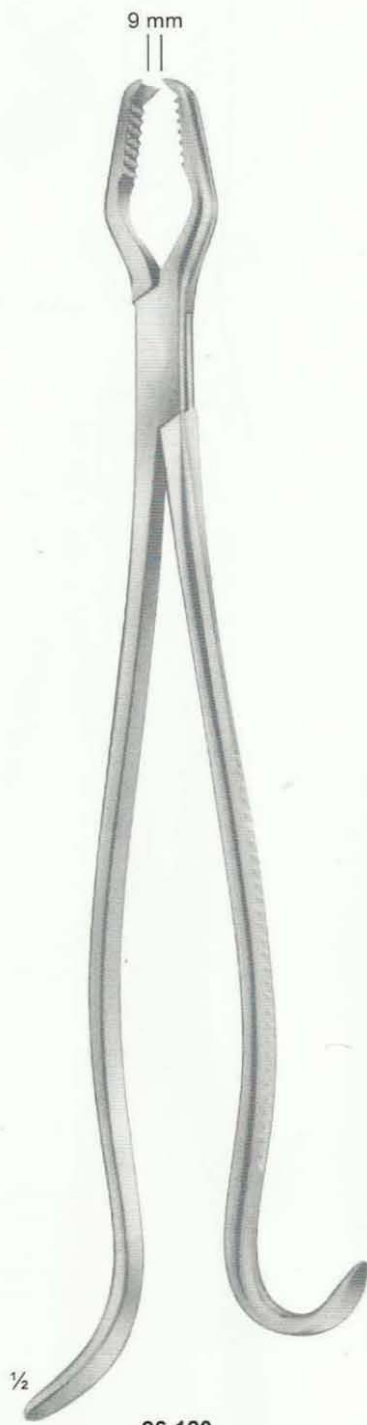

26-120
LANE
330 mm



26-121
KERN-LANE
240 mm

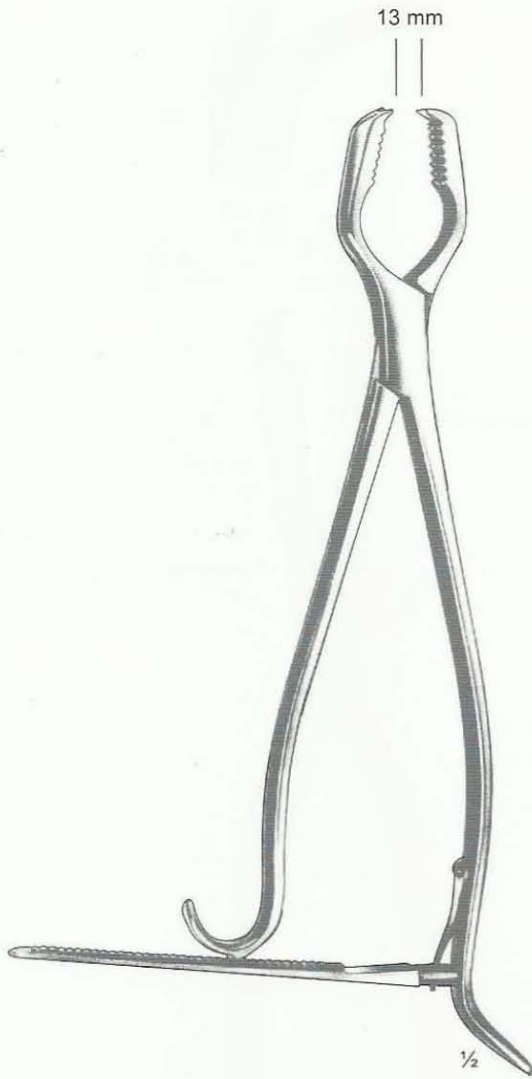
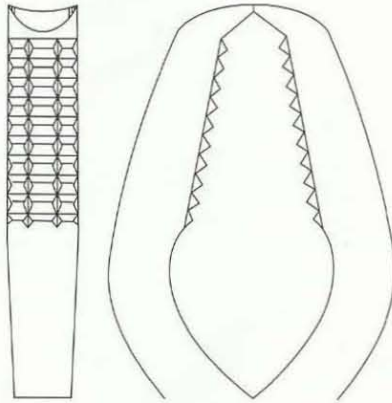

LANE
26-122
 30 cm
26-122A
 32.5 cm
 Bone holding forceps
 Standard model, without ratchet
26-122B
 32.5 cm
 Standard model, with ratchet
26-122C
 42.5 cm
 With ratchet

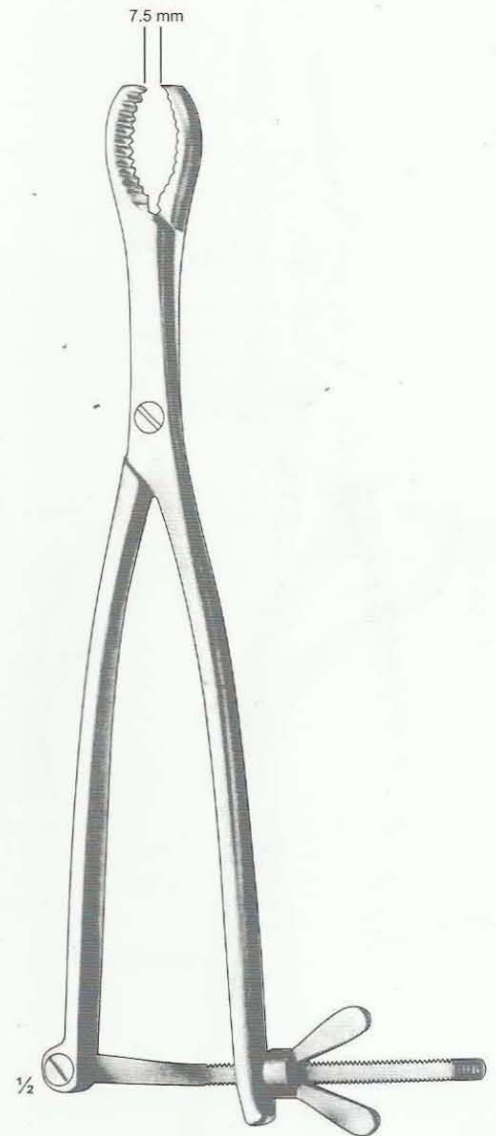

HEY GROVES
26-123
 42.5 cm
 With ratchet
26-123A
 25 cm
26-123B
 30.5 cm



26-124 - 128

- 26-124 145 mm
- 26-125 190 mm
- 26-126 240 mm
- 26-127 260 mm
- 26-128 280 mm

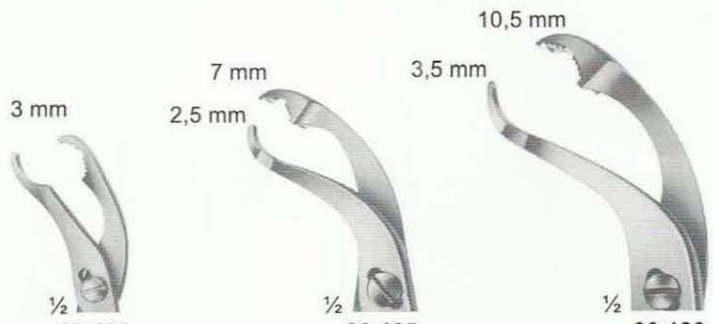

26-124
for small
fragments

26-125
Fig: 0

26-126
Fig: 1

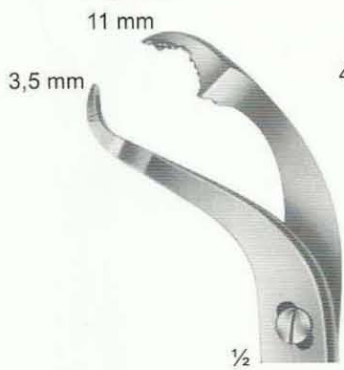

26-127
Fig: 2

26-128
Fig: 3

Self-centering forceps
with thread fixation

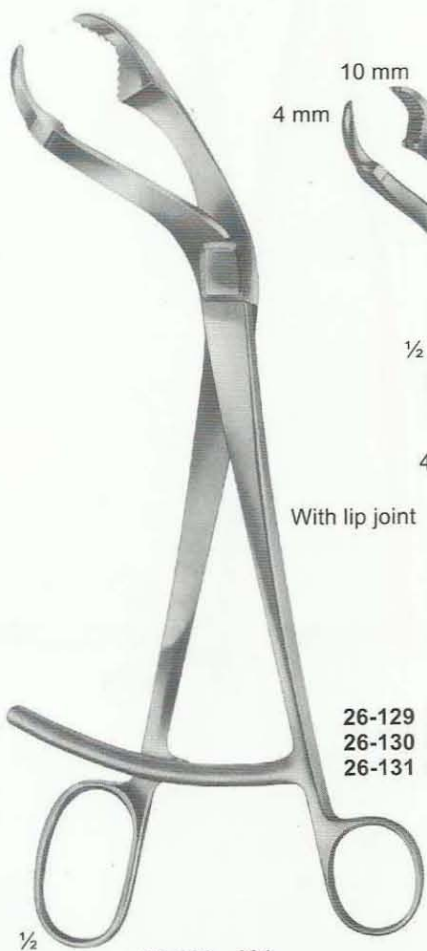

26-129 - 131
VERBODIGE

- 26-129 255 mm
- 26-130 265 mm
- 26-131 270 mm

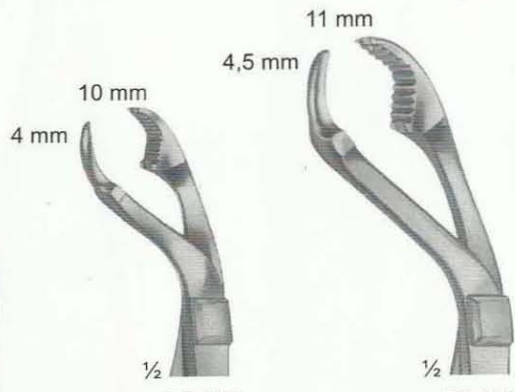

26-129
Fig: 1

26-130
Fig: 2



26-131
Fig: 3



26-132
LAMBOTTE
265 mm

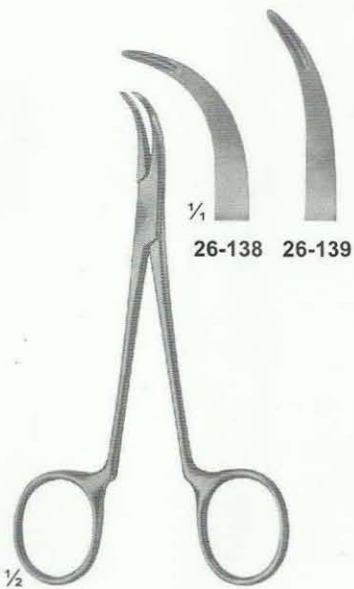

26-138 - 139
Synovectomy rongeur
width of jaws 1.2 mm
130 mm

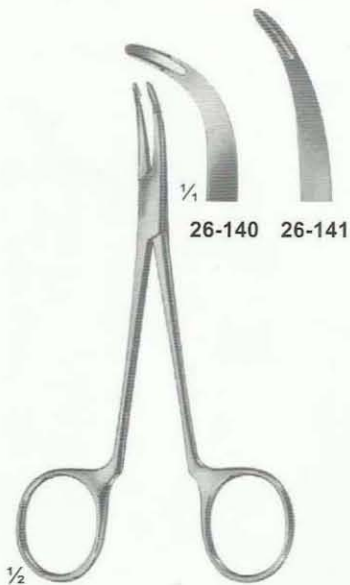

26-140 - 141
Synovectomy rongeur
width of jaws 2.0 mm
130 mm

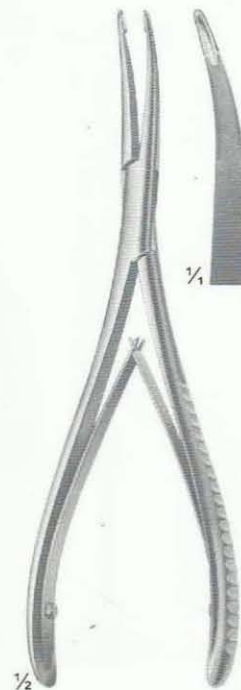

26-142
STELLBRINK
Synovectomy rongeur
175 mm

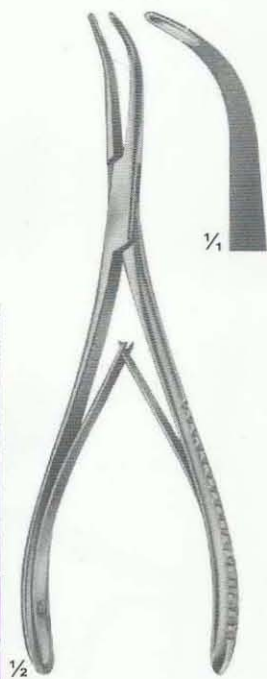

26-143
STELLBRINK
Synovectomy rongeur
170 mm



26-144
LUER-FRIEDMANN
145 mm

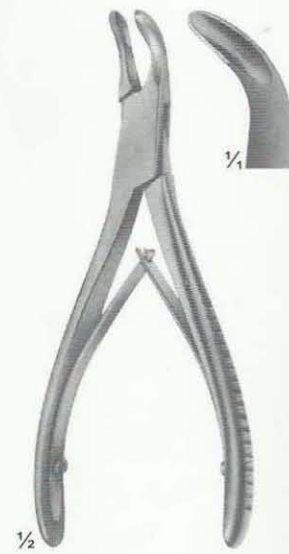

26-145
140 mm



26-146
LUER
150 mm

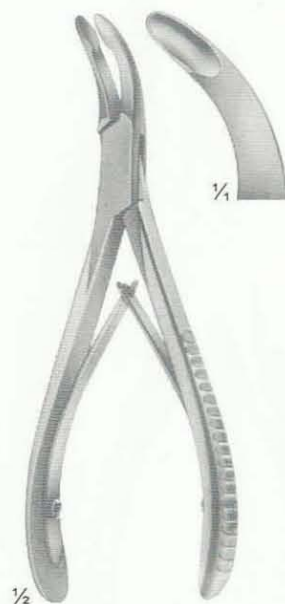

26-147
LUER
155 mm

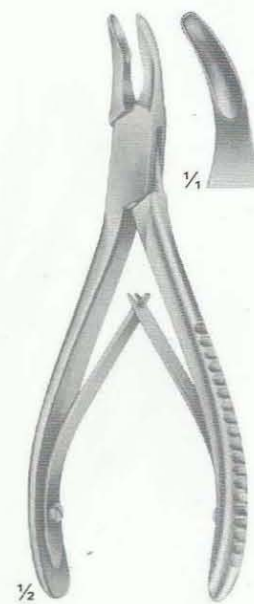

26-148
BLUMENTHAL
155 mm

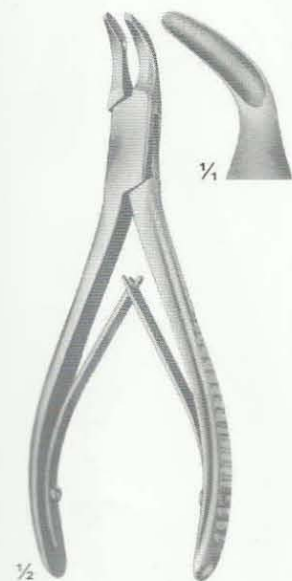

26-149
BLUMENTHAL
150 mm

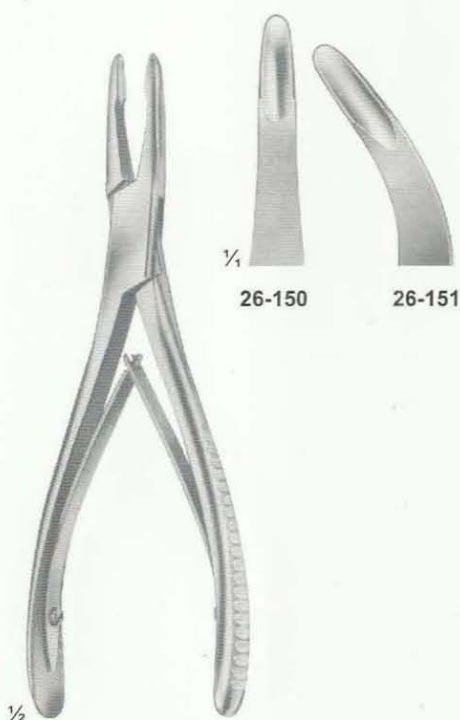

26-150 - 151
JANSEN
175 mm

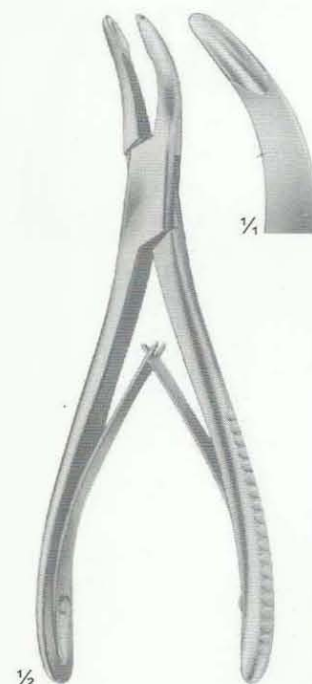

26-152
BANE-HARTMANN
175 mm

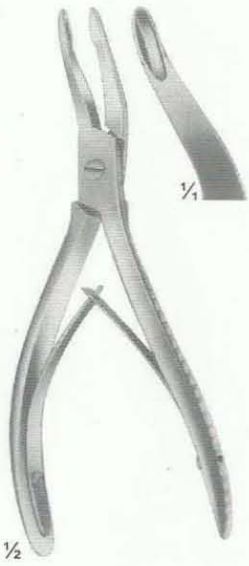

26-153
ALEXANDER
140 mm

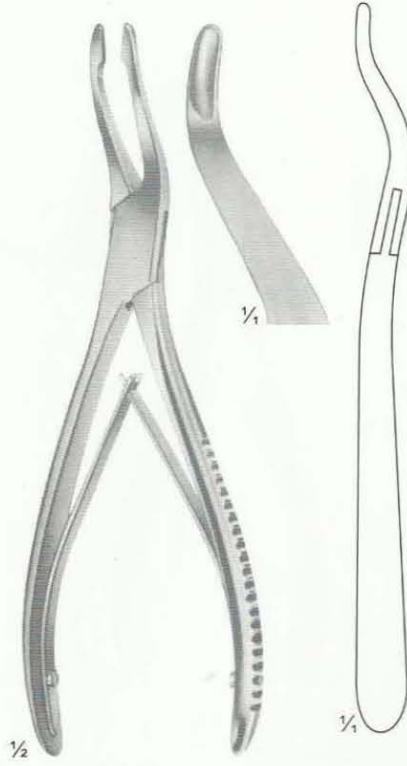

26-154
JANSEN
190 mm

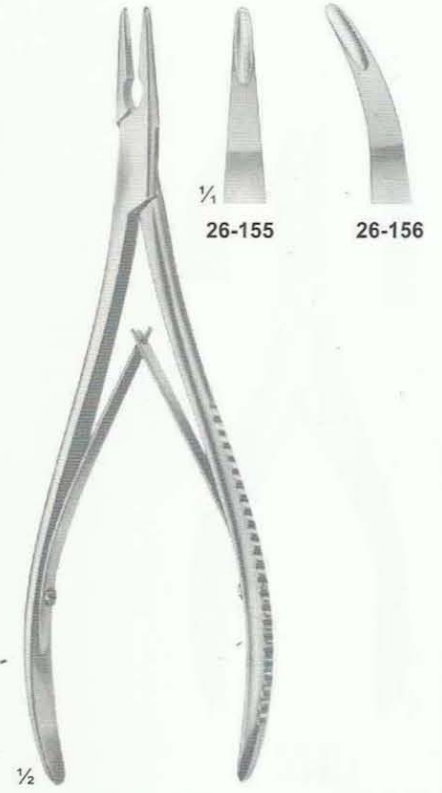

26-155 - 156
LEMPERT
200 mm

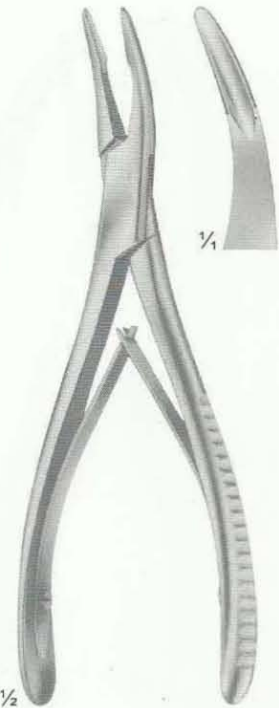

26-157
BEYER
180 mm

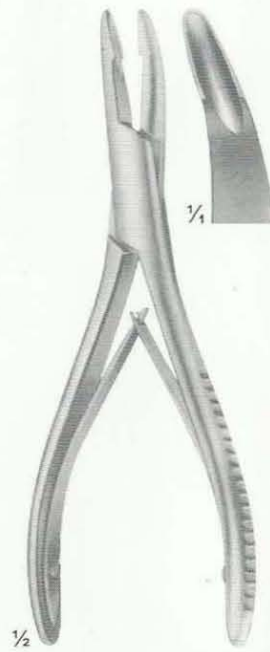

26-158
MEAD
165 mm

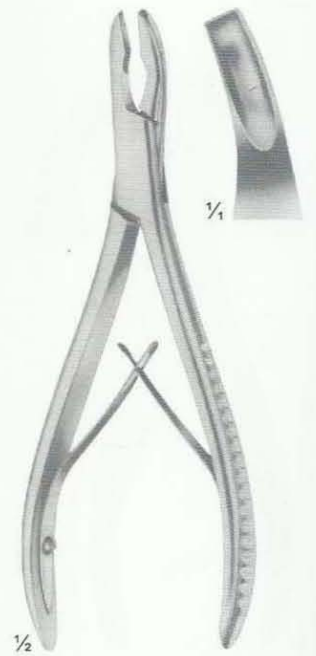

26-159
MEAD
165 mm

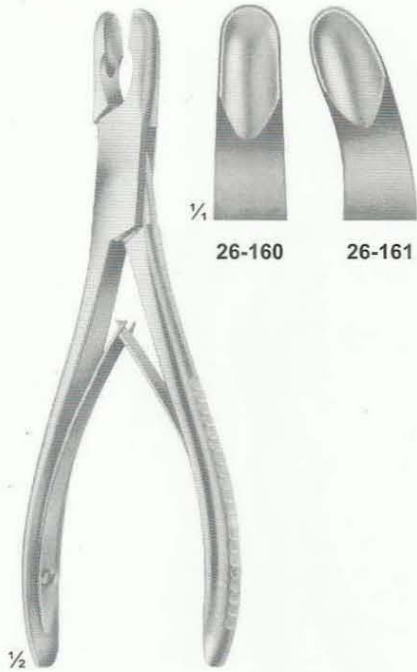

26-160 - 161
LUER
175 mm

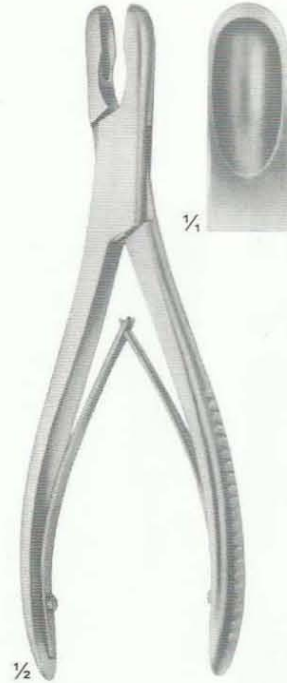

26-162
LUER
180 mm

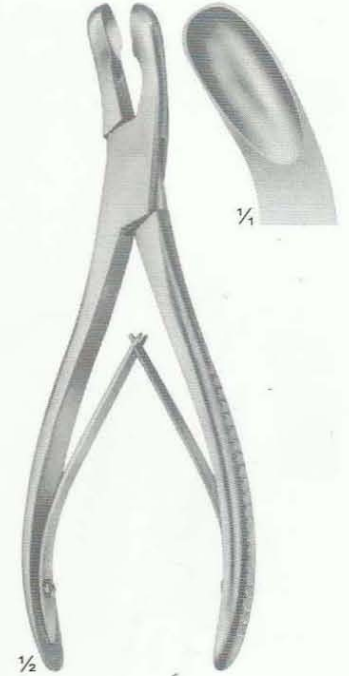

26-163
LUER
180 mm

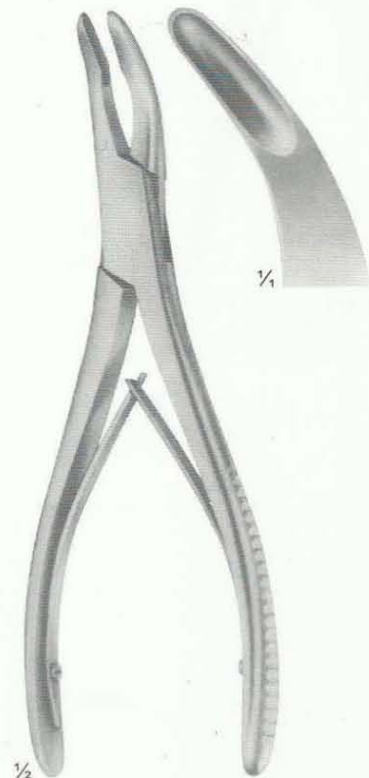

26-164
OLIVECRONA
205 mm

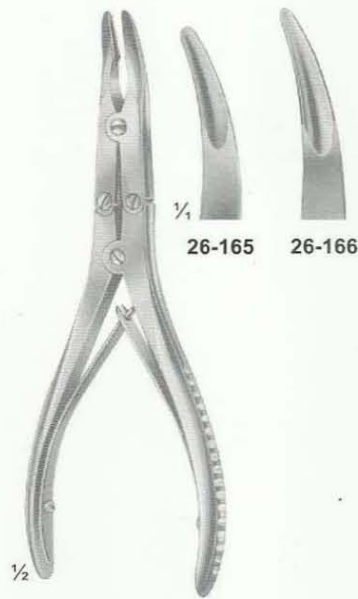

26-165 - 166
BOHLER
155 mm

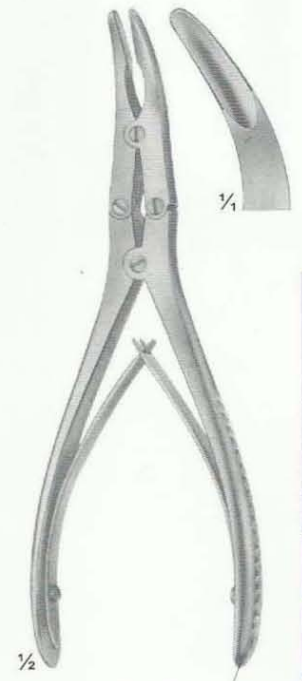

26-167
MARQUARDT
200 mm

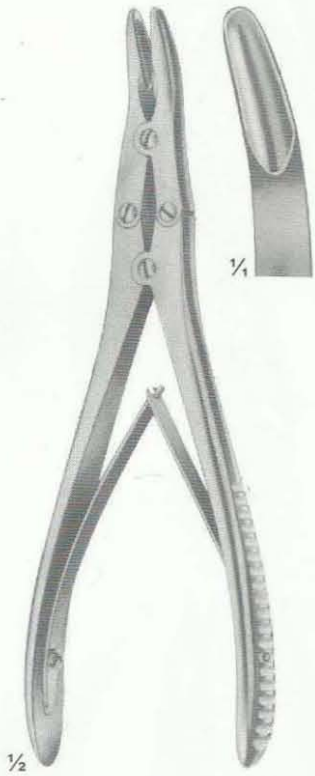

26-168
RUSKIN
190 mm



26-169
ROETTGEN-RUSKIN
240 mm

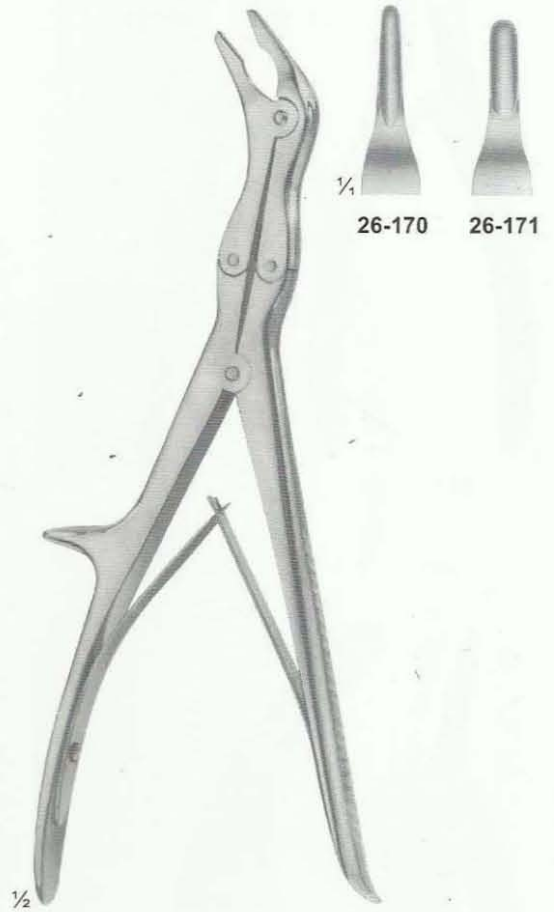

26-170 - 171
ECHLIN
230 mm



26-172
STILLE
235 mm



26-173
LEKSELL-STILLE
240mm

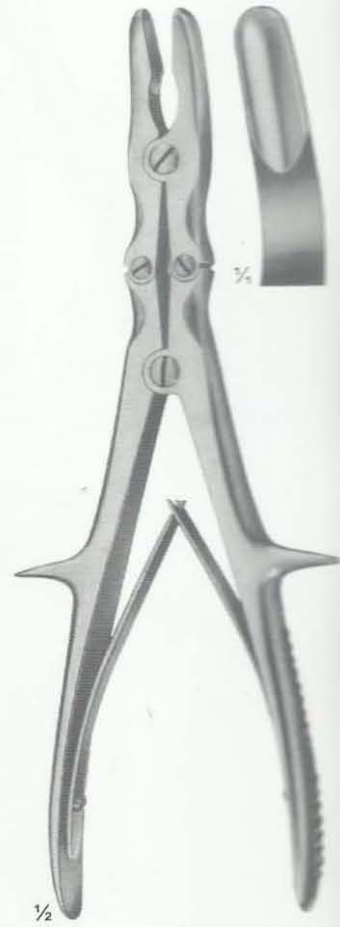

26-174
STILLE-RUSKIN
240mm

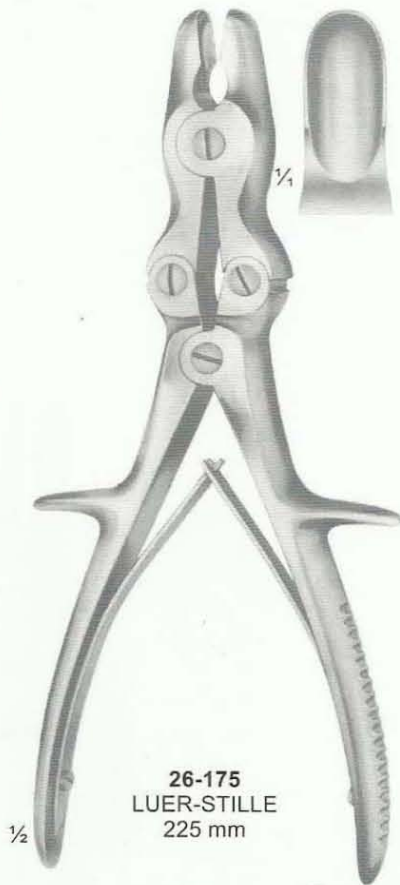

26-175
LUER-STILLE
225 mm



26-176
LUER-STILLE
225 mm

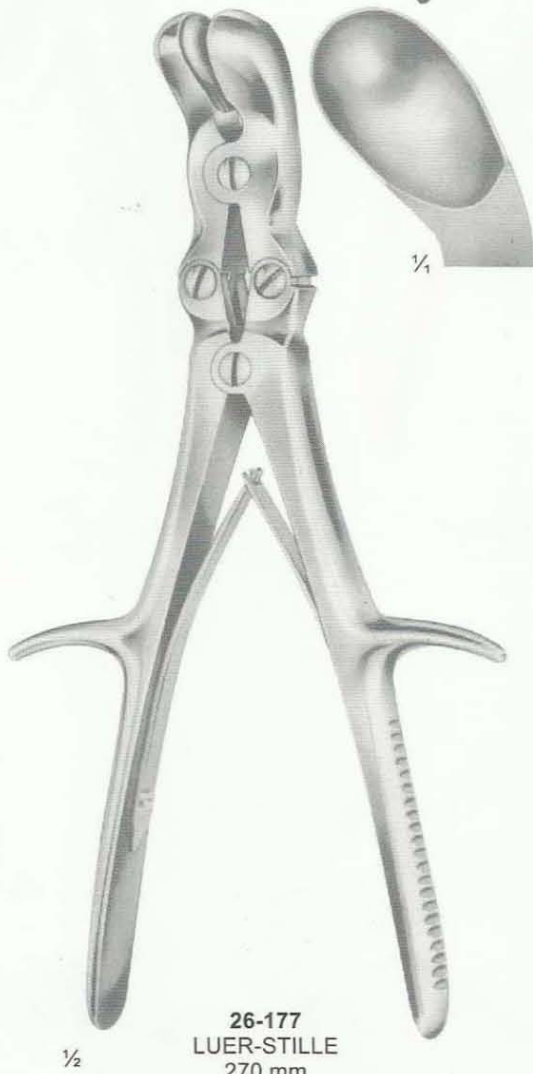

26-177
LUER-STILLE
270 mm

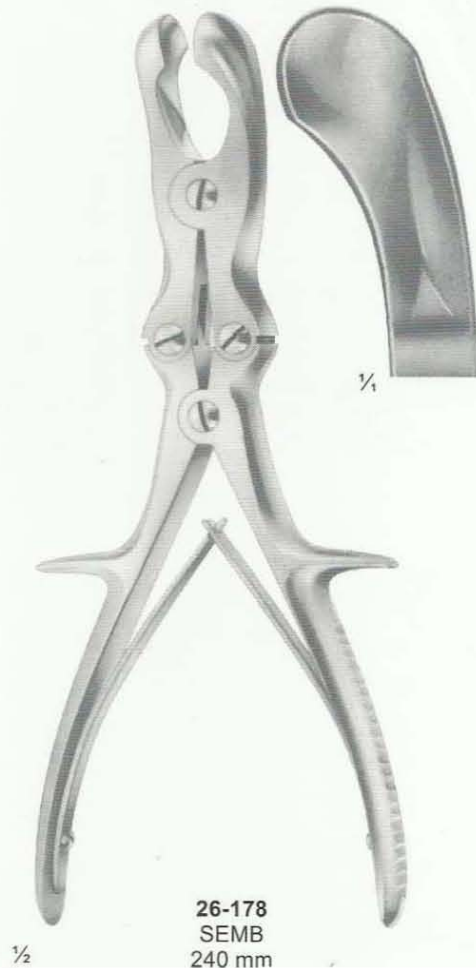

26-178
SEMB
240 mm

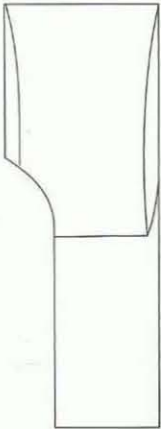

26-178A

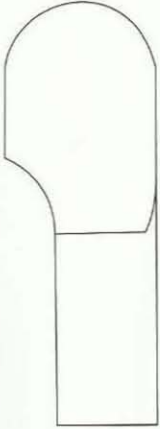

26-178B

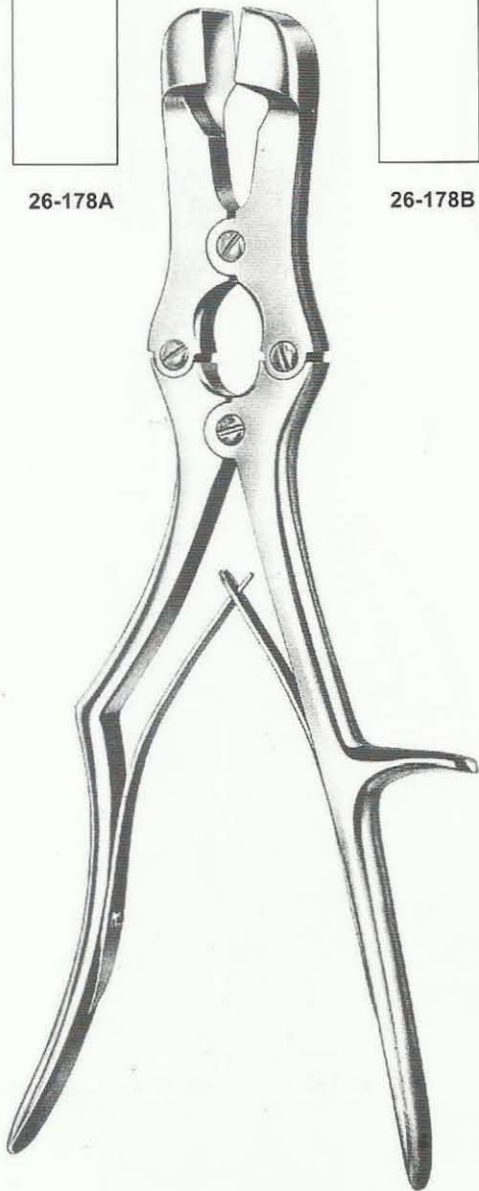

SAUERBRUCH
30 cm

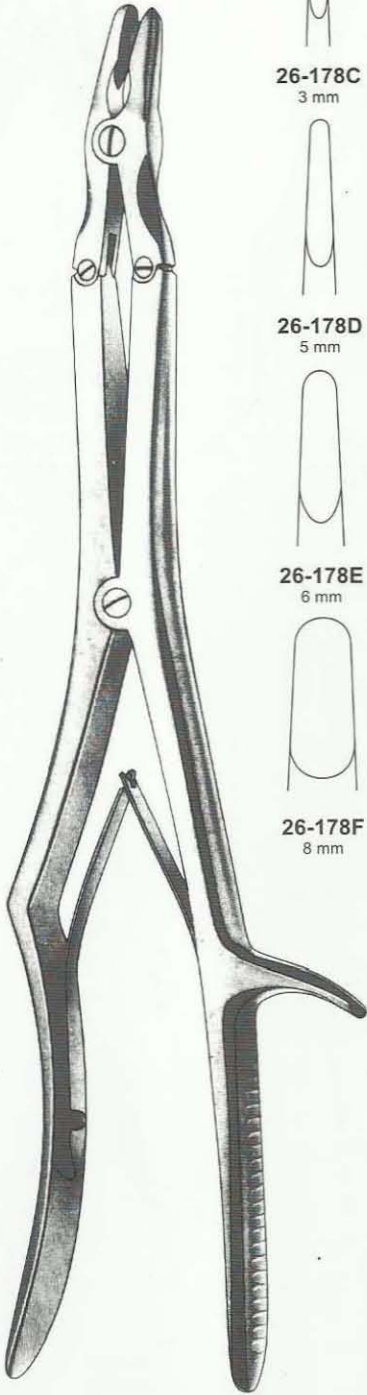

SYPERT
36 cm



26-178C
3 mm

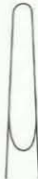

26-178D
5 mm

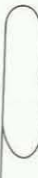

26-178E
6 mm



26-178F
8 mm

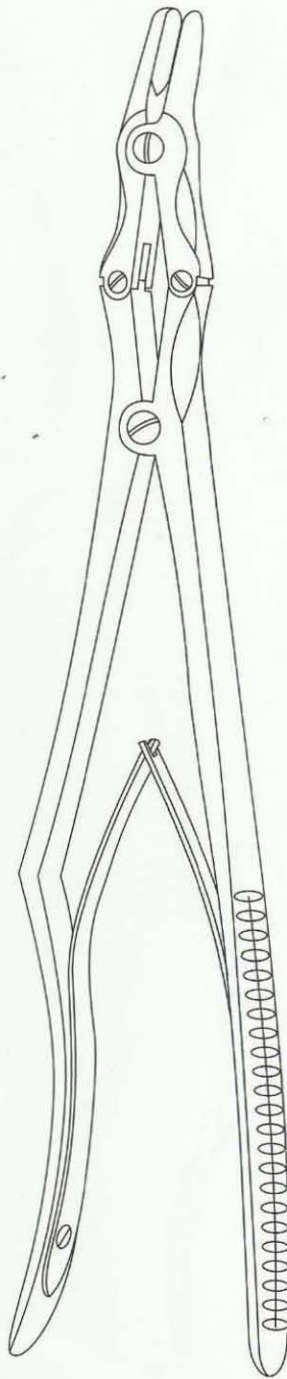

DALE



26-178G
3 mm



26-178H
5 mm



26-178J
6 mm



26-178K
8 mm

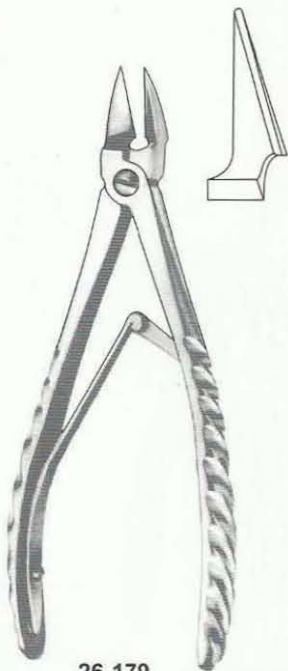

26-179
STAMM
150 mm

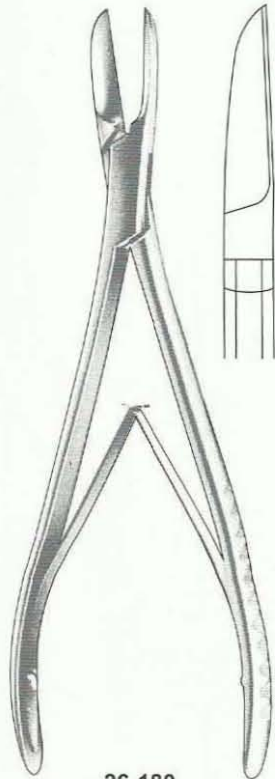

26-180
KAZANJIAN
185 mm

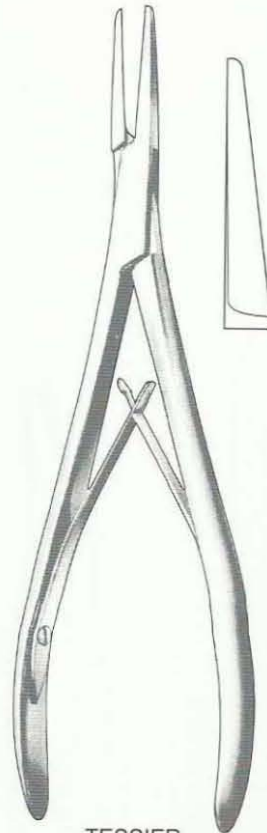

TESSIER
26-180A
20.5 cm
Slim pattern

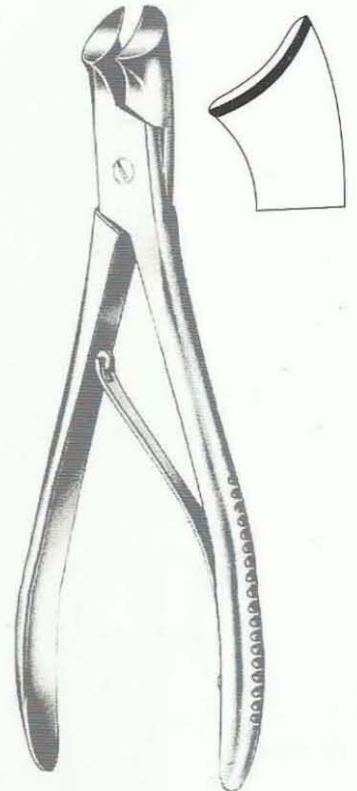

MARKWALDER
26-180B



26-181
14 cm



26-182
17 cm



26-185
14 cm



26-186
17 cm

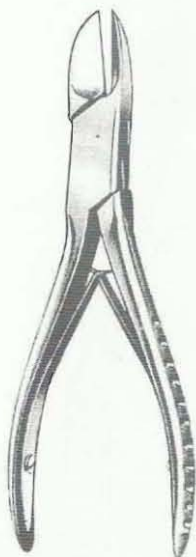

26-181 - 184
LISTON



26-183
19 cm



26-184
22 cm

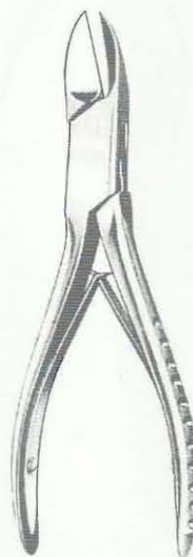

26-185 - 187
LISTON



26-187
19 cm



26-187A
22 cm

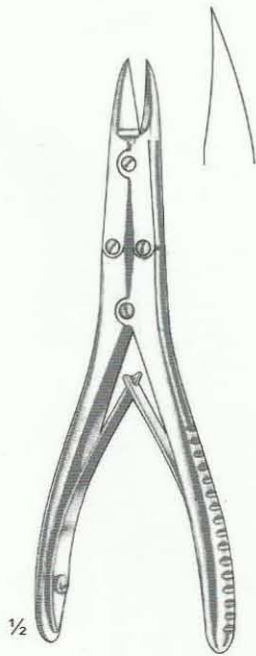

26-188
BOEHLER
145 mm

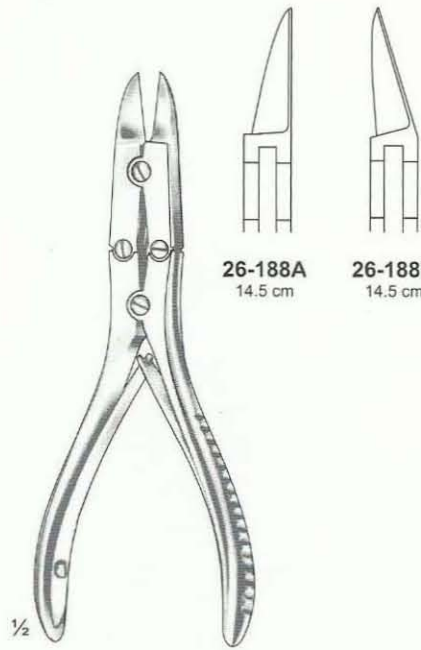

26-188A
14.5 cm

26-188B
14.5 cm

26-188A to 26-188B
BOEHLER
145 mm

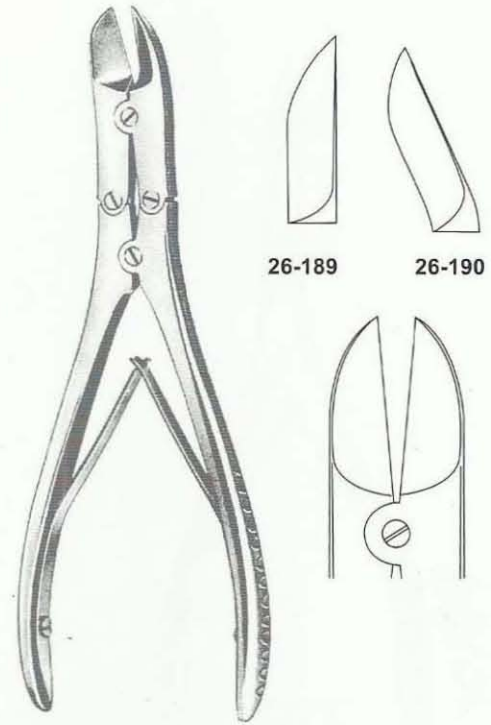

26-189

26-190

$\frac{1}{2}$ RUSKIN-LISTON
190 mm

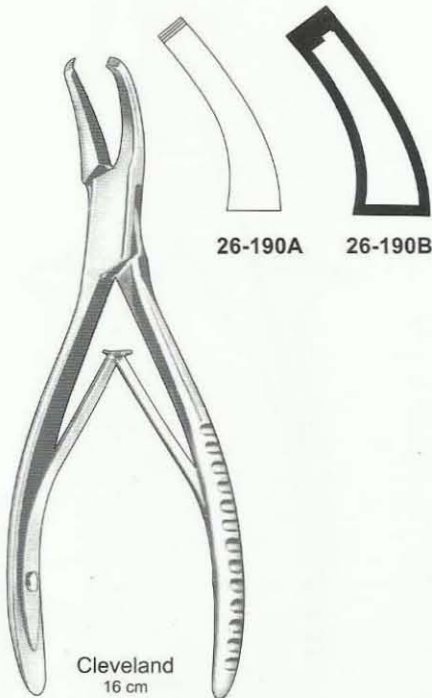

26-190A

26-190B

Cleveland
16 cm

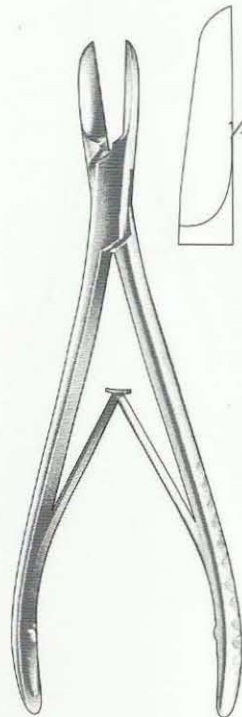

Cleveland
26-190C
15 cm

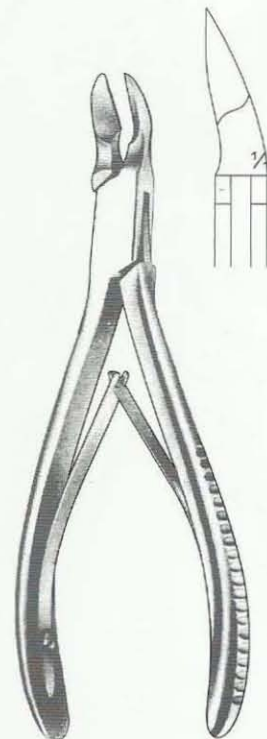

Cleveland
26-190D
17 cm
26-190E
15 cm

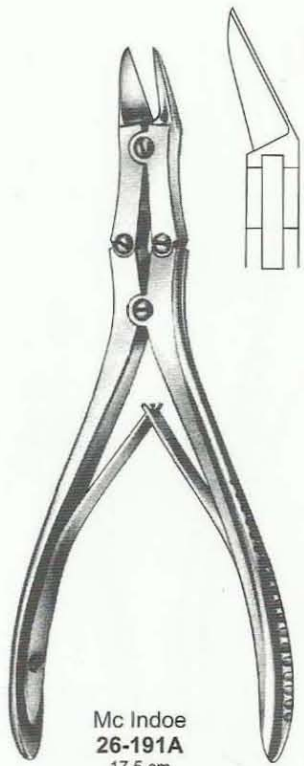

Mc Indoe
26-191A
17.5 cm

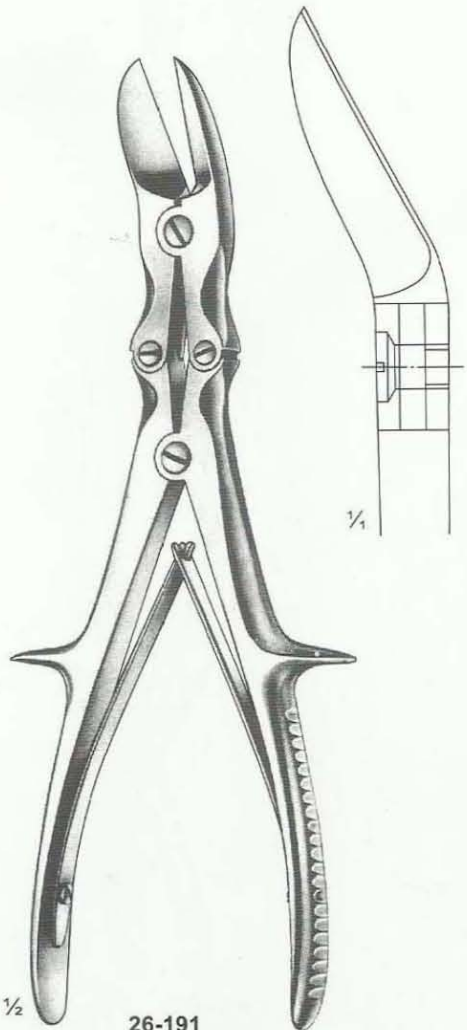
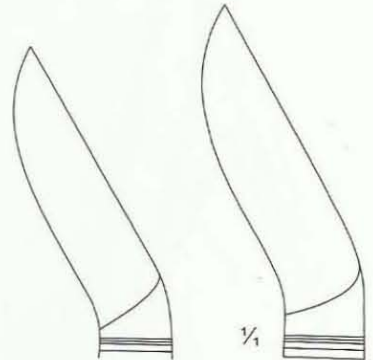
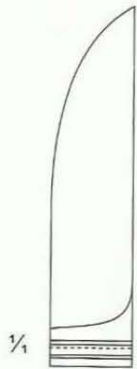

26-191
LISTON
curved on flat
240 mm

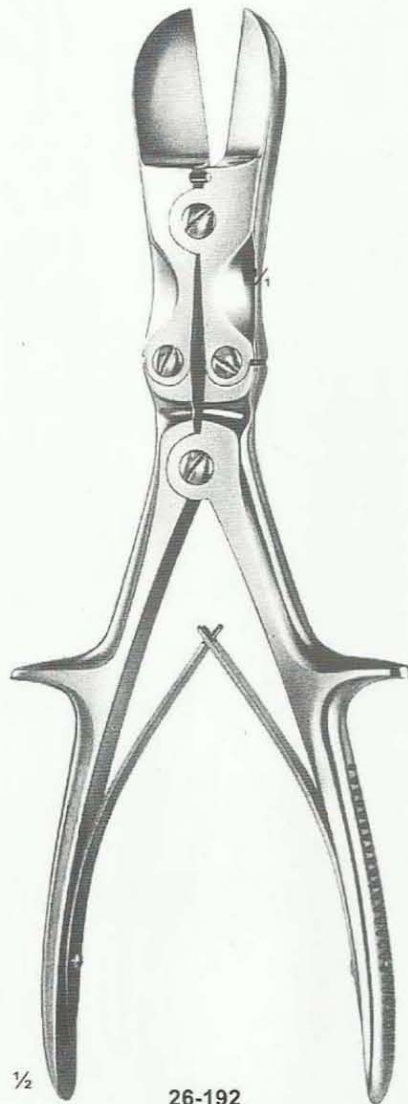

26-192
LISTON
straight
280 mm

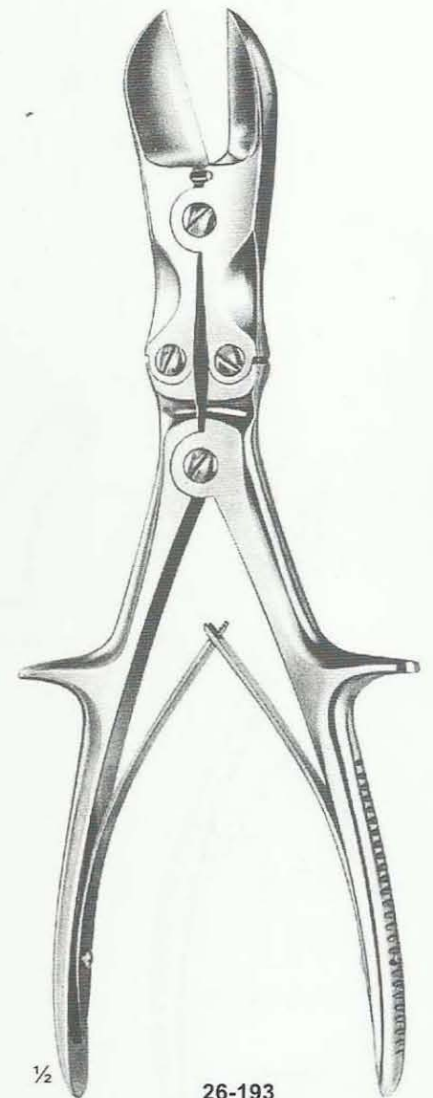

26-193
LISTON
curved on flat
280 mm

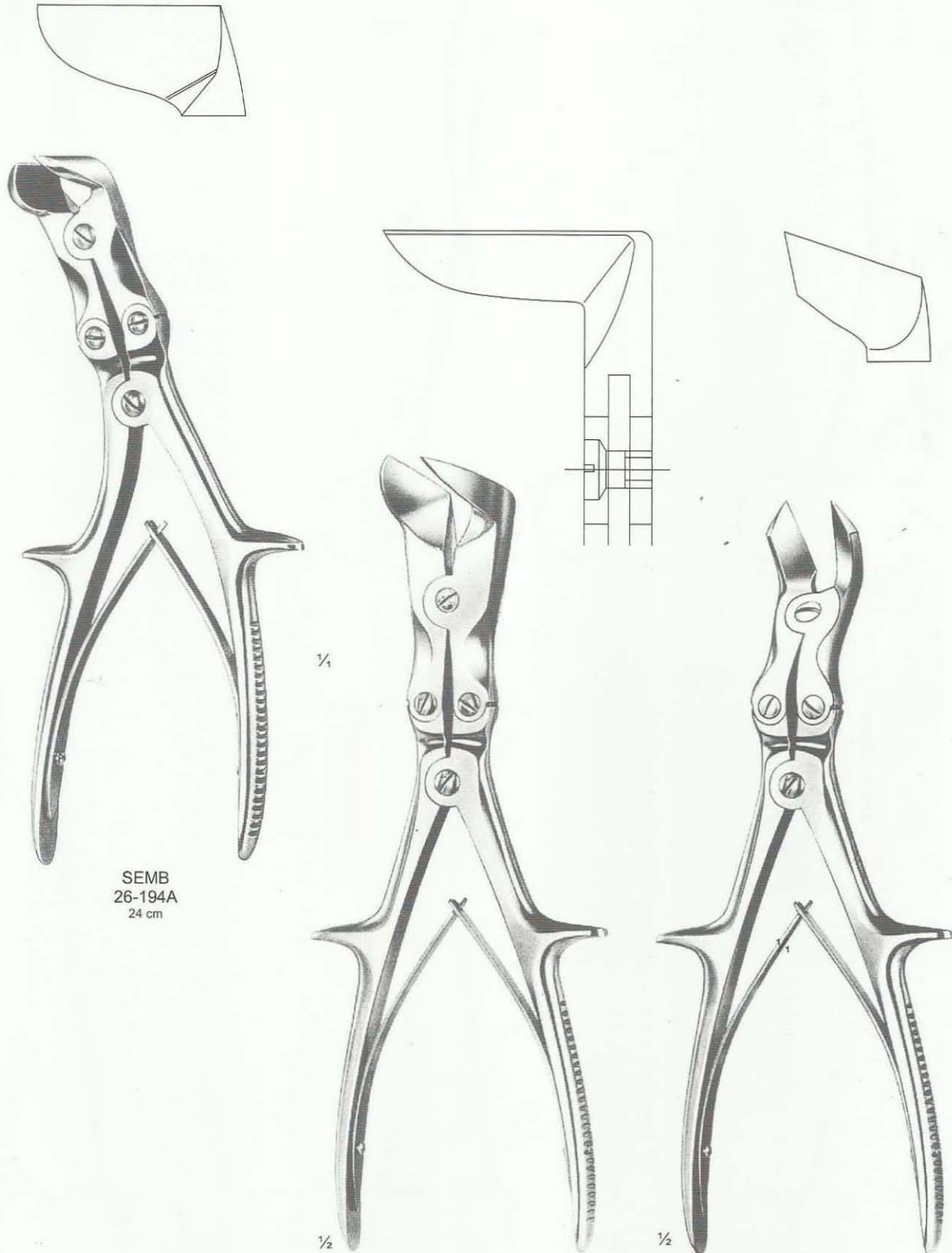

SEMB
26-194A
24 cm

1/4

1/2

26-194
LISTON-STILLE
265 mm

1/2

26-195
LISTON-KEY-HORSLEY
(TUDOR EDWARDS)
255 mm

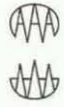
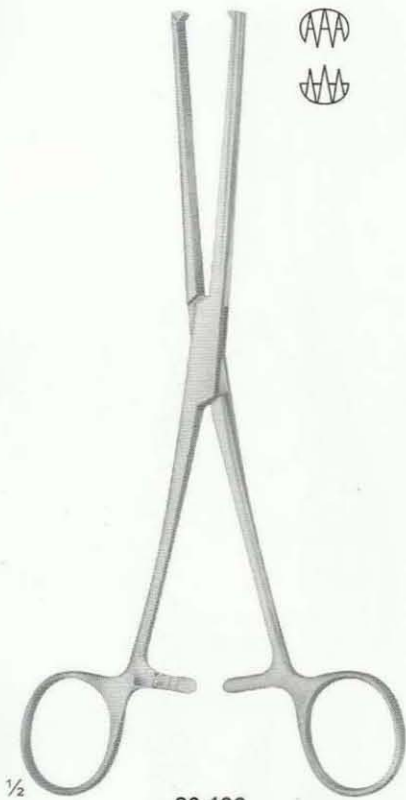

26-196
BIRCHER
200 mm



26-197
BIRCHER
200 mm



26-198
WELLER
200 mm

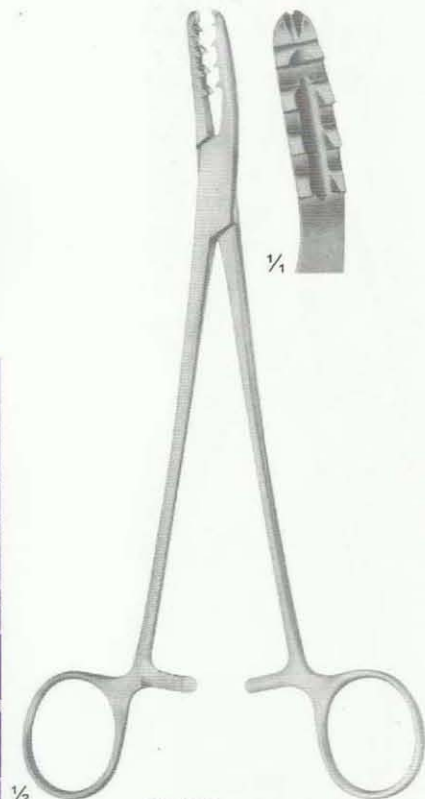

1/4

26-199
BIRCHER-GANSKE
200 mm

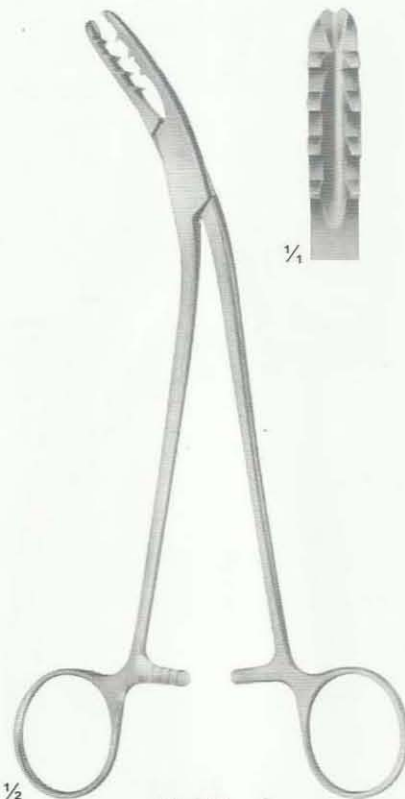

1/4

26-200
BIRCHER-GANSKE
200 mm



1/4

26-201
MARTIN
205 mm

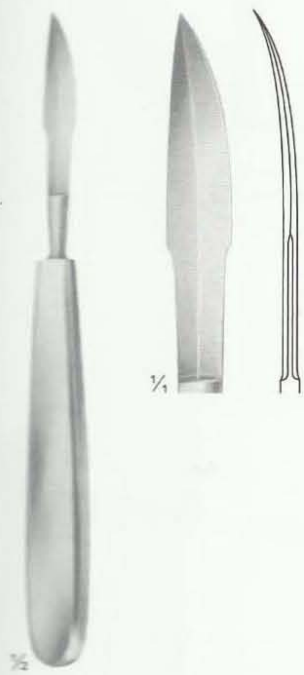

26-202
170 mm

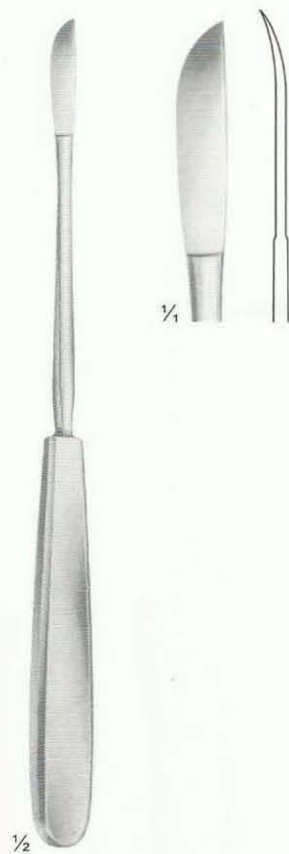

26-203
NEFF
215 mm

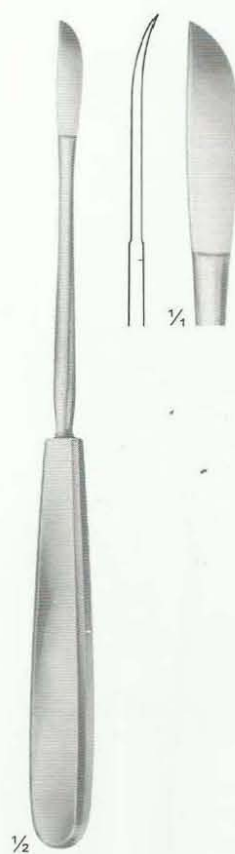

26-204
NEFF
215 mm



26-205
WAGNER
215 mm

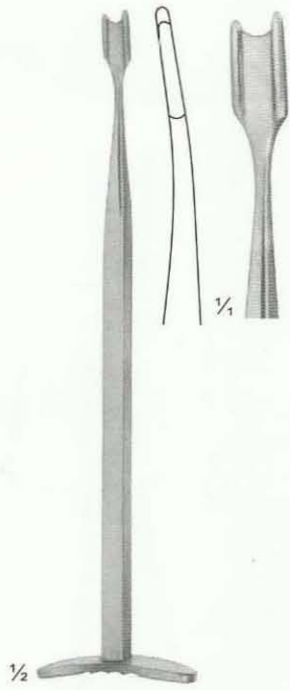

26-206
SMILLIE
170 mm

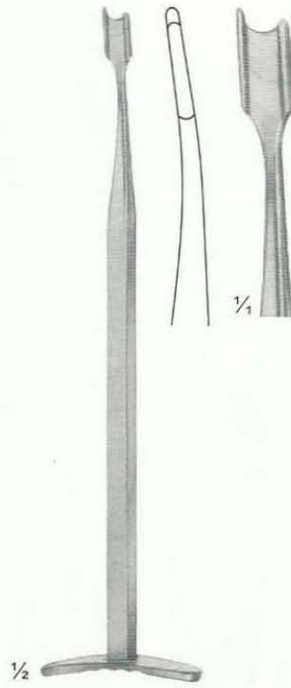

26-207
SMILLIE
170 mm

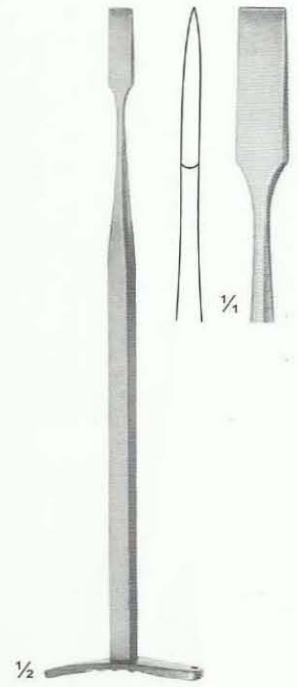

26-208
SMILLIE
170 mm

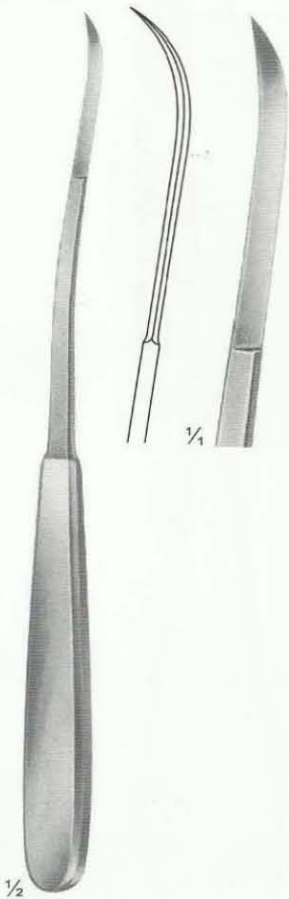

26-209
SALENIUS
220 mm

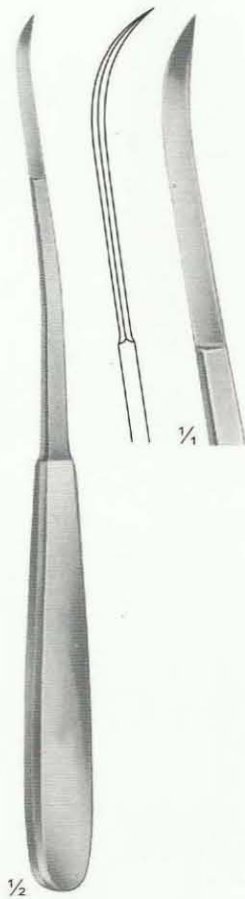

26-210
SALENIUS
220 mm

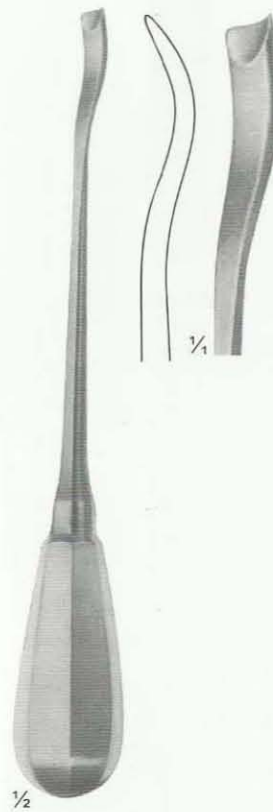

26-211
CANAD. MODELL
200 mm

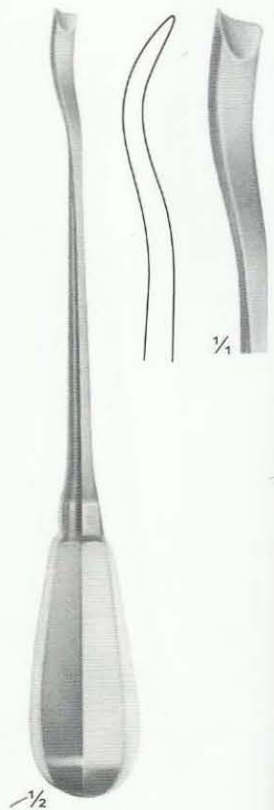

26-212
CANAD. MODELL
200 mm

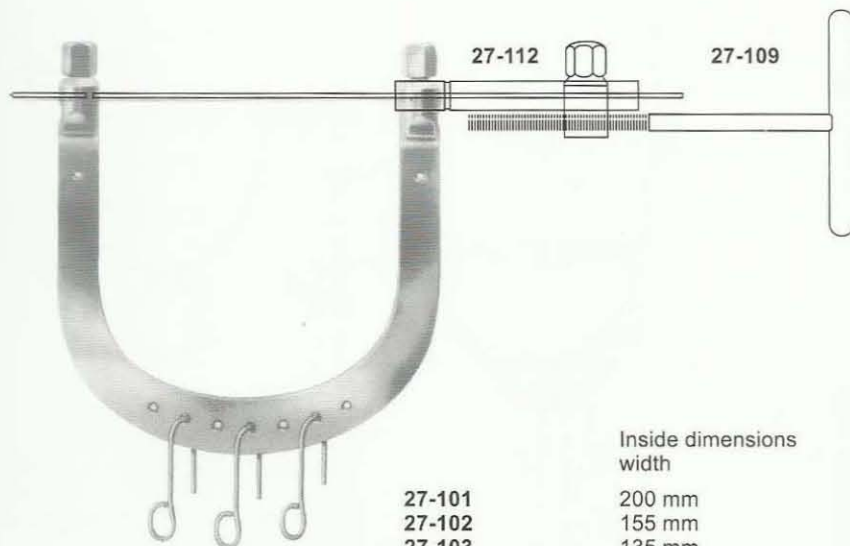

27-101 - 107
KIRSCHNER
 Wire traction bows,
 to be used with
 KIRSCHNER-wires
 up to 2.5 mm diam.,
 With 3 hooks,
 stainless steel

	Inside dimensions width	depth	
27-101	200 mm	155 mm	for the hip
27-102	155 mm	155 mm	for the femur
27-103	135 mm	130 mm	for the knee
27-104	120 mm	120 mm	for the knee
27-105	105 mm	100 mm	for the knee
27-106	95 mm	110 mm	for the calcaneus
27-107	95 mm	70 mm	for the arm and elbow



27-108
 Wrench, double - ended,
 for wire traction bows 27-101 - 27-115



27-109
 Wire tightener, with
 clamping jaws



27-110
 Traction hook only,
 large size



27-111
 Traction hook only,
 small size



Kuntscher
 26 cm
27-111A 8 mm
27-111B 10 mm
27-111C 12.5 mm



Kuntscher
27-111D
 35 cm



27-112
 Fixation clamp, to secure clamping
 jaws of 27-109 stainless steel

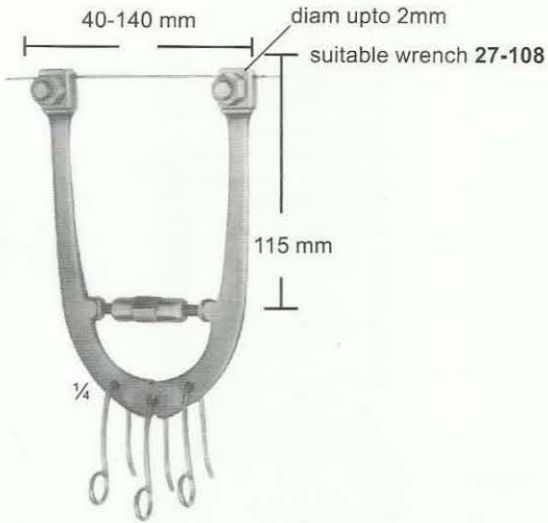

27-113
Wire traction bow, adjustable,
with 3 hooks, small size

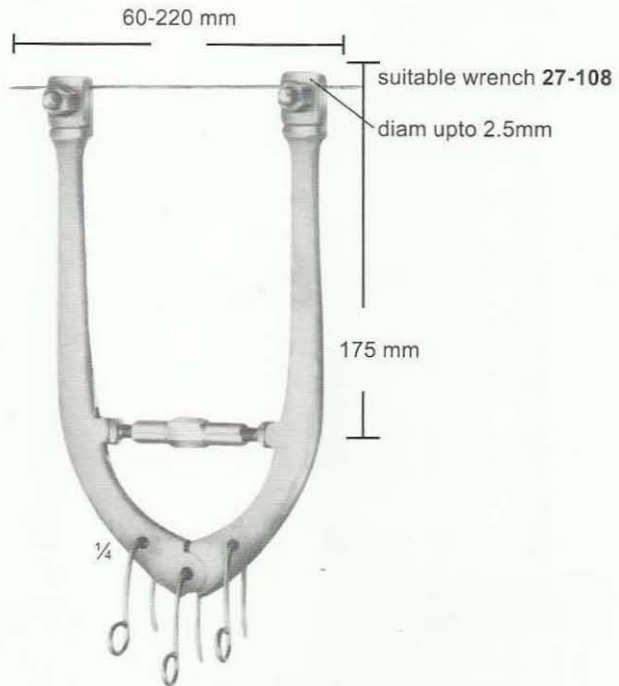

27-114
Wire traction bow, adjustable,
with 3 hooks, large size

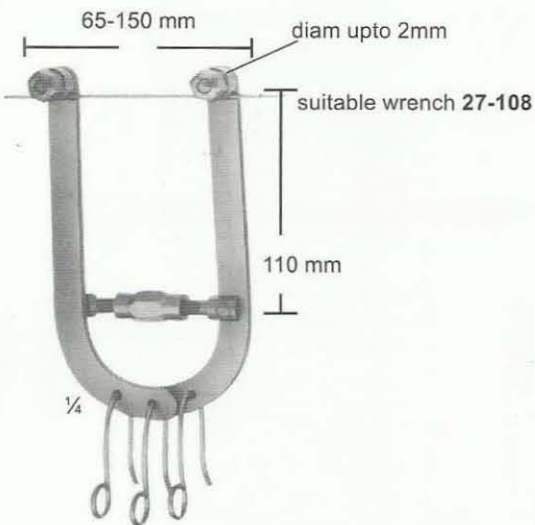

27-115
Wire traction bow, adjustable,
with 3 hooks, small size for
elbow and calcaneus, for
adolescents

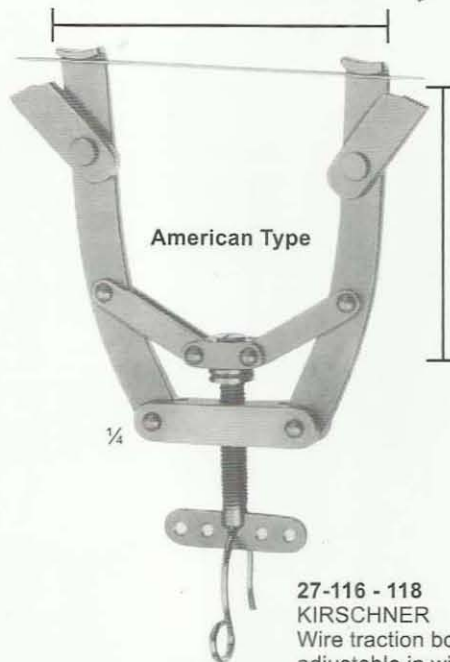

27-116	max. 105 mm
27-117	max. 160 mm
27-118	max. 200 mm
27-116	80-95 mm
27-117	90-120 mm
27-118	140-170 mm
diam upto	
27-116	1,6 mm
27-117	2,0 mm
27-118	2,5 mm

27-116 - 118
KIRSCHNER
Wire traction bows, modified,
adjustable in width, holds wire
securely, with 1 hook

27-119
Fixation disc, slotted



27-120
idem, aluminum, transparent
to X-rays



27-121
Fixation disc, slotted



27-122
Screw driver, for above
fixations discs



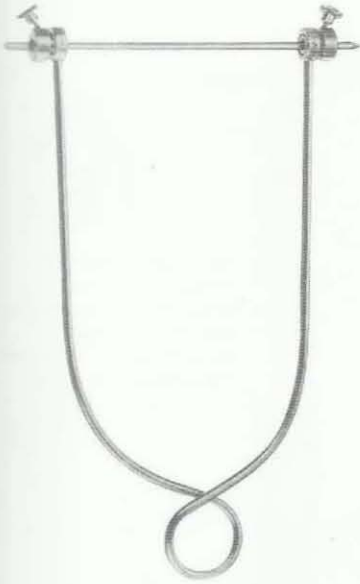

Boehler traction bows, to be used with STEINMANN pins, 4mm diam	Boehler traction bows, to be used with STEINMANN pins, 5mm diam	Inside width	For
27-123 with pin (27-135)		16x9cm	Arm
27-124 without pin	27-129 without pin		
27-125 with pin (27-137)		21x11cm	Femur and knee
27-126 without pin	27-130 without pin		
27-127 with pin (27-139)		21x15cm	Femur and knee
27-128 without pin			



27-131 - 145
STEINMANN
triangular shaft ended and trocar point

diam ϕ	4,0 mm	5,0 mm
Length		
80 mm	27-131	
100 mm	27-132	
120 mm	27-133	
140 mm	27-134	
150 mm	27-135	27-141
160 mm	27-136	
180 mm	27-137	27-142
200 mm	27-138	27-143
210 mm	27-139	
250 mm	27-140	27-144
300 mm		27-145



27-146
SCHWARZ
Traction bow for fingers,
to be used with KIRSCHNER-
wire up to 1.6 mm diam.

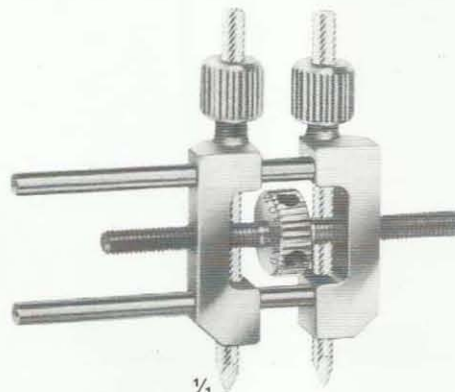

27-147
Small distractor
as a repositioning device for
distraction and compression of small bones,
for wires with 3.0 mm diam.



27-148
Protection cap
for 4,0 mm STEINMANN Pins



27-149
Protection cap
for 5,0 mm STEINMANN Pins



1/2

27-150
REILL
Drilling chuck, cannulated, for shanks from 2.0 - 2.5 mm diam 115 mm



1/2

27-151
Drilling chuck, cannulated, for shanks from 0.8 - 2.0 mm diam 150 mm



1/2

27-152
Drilling chuck, cannulated, for shanks up to 4.5 mm diam with key (27-156) 140 mm



1/2

Movable tip made of (material used for implants). While twisting the movable head remains stable, therefore the wire will not slip off.

27-153
LOUTE
Wire tightener, improved pattern, with movable tip, for wires up to 1.0 mm diam. 220 mm

Chuck jaws made of material used for implants

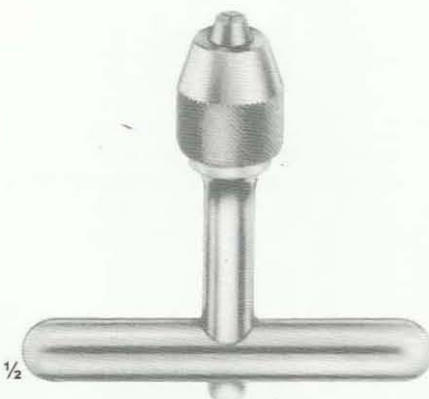

1/2

27-154
Drilling chuck, cannulated, for shanks up to 6.35 mm diam., To be tightened by hand



1/2

27-155
Drilling chuck, cannulated, for shanks up to 4.5 mm diam., And for triangular shaft width across flats 4.7 mm (schanz screws)



1/2

27-157
Drilling chuck, cannulated, for shanks up to 6.35 mm diam., With key (27-158) 160 mm

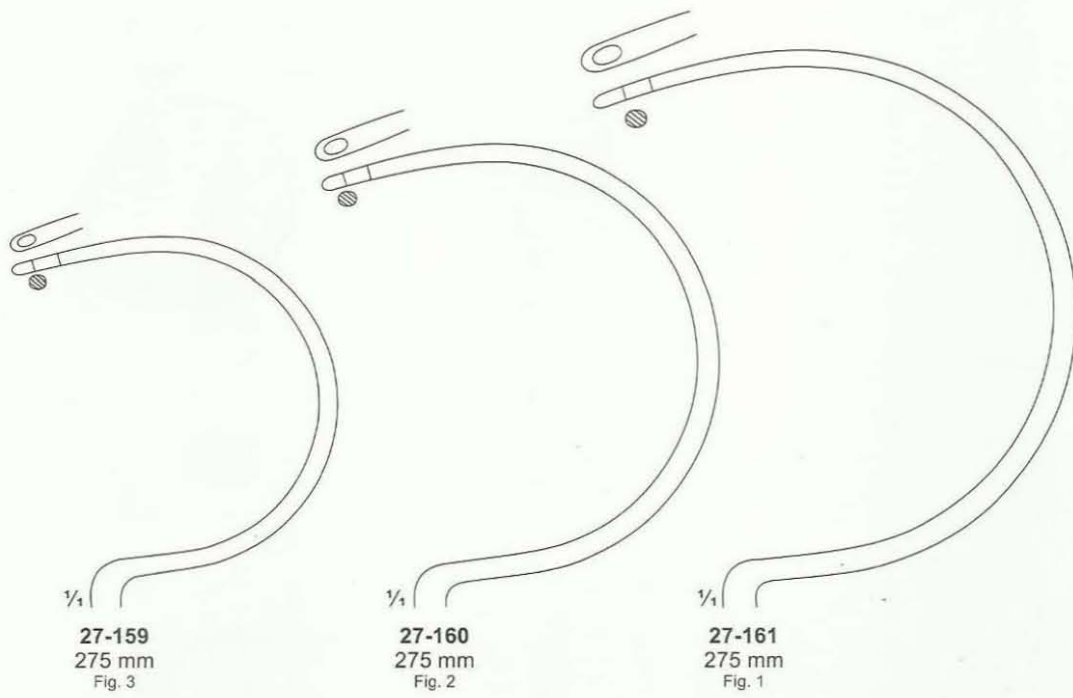

27-159
275 mm
Fig. 3

27-160
275 mm
Fig. 2

27-161
275 mm
Fig. 1



27-159 - 161
DEMEL
Wire guides

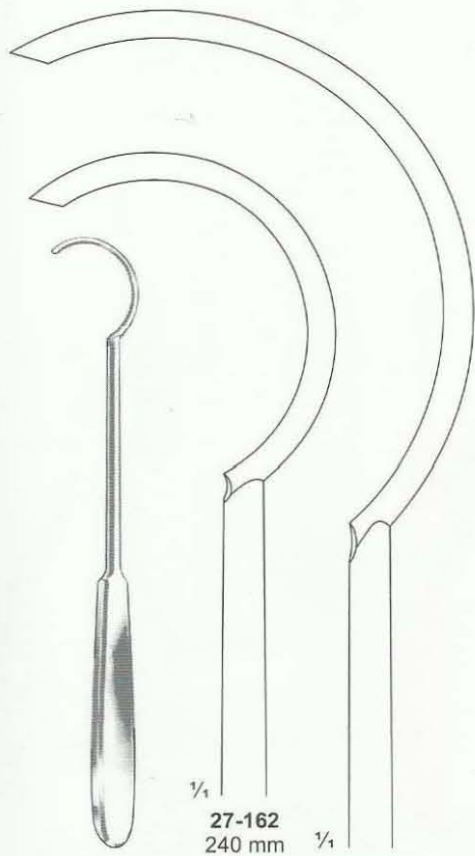

27-162
240 mm

27-163
270 mm

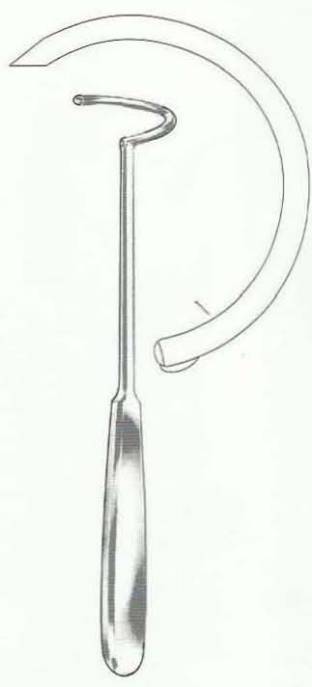

27-164
225 mm

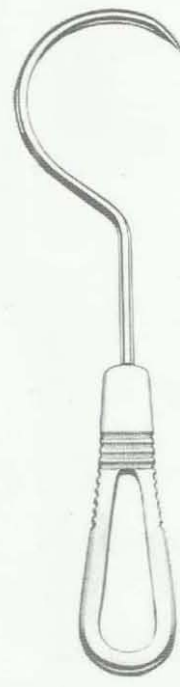

GRAFT PASSER
27-164A
XL-Large
Curved
Slot cut into head

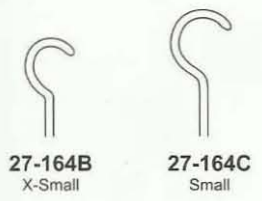

27-164B
X-Small

27-164C
Small



27-164D
Large

27-164E
X-Large

Jordan Instruments For Subcutaneous
Tibia Cerclage

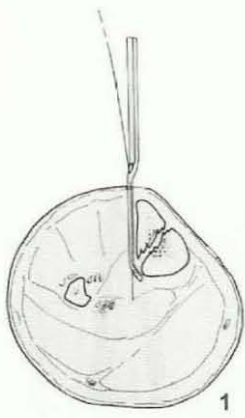

1

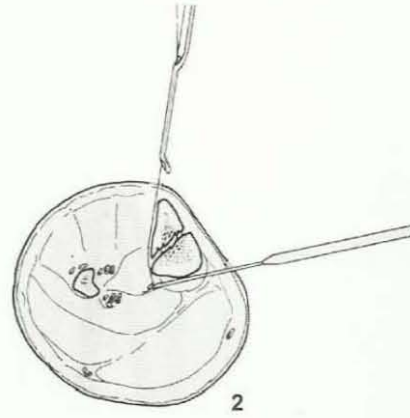

2

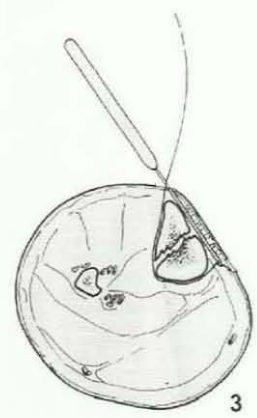

3

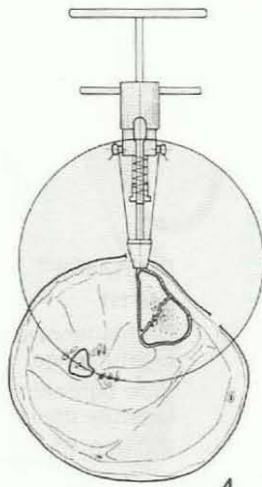

4

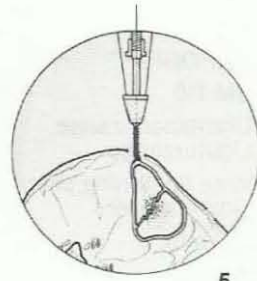

5

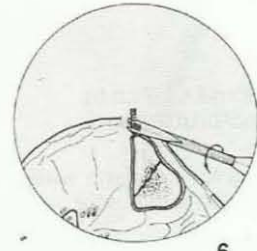

6



27-165
JORDAN



1/2

27-166
JORDAN



1/2

27-167
JORDAN



1/2

27-168
JORDAN

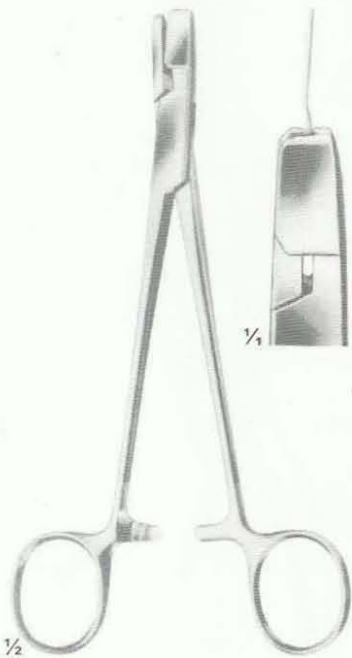

27-169
DUROGRIP
Holding forceps for cerclage wire, with lateral jaws to avoid wire slipping off
170 mm



27-170
DUROGRIP
Wire, tightening pliers, Ligature pliers
150 mm



27-171
DUROGRIP
Wire, tightening pliers, Ligature pliers
150 mm

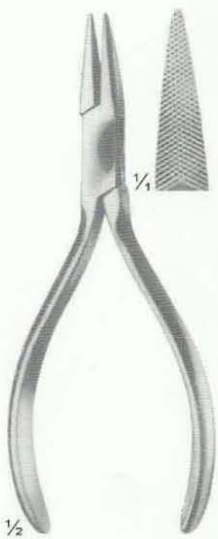

27-172
with serrated jaws
140 mm



27-173
one jaw smooth, one jaw serrated
140 mm



27-174
with serrated jaws
27-175
with longitudinal and transversal grooves
170 mm



27-176
190 mm

**Wire Holding Forceps, Flat-Nose Pliers,
Pliers For Bending & Cutting Wires**



27-177
130 mm

27-178
180 mm



27-177 - 178
Extraction pliers
for boring wires

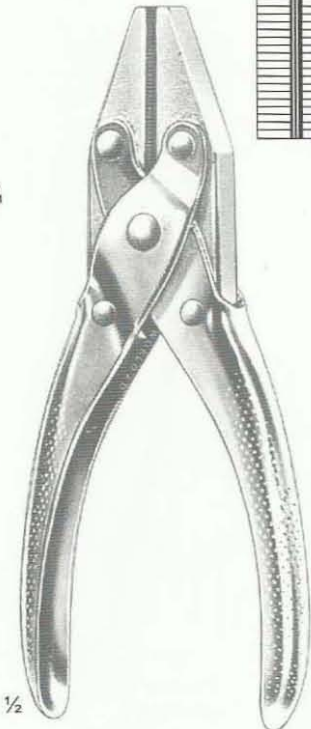

**FLAT-NOSED PLIERS
PARALLEL**
27-179 13 cm
27-179A 17 cm

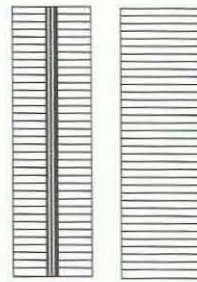

27-180A
17.5 cm
Tip width 7 mm
Maximum opening 1"
Small
27-180B
20 cm
Tip width 9 mm
Maximum opening 1"
Medium
27-180C
25.5 cm
Tip width 13 mm
Maximum opening 1"
Large

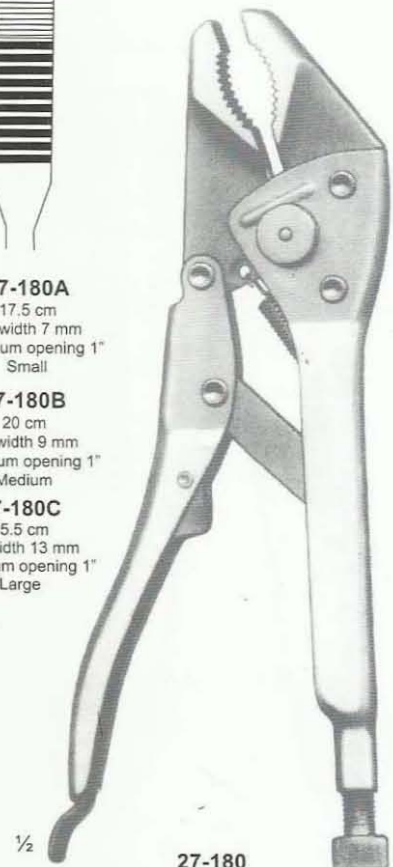

27-180
Vise grip
200 mm

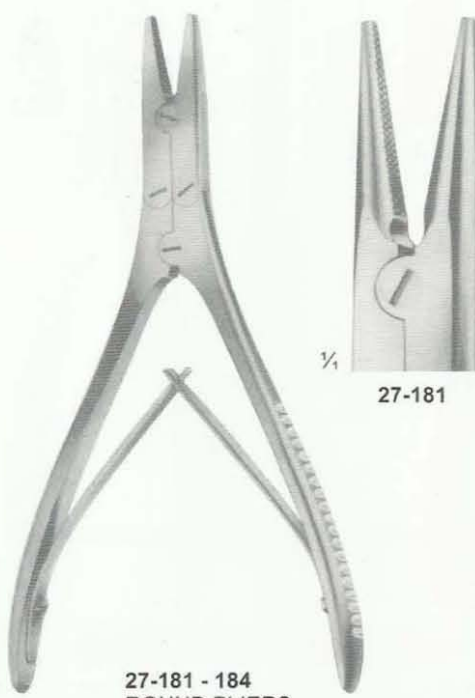

27-181 - 184
ROUND PLIERS
180mm

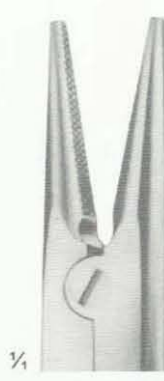

27-181

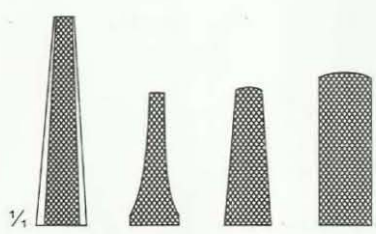

27-181 **27-182** **27-183** **27-184**

27-182 145 mm
27-183 180 mm
27-184 180 mm
Extraction pliers for wires

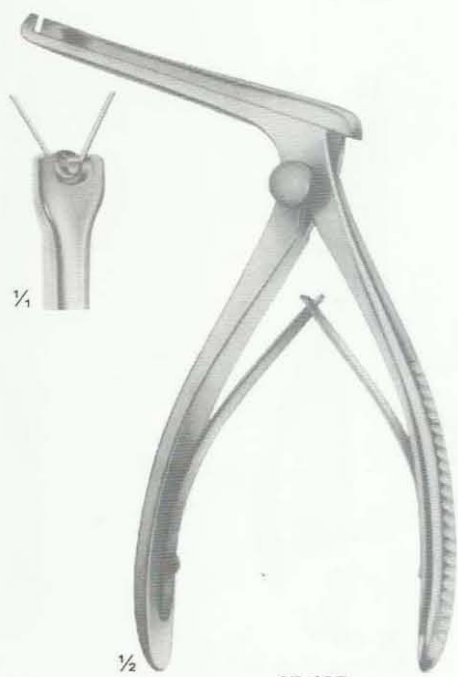

27-185
Bending pliers
for wires up to
1.8 mm diam.

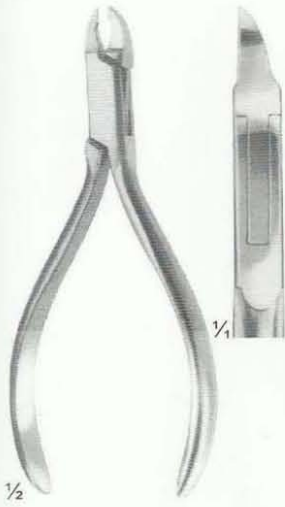

27-186 **27-187**
ANGLE DuroTIP
130 mm ANGLE
130 mm

for soft wire up to diam.	0,5 mm	0,6 mm
for hard wire up to diam.	0,3 mm	0,4 mm

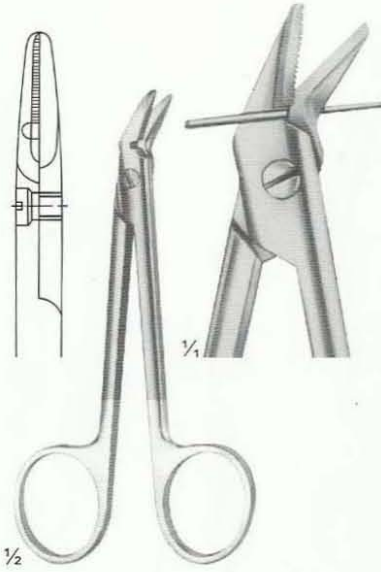

27-188 **27-189**
120 mm DuroTIP
120 mm

for soft wire up to diam.	1,2 mm	1,2 mm
for hard wire up to diam.	0,8 mm	0,8 mm

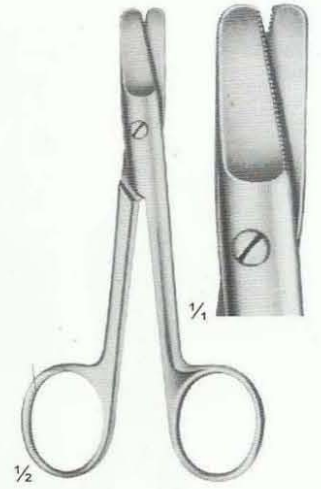

27-190
HARVEY
125 mm

0,4 mm
0,3 mm



27-191
150 mm

for soft wire up to diam	1,5 mm
for hard wire up to diam	1,0 mm



27-192
160 mm

1,5 mm
1,2 mm



27-193
140 mm
DuroTIP

1,5 mm
1,0 mm

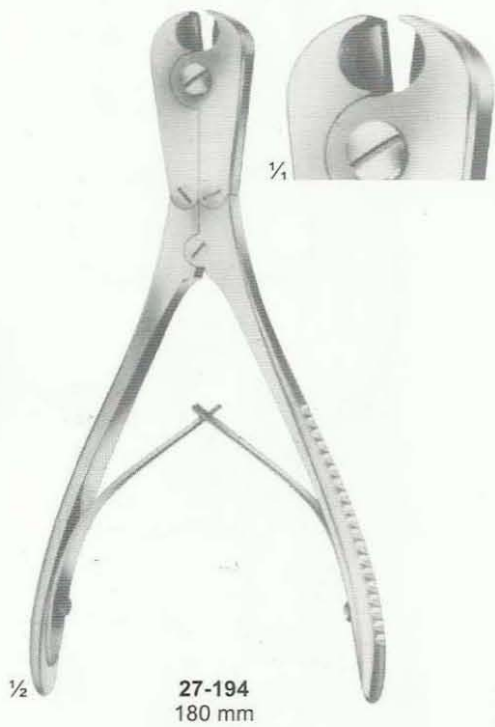

27-194
180 mm

for soft wire
up to diam. 2,0 mm
For hard wire 1,5 mm
up to diam
specially hardened
cutting edges, front
and lateral cutting
action



27-195
REILL
175 mm

for soft wire
up to diam. 2,0 mm
For hard wire 1,6 mm
up to diam
specially hardened
cutting edges, for
cutting off wires close
to the bone

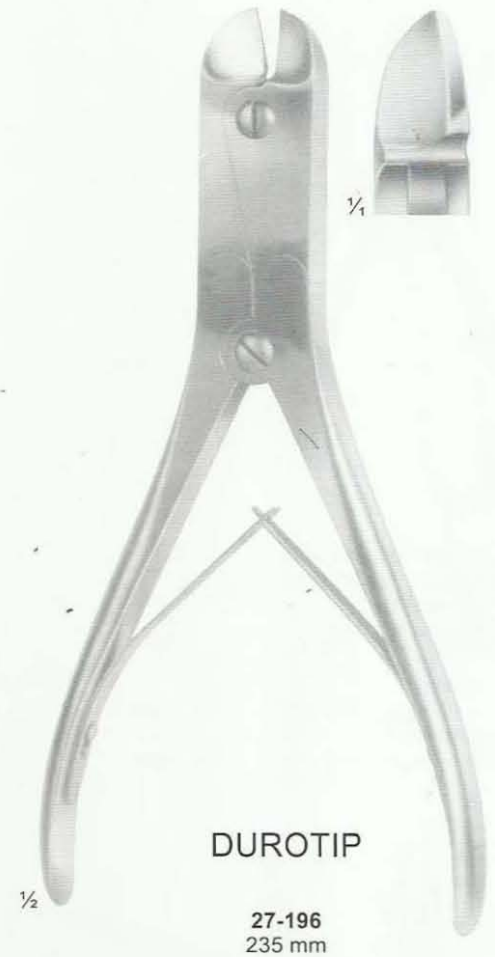

DUROTIP
27-196
235 mm

for soft wire
up to diam. 3,0 mm
For hard wire 2,2 mm
up to diam

Wire Cutting Pliers, Lateral and Front Cutting Action

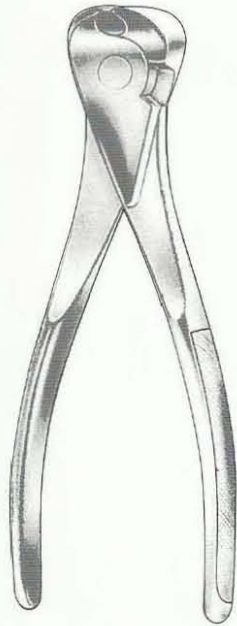

27-197A
16 cm

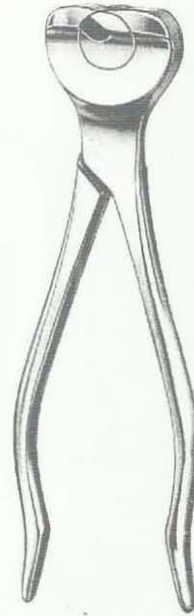

27-197B
16 cm
for soft wires up to 2.5 mm ϕ
for hard wires up to 2.0 mm ϕ



specially hardened cutting edges

1/2

27-197
240 mm

for soft wire up to diam. 2.0 mm
For hard wire 1.6 mm up to diam

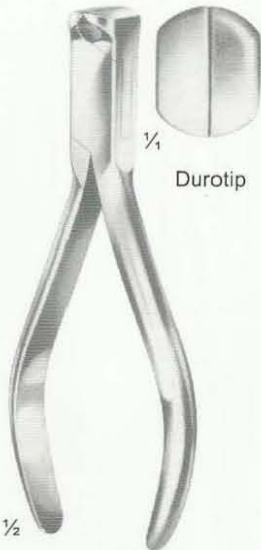

1/4

Durotip

1/2

27-198
145 mm

for soft wire up to diam. 1.5 mm
For hard wire 1.0 mm up to diam

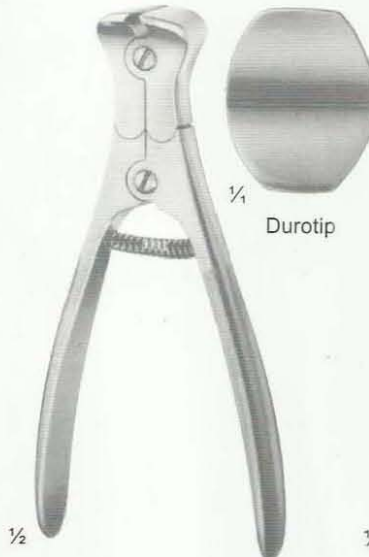

1/4

Durotip

1/2

27-199
145 mm

for soft wire up to diam. 2.0 mm
For hard wire 1.5 mm up to diam

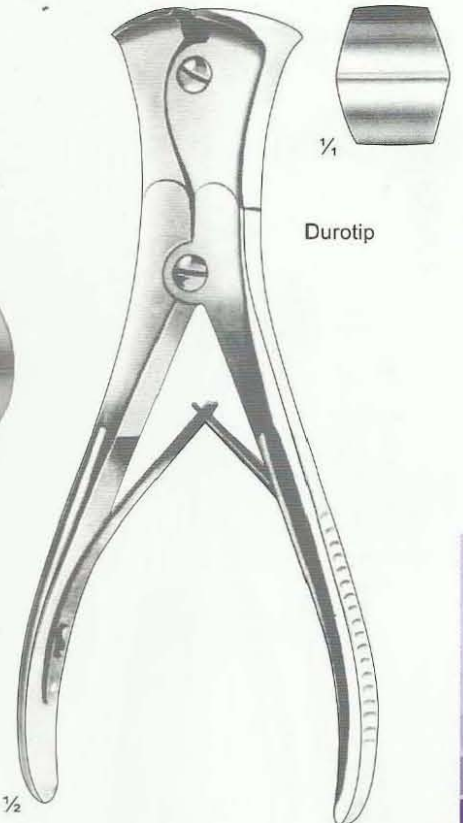

1/4

Durotip

1/2

27-200
220 mm

for soft wire up to diam. 3.5 mm
For hard wire 2.5 mm up to diam

Wire Cutting Pliers



27-201
320 mm

1/3



for soft wire
up to diam. 3,0 mm
For hard wire
up to diam. 3,0 mm

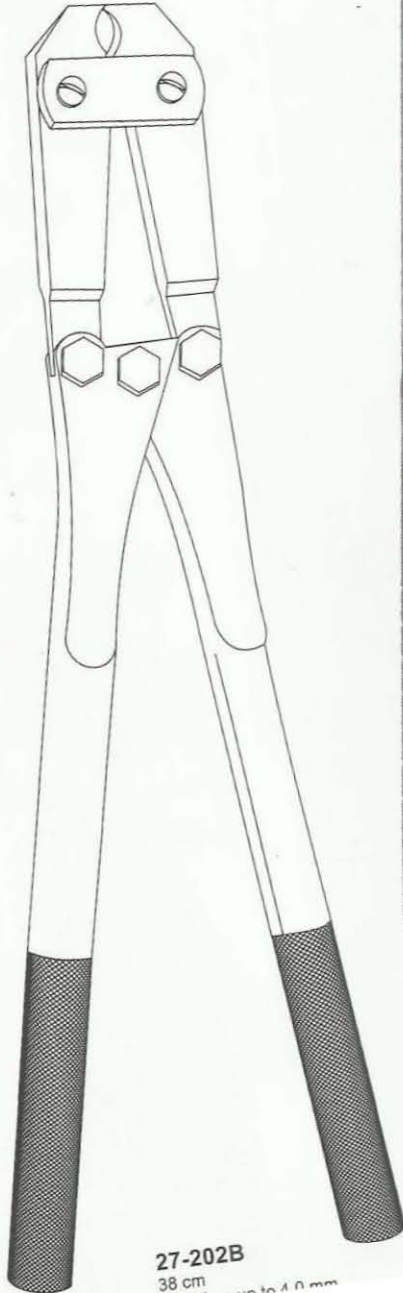
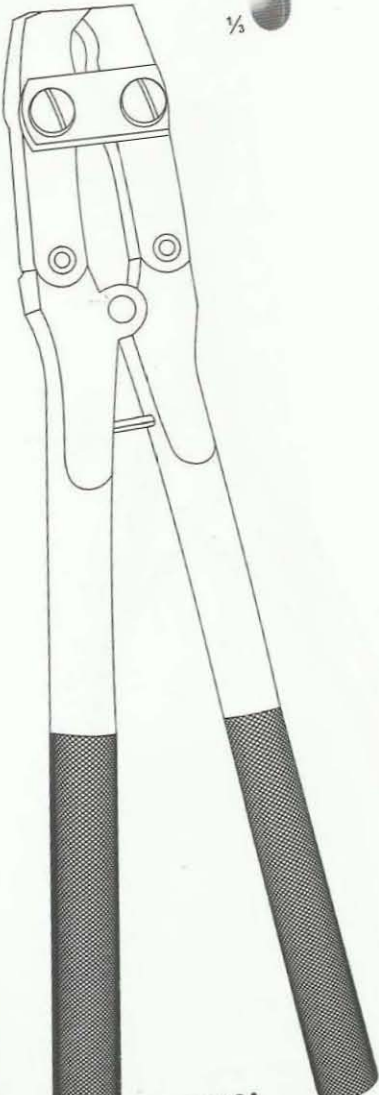

27-202B
38 cm
For wires up to 4.0 mm



DUROTIP

27-202
Cutter for cutting off
KIRSCHNER wires,
Tibia head screws,
bolts, pins, up to 6 mm diam.
470 mm

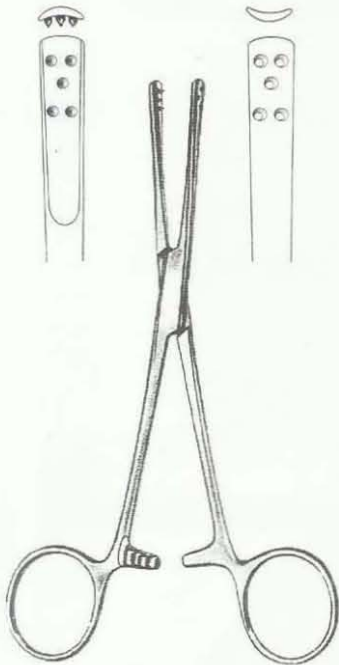

PENNER
27-203A
15.5 cm

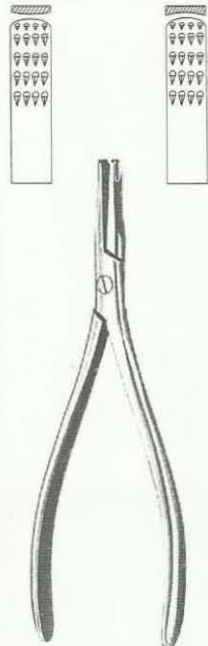

27-203
RADOLF
135 mm

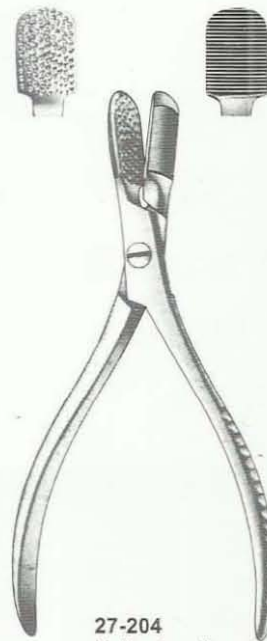

27-204
Nail extracting
forceps
145 mm

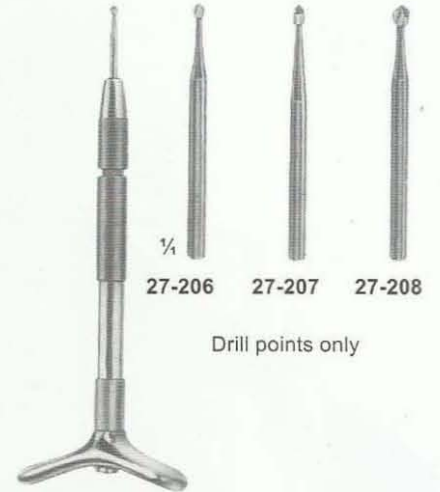

27-205
Finger nail drill
with 3 drill points

$\frac{1}{4}$
27-206 **27-207** **27-208**

Drill points only

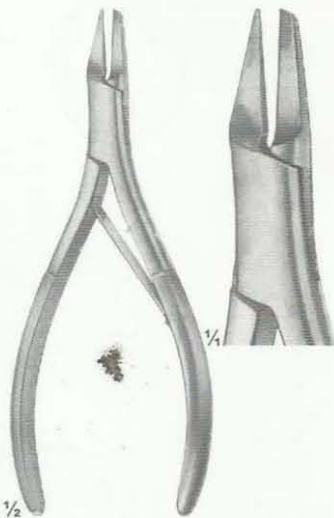

27-209
Nail splitting
forceps
135 mm

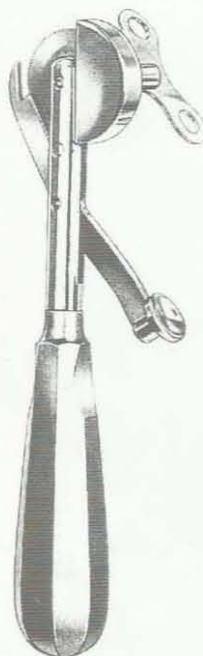

27-210
17 cm
Ring cutter

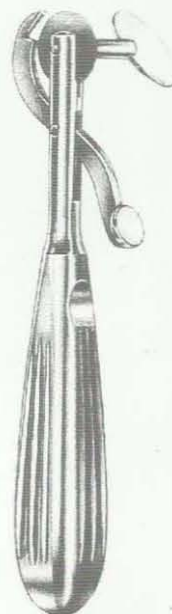

WALTON
27-210A
16 cm
27-210B
Spare blade for ring cutters



27-211
Finger ring saw
150 mm

	SECTION	PAGE
Plaster Instruments	28	393-397
Suction Instruments		398-404
Sterilizing Forceps	29	405

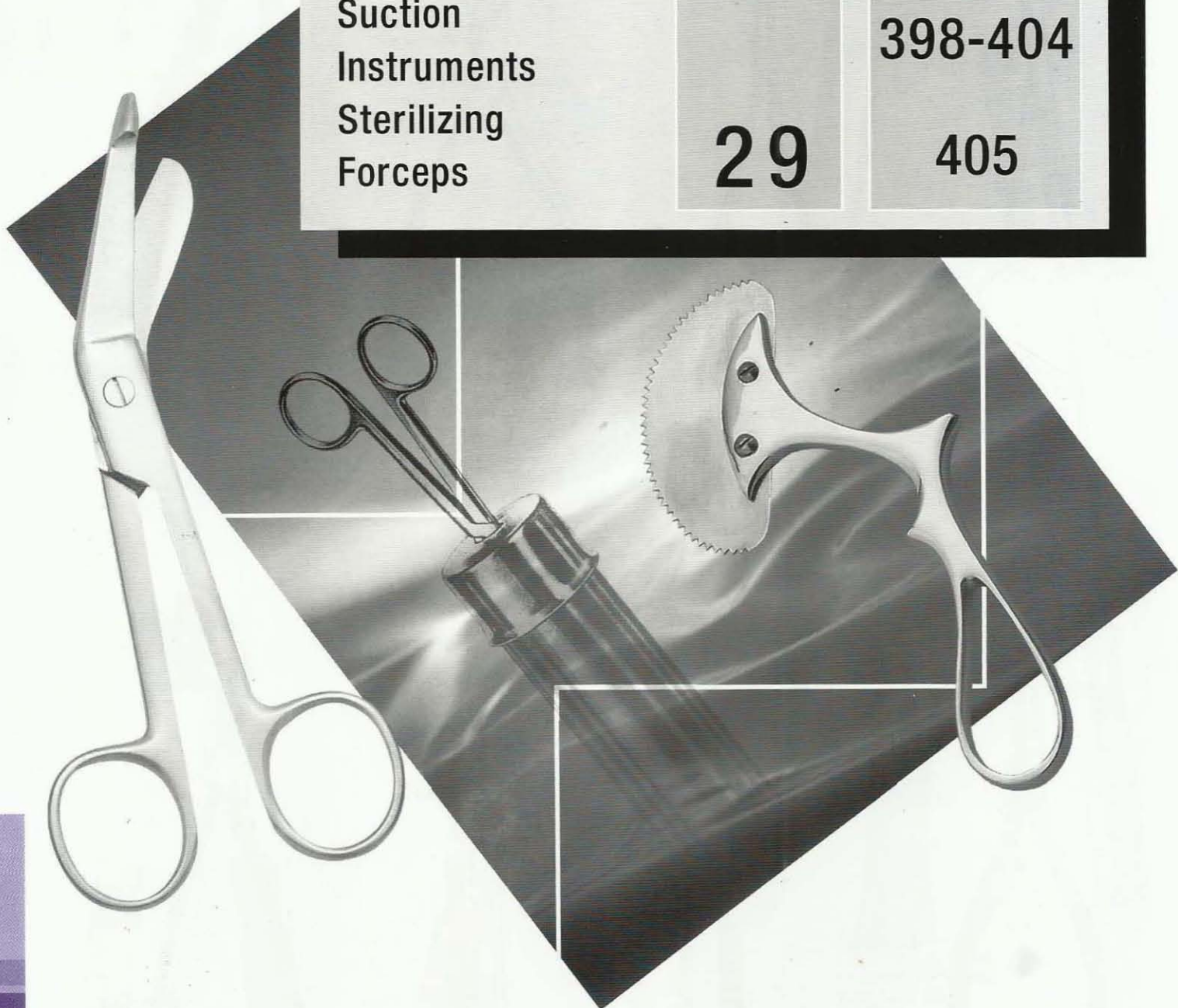

Plaster Knives



with ebony handle

28-101
HOPKINS
200 mm



28-102
ESMARCH
180 mm



REINER
28-103
18.5 cm

Plaster Saw

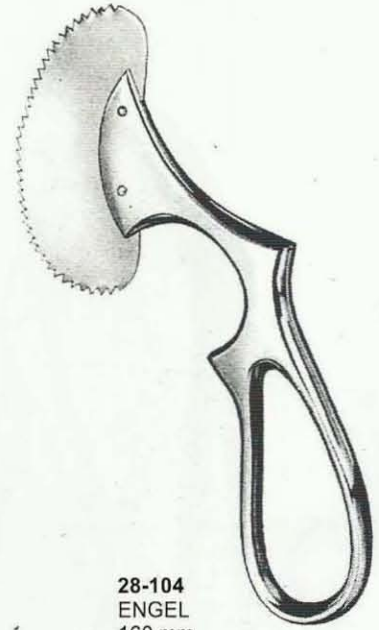

28-104
ENGEL
160 mm



MOD. NEW
28-105
21 cm

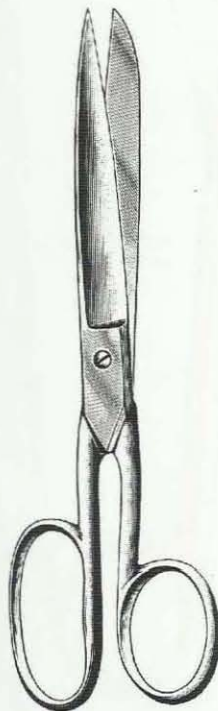

SMITH
(Mod. USA)
28-106
20 cm

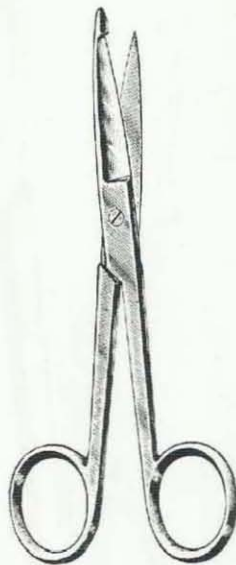

KNOWLES
28-107 Straight
28-108 Angled
14 cm

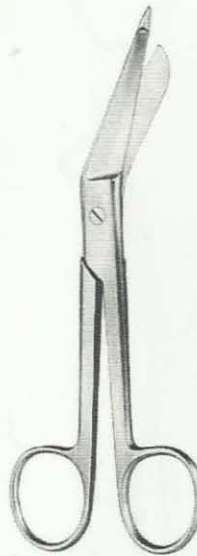

LISTER
28-109 (9cm)
28-110 (14cm)
28-111 (18cm)
28-112 (20cm)

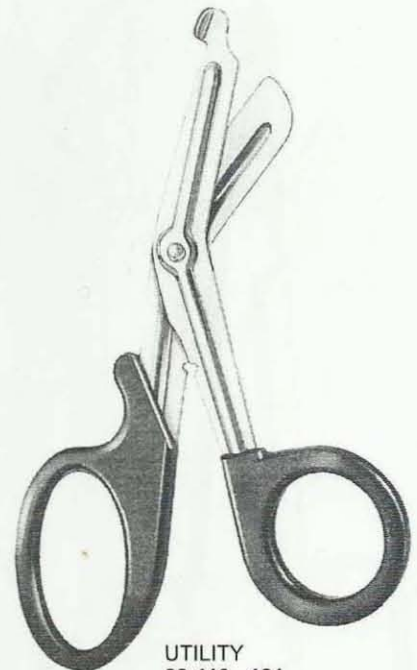

UTILITY
28-113 - 121
180mm

- | | |
|---------------------|---------------------------|
| 28-113 Black | 28-117 Yellow |
| 28-114 Red | 28-118 White |
| 28-115 Blue | 28-119 Orange |
| 28-116 Green | 28-120 Violet |
| | 28-121 Bright Pink |

For small plaster dressings



28-122
160 mm

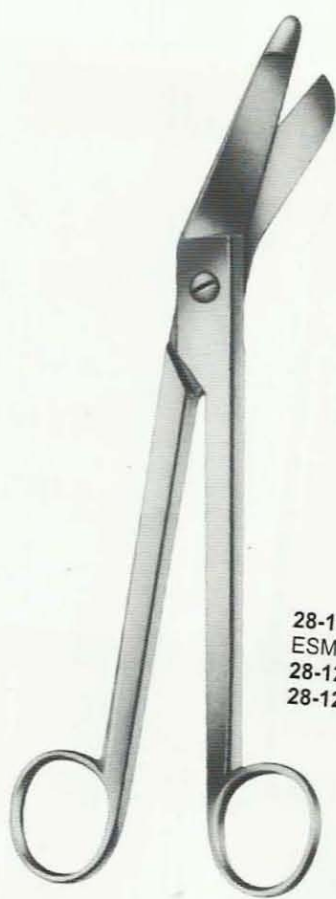

28-123 - 124
ESMARCH
28-123 200mm
28-124 230mm



28-125
BERGMANN
230 mm

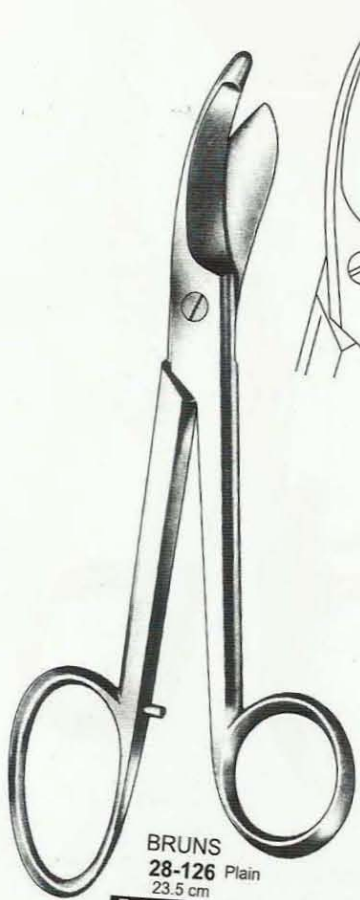

BRUNS
28-126 Plain
23.5 cm

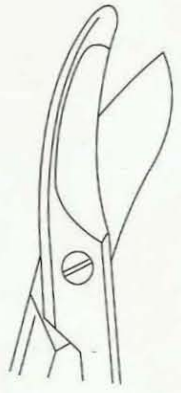

TC GOLD
28-126A Serrated
24 cm
Open shanks with pin

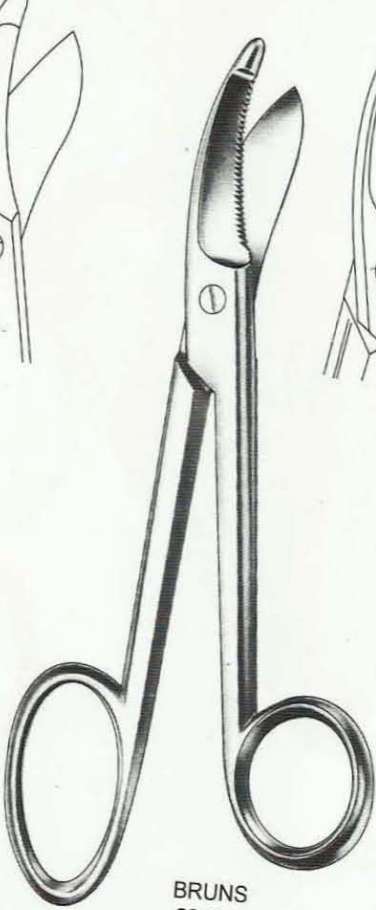

BRUNS
28-127
23.5 cm

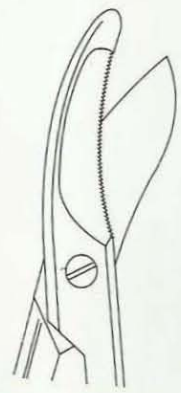

Closed shanks, serrated

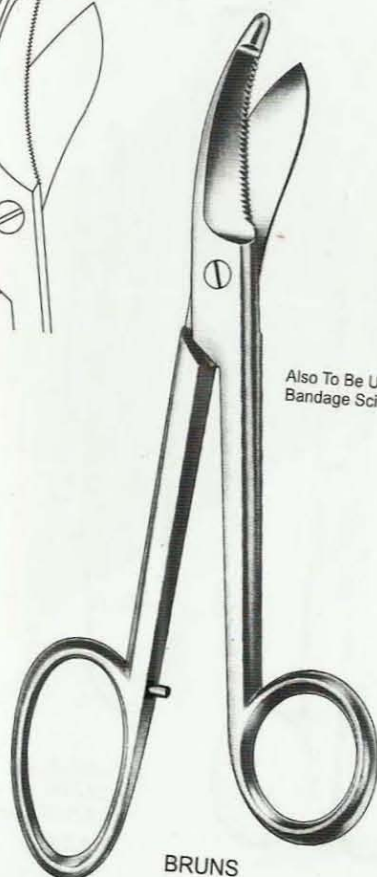

BRUNS
28-128
24 cm

Open shanks

Also To Be Used As
Bandage Scissors

Also To Be Used As
Bandage Scissors

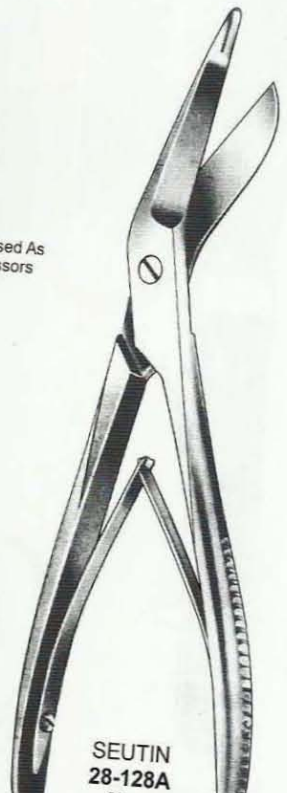

SEUTIN
28-128A

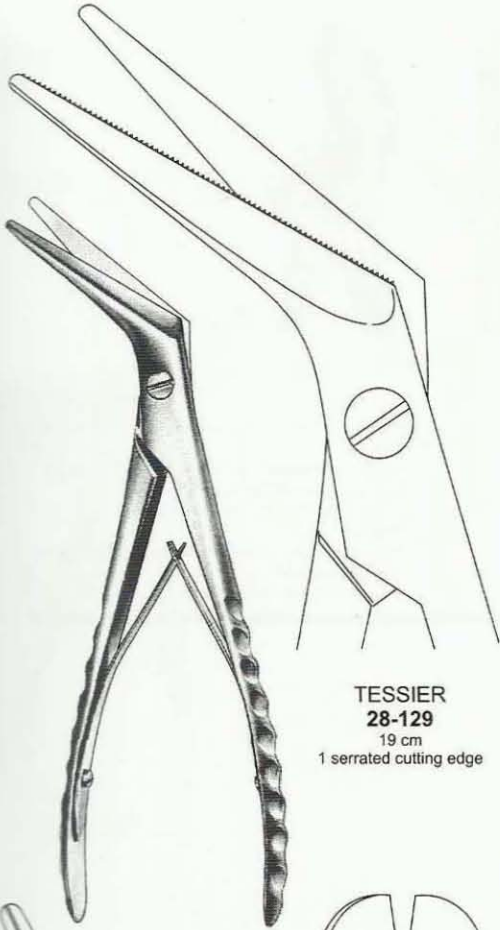

**TESSIER
28-129**
19 cm
1 serrated cutting edge

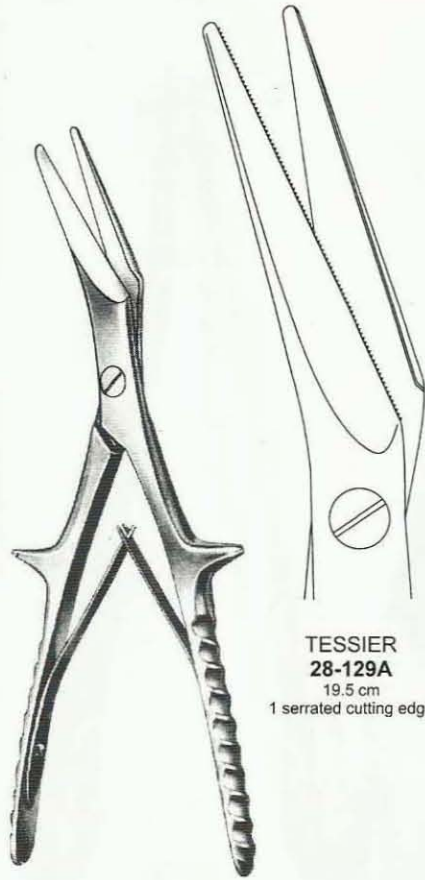

**TESSIER
28-129A**
19.5 cm
1 serrated cutting edge

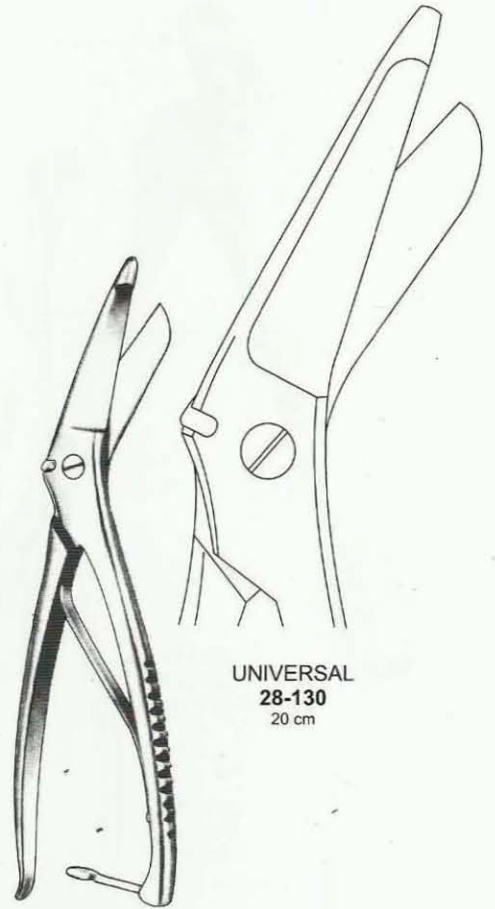

**UNIVERSAL
28-130**
20 cm

Bandage Scissors

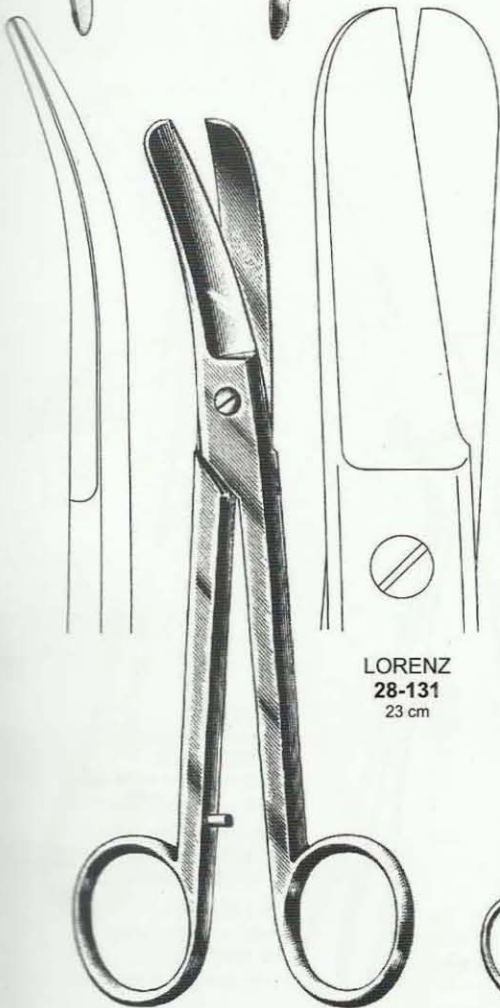

**LORENZ
28-131**
23 cm

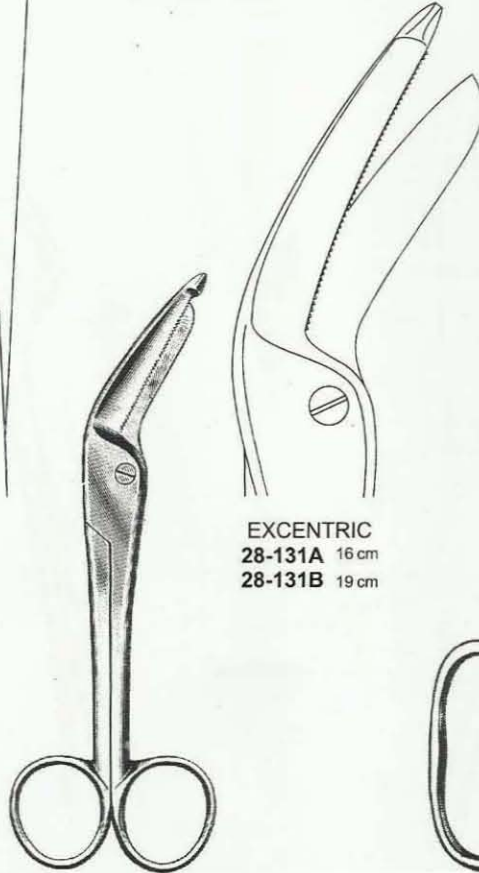

**EXCENTRIC
28-131A 16 cm
28-131B 19 cm**

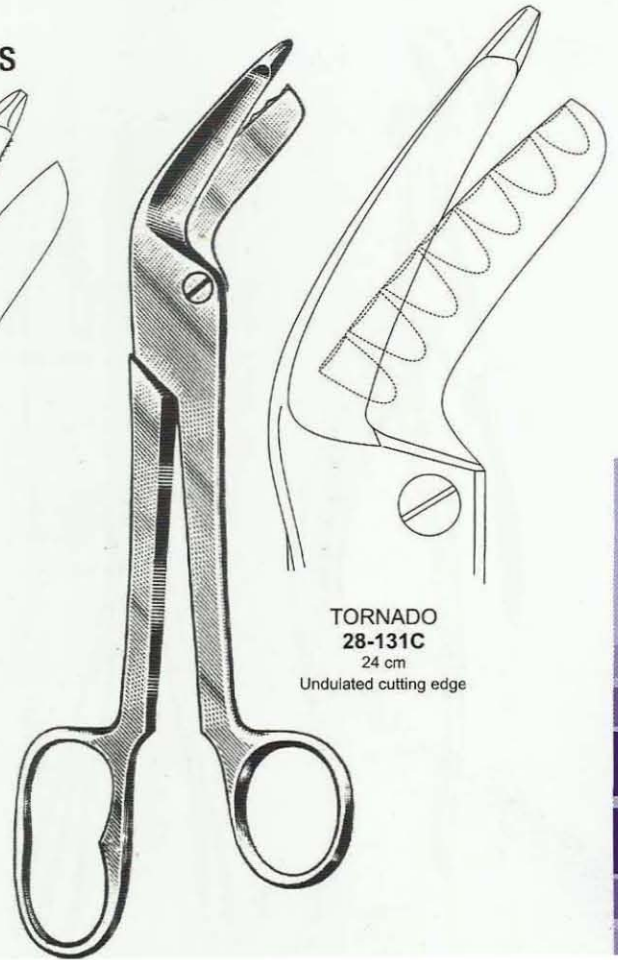

**TORNADO
28-131C**
24 cm
Undulated cutting edge

28-132A
Spare blade



1/3

28-132
STILLE
260 mm

28-133A
Spare blade

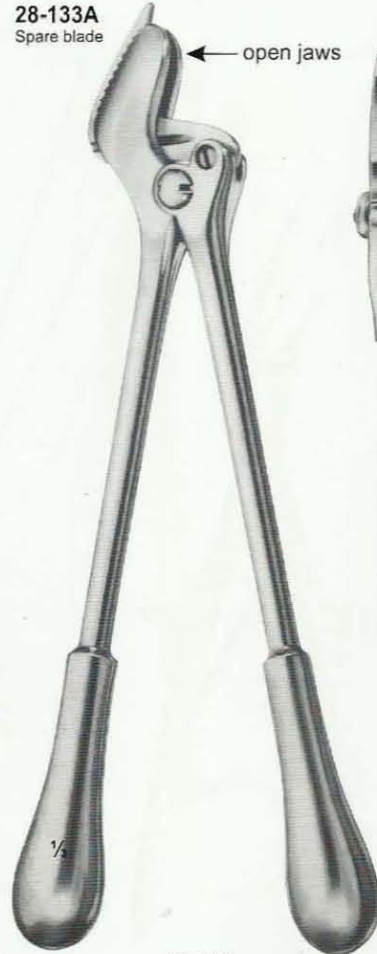

1/3

28-133
STILLE
360 mm



open jaws

Special features:

The construction of the open jaws avoids tiresome clogging by plaster remnants and allows furthermore an easy cleaning. The shears do not glide off the plaster owing to the deep teething on the jaws. The knives with hollow grinding have a better cutting ability and therefore less force is required. The knives are guided by ball bearings.

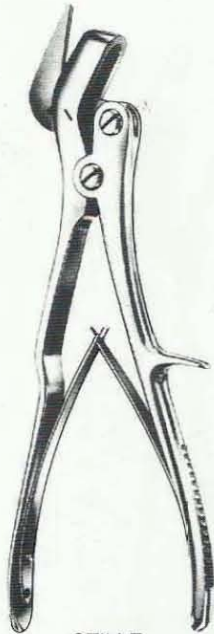

STILLE
28-134
24 cm

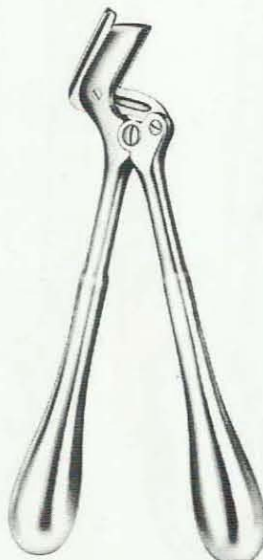

STILLE-MINI
28-135
Blade with reinforced back
28-136
Blade without reinforced back
20 cm

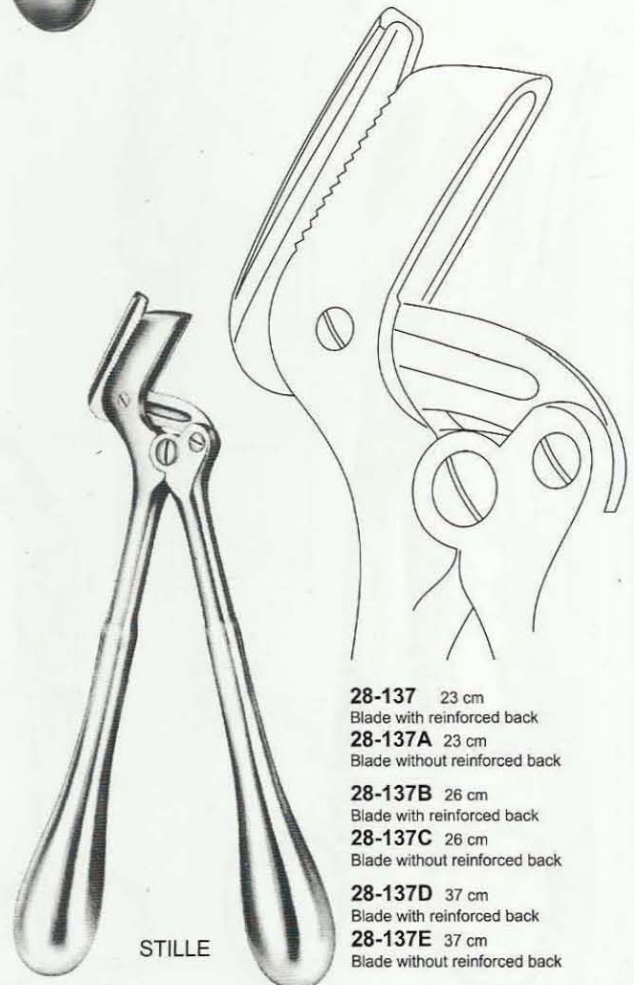

28-137 23 cm
Blade with reinforced back
28-137A 23 cm
Blade without reinforced back
28-137B 26 cm
Blade with reinforced back
28-137C 26 cm
Blade without reinforced back
28-137D 37 cm
Blade with reinforced back
28-137E 37 cm
Blade without reinforced back

STILLE

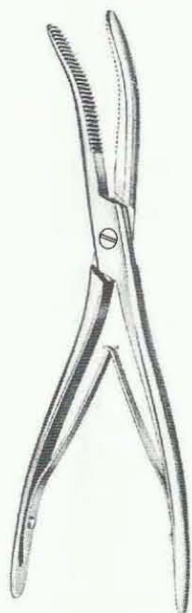

WOLFF



28-138
18 cm



28-138A
24 cm

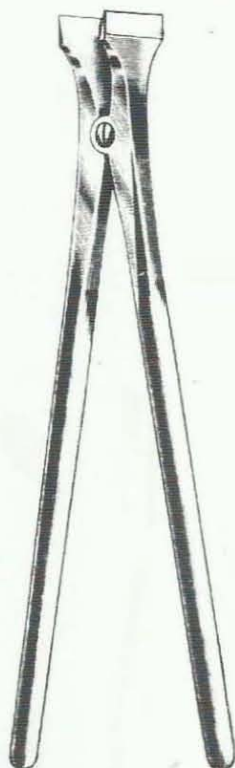

BEESON
28-138B
30 cm

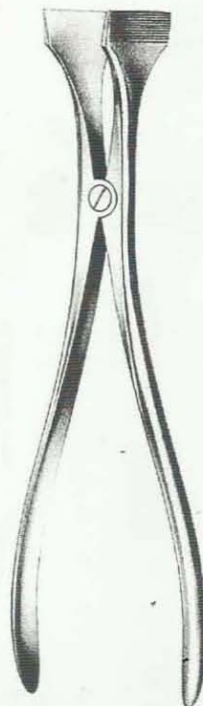

HENNIG
28-139
28 cm

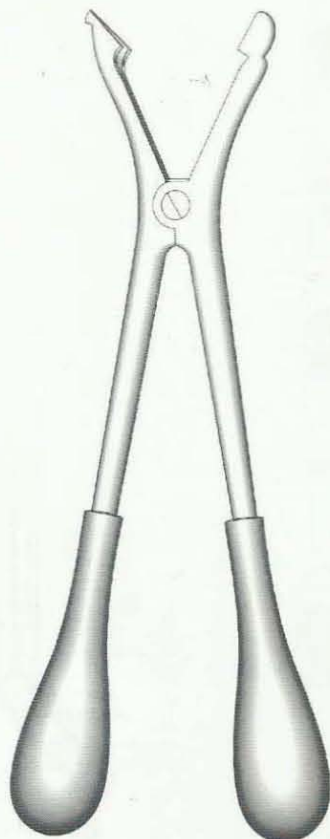
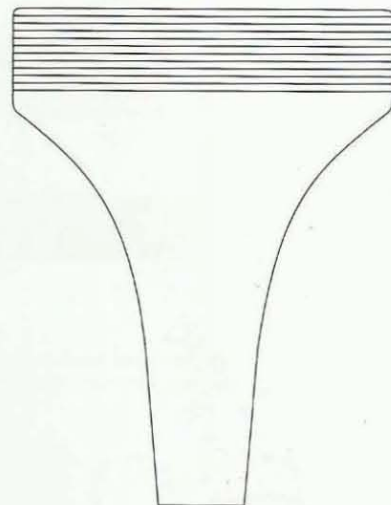

HAGLUND
28-140
28 cm

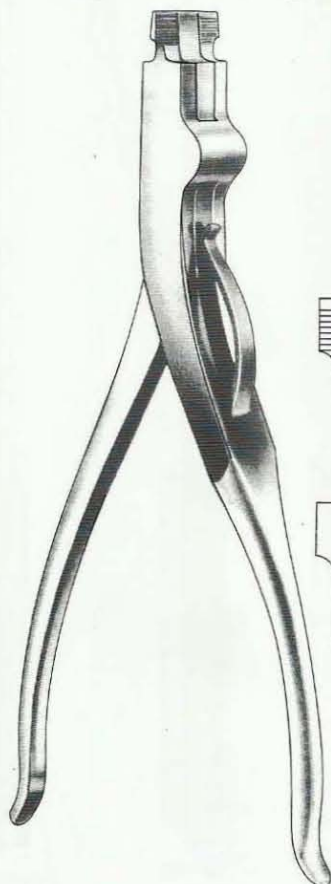

MOD.USA
28-141
23 cm

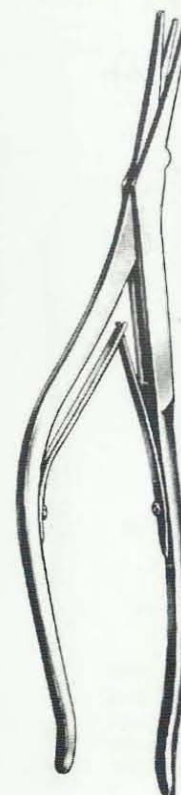
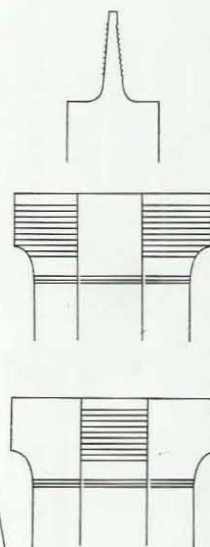

SMITH
28-142
23.5 cm



29-112
For aspirating
fluid from the excretory
ducts of large glands
and for keeping the
operating area clear
170 mm

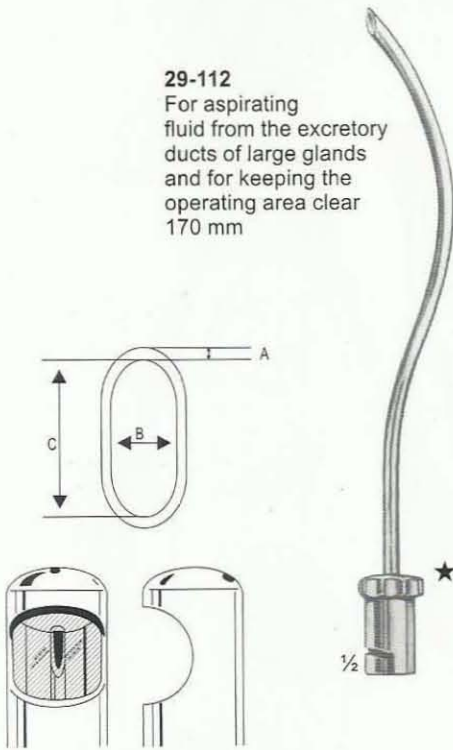

	A	B	C
29-102	5 mm	1 mm	4.0 mm
29-103	6 mm	1 mm	5.0 mm
29-103A	7 mm	1 mm	5.5 mm
29-103B	8 mm	1 mm	6.0 mm
29-103C	9 mm	1 mm	6.5 mm
29-103D	10 mm	2 mm	7.5 mm
29-103E	12 mm	2 mm	10 mm
29-103F	14 mm	2 mm	11 mm

Uterine suction tube

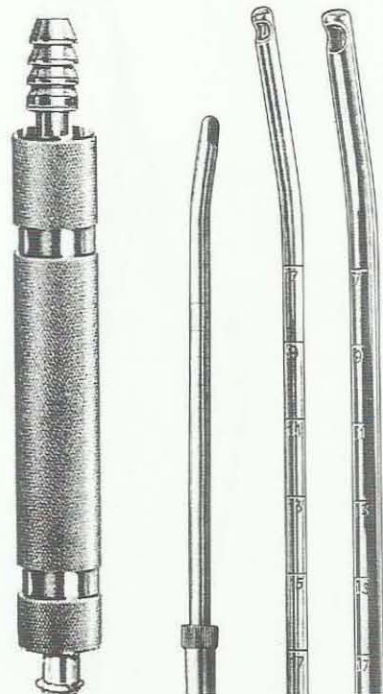

29-101
13 cm

Uterine suction tubes



29-104
29 cm
3 mm
Specimen &
aspiration



29-105
29 cm
4.5 mm
Specimen &
aspiration



Aspirating curettes
29 cm



29-106
6 mm



29-107
8 mm



29-108
10 mm



29-109
12 mm



29-110
14 mm



29-113
Trocar
For puncturing
150 mm



29-114
For clearing
large quantities
of fluid
190 mm

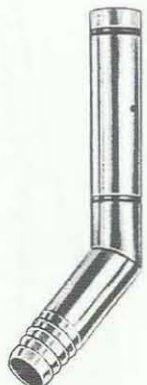

29-111
12 cm
Coupling piece

29-115 150mm
Suction handle, with vacuum regulator and finger cut-off, brass, mirror-finish chromium-plated

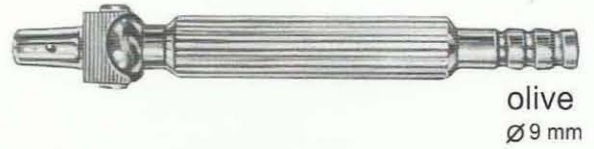

olive
Ø9 mm

29-116 170mm
Suction handle, with hand regulation valve and quick-shutter, brass, mirror-finish chromium-plated



olive
Ø9 mm

★ Both suction handles have bayonet fitting and can be used for the suction cannulae.

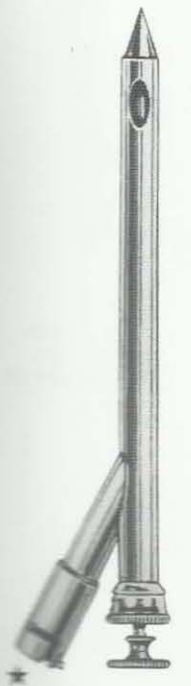

29-117
Trocar
For puncturing
170 mm



★
29-118
Hollow needle,
sharp
150 mm

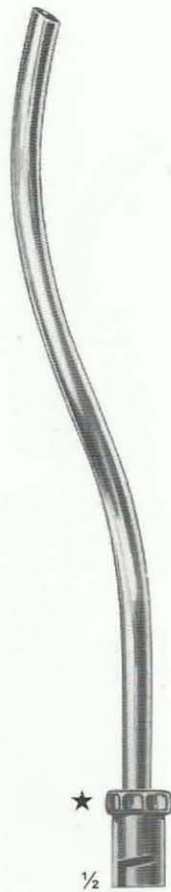

★
29-119
double curved
For general
surgery
230 mm

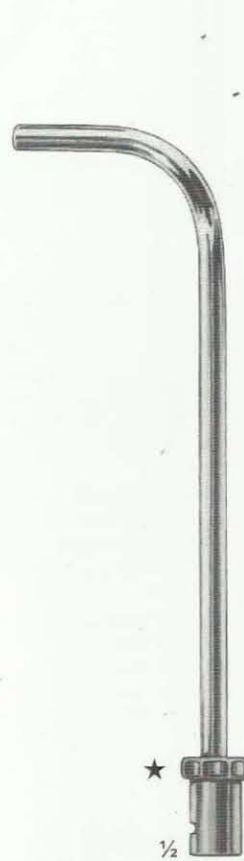

★
29-120
For tonsillectomy,
oral and laryngeal
operations
190 mm

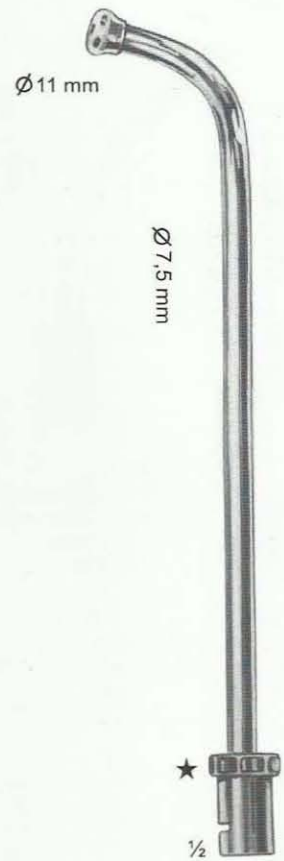

★
29-121
For tonsillectomy,
oral and laryngeal
operations
220 mm

★ With bayonet fitting to be used with suction handles (29-115 - 29-116)

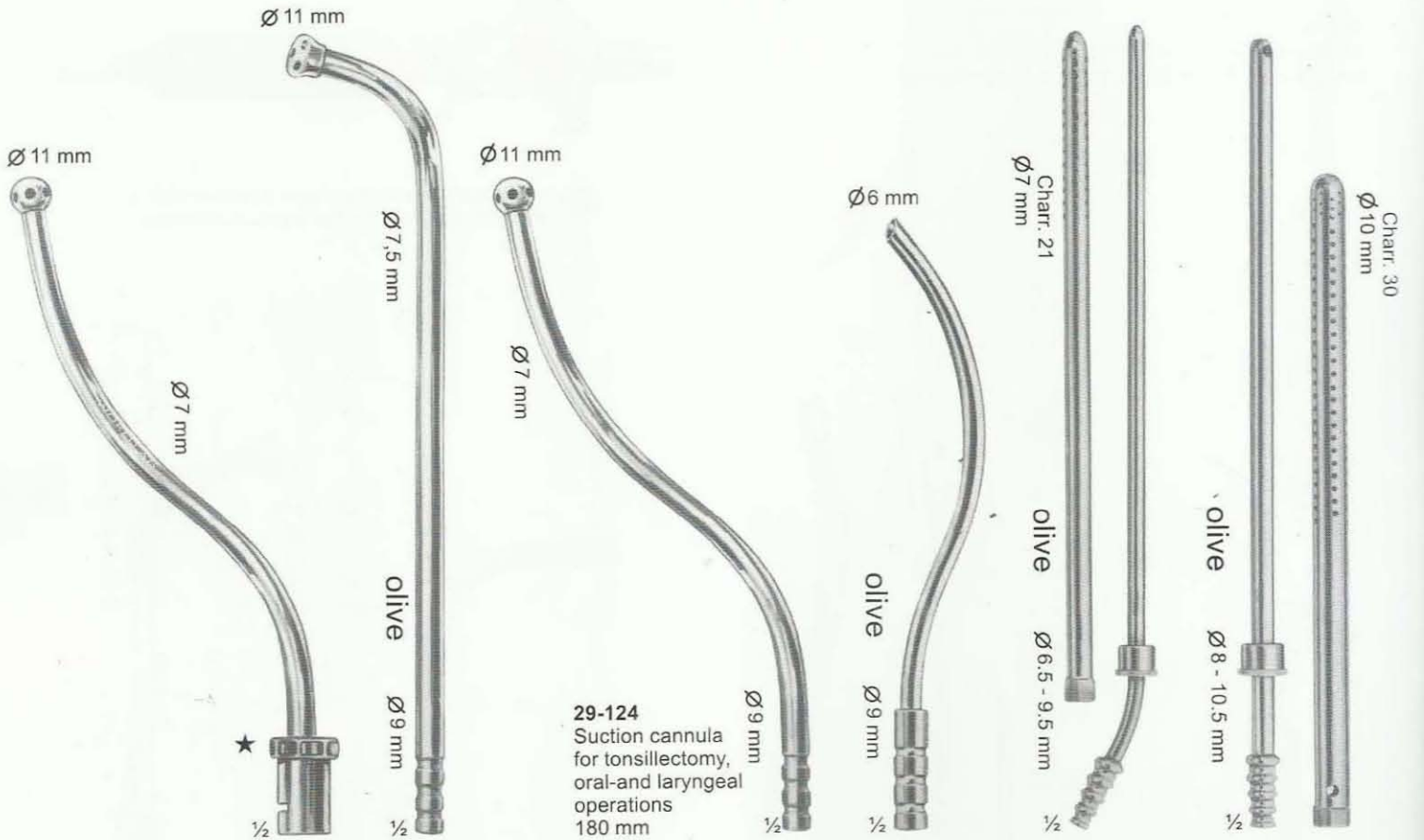

29-122
For tonsillectomy,
oral-and laryngeal
operations
180 mm

29-123
Suction cannula
for tonsillectomy,
oral-and laryngeal
operations
220 mm

29-124
Suction cannula
for tonsillectomy,
oral-and laryngeal
operations
180 mm

29-125
S-shaped blunt cannula
for aspirating fluid from
the excretory ducts of
large glands and for
keeping the operating
area clear
170 mm

29-126
POOLE
Suction cannula,
with outer tube
to be screwed of
225 mm

29-127
POOLE
Suction cannula,
with outer tube
to be screwed off
225 mm



29-128
YANKAUER
with especially large
central bore, 4,8 mm
diam.
285 mm



29-129
YANKAUER
with central bore,
2,0 mm diam.
285 mm



29-130
DE-BAKEY
with central bore,
3,0 mm diam. with
lateral slots
275 mm



29-131
DE-BAKEY
with finger cut-off
and stylet
270 mm



29-132
DE-BAKEY
with finger cut-off
and stylet
160 mm

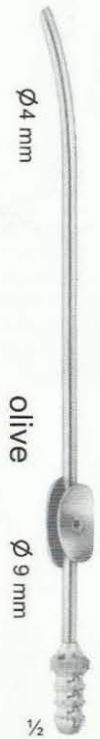

29-133
with finger
cut-off
190 mm



olive
Ø 6-9 mm

- 29-134 Ø 1,5 mm
- 29-135 Ø 2,0 mm
- 29-136 Ø 2,5 mm
- 29-137 Ø 3,0 mm

½

29-134 - 137
PLESTER
with finger cut-off and stylet, thumb piece parallel to curve, with LUER hub
195 mm

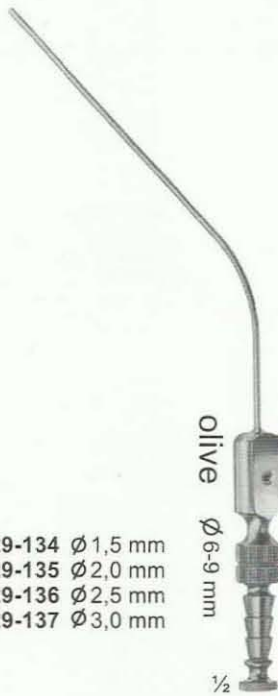

olive
Ø 6-9 mm

- 29-138 Ø 2,0 mm
- 29-139 Ø 2,5 mm
- 29-140 Ø 3,0 mm
- 29-141 Ø 4,0 mm
- 29-142 Ø 5,0 mm

½

29-138 - 142
FERGUSON
with finger cut-off and stylet, thumb piece 90° to curve, with LUER hub
180 mm



olive
Ø 6-9 mm

½

29-143 4,0 mm Ø
FERGUSON
insulated, with finger cut-off and stylet, thumb piece 90° to curve, with LUER hub
180 mm



olive
Ø 6-9 mm

½

29-144 3,0 mm Ø
29-145 5,0 mm Ø
FRAZIER
with finger cut-off and stylet, thumb piece 90° to curve, with LUER hub
180 mm

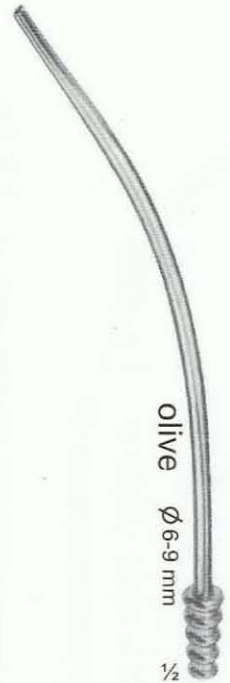

olive
Ø 6-9 mm

½

29-146
5,0 mm diam, Tip 6,5 mm wide, Nasal suction tube, with LUER hub
180 mm



½

29-147 4,5 mm Ø
29-148 5,5 mm Ø
Nasal suction tubes
175 mm



½

29-149
GORNEY
Suction dissector
180 mm



olive
Ø 6-10 mm

½

29-150 4 mm wide
29-151 5 mm wide
Suction raspatories, sharp, bayonet-shaped, with stylet



olive
Ø 9 mm

½

29-152
LOPEZ-REINKE
Tonsil dissector with suction device
235 mm

29-153
WULLSTEIN
 Suction tube, conical, silver, olive
 with LUER hub
 160 mm

Ø 1,75 mm

olive Ø 3 mm
 1/2
 Ø 8 mm

29-154 1,5 mm-**29-155** 2,0 mm
WULLSTEIN
 Suction tube, cylindrical, silver, with
 stylet olive with LUER hub
 160 mm

olive Ø 8 mm
 1/2

Usable length

YASARGIL usable length diam.		YASARGIL usable length diam.	
29-156	130 mm 1,5 mm	29-164	130 mm 2,5 mm
29-157	150 mm 1,5 mm	29-165	150 mm 2,5 mm
29-158	180 mm 1,5 mm	29-166	180 mm 2,5 mm
29-159	220 mm 1,5 mm	29-167	220 mm 2,5 mm
29-160	130 mm 2,0 mm	29-168	130 mm 3,5 mm
29-161	150 mm 2,0 mm	29-169	150 mm 3,5 mm
29-162	180 mm 2,0 mm	29-170	180 mm 3,5 mm
29-163	220 mm 2,0 mm	29-171	220 mm 3,5 mm
		29-172	180 mm 4,5 mm

olive
 Ø 6,5-9 mm
 with LUER hub

29-173 - 175
LANDOLT
 150 MM
 diam Ø 3 mm

29-173 8 mm / curved
29-174 11mm / curved
29-175 15mm / curved

Ø 3.5 mm

Ø 2.0 mm

29-176 500 mm-**29-177** 350 mm
 with rubber tip,
 with LUER hub

olive Ø 9 mm
 1/2

29-178 2,0 mm diam **29-179** 2,5 mm diam **29-180** 3,0 mm diam
 with finger cut-off,
 thumb piece 90° to
 curve, with LUER hub
 250 mm

olive Ø 6-9 mm
 1/2

Combined Suction and Irrigation Cannulae, Coagulation Suction Cannulae

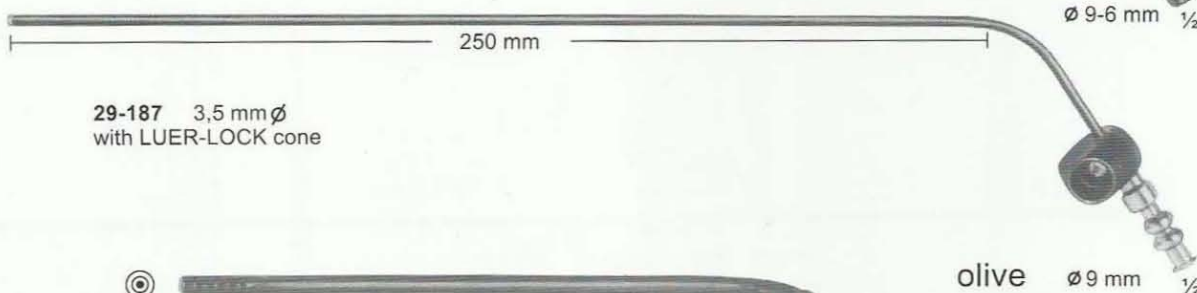
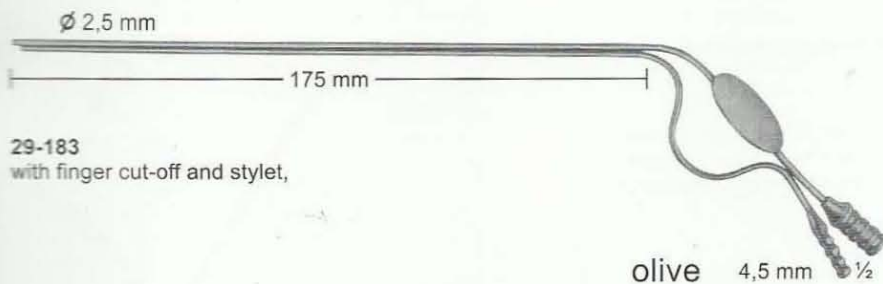
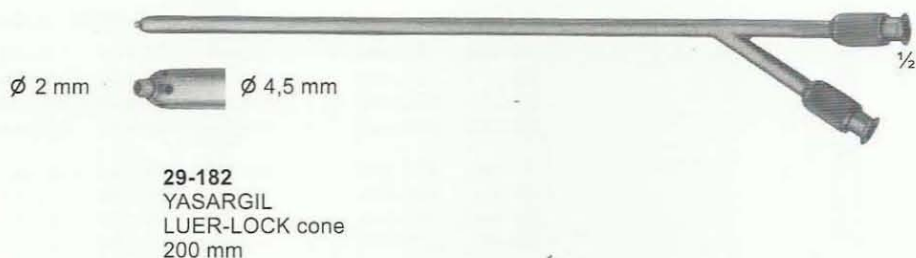

4 mm diam., Untarnished
contact to be touched by
HF-electrodes



MAYO
29-189
14 cm

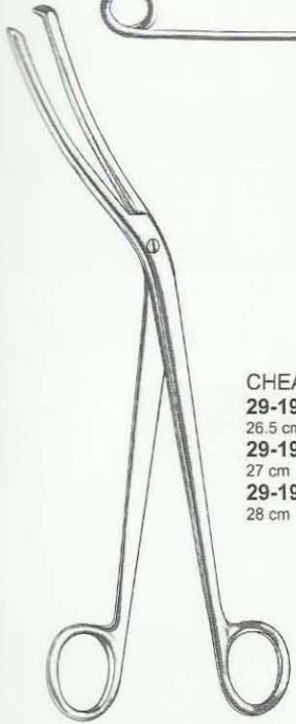

CHEATLE
29-190
26.5 cm
29-191
27 cm
29-192
28 cm

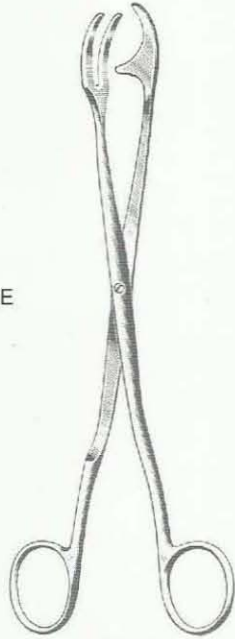

ROGGE
29-193
23 cm

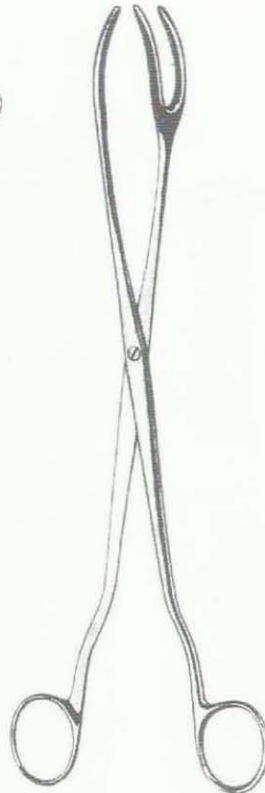

29-194 20 cm
29-195 30 cm

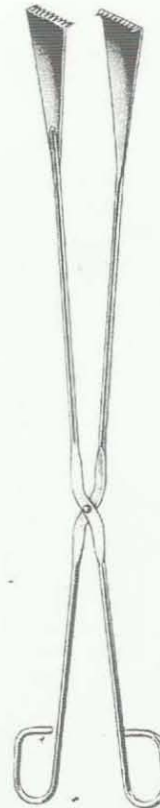

SAUERBRUCH
29-196
55 cm



MODELL
29-197
58 cm



PYE-SMITH
HARRISON
29-198 25 cm
29-199 30 cm

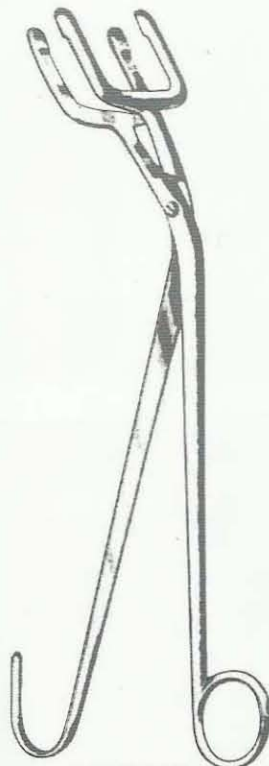

HARRISON
29-200 25 cm
29-201 30 cm
29-202 35 cm
29-203 45 cm

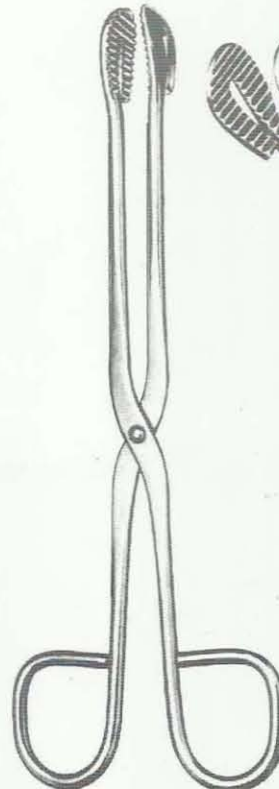

UNIVERSAL
29--204 20 cm
29--205 28 cm



NEW
With secure locking device
29-206 20 cm
29-207 25 cm
29-208 30 cm
29-209 40 cm

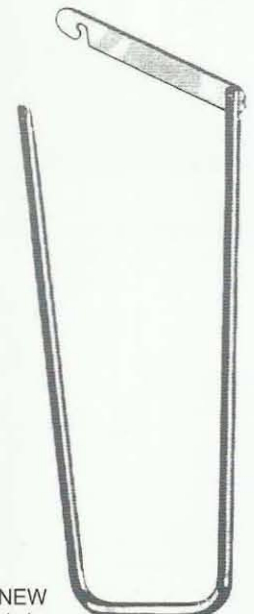

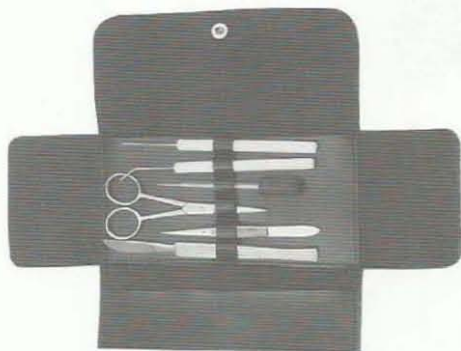

29-210
GENERAL BIOLOGY DISSECTING SET
SINGLE LEATHER CASE.

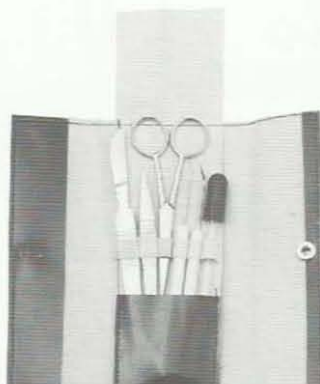

29-211
BASIC DISSECTING SETS
VINYLE POUCH.

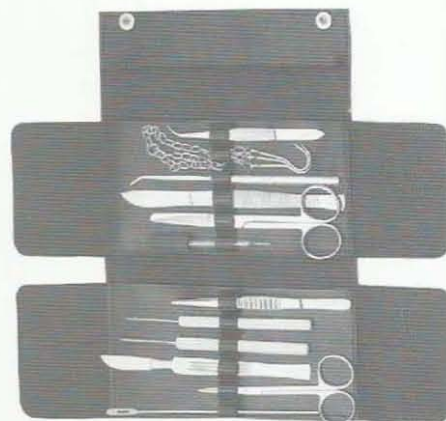

29-212
ANATOMY DISSECTING SET
DOUBLE FOLDING LEATHER CASE.

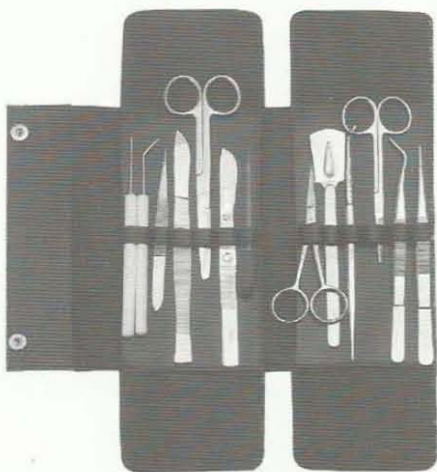

29-213
LARGE ANIMAL SET
DOUBLE FOLDING
LEATHER CASE.



29-214
MICRO DISSECTING SET
DOUBLE FOLDING
LEATHER CASE.

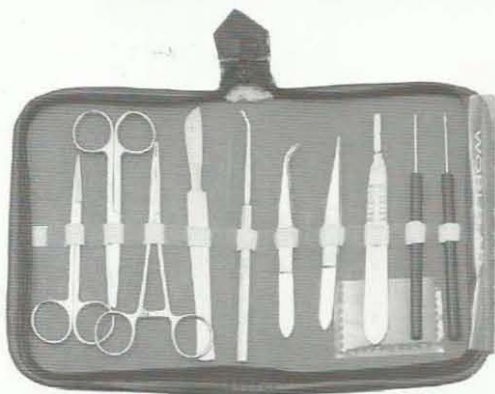

29-215
NEW INSTRUCTORS DISSECTING SET
(Set Of 12)



29-216
BASIC DISSECTING SETS
In Attractive Zipper Case
(set of 9)

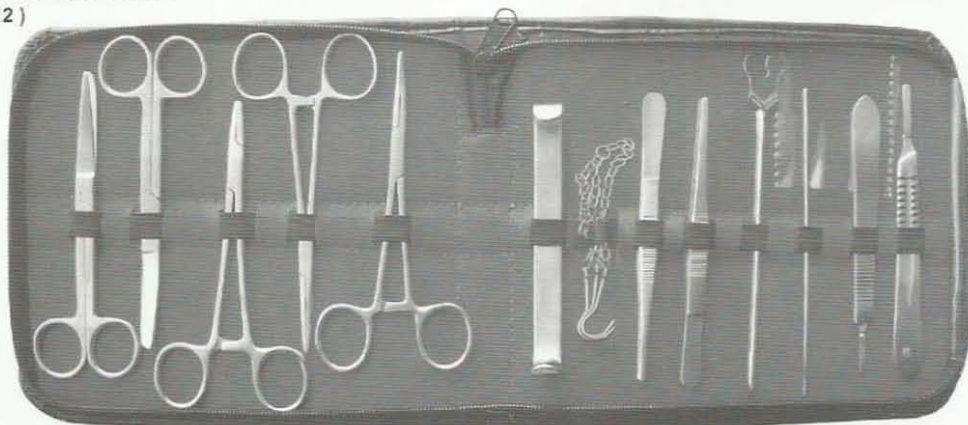

29-217

**TUNGSTEN CARBIDE INSTRUMENTS
FOR THOSE.....
WHO DEMAND SECURITY & ACCURACY.**



Tungsten Carbide Is One Of The Hardest Alloys. We Bond These Inserts Into High Quality German Stainless Steel For Very Special Reasons Of The End Users. We Offer A Wide Range Of Instruments Which Includes Scissors , Forceps And Needle Holders Of All Kinds Made Of German Stainless Steel.

Briefly, We Strive To End Up With Quality, Precision And Conformity To Our Buyers/specification And Standard By All Means. The Process Indeed Involves Complex Machining Operations, Skill And Experience.

Let Us Please Secure Your Attention To Serve You Better.

MANAGEMENT

Instruments with Tungsten Carbide Inserts

TC GOLD

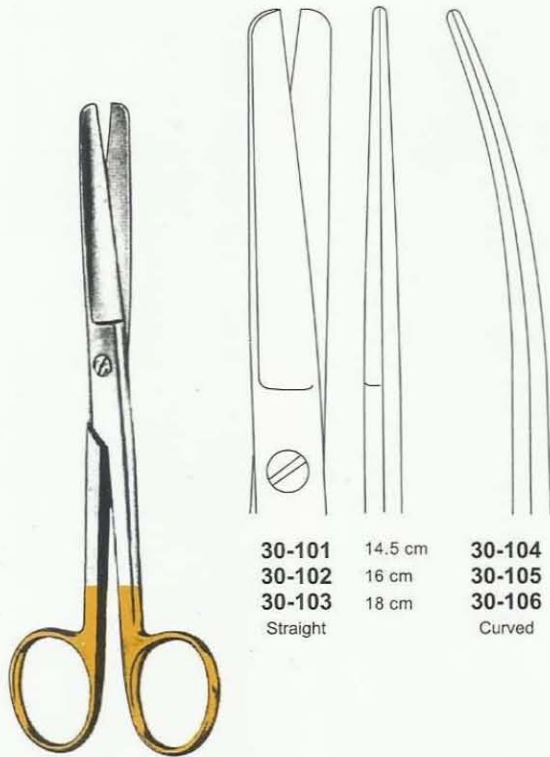

30-101	14.5 cm	30-104
30-102	16 cm	30-105
30-103	18 cm	30-106
Straight		Curved

STANDARD
30-101 to 30-106

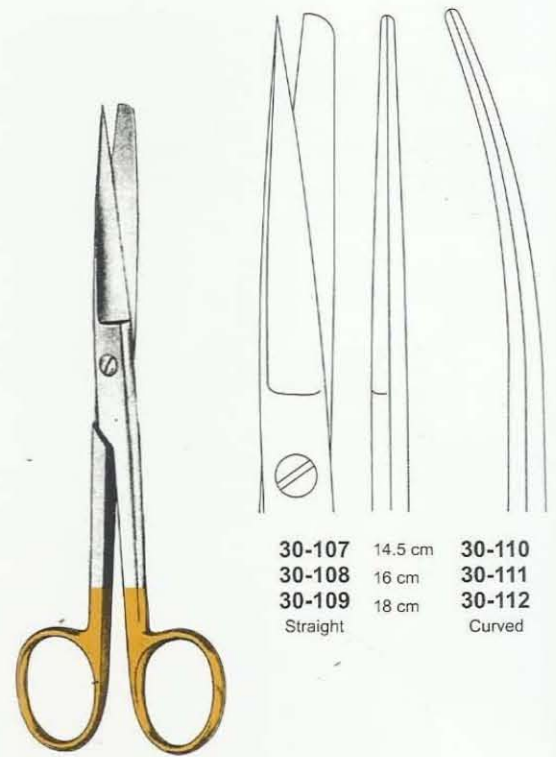

30-107	14.5 cm	30-110
30-108	16 cm	30-111
30-109	18 cm	30-112
Straight		Curved

STANDARD
30-107 to 30-112

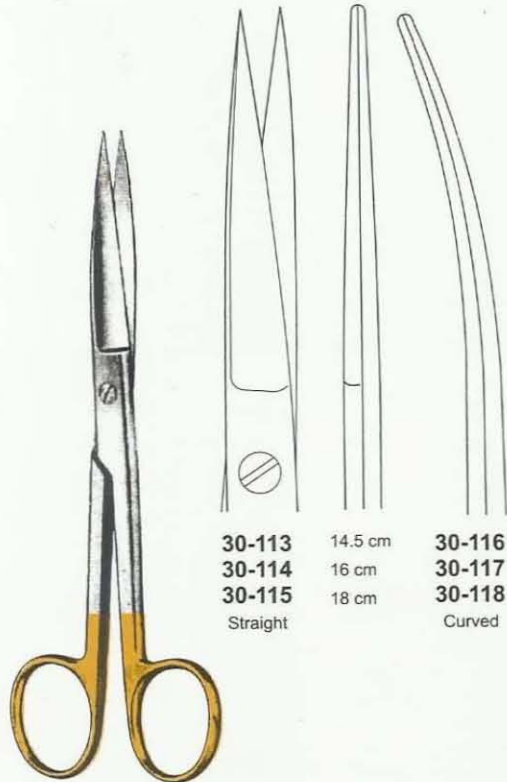

30-113	14.5 cm	30-116
30-114	16 cm	30-117
30-115	18 cm	30-118
Straight		Curved

STANDARD
30-113 to 30-118

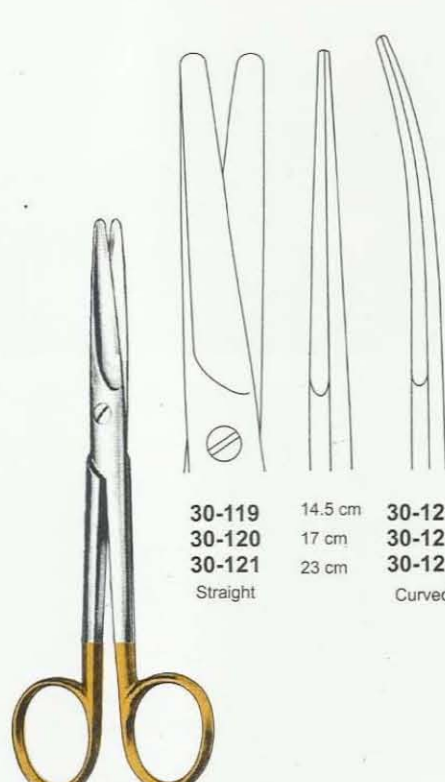

30-119	14.5 cm	30-122
30-120	17 cm	30-123
30-121	23 cm	30-124
Straight		Curved

MAYO
30-119 to 30-124



30-125	14.5 cm	30-126
Straight		Curved

MAYO-LEXER
30-125 to 30-126



Instruments with Tungsten Carbide Inserts

TC GOLD

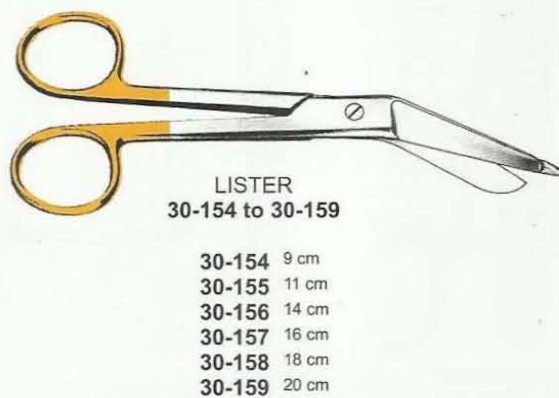

Instruments with Tungsten Carbide Inserts

TC GOLD

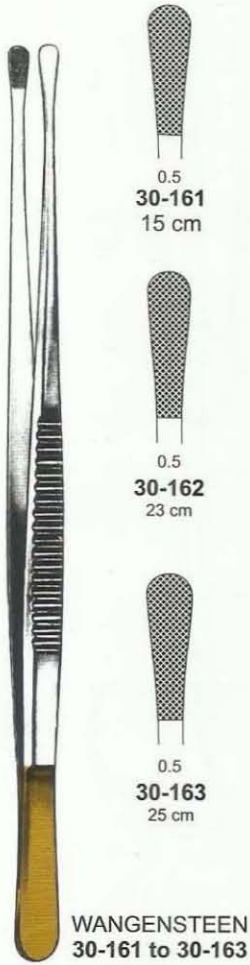

WANGENSTEEN
30-161 to 30-163

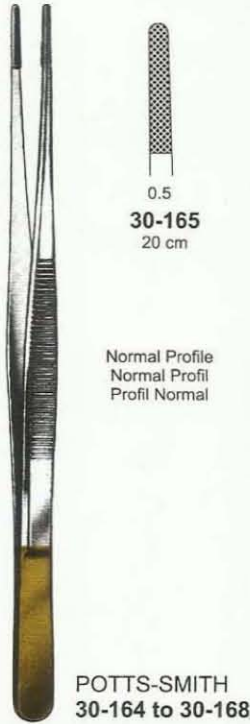

POTTS-SMITH
30-164 to 30-168

Normal Profile
Normal Profil
Profil Normal

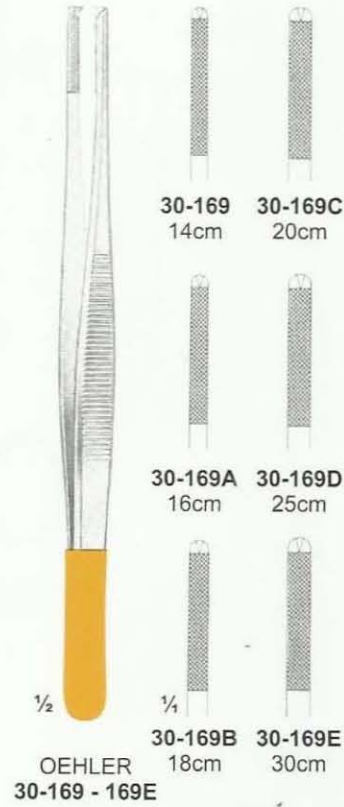

OEHLER
30-169 - 169E



	STANDARD	NARROW
30-170	14.5cm	30-174
30-171	18cm	30-175
30-172	20cm	30-176
30-173	23cm	30-177

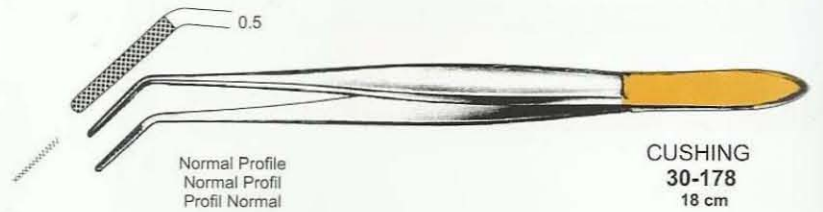

CUSHING
30-178
18 cm

Normal Profile
Normal Profil
Profil Normal

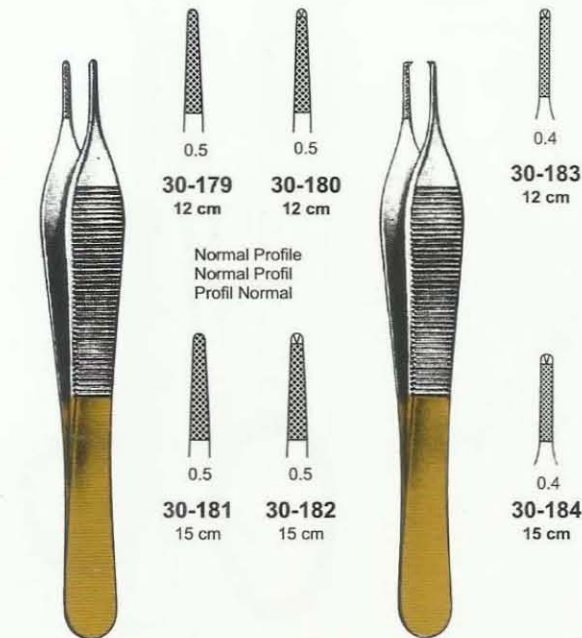

ADSON
30-179 to 30-182



MICRO ADSON
30-183 to 30-184

Normal Profile
Normal Profil
Profil Normal

Micro Profile
Mikro Profil
Profil Micro

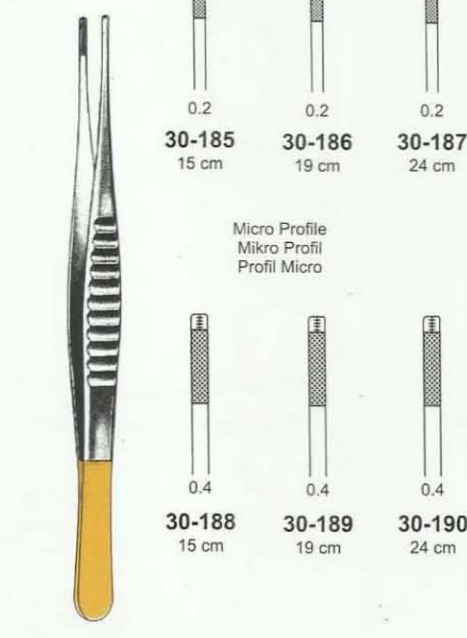

DE BAKY
30-185 to 30-190

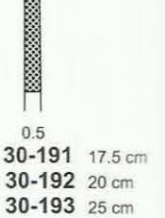

CUSHING
30-191 to 30-193

Normal Profile
Normal Profil
Profil Normal

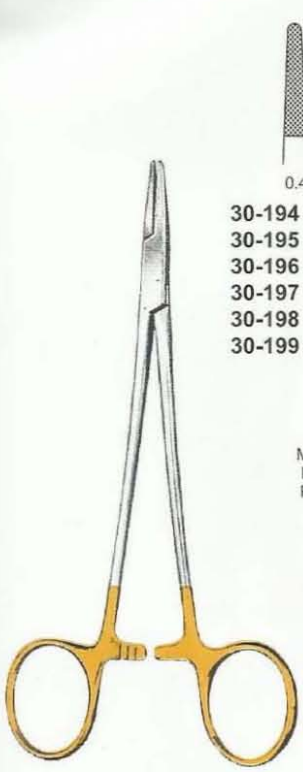

- 30-194 15 cm
- 30-195 18 cm
- 30-196 20 cm
- 30-197 23 cm
- 30-198 25 cm
- 30-199 30 cm

Mini profile
Mini profil
Profil mini

CRILE-WOOD
30-194 to 30-199

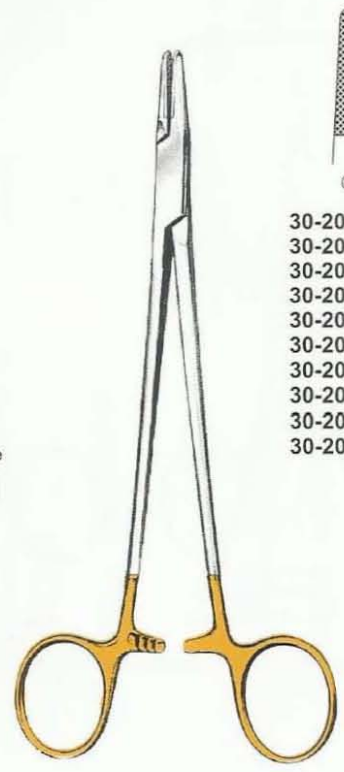

- 30-200 14 cm
- 30-201 16 cm
- 30-202 18 cm
- 30-203 20 cm
- 30-204 24 cm
- 30-205 26 cm
- 30-206 30 cm
- 30-207 35 cm
- 30-208 40 cm
- 30-209 45 cm

MAYO-HEGAR
30-200 to 30-209

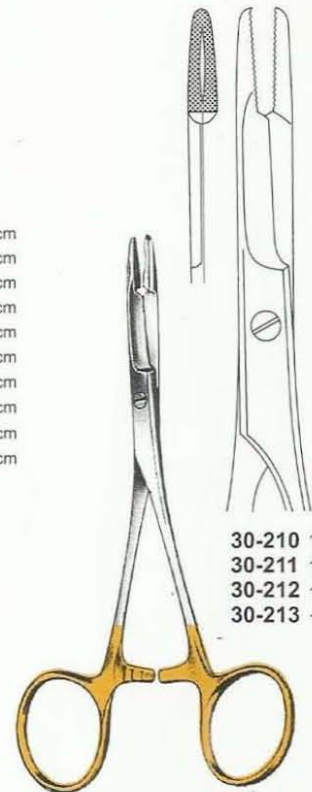

- 30-210 14 cm
- 30-211 16 cm
- 30-212 17 cm
- 30-213 19 cm

OLSEN-HEGAR
30-210 to 30-213

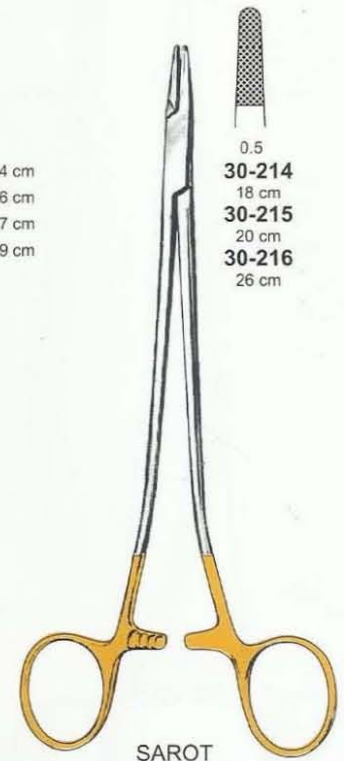

- 30-214 18 cm
- 30-215 20 cm
- 30-216 26 cm

SAROT
30-214 to 30-216

Instruments with Tungsten Carbide Inserts
TC GOLD

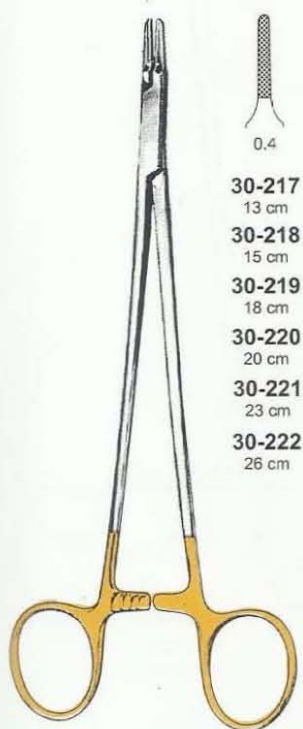

- 30-217 13 cm
- 30-218 15 cm
- 30-219 18 cm
- 30-220 20 cm
- 30-221 23 cm
- 30-222 26 cm

Mini profile
Mini profil
Profil mini

RYDER
30-217 to 30-222

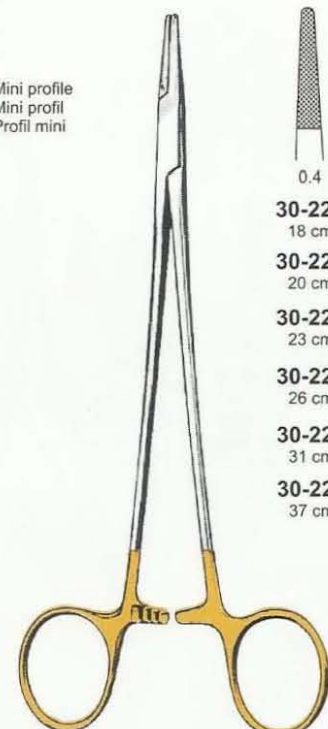

- 30-223 18 cm
- 30-224 20 cm
- 30-225 23 cm
- 30-226 26 cm
- 30-227 31 cm
- 30-228 37 cm

DE BAKEY
30-223 to 30-228

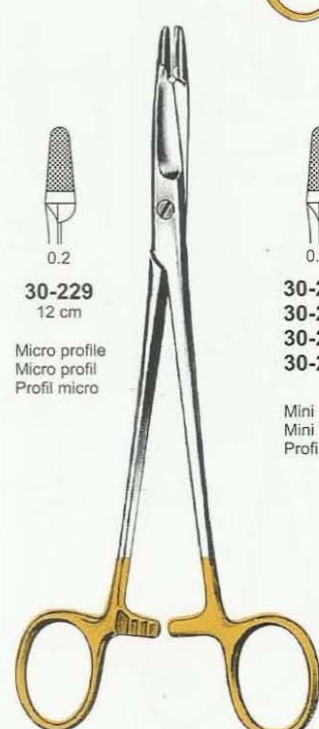

- 30-229 12 cm

Micro profile
Micro profil
Profil micro

OLSEN-HEGAR
30-229 to 30-233

- 30-230 14 cm
- 30-231 16 cm
- 30-232 17 cm
- 30-233 19 cm

Mini profile
Mini profil
Profil mini

Instruments with Tungsten Carbide Inserts

TC GOLD



Masson
86-424
27 cm / 10½"

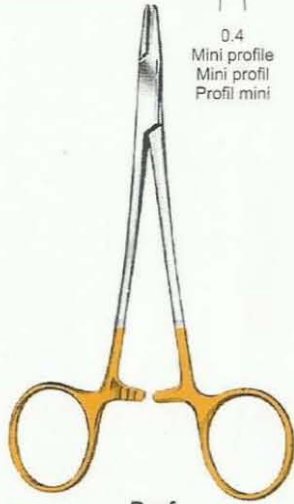

Derf
86-420
12 cm / 4¾"

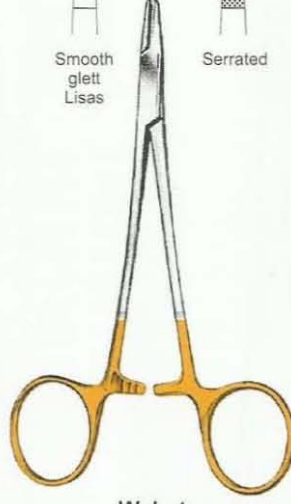

Webster
86-421 Smooth
86-422 Serrated
12 cm / 4¾"

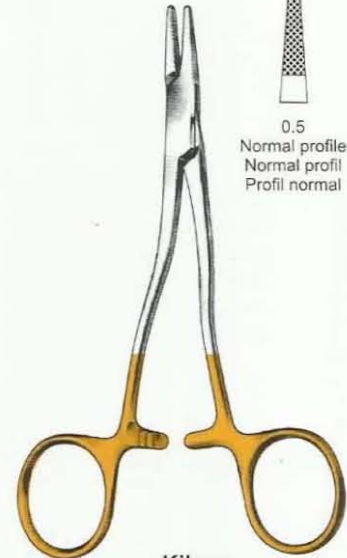

Kilner
86-423
13.5 cm / 5¼"

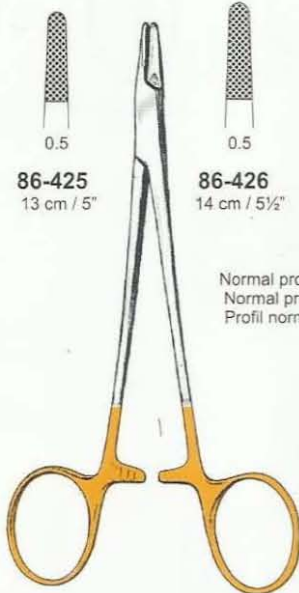

86-425
13 cm / 5"

86-426
14 cm / 5½"

Mini profile
Mini profil
Profil mini

Normal profile
Normal profil
Profil normal

Hegar-Baumgartner
86-425 to 86-426

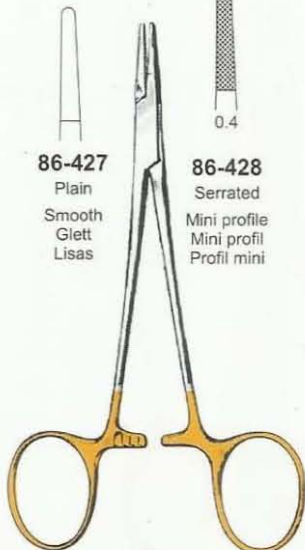

86-427
Plain
Smooth
Glett
Lisas

86-428
Serrated
Mini profile
Mini profil
Profil mini

Halsey
86-427 to 86-428

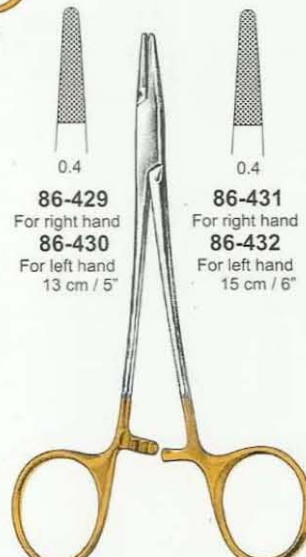

86-429
For right hand
86-430
For left hand
13 cm / 5"

86-431
For right hand
86-432
For left hand
15 cm / 6"

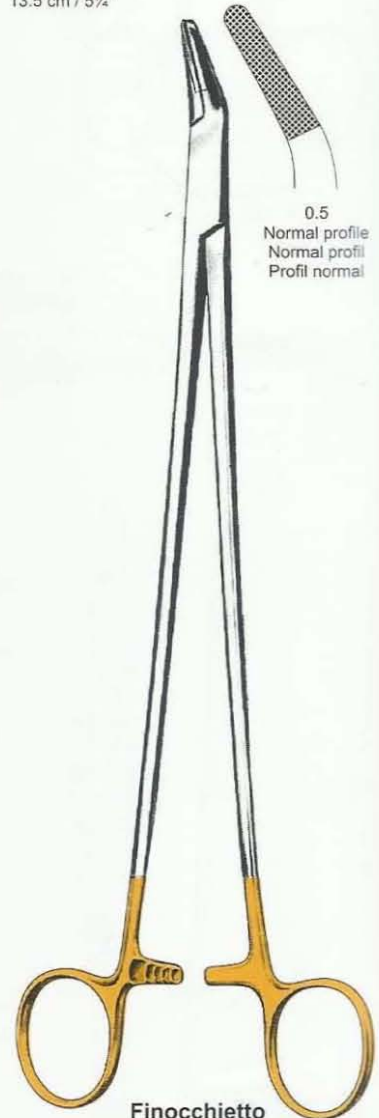

Finocchietto
86-433
27 cm / 10½"

Instruments with Tungsten Carbide Inserts

TC GOLD



Kalt
88-434
13 cm / 5 1/4"
Standard mode
Delicate jaws



Castroviejo
88-435
12 cm / 4 3/4"



Castroviejo Barraquer
88-436
12 cm / 4 3/4"

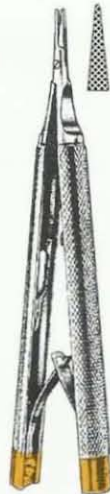

Castroviejo
88-437
13 cm / 5"



88-438 With lock
88-439 Without lock
88-440 With lock
88-441 Without lock

Castroviejo
88-438 to 88-441
9 cm / 3 1/2"

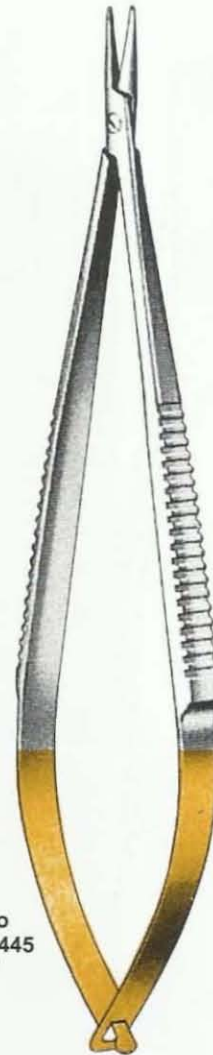

Castroviejo
88-442 to 88-445
13.5 cm / 5 1/2"
Without lock

88-442

88-443

88-444

88-445

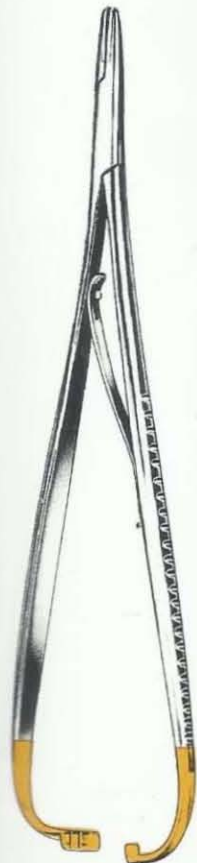

Mathieu
88-446 to 88-448



0.4
88-446
14 cm / 5 1/2"



0.4
88-447
17 cm / 6 3/4"



0.4
88-448
20 cm / 8"

Mini profile
Mini profil
Profil mini

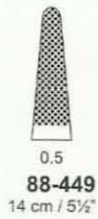

0.5
88-449
14 cm / 5 1/2"



0.5
88-450
17 cm / 6 3/4"



0.5
88-451
20 cm / 8"



Mathieu - Standard
88-449 to 88-451



Mathieu
88-452 to 88-453



0.4
88-452
20 cm / 8"



0.4
88-453
24 cm / 9 3/4"



Lichtenberg
88-454
20 cm / 8"



0.5



Toennis
88-455
18 cm / 7"
Elastic pattern



0.5

Instruments with Tungsten Carbide Inserts

TC GOLD

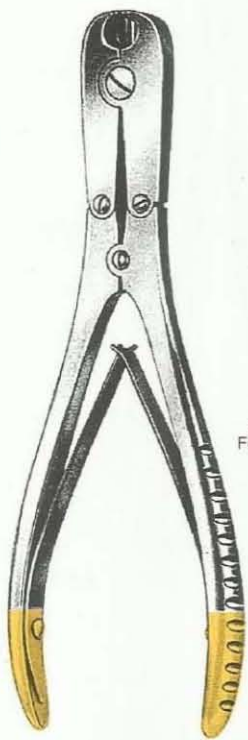

90-456
18 cm / 7"
For soft wires up to 2 mmØ
For hard wires up to 1.5 mmØ

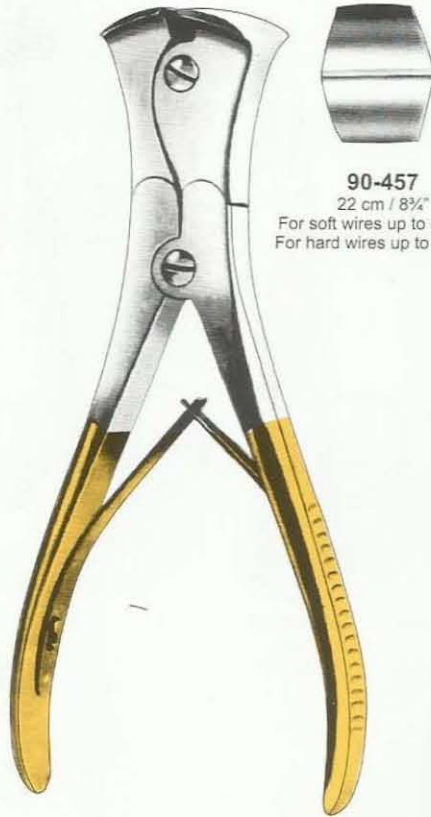

90-457
22 cm / 8 3/4"
For soft wires up to 3.5 mm
For hard wires up to 2.5 mm

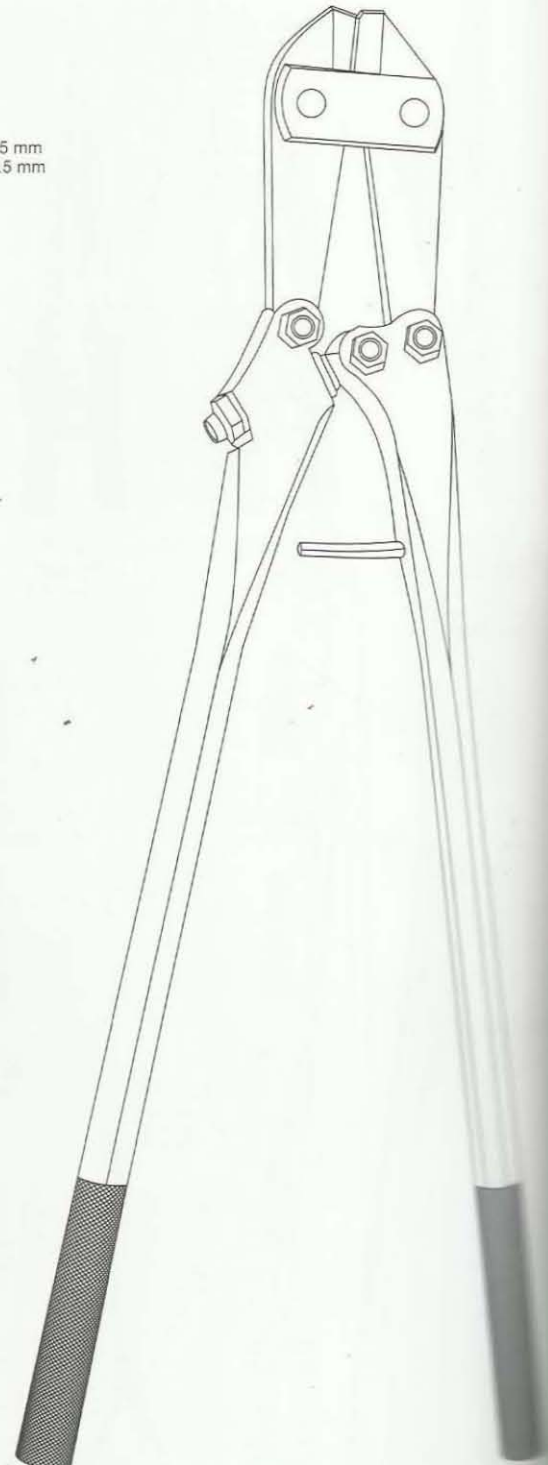

TC wire cutter

		For wire
90-463	38.5 cm / 15"	5 mm
90-464	45 cm / 17 3/4"	6 mm
90-465	56 cm / 22"	7.5 mm

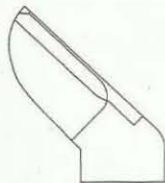
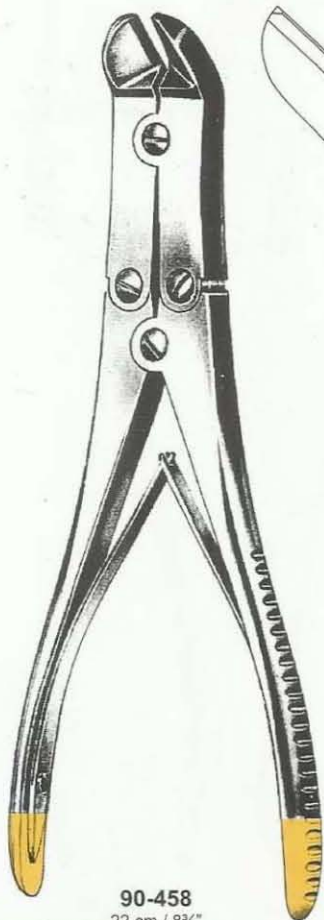

90-458
22 cm / 8 3/4"

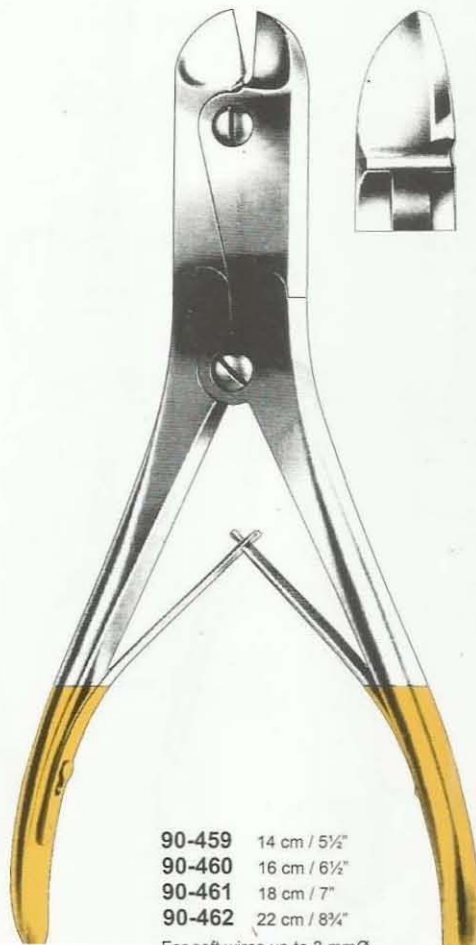

90-459 14 cm / 5 1/2"
90-460 16 cm / 6 1/2"
90-461 18 cm / 7"
90-462 22 cm / 8 3/4"

SECTION PAGE

**Surgical
Holloware**

31

**414
to
424**

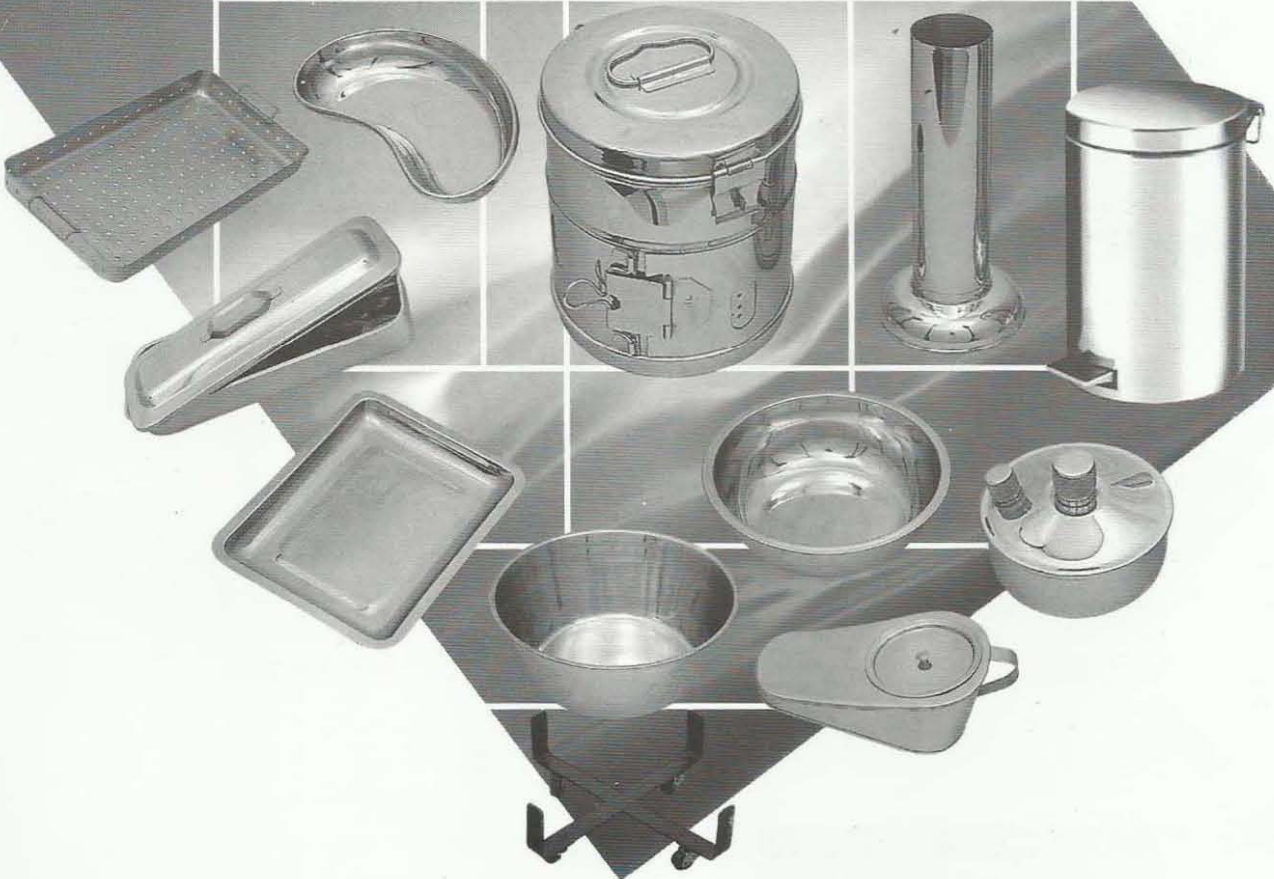

STERILIZER DRUM

ART #	SIZE
31-101	125x80mm
31-102	125x120mm
31-103	150x100mm
31-104	150x150mm
31-105	180x180mm
31-106	190x140mm
31-107	190x190mm
31-108	200x200mm
31-109	240x120mm



31-101 TO 31-118

STERILIZER DRUM

ART #	SIZE
31-110	240x240mm
31-111	290x140mm
31-112	290x240mm
31-113	290x290mm
31-114	340x160mm
31-115	340x340mm
31-116	390x150mm
31-117	390x200mm
31-118	390x290mm



31-119

ELECTRIC STERILIZER

ART #	SIZE
31-119	280x125x65mm

ELECTRIC STERILIZER

ART #	SIZE
31-120	200x100x120mm
31-121	250x120x140mm
31-122	300x150x150mm
31-123	350x170x170mm
31-124	400x200x180mm
31-125	450x230x190mm



31-120 To 31-125

NON ELECTRIC STERILIZER

ART #	SIZE
31-126	200x100x65mm
31-127	250x125x65mm
31-128	300x150x100mm
31-129	350x170x65mm
31-130	400x200x100mm

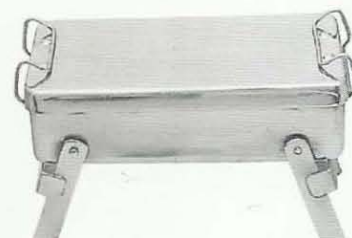

31-126 To 31-130

PERFORATED TRAY

ART #	SIZE
31-131	200x100x40mm
31-132	250x120x50mm
31-133	300x150x50mm
31-134	350x170x50mm
31-135	400x200x50mm

31-131 To 31-135



31-136 To 31-143

INSTRUMENTS TRAY WITHOUT LID

ART #	SIZE
31-136	100x150x25mm
31-137	150x200x40mm
31-138	200x250x45mm
31-139	250x300x50mm
31-140	300x350x50mm
31-141	150x300x50mm
31-142	200x300x50mm
31-143	230x150x50mm

INSTRUMENTS TRAY WITH LID

ART #	SIZE
31-144	100x150x25mm
31-145	150x200x40mm
31-146	200x250x45mm
31-147	250x300x50mm
31-148	300x350x50mm
31-149	150x300x50mm
31-150	200x300x50mm
31-151	230x150x50mm

31-144 To 31-151



31-152 To 31-153

CATHETERS TRAY WITH LID

ART #	SIZE
31-152	300x80x40mm
31-153	350x90x45mm
31-153A	400x100x50mm



31-154

BURR TRAY	
ART #	SIZE
31-154	190x100x20mm



31-155

SCALER TRAY WITH COVER	
ART #	SIZE
31-155	200x100x16mm

INSTRUMENTS BOX WITH HOOKS	
ART #	SIZE
31-156	170x70x30mm
31-157	180x80x40mm
31-158	200x100x40mm
31-159	230x120x50mm
31-160	250x125x50mm
31-161	300x150x50mm
31-162	350x170x50mm
31-163	400x200x90mm
31-164	500x200x120mm



31-156 To 31-164



31-165 To 31-173

INSTRUMENTS BOX	
ART #	SIZE
31-165	170x70x30mm
31-166	180x80x40mm
31-167	200x100x40mm
31-168	230x120x50mm
31-169	250x125x50mm
31-170	300x150x50mm
31-171	350x170x50mm
31-172	400x200x90mm
31-173	500x200x120mm



31-174 To 31-176

INSTRUMENTS BOX PERFORATED	
ART #	SIZE
31-174	200x100x40mm
31-175	250x150x40mm
31-176	300x150x40mm



31-177
To
31-179

Kidney Tray Shallow

ART #	SIZE
31-177	17 cm
31-178	22 cm
31-179	24 cm



31-180
To
31-183

Kidney Tray With Cover

ART #	SIZE
31-180	15 cm
31-181	20 cm
31-182	25 cm
31-183	30 cm



31-184
To
31-190

KIDNEY TRAY

ART #	SIZE
31-184	12 cm
31-185	15 cm
31-186	18 cm
31-187	20 cm
31-188	25 cm
31-189	28 cm
31-190	30 cm

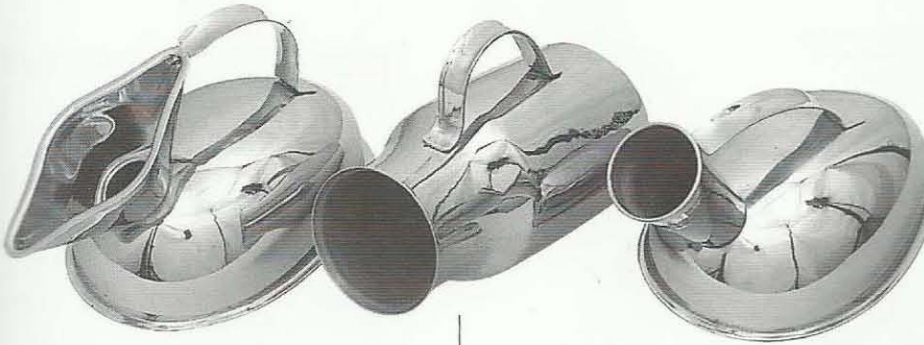

URINAL FEMALE

ART #	SIZE
31-191	STANDARD

URINAL MALE

ART #	SIZE
31-192	STANDARD

URINAL MALE VERTICAL

ART #	SIZE
31-193	Standard



31-194
To
31-195

BEDPAN PERFECTION TYPE

ART #	SIZE
31-194	370x290mm
31-195	320x240mm



31-196

BEDPAN PERFECTION TYPE SEAMLESS

ART #	SIZE
31-196	350x300mm



31-197 To 31-198

BEDPAN SLEEPER TYPE	
ART #	SIZE
31-197	Adult
31-198	Child



31-199 To 31-200

BEDPAN SIMPLE, PRESSED BODY WITH HANDLE	
ART #	SIZE
31-199	Adult
31-200	Child



31-201 To 31-202

BEDPAN HAND MADE	
ART #	SIZE
31-201	Adult
31-202	Child

BEDPAN CHAMBER PORT	
ART #	SIZE
31-203	Standard

31-203

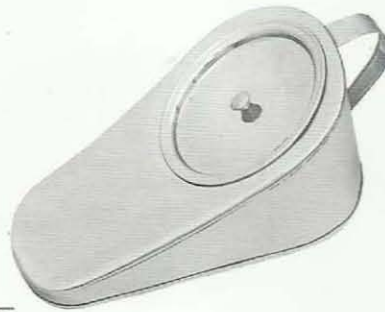

31-204

BEDPAN HAND MADE	
ART #	SIZE
31-204	Standard

BEDPAN HAND MADE	
ART #	SIZE
31-205	Standard

31-205



31-206

BEDPAN PLASTIC MADE	
ART #	SIZE
31-206	Standard

SPONGE BOWL

ART #	SIZE
31-207	12 cm
31-208	15 cm
31-209	20 cm



31-207 To 31-209



31-210 To 31-214

WASH BASIN

ART #	SIZE
31-210	300x80mm
31-211	320x85mm
31-212	330x90mm
31-213	350x110mm
31-214	400x115mm



31-215 To 31-228

Lotion Bowl Without Spout

ART #	SIZE
31-215	40x19mm
31-216	50x25mm
31-217	60x30mm
31-218	80x40mm
31-219	100x50mm
31-220	120x60mm
31-221	140x60mm
31-222	150x65mm
31-223	180x85mm
31-224	200x100mm
31-225	250x120mm
31-226	300mm
31-227	350mm
31-228	400mm



31-229 TO 31-244

GALLIPOT

ART #	SIZE
31-229	01 oz
31-230	02 oz
31-231	03 oz
31-232	04 oz
31-233	05 oz
31-234	06 oz
31-235	07 oz
31-236	08 oz
31-237	09 oz
31-238	10 oz
31-239	11 oz
31-240	12 oz
31-241	13 oz
31-242	14 oz
31-243	15 oz
31-244	16 oz



31-245 To 31-247

MEDICINE CUP

ART #	SIZE
31-245	50ml
31-246	60ml
31-247	70ml



31-248 To 31-250

Pail/bucket With Lid

ART #	SIZE
31-248	06 Ltr
31-249	10 Ltr
31-250	15 Ltr



31-248A To 31-250D

Pail/bucket Without Lid

ART #	SIZE
31-248A	06 Ltr
31-248B	10 Ltr
31-248C	15 Ltr
31-248D	20 Ltr



31-251 To 31-254

MEASURING JUG

ART #	SIZE
31-251	0.5 Ltr
31-252	1.0 Ltr
31-253	1.5 Ltr
31-254	2.0 Ltr



31-255 TO 31-256

KICK BUCKET WITH TROLLEY

ART #	SIZE
31-255	390x280x180mm
31-256	Only Trolley



31-256



31-257 To 31-259

Douch Can / Irrigator

ART #	SIZE
31-257	1.0 Ltr
31-258	1.5 Ltr
31-259	2.0 Ltr



31-260 To 31-266

DRESSING JAR

ART #	SIZE
31-260	80x60mm
31-261	80x80mm
31-262	100x100mm
31-263	120x120mm
31-264	150x150mm
31-265	180x180mm
31-266	200x200mm



31-267 To 31-273

DRESSING JAR

ART #	SIZE
31-267	80x60mm
31-268	80x80mm
31-269	100x100mm
31-270	120x120mm
31-271	150x150mm
31-272	180x180mm
31-273	200x200mm

FORCEPS JAR

ART #	SIZE
31-274	30x90mm
31-275	50x125mm
31-276	50x170mm
31-277	50x200mm
31-278	40x230mm
31-279	70x110mm
31-280	80x150mm
31-281	100x200mm
31-282	150x30mm



31-274 To 31-282

FENNLE

ART #	SIZE
31-283	Ø 100mm
31-284	Ø 120mm
31-285	Ø 150mm
31-286	Ø 200mm

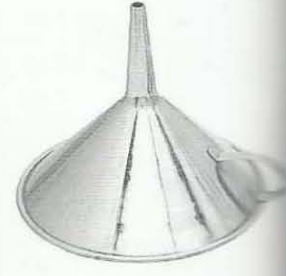

31-283 To 31-286



SPRIT LAMP DOUBLE NOT

ART #	SIZE



SPRIT LAMP SINGLE NOT

ART #	SIZE



31-289 To 31-290

SPUTUM CUP

ART #	SIZE
31-289	100x50mm
31-290	100x50mm

ENDODONTIC BOX	
ART #	SIZE
31-292	100x40x50mm

31-292

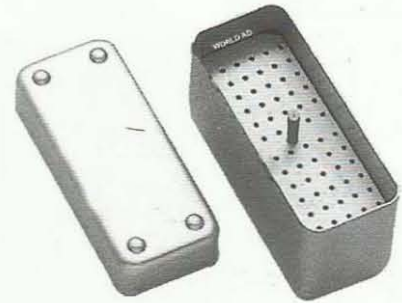

31-293

COTTON HOLDER	
ART #	SIZE
31-293	

TUBE RACK	
ART #	SIZE
31-294	6.35x15.25x5cm for 12 Tubes
31-295	6.35x17.75x7.5cm for 27 Tubes
31-296	7.5x17.75x6.35cm for 36 Tubes

31-294 To 31-296

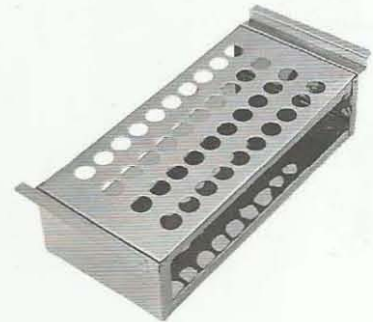

Needle Case Round with Cover

ART #	SIZE



NEEDLE CASE ROUND

ART #	SIZE



NEEDLE CASE RECTANGLE

ART #	SIZE

DUSTBIN	
ART #	SIZE
31-300	210mm
31-301	240mm
31-302	270mm
31-303	300mm

31-300 To 31-303



DUSTBIN WITH STAND	
ART #	SIZE
31-303A	STANDARD

31-303A



31-303B

AUTOCLAVE PROCESSOR COOKER	
ART #	SIZE
31-303B	STANDARD

WIRE MESH TRAY	
ART #	SIZE
31-304	240x250x5mm
31-305	480x250x5mm
31-306	550x250x5mm
31-307	240x250x7mm
31-308	480x250x7mm
31-309	240x250x10mm
31-310	480x250x10mm

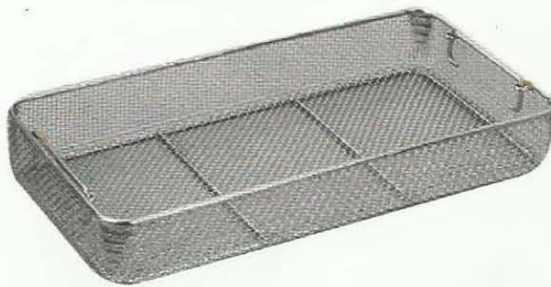

31-304 To 31-310

WIRE MESH TRAY WITH LID	
ART #	SIZE
31-311	240x250x5mm
31-312	480x250x5mm
31-313	550x250x5mm
31-314	240x250x7mm
31-315	480x250x7mm
31-316	240x250x10mm

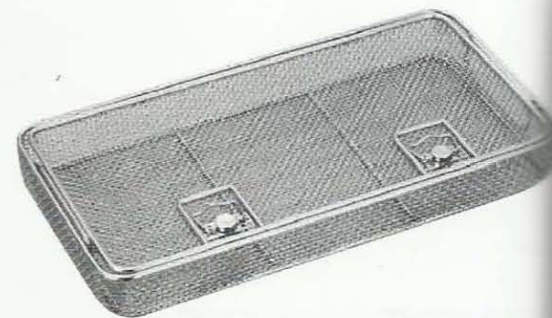

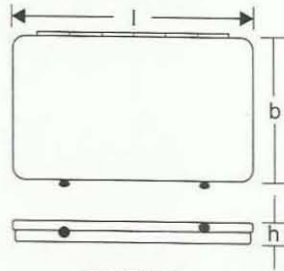

sizes in mm
l x b x h

Sterilization Storage Needle Sterilizing Cases



31-218
Sauerbruch
210 x 125 x 17 mm
perforated lid and
bottom



31-219
Sauerbruch
210 x 125 x 17 mm
perforated lid and
bottom



31-220
150 x 95 x 13 mm



31-221
150 x 95 x 13 mm
perforated lid and
bottom

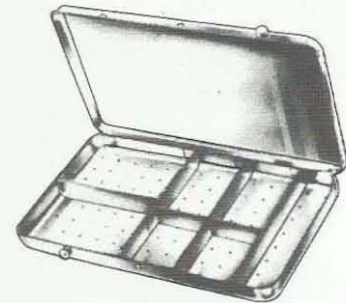

31-222
150 x 95 x 13 mm
perforated bottom



31-223
150 x 95 x 13 mm
perforated lid and



31-224
150 x 95 x 13 mm



31-225
150 x 95 x 13 mm
perforated lid and

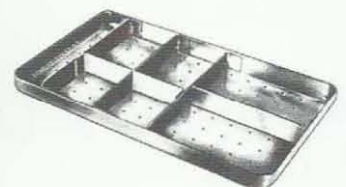

31-226
150 x 95 x 11 mm
Needle tray perforated



31-227 - 230

Sterilizing Trays of wire mesh
for container 60cm long.

31-227	250 x 250 x 50	mm
31-228	480 x 250 x 50	mm
31-229	520 x 250 x 75	mm
31-230	520 x 250 x 100	mm



31-231- 236

Sterilizing Tray Of Perforated
Steel Sheet

31-231	240 x 240 x 50	mm
31-232	240 x 240 x 80	mm
31-233	240 x 240 x 100	mm
31-234	480 x 260 x 50	mm
31-235	520 x 260 x 80	mm
31-236	520 x 260 x 100	mm

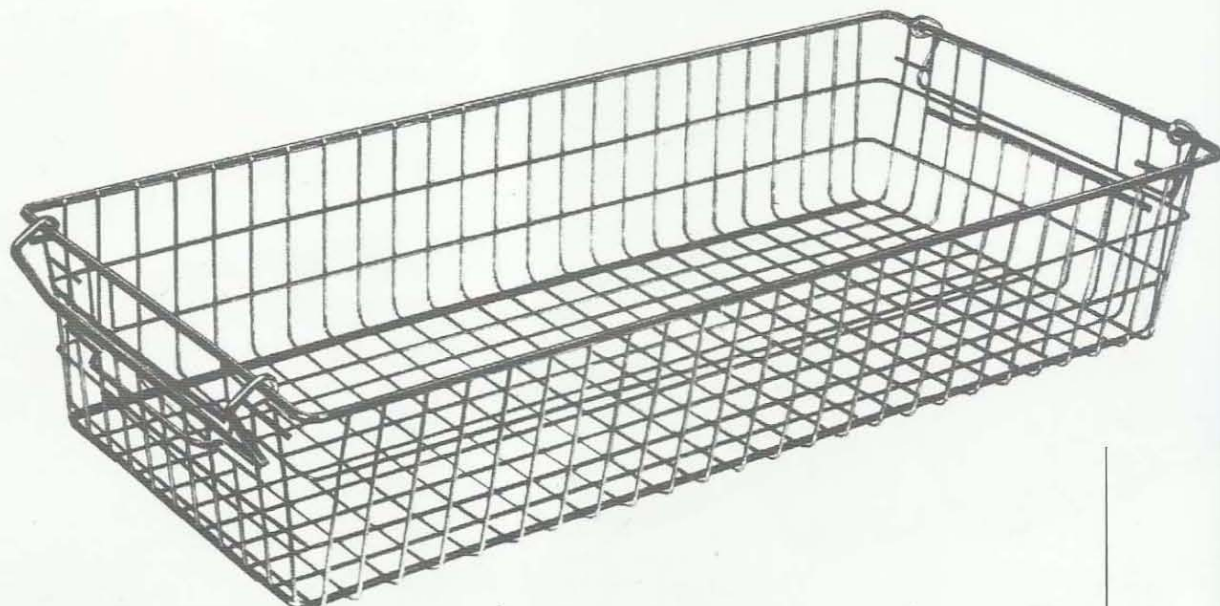

31-237 60 x 30 x 15 cm

ALPHABETICAL

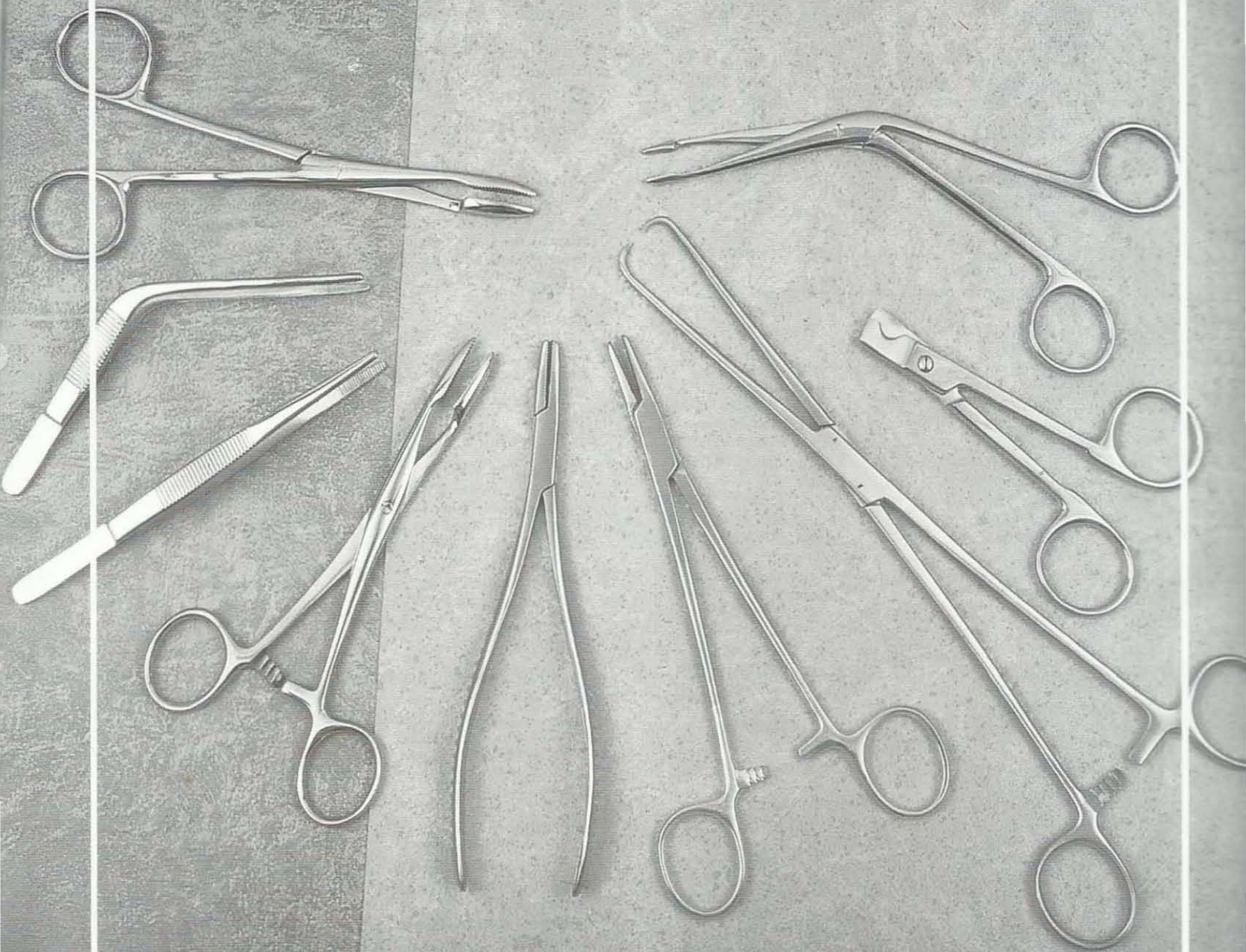

INDEX

A

Abdominal Blades	163
Retractors	144-147, 162-167
Abraham Tonsil Knife	17
Adson Delicate Haemostatic Forceps	80
Dissecting Forceps	55,62,411
Needle Holders	98
Raspatories	334
Retractors	155-156
Adson-Baby Self-Retaining Retractors	154
Adson-Brown Tissue Forceps	63
Aesthesiometers	1
Alexander Bone Rongeurs	367
Gouges	353
Rib Raspatories	299
ALM Organ Grasping Forceps	74
Retractors	151
Sponge Forceps	68
Allen Intestinal Clamps	173
Allis Artery Traction Forceps	73
Intestinal Grasping Forceps	171
Lung Grasping Forceps	290
Tissue Grasping Forceps	168
Allison Lung Spatulas	138,309
ALY Aesthesiometers	1
Amputation Knives	16,319
Retractors	320
Saws	321-322
Anastomosis Clamps	184-186,265-266, 269-270,275-276, 285-286,293
Anderson-Adson Retractors	155
Andrew Tongue Depressors	5
Anestophon Stethoscope	2
Angle Wire Cutters	388
Antrum Trocars	208
Anusopes	189
Aorta Clamps	280-281,288
Aorta-Anastomosis Clamps	282
Aorta-Aneurysm Clamps	278-279
Aorta Cross Clamps	276-277
Aortic Dilators	260
Appendectomy Clamps	182
Apprex Elevating Forceps	235
Arruga Forceps	62
Needle Holders	96,412,413
Artery Traction Forceps	73
Asch Secretion Curette/Scoop	237
Aspiration Curettes	398
Ateriectomy Scissors	34
Aufricht Bone Rasps	339
Austin Micro Forceps	52
Autopsy Knives	13,16
Auricle Clamps	294
Auvard Vaginal Speculums	218
Ayre Cone Knife	17

B

Babcock Intestinal Grasping Forceps	169,171
Lung Grasping Forceps	290
Baby-Adson Forceps	87
Baby-Allis Artery Traction Forceps	73
Baby-Allis Tissue Grasping Forceps	168
Baby-Collin Abdominal Retractors	162
Baby-Crile Delicate Haemostatic Forceps	80
Baby-Kocher Intestinal Clamps	173
Baby-Metzenbaum Scissors	38
Baby-Mikulicz Peritoneum Forceps	91
Baby-Mixer Forceps	87
Baby-Mosquito (Hartmann) Haemostatic Forceps	79

Baby-Nail Scissors	49
Baby-Overholt Forceps	87
Baby-Roux Retractors	123
Baby-Senn-Miller Retractors	123
Backhaus Towel Clamps	75
Backhaus-Kocher Towel Clamps	75
Bailey Rib Spreaders and Contractors	307
Bainbridge Intestinal Clamps	173
Bakes Common Bile Duct Dilators	198
Balfour Abdominal Retractors	165
Balfour-Baby Abdominal Retractors	164
Bandage Cutting Scissors	49-51,393,394
Bane-Hartmann Bone Rongeurs	366
Barraquer Micro Needle Holders	97,419
Retractors	151
Barth Bone Curettes	342
Bayonet Shaped Forceps	53-54,61
Bumgartner Needle Holders	98
Beckmann-Adson Retractors	156
Beckmann-Eaton Retractors	156
Beebe Wire and Plate Scissors	48
Beer Cilia Forceps	66
Bed Pans	417-18
Bending Pliers	387
Bengolea Delicate Haemostatic Forceps	81
Bennett Bone Levers	330
Berger Biopsy Forceps	240
Bergh Cilia Forceps	66
Bergmann Mallets	350
Plaster Scissors	394
Trachea Retractors	118
Berliner Percussion Hammer	1
Bertillon Caliper for Head	11
Bethune Rib Shears	296
Beyer Bone Rongeurs	367
Biemer Curettes for Aspiration Lipectomy	398
Vein Scissors	24
Bier Amputation Saws	322
Bircher Meniscus and Cartilage Forceps	377
Bircher-Ganske Meniscus & Cartilage Forceps	377
Biopsy Curettes	237
Forceps	238-240
Forceps For Rectum	190-191
Biopsy Instruments	237-240
Tips	240
Bioptome	260
Bishop-Harmon Forceps	62
Blade Breakers	19
Bladder Retractors	204
Spatula	204
Blake Embolus Grasping Forceps	257
Gall Stone Dilators	198
Gall Stone Forceps	199
Uterine Curettes	242
Blood Lancet	7
Blumenthal Bone Rongeurs	366
Bohler Bone Cutting Forceps	374
Bone Rongeurs	368
Traction Bows	382
Bonaccolto Forceps	55
Bone Clamps	364
Curettes	342-347
Cutting Forceps	297,373-376
Files	399-341
Holding Forceps	358-363
Levers	324-330
Rasps	339-341
Retractors	125
Rongeurs	365-372
Shears	42
Bonney Dissecting Forceps	58
Tissue Forceps	65
Bose Self-Retaining Retractors	151

Bose Trachea Retractors	118
Tracheal Hooks	256
Bowel Scissors	46
Bowles Stethoscopes	2
Bowman Probes	109
Boynton Needle Holders	101
Boys-Allis Artery Traction Forceps	73,168
Bozemann Uterine Dressing Forceps	225,226
Uterine Scissors	44
Vaginal Speculums	219
Bozemann-Douglas Uterine Dressing Forceps	226
Bozemann-Fritsch Uterine Flushing Tube	245
Brain Knives	13
Braun Artery Traction Forceps	73
Cranioclast	254
Tenaculum Forceps	227
Uterine Depressor	224
Vaginal Speculums	215
Braun-Stadler Scissors	45,51,248
Breisky Pelvimeter	246
Vaginal Speculums	211,217
Brock Micro Needle Holders	97
Brodie Director	107
Brom Vein Hook	115
Bronchus Clamps	277
Forceps	295
Brophy Dissecting Forceps	56
Tissue Forceps	64
Brown Forceps	63
Bruenings Extension Cannulae	240
Tongue Depressor	5
Tonsil Knife	17
Brunner Guiding Probes	105,106
Ligature Needles	105
Retractors	137
Rib Shears	296
Bruns Bandage and Plaster Scissors	51,394
Bone Curettes	344
Bryant Sponge Forceps	67
Buchs Retractors	130
Buchwald Tongue Depressors	5
Buck Cotton Applicators	110
Percussion Hammer	1
Buck-Gramcko Bone Levers	325
Buelau Empyema Trocars	208
Bulldog Clamps	77,78
Bumm Ovum Curettes	243
Ovum Forceps	232
Uterine Curettes	242
Bunt Safety Pin	76
Bushe Bone Curettes	345

C

Calipers	11
Canad.Modell Meniscus Knives	379
Cardiovascular Scissors	40
Caroll Caliper	11
Carotid Clamps	294
Carrel Delicate Haemostatic Forceps	79
Cartilage Forceps	377
Knives	13,16
Caspar Bone Curettes	346
Knot tier and Ligature Adjuster	106
Micro Scissors	24
Nerve and Vessel Hooks	116
Raspatories	335
Retractors	130,160
Rongeurs	314-316,318
Tampers	351

Castroviejo Blade Holder	19
Caliper	11
Micro Spring Scissors	23
Needle Holders	96,412
Tissue Forceps	62
Castroviejo-Koshima Needle Holders	412
Castroviejo-Micro Needle Holders	412
Catlin Knife	16
Cerclage Instruments	384
Wire Tightner	383
Chaput Artery Traction Forceps	73,168
Charging Set	4
Charriere Amputation Saws	321,322
Cheate Forceps with Jar	423
Cheek and Lip Retractors	5
Cheron Sponge Forceps	69
Chisels	351-353,355,356
Choledochus Forceps	195
Cilia Forceps	66
Circumcision Clamps	207
Citelli Punches	310
Citelli-Beyer Punches	310
Clar Head Light	4
Claus Van Eicken Needle	104
Cleaning Brush	256
Clip Applying and Removing Forceps	111
Clip Applying Forceps	111
Cloth Scissors	50,51
Cloward Lamina Spreader	161
Retractors	159
Coagulation Hooks	116
Suction Cannulae	404
Coakley Antrum Trocars	208
Coarctation Clamps	272,273,288
Collin Abdominal Retractor	162
Clip Applying Forceps	111
Druck Pressure	11
Elevating Forceps	233,235
Intestinal Grasping Forceps	169,171
Kidney Elevating Forceps	202
Organ and Tissue Grasping Forceps	71
Ovum Curettes	243
Pelvimeters	246
Retractors	123
Rib Shears	296
Scalpel Handle	20
Sponge Forceps	69,71
Tongue Forceps	6
Vaginal Speculums	209
Collin-Hartmann Retractors	123
Combined Suction and Irrigation Cannulae	404
Comedone Extractors	18
Compression Forceps	94-95
Conductors	323
Cone Knife	17
Contractors	307
Converse Dura and Skin Retractor	117
Needle Holder	98
Cooley Aortic Dilators	260
Clamps	284-288
Multi Purpose Clamps	266,287
Sternotomy Spreaders	305
Cooley-Beck Anastomosis Clamps	284
Cooper Surgical Scissors	31
Ligature Needle	104
Coronary Artery Scissors	39
Cottle Bulldog Scissors	33
Chisels	353
Forceps	61
Mallets	348
Nasal Scissors	41
Osteotomes	353

ALPHABETICAL INDEX

Retractors	122
Wound Retractors	117
Cotton Applicators	109,110,224
Crafoord Auricle Clamps	294
Delicate Haemostatic Forceps	81
Crafoord-Sellers Auricle Clamps	294
Cranioclast	254
Crile Delicate Forceps	80
Needle Holders	100
Nerve and Vessel Hook	115
Retractors	123
Crile-Murray Needle Holders	98
Crile-Wood Needle Holders	98
Cusco Vaginal Speculums	209,210
Cushing Dissecting Forceps	56,409
Nerve and Vessel Hooks	115,116
Retractors	122
Rongeurs	316
Cushing-Kocher Retractors	122
Cushing-Taylor Forceps Bayonet	409
Czerny Gall Stone Forceps	199
Retractors	124
Tenaculum Forceps	229

D

Dandy Delicate Forceps	79
Dardik Multi Purpose Clamps	289
Dartigues Elevating Forceps	233
Kidney Elevating Forceps	202
Daubenspeck Bone Curettes	345
Davidson Scapula Retractors	139,308
Davis Vascular Spatulas	258
De Bakey Anastomosis Clamps	186
Aorta Clamps	281
Aorta-Aneurysm Clamps	278,279
Ateriotomy Scissors	34
Bulldog Clamps	78
Clamps	264-283
Coarctation Clamps	272,273
Dissecting Forceps	263
Forceps (Full range)	60,172,263
Multi Purpose Clamps	266,283
Needle Holders	409
Offset Scissors	39
Patent-Ductus Clamps	273
Peripheral-Vascular Clamps	274,275
Retractors	157
Rib Spreaders	303
Ring Handle Bulldog Clamps	264
Suction Cannulae	309,401
Tangential Occlusion Clamps	271,272
Vascular Clamps	274,275
Vascular Dilators	257
Vessel Scissors	39
De Bakey-Beck Vena Cava Clamps	270
De Bakey-Bainbridge Atraumata Haemostatic Forceps	267
De Bakey-Harken Vena Cava Clamps	271
De Bakey-Hess Bulldog Clamps	77
De Bakey-Kelly Atraumata Haemostatic Forceps	268
De Bakey-Mixter Dissecting & Ligature Forceps	269
De Bakey-Pean Atraumata Haemostatic Forceps	268
De Bakey-Satinsky Tangential Occlusion Clamps	272
De Lee Pelvimeter	246
Dean Tonsil Scissors	41
Deaver Retractors	139-143
Surgical Scissors (Flat Lock)	32
Dejerine Percussion Hammer	1
Delicate Dissecting Forceps	55-56
Haemostatic Forceps	79-81
Scissors	26-29,33,41
Tissue Forceps	62

Demel Wire Guide	384
Denhardt Mouth Gag	6
Denis Browne Intestinal Forceps	65,170
Derf Needle Holders	98
Dermotomes	22
Derra Multi Purpose Clamps	266
Derra-Cooley Anastomosis Clamps	285
Deschamps Ligature Needles	103,104
Desjardins Forceps	90,194
Gall Duct Probes	197
Gall Stone Forceps	199
Gall Stone Probes	198
Desmarres Retractors	122
Diagnostic Sets	8
Dick Anastomosis Clamps	184,276
Atraumata Compression Clamps	94
Dieffenbach Bulldog Clamps	77
Scalpels	14
Diethrich Aorta Clamps	280
..... Scissors	39
Dilators	256,257
Dingmann Bone Holding Forceps	358
Directors Probes	107
Distractors	382
Dissecting Forceps	57,58,87-90,
.....	263,269,291,
.....	292
Dissecting SETS	406
.....Knives	12
.....Scissors	33-38,409
Dittel Gall Duct Dilators	198
Urethral Bougies	206
Doyen Gall Bladder Forceps	196
Intestinal Clamps	174-176
Myoma Screws	236
Needle Holder	98
Ovum Forceps	232
Directors	107
Raspatories	298,337
Retractors	146-147
Towel Clamps	75
Vaginal Speculums	216,217
Doyen-Child Fixation Device	147
Dressing Forceps	67-71
Sterilizing Drums	412
Drilling Chucks	383
Duplay Sponge Forceps	67
Tenaculum Forceps	228
Durogrip Bone Rasps	340
Wire Holding Forceps	386
Durotip Angle Wire Cutters	388
Wire Cutting Pliers	389,391
Wire Cutting Scissors	388
Dura Knives	18
Retractors	117
Scissors	40
Duval Intestinal Forceps	65,169
Intestinal Grasping Forceps	170
Lung Grasping Forceps	290
Duval-Collin Intestinal Grasping Forceps	169

E

Ear Specula	07
Echlin Bone Rongeurs	369
Eiselsberg Ligature Scissors	47
Needle Holders	100
Eiselsberg-Mathieu Needle Holder	101
Elevators	258,299,324,
.....	331-336
Elsching Forceps	62
Embolus Grasping Forceps	257
Emmet Fistula Hooks	121
Sponge and Dressing Forceps	69

ALPHABETICAL INDEX

Empyema Trocars	208
Enderectomy Strippers	259
Endospecula For Cervix	223
Engel Plaster Saw	393
Engl. Mod. Towel Clamps	75
Enucleation Scissors	35
Episiotomy Scissors	45,248
Eppendorf Biopsy Forceps	240
Esmarch Bandage & Plaster Scissors	51,394
Plaster Knife	393
Ether Mask	6
Examination and Measuring Instruments	11
Exploration Hooks	116
Extension Cannulae	240
Cord	4
Extraction Pliers	387
Eye Scissors	23

F

Farabeuf Bone Holding Forceps	360
Raspatories	336
Retractors	123
Farabeuf-Lambotte Bone Holding Forceps	360
Farrell Cotton Applicators	109,110
Faure Biopsy Forceps	238
Peritoneum Forceps	91
Favoloro Artery Scissors	39
Feilchenfeld Splinter Forceps	66
Female Catheters Urinary Instruments	206
Femur Retractor	157
Fergusson Bone Holding Forceps	359
Haemorrhoidal Forceps	193
Suction Tube	402
Fergusson-Ackland Mouth Gag	6
Ferris-Smith-Kerrison Punches	312
Fiber Optic Batery Handle	10
Fine Scissors	27,33,34,410
Finger Nail Drill	392
Nail Instruments	392
Ring Saw	392
Finochietto Dissecting & Ligature Forceps	89,291
Needle Holders	411
Rib Spreaders	300,301
Finochietto-Burford Rib Spreaders	302
Finsen Self-Retaining Retractors	151,256
Finsterer Combined Cannulae	404
Fishtail Chisel	353
Fistula Hooks	121
Fixation Clamp	380
Discs	381
Flap Knives	16
Flat Nosed Pliers	386,387
Foerster-Ballenger Sponge Holding Forceps	70
Fomon Dissecting Scissors	35
Forceps	60-61
Nasal Scissors	41
Rasps/Bone File	340
Retractors	120
Forceps	52-66
With Tungsten Carbide Inserts	411-412
Ford-Bowles Stethoscopes	2
Foregger Laryngoscopes	10
Fowler Tonsil Knife	17
Francke Blood Lancet	7
Frazier Fine Wound Retractors	117
Suction Tube	402
Freer Chisels	351
Fine Wound Retractors	117
Gouges	351
Raspatories	332,333
Vascular Spatulas	258
Freer-Yasargil Raspatories	333

Frenzel Tongue Depressors	5
Fricke Artery Forceps	58,82
Fritsch Retractors	146

G

Gall Bladder Forceps	196
Trocars	208
Gall Duct Dilators	198
Forceps	194-195
Probes	197
Scissors	196
Gall Stone Forceps	199
Scopes	198
Gallaher Bone File	339
Gastro-Intestinal Forceps	181
Gauss Scalp Flap Forceps	251
Gelpi Retractors	157
Vaginal Retractors	220
Genito-Urinary Instruments	205-207
Gerald Dissecting Forceps	56
Tissue Forceps	64
Gerster Bone Clamps	364
Gierzt-Stille Rib Shears	269
Gigli Wire Saws and Handle	323
Gill Forceps	62
Gill-Hess Forceps	62
Gillies Fine Wound Retractors	117
Needle Holders	100
Tissue Forceps	64
Glass Rods	236
Glover Anastomosis Clamps	269,270
Bulldog Clamps	78
Vana Cava Clamps	270
Gluck Rib Shears	296
Good Tonsil Scissors	41
Gorney Suction Dissector	402
Gosset Abdominal Retractors	164
Gouges	351-353,355-356
Graefe Fine Wound Retractors	117
Knives	14
Nerve and Vessel Hooks	115
Tissue Forceps	63
Grave Vaginal Speculums	211
Gray Forceps	90,195
Green-Armytage Obstetrics Forceps	251
Gross Sponge Forceps	67
Gruenwald Forceps	61
Guedel-Negus Laryngoscopes	9
Guide	259
Guiding Probes	105,106
Guthrie Fine Wound Retractors	117
Guyon Catheter Guide	206
Kidney Clamps	200
Urethral Bougies	206-207
Gynaecological Instruments	245
Scissors	43-44

H

Haase Tamper	351
Reposition Forceps	357
Haberer Intestinal Spatulas	150
Haemostatic ATRAUMATA Forceps	267,268
Haemostatic Forceps	70,79-86,92
Haemorrhoidal Forceps	192-193
Hajek Irrigation Cannula	197
Mallets	349
Hajek-Kofler Punches	311
Halogen Replacement Lamp	10

ALPHABETICAL INDEX

Halle Bone Curettes	345
Raspatories	332
Vascular Spatulas	258
Halsey Needle Holder	98,413
Halsted Delicate Forceps	80,81
Halsted-Mosquito Delicate Forceps	79,81
Handles	7,20,21,137,215, 219,240,259,261, 323,399
Harken Vena Cava Clamps	293
Hartmann Intestinal Clamps	174
Nasal Specula	187
Harvey Wire Cutting Scissors	48,388
Harrington Retractors	138
Harrington-Pemberton Retractors	308
Head Bands	3
Lights	4
Mirrors	3
Heaney Hysterectomy Forceps	92,93
Heaney (Hegar) Needle Holders	99
Heath Clip Removing Forceps	111
Mallet	350
Hebra Comedone Extractors	18
Hegar Needle Holders	99,410
Uterine Dilators	221-222
Hegar-Olsen Needle Holders	100
Hegar-Vascular Needle Holders	410
Hegenarth Clip Applying Forceps	111
Heiss Delicate Haemostatic Forceps	81
Ligature Forceps	89
Heister Mouth Gag	6
Hemingway Bone Curettes	343
Hennig Plaster Spreader	397
Herberhold Pocket-Accu	4
Herff Membrane Puncturing Forceps	247
Herget Biopsy Forceps	190
Herrick Kidney Pedicle Clamps	201
Hertzler Retractors	164
Rib Spreaders	300
Herz Tendon Seizing Forceps	72
Hess Forceps	62
Hey Groves Bone Holding Forceps	362
Heymann-Knight Nasal Scissors	41
Heywood-Smith Gall Bladder Forceps	196
Haemorrhoidal Forceps	192
Ovum Forceps	231
Sponge Holding Forceps	71
Tongue Forceps	6
Hoepfner Vessel Clamps	292
Hohmann-Aldinger Bone Levers	329
Holzbach Abdominal Retractor	162
Hopkins Plaster Knife	393
Hose Connection	244
Hosel Retractors	131
Hosemann Choledochus Forceps	195
Hospital Wares	414-424
House Irrigation Cannulae	333
Howarth Raspatories	240
Huber Handle	54
Hunt Tumor & Vessel Forceps	66
Hunter Splinter Forceps	104
Hurd Ligature Needles	92-94
Hysterectomy Forceps	

I

Incision Surgical Scissors	32
Inge Lamina Spreaders	161
Instrument Boxes	416
Instruments for Micro Tubal Operation	236
Interosseous Knife	16,319

Intestinal Clamps	173-180
Forceps	65,168-171
Spatulas	149-150
Intestinal And Pylorus Clamps	183
Iowa Membrane Puncturing Forceps	247
Irrigation Cannulae	257,404
Israel Retractors	127
Ives-Fansler Anusscopes	189

J

Jackson Tendon Seizing Forceps	72
Tracheal Tubes	255
Vaginal Speculums	214
Jackson Burrows Retractors	157
Jacobs Tenaculum Forceps	230
Jacobson Bone Curettes	342
Needle Holder	96
Jaeger Fine Wound Retractors	117
Jager Tendon Seizing Forceps	72
Jameson Dissecting Scissors	34
Needle Holder	99
Jansen Bone Curettes	342,343
Bone Rongeurs	366,367
Forceps	61
Head Light with Plastic Band	4
Raspatories	336
Retractors	151
Jars	406
Jenkner Instrument set for Tunnelling and Pulling-through Vascular Grafts	261
Jeweler Forceps	52
Johns-Hopkins Bulldog Clamps	77
Joll (Friedman) Retractors	157,220
Jones Towel Clamps	75
Jonesco Ligature Needles	104
Jordan Instruments	385
Joseph Bone File	339
Delicate Scissors	29
Fine Wound Retractors	117
Nasal Knives	18
Raspatories	331
Judd-Allis Tissue Grasping Forceps	168
Judd-Masson Bladder Retractors	204

K

Kader Intestinal Spatula	149
Kalt Needle Holders	96,412
Kazanjian Bone Cutting Forceps	373
Kelly Delicate Forceps	79
Delicate Scissors	29
Obstetrical Forceps	254
Ovum Forceps	231
Proctoscopes	189
Retractors	133,145
Sphincteroscopes	189
Sponge Holding Forceps	71
Kern-Lane Bone Holding Forceps	361
Kerpel Bone Curettes	343
Kerrison Punches	311
Kerrison-Jacoby Punches	312
Kersting Anastomosis Clamps	186
Kidney Clamps	200-201
Dishes	415
Elevating Forceps	202
Stone Forceps	203
Killian Bone Shears	42
Probes	109
Raspatories	333
Rectal Specula	187

ALPHABETICAL INDEX

- Luer-Koerte** Gall Stone Scoops 198
Luer-Stille Bone Rongeurs 371,372
Lung Dissecting Forceps 65
 Grasping Forceps 290
 Spatulas, Retractors 138-143,308-309
Luxation Lever 330
- M**
- Mac Donald** Raspatories 333
Magill Forceps 8
Maier Sponge Forceps 68
Maltz Bone Rasps 339
Mallets 348-350
Mannerfelt Osteotomes 351,352
 Raspatories 334
 Retractors 119
Markwalder Rib Rongeurs 297
Marquardt Bone Rongeurs 368
Martin Meniscus and Cartilage Forceps 377
 Needle Holders 414
 Pelvimeters 246
 Retractors 135
 Tenaculum Forceps 228
 Uterine Probes 224
 Vaginal Speculums 218
Martini Bone Curettes 342
Masing Retractors 122
Masson Needle Holders 99,411
Masson-Luethy Needle Holders 99
Mathieu Foreign Body Forceps 205
 Needle Holders 101,412
 Rectal Specula 188
 Retractors 124
 Vaginal Speculums 215
Mathieu-Kocher Needle Holders 412
Mathieu-Ryder Needle Holders 410
Mathieu-Stille Needle Holders 101
Mathieu-Vascular Needle Holders 412
Mayo Gall Duct Probes 197
 Safety Pin 76
 Scissors 35-37,408
 Uterine Probes 224
Mayo-Adams Retractors 154
Mayo-Harrington Scissors 36,409
Mayo-Hegar Needle Holders 99,413
Mayo-Lexer Scissors 37,406
Mayo-Noble Scissors 36
Mayo-Robson Intestinal Clamps 180
Mayo-Stille Scissors 35,36,406
Mc Indoe Forceps 56
 Tissue Forceps 64
Mc Kenty Raspatories 331
Mcintosh Laryngoscopes 10
Mead Bone Rongeurs 367
 Mallets 348
 Raspatories 333
Measuring Instruments 11
Medicine Cups 419
Membrane Puncturing Forceps 247
Meniscus Knives 378,379
 Forceps 377
Mercedes Retractor 306
Metacarpal Saw 322
Metzenbaum Dissecting Scissors 26,38,407,408
Metzenbaum-Fino Dissecting Scissors 407,408
Meyer Reposition Forceps 357
Meyerding Retractors 120,134
- Michel** Clip Applying and Removing Forceps 111
 Rhinoscopic Mirrors 7
Micro Dissecting Scissors 23-25
 Dissecting Scissors Bayonet 25
 Forceps 52,53
 Jeweller Types Forceps 52
 Ligature Forceps Bayonet 53-54,87
 Needle Holders 96-97,420
 Suture Tying Forceps 52
Micro-Adson Forceps 55,62,87
Micro-Halsted Delicate Forceps 79
Microscopic Forceps 55
Middeldorpf Retractors 130
Mikulicz Forceps 86
 Intestinal Spatula 149
 Peritoneum Forceps 91
 Retractors 144,145
Milium Knives 18
Miller Laryngoscopes 9
 Rasps 340
Millin Bladder Neck Spreader 205
 Bladder Retractors 204
 Center Blade for Retractors 204
 Ligature Holding Forceps 101
 Lobe Grasping Forceps 205
Mills Gall Duct Scissors 194
Mirror Handles 7
Mirrors for Head light 4
Mixer Dissecting and Ligature Forceps 89,90,292
 Gall Duct Forceps 195
Mixer-O'Shaughnessy Forceps 89
Modell Piccolo Cotton Applicators 109
Mod. USA Plaster Spreader 397
Modell Tubingen Retractors 135
Mollison Self-Retaining Retractors 154
Molt Raspatories 333
Moeltgen Goniometer 11
Moncorps Milium Knives 18
Mosquito Atraumata Forceps 267
Morris Anastomosis Clamps 186
 Ascending Aorta Cross Clamps 276
 Retractors 133
Morse Sternotomy Spreaders 304
Mouth Gags 6
Moynihan Forceps 86
 Gall Stone Probes 197
 Intestinal Clamps 179
Muehling Raspatories 335
Mueller Retractors 151
Multi-Purpose Clamps 283,286-287,289
Muller Fine Wound Retractors 117
 Ligature Forceps 77
 Micro Forceps 53
 Micro Needle Holders 97
 Vessel Clips 77
Murphy Head band 3
Murphy-Lane Luxation Levers 330
Museux Artery Traction Forceps 73
 Tenaculum Forceps 230
Myoma Instruments 236
 Screws 236
Myomatome 17,236
Myrtle Leaf Probes 108
- N**
- Naegle** Obstetrical Forceps 249
Nagel Micro Scissors 25
Nail Extraction Forceps 392
 Scissors 49
 Splitting Forceps 32,392

ALPHABETICAL INDEX

- Nasal Scissors** 41
 Suction Tubes 402
 Specula 187
Naujoks Wire Scissors 48
Needle Holders 96-101
Needle Holders With Tungsten Carbide Inserts 410-412
Needle Sterilizing Cases 423
Neff Meniscus Knives 378
Negus Tonsil Forceps 86
Nelaton Directors 107
Nelson Lung Dissecting Forceps 65
 Lung Grasping Forceps 290
 Trocars 208
Nelson-Metzenbaum Dissecting Scissors 38
Nerve and Vessel Hooks 115-116
Neubuser Tubal Seizing Forceps 236
Neuro-Surgery Scissors 40
Nissen Dissecting and Ligature Forceps 87
 Gall Duct Forceps 194
Non-Traumatic Haemostatic Forceps 267,268
Norfolk and Norwich Retractors 155
Noto Ovum Forceps 231
 Sponge Holding Forceps 71
Novak-Schoeckaert Endometrial Biopsy Curettes 237
Noyes Micro Spring Scissors 23
Nurse's Scissors 50
Nussbaum Intestinal Clamps 179
- O**
- Obstetrical Forceps** 247,249,250-254
 Pelvimeters 246
 Scissors 45,248
Obstetric Instruments 246-254
Ochsner Aorta Clamps 281
 Gall Duct Probes 197
 Ligature Forceps 58
 Trocars 208
Oehler Dissecting Forceps 412
Oldberg Rongeurs 317
Olivecrona Bone Rongeurs 368
 Dura Scissors 40
 Trigeminal Knife 17
 Wire Saws 323
Ombredanne Mallets 350
Operating Scissors 43,44,405
Organ and Grasping Forceps 70,71,74,170,171
Osteotomes 351-356
Osteophyte Rongeurs 318
Otoscope Complete Set 8
 Battery Handle 8
Overholt Dissecting and Ligature Forceps 88
Overholt-Geissendoerfer Dissecting and Ligature Forceps 88
Overholt-Mixter Dissecting and Ligature Forceps 87
Ovum Curettes 243
Ovum Forceps 231,232
- P**
- Parker Retractors** 123
Parker-Kerr Anastomosis Clamps 184
Parry-Cooley Aorta Clamps 288
Partsch Chisels 352
 Gouges 352
 Raspatories 331
Partsch Mod.Lange Raspatories 331
Passow Tamper 351
Patent-Ductus Clamps 273,288
Patella Forceps 358
Paulsen Raspatories 332
Payr Guiding Probes 106
 Intestinal and Pylorus Clamps 183
- Pean Haemostatic Forceps** 82-84,86
 Haemostatic Forceps Atraumata 268
 Kidney Clamps 86,200
Pederson Vaginal Speculums 211
Pedical Clamps 201
Peet Splinter Forceps 66
Pelkmann Uterine Dressing Forceps 225
Pelvimeters 246
Pelvis Retractors 148
Pennington Forceps 70
Percy Amputation Retractors 320
Perforator 254
Perkins Retractors 153
Peripheral-Vascular Clamps 274-275
Percussion Hammers 1
Periosteum Knife 319
Peritoneum Forceps 91
Pertuiset Carotid Clamps 294
Phalangeal Knife 319
Phaneuf Hysterectomy Forceps 92
Picclo Cotton Applicators 108
Pierce Antrum Trocars 208
Pinard Stethoscopes 2
Placenta and Ovum Curettes 243,252-254
Plaster Breakers 397
 Instruments 393-397
 Knives 393
 Saw 393
 Scissors 51,394
 Shears 395,396
 Spreaders 397
Plester Retractors 153
 Suction Tube 402
Pliers For Bending and Cutting Wires 387
Pocket Instrument Set 112-113
Polyaethylen Splint Material 236
Polypus and Ovum Forceps 231,232
Pool Suction Tube 400
Post Mortem Knives 13
Potts-De Martel Gall Bladder Scissors 196
Potts-Smith Forceps 409
 Scissors 39,40
Pozzi Tenaculum Forceps 227
Pratt Organ Grasping Forceps 74
 Rectal Specula 188
Pressure Clamps 94,184,193,276
Price Thomas Bronchus Forceps 295
Probes 106-109,385
Proctoscopes 189
Protection Caps (Steinmann Pins) 382
Providence-Hospital Delicate Forceps 79
Punches 310-312
Putti Bone File 341
- Q**
- Quervain Bone Levers** 324
Quinby Delicate Scissors 29
- R**
- Rabiner Percussion Hammer** 1
Ragnell Scissors Flat Point 26,410
Ramley Sponge Holding Forceps 70
Randall Endometrial Biopsy Curettes 237
 Kidney Stone Forceps 203
Rankin Delicate Forceps 80
Raspatories 331-338
Rasps 339-341
Razors 22
 Blade Holders 19
Recamier Ovum Curettes 243
 Uterine Curettes 241

ALPHABETICAL INDEX

Troutman-Chris Blade Holder	19
Tubal Seizing Forceps	236
Tubbs Aortic Dilators	260
Tuffier Intestinal Spatula	150
Rib Spreaders	300
Tissue Grasping Forceps	168
Tungsten Carbide Instruments	407-413
Tunnelling Instruments	261
Turnable Biopsy Forceps	190
Tuttle Lung Dissecting Forceps	65
Lung Grasping Forceps	290

V

Ueckermann-Denker Cryothyrotomy Trocar	255
Uffenorde Bone Curettes	343
Ultra-Light Forceps	59,172,262
Umbilical Cord Scissors	45,248
Universal Bandage Scissors	50
Handle	240
Trays	415
Trocars	208
Wire Cutting Scissors	48,388,413
Unna Extractor	18
Ureter Forceps	205
Urethral Bougies Urinary Instruments	206
Uterine Curettes	241,242
Depressor	224
Dilators	221,222
Dressing Forceps	225,226
Elevating Forceps	233-235
Flushing Tube	245
Probes	224
Scissors	43,44,409
Scoops	241
Secretion Scoop	237
Tenaculum Forceps	227-230
US-Army Retractors	124

V

Vacuum Curettes	244,398
Vaginal Clamps	93-94
Retractors	157,217,218,220
Speculas	209-219
Vaginal and Wound Retractors	218
Van Buren Bone Holding Forceps	359
Vannas Micro Spring Scissors	23,24
Vario Retractors	136,137,215
Vascular Dilators	257
Spatulas	258
Vein Retractors	122
Vena Cava Clamps	270,271,293
Venae Sectio Set	113-114
Verbrugge Bone Holding Forceps	363
Verbrugge-Muller Bone Levers	328
Vernier Caliper	11
Vessel Clamps	292
Hooks	115,116
Irrigation Cannulae	257
Scissors	39
Vienna Nasal Specula	187
Vidal Lupus Scraper	18
Virchow Knife	13
Vise Grip Pliers	387
Micro Forceps	52
Volkmann Bone Curettes	342,344
Bone Retractors	125,126

W

Wachenfeldt Clip Applying Forceps	111
Wagener Vessel Hooks	115
Wagner Bone Levers	327
Mallets	349
Meniscus Knives	378
Raspatories With Hartpress Handle	338
Rongeurs	318

Walb Knife	13
Walter Gouges	353
Wangensteen Forceps	409
Intestinal Grasping Forceps	170
Needle Holders	99
Wartenberg Pinwheel	1
Waugh Tissue Forceps	64
Weber Aorta-Anastomosis Clamps	282
Webster Needle Holders	98
Wecker Eye Scissors	23
Weil-Blakesley Rongeurs	313
Weissbarth Vaginal Speculum	217
Weitlaner Self-Retaining Retractors	152-153
Weller Meniscus and Cartilage Forceps	377
Wertheim Anastomosis Clamps	275
Clamps and Forceps	92-95,201
Gynaecological Scissors	43,409
Hysterectomy Forceps	92
Parametrium Clamps	93
Wertheim-Cullen Clamps and Forceps	95
Wieder Tongue Depressor	5
Wiener Modell Suture Hooks	106
Wikstroem Dissecting and Ligature Forceps	291
Wilde Forceps	61
Willett Scalp Flap Forceps	251
Williams Intestinal Grasping Forceps	170
Lung Grasping Forceps	290
Williger Bone Curettes	342,344
Elevators	324
Raspatories	331
Retractors	120
Winter Ovum Forceps	252
Wire Catcher	385
Cutters	388
Cutting Pliers	387,389-391
Cutting Scissors	48,388,408
Extentions	380,381
Guides	384
Holding Forceps	386,387
Saws	323
Tightener	380,383,385
Tightening Pliers	386
Traction Bow	380,381
Twister	385
Winkelmann Circumcision Clamps	207
Wolff Plaster Breakers	397
Wound Retractors	117-118,122
Wound and Tracheal Hooks	256
Wrenches	380
Wrigley Obstetrics Forceps	250
Wullstein Self-Retaining Retractors	153
Suction Tube	403

Y

Yankauer Suction Cannulae	309,401
Yasargil Ligature Forceps	53,87
Micro Forceps	53
Micro Needle Holders	96,97,420
Micro Scissors Bayonet	25
Rongeurs	317
Suction Cannulae	309,403,404
Tumor & Vessel Forceps	54
Yasargil-Samii Tissue Grasping Forceps	54
Yeoman Biopsy Forceps	190
Young Tongue Forceps	6
Young-Hryntschak Needle Holder	101
Young-Millin Boomerang Needle Holder	101

Z

Zenker Forceps	89
Retractor	139
Ziegler Head Band	3
Head Mirror	3
Miliun Knives	18
Zielke Gouges	355

PAK K.T.S. INTERNATIONAL

St.no. 3 Faizabad Pacca Garrah Sialkot Pakistan

Tel/fax: 92-52-4265218 E-mail: Info@pakkts.com Web: www.pakkts.com



Tajmir : 0092 300 9619551