



DENTAL

INSTRUMENTS GUIDE



PAK K.T.S.
international

Manufacturer & exporter Surgical And Dental Instruments

SERVING THE HEALTH CARE INDUSTRY

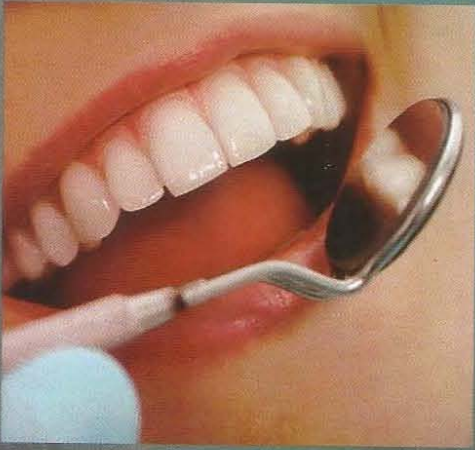

*Keep Smiling
Be Healthy*

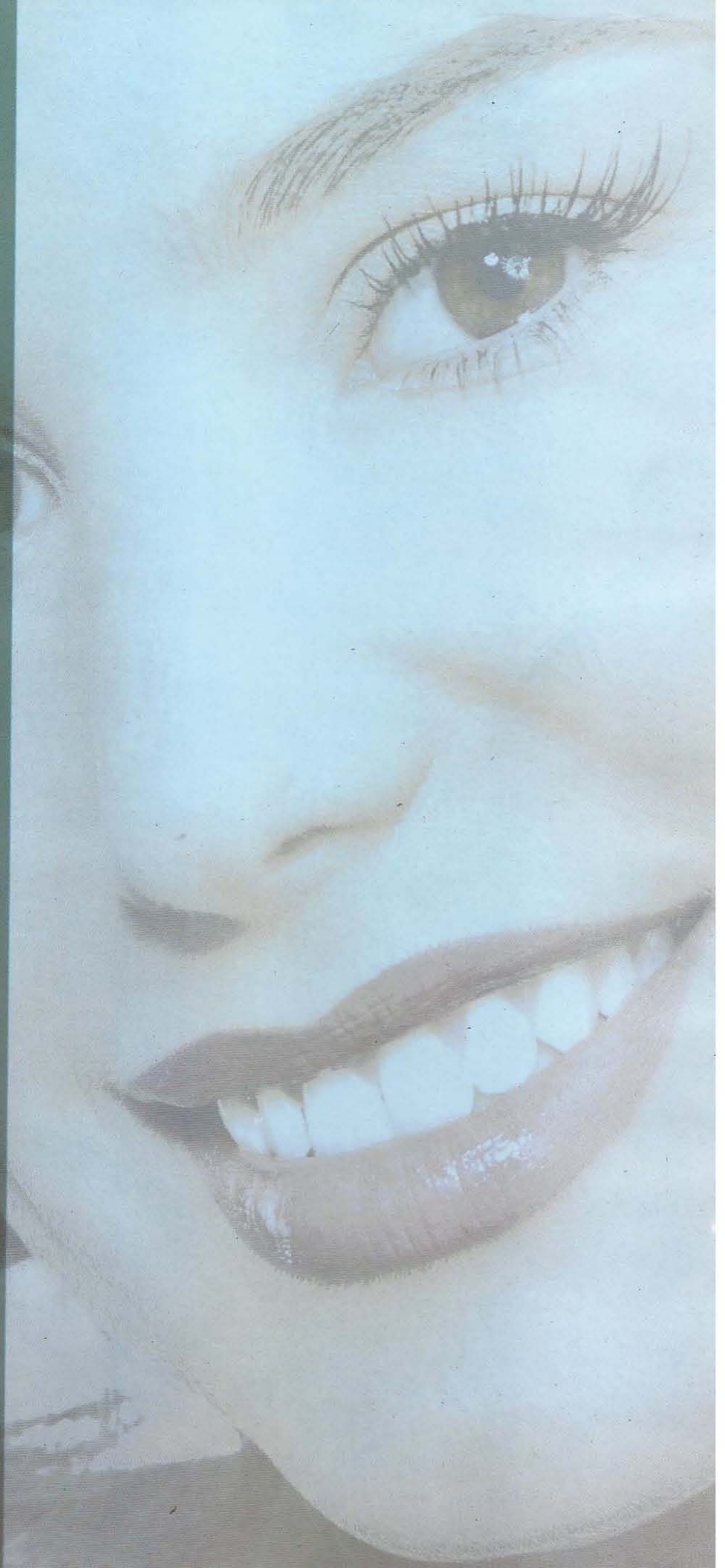



QUALITY DENTAL INSTRUMENTS



CONTENTS

SURGICAL & IMPLANTS SURGERY 01 TO 25

EXTRACTIVE 26 TO 86

DIAGNOSTIC 87 TO 97

RESTORATIVE 98 TO 129

PERIODONTIA 130 TO 147

INSTRUMENT TRAYS (STAINLESS STEEL) 148 TO 160
HOLLOW WARES, IMPRESSION TRAYS

LABAROTARY INSTRUMENTS 151 TO 170

ORTHODONTICS 171 TO 180

TC INSTRUMENTS 181 TO 188

HANDLES REFERENCE GUIDE 189 TO 191

SURGICAL IMPLANTS SURGERY



Scalpel Handles
Bistouris á gencivas
Bisturis para encia

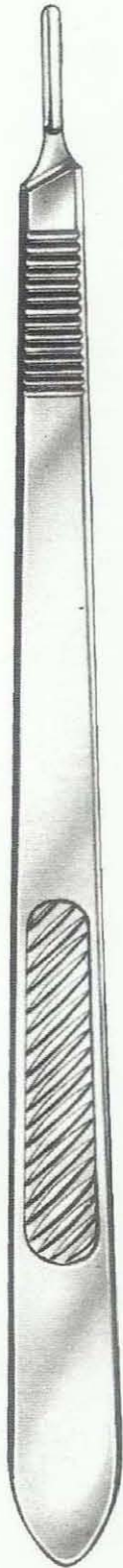

786-101
Fig:3L



786-102
Fig:7



786-103
Fig:5



786-104
Fig:5A



786-105
Fig:3



786-106
Fig:3G



786-107
Fig:4

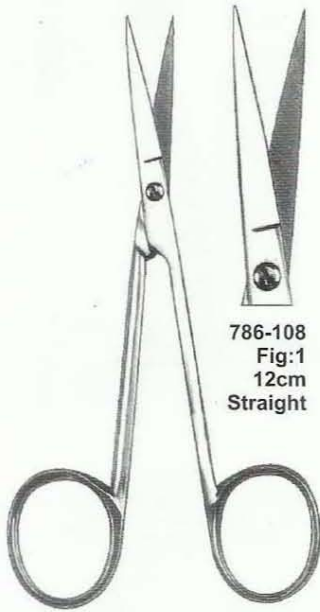

786-108
 Fig:1
 12cm
 Straight

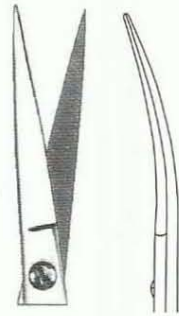

786-109
 Fig:2
 12cm
 Curved

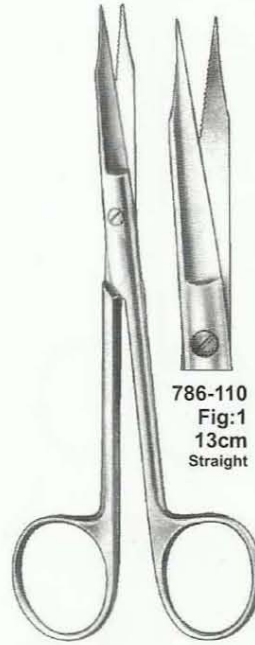

786-110
 Fig:1
 13cm
 Straight

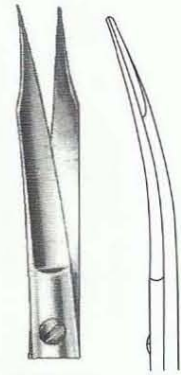

786-111
 Fig:2
 13cm
 Curved

Goldman-Fox
 Saw edge

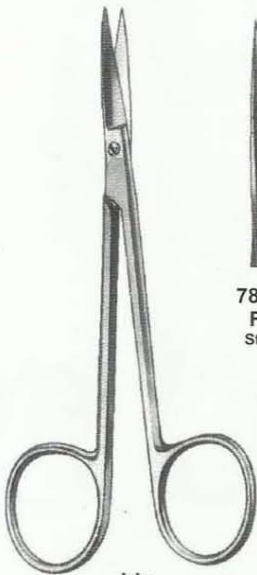

786-112
 Fig:1
 Straight

Iris
 11.5cm

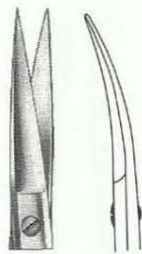

786-113
 Fig:2
 Curved



786-114
 Fig:3
 Curved



786-115
 Fig:1
 Angular
 saw edge

786-116
 Fig:2
 Angular

11,5cm
 Angular, Saw edge

Gum Scissors
 Ciseaux á gengivas
 Tijaras para encias

Curved, saw edge

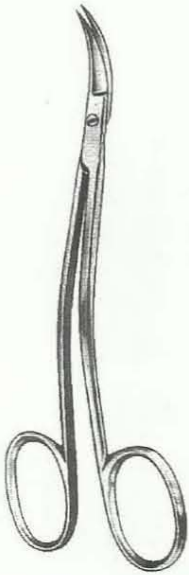

786-117
 Fig:1
 La Grange
 10,5 cm

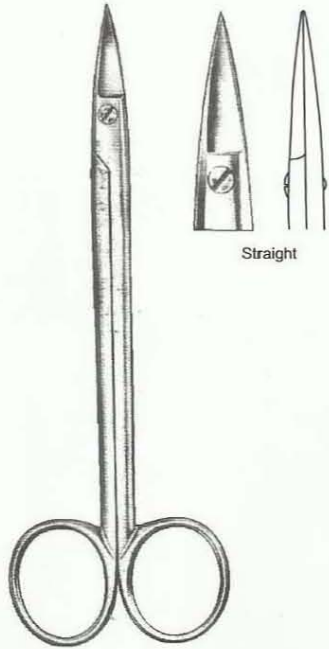

786-118
 Fig:1
 Quinby
 12,5 cm

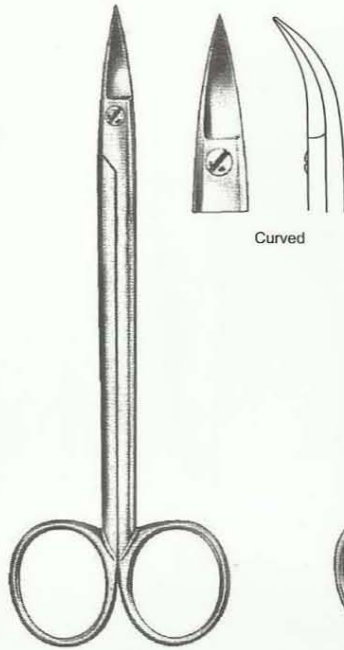

786-119
 Fig:2
 Quinby
 12,5 cm

Curved, saw edge

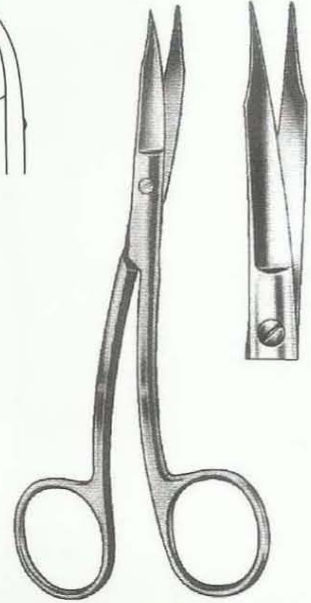

786-120
 Fig:3
 Goldman-Fox (Special)
 13 cm

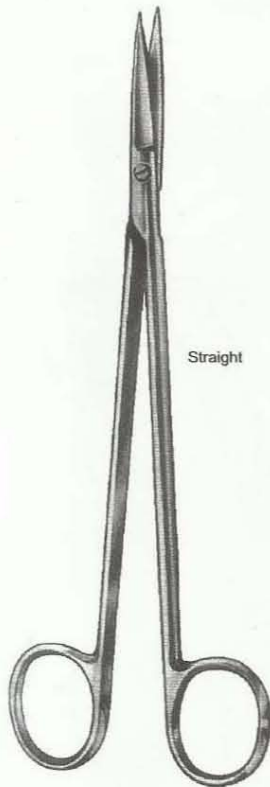

Straight

786-121
 Fig:1
 Kelly
 16 cm

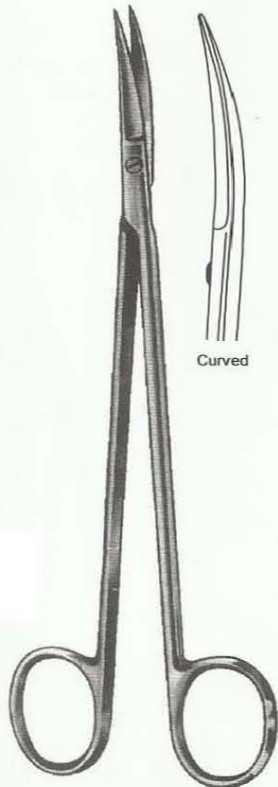

Curved

786-122
 Fig:2
 Kelly
 16 cm

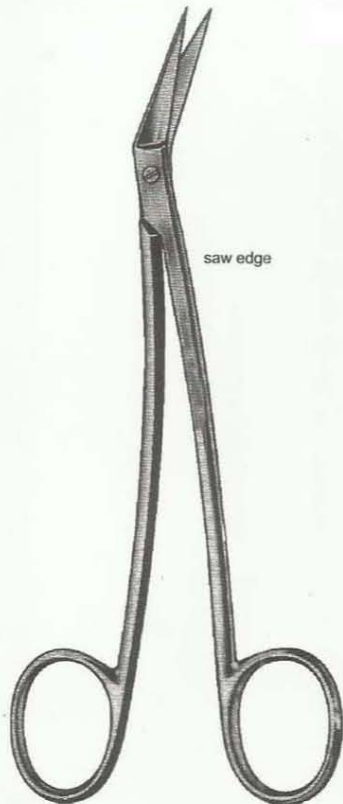

saw edge

786-123
 Fig:1
 Locklin
 16,5 cm

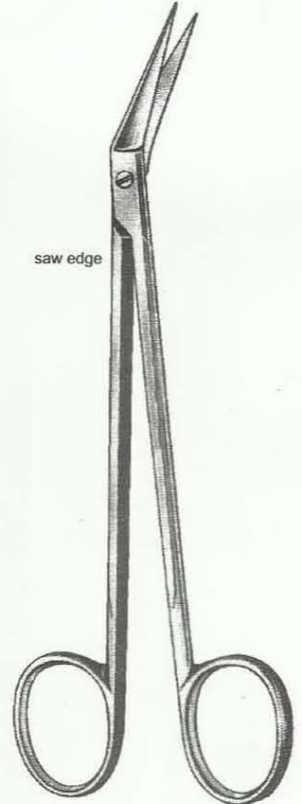

saw edge

786-124
 Fig:2
 Locklin
 16,5 cm

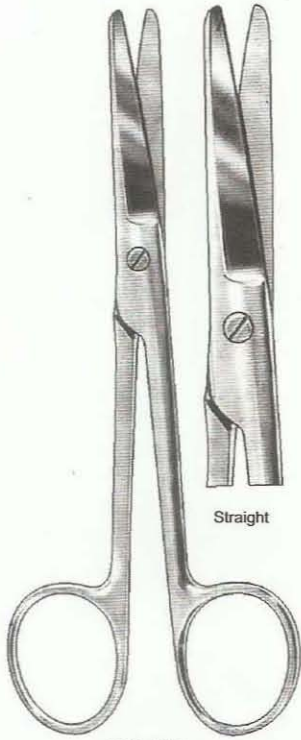

786-125
 Fig:1
 Mayo
 14.5 cm

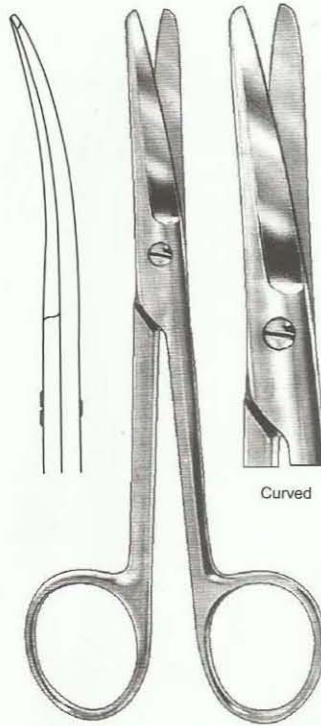

786-126
 Fig:2
 Mayo
 14.5 cm

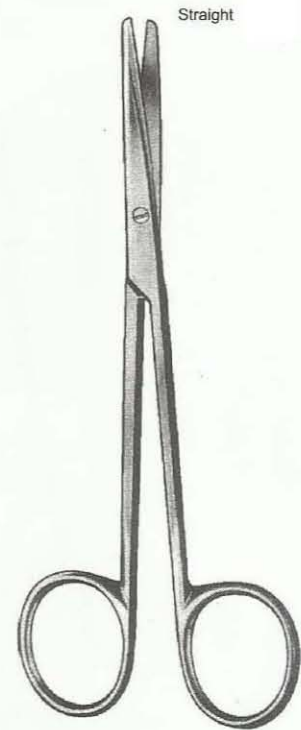

786-127
 Fig:1
 Metzenbaum
 14.5 cm

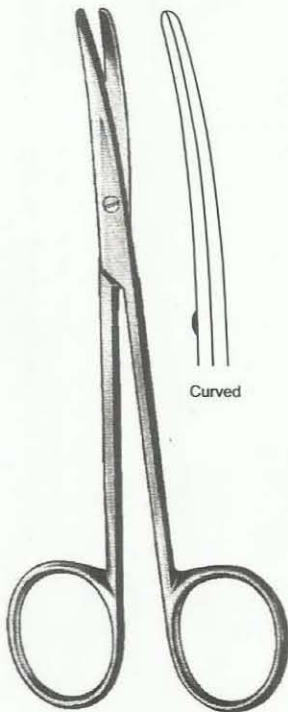

786-128
 Fig:2
 Metzenbaum
 14.5 cm

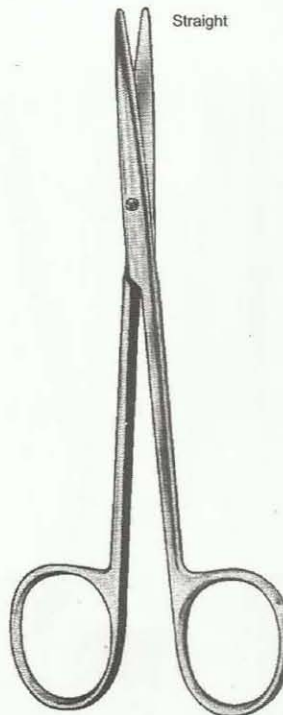

786-129
 Fig:1
 Metzenbaum-Delicate
 14,5 cm

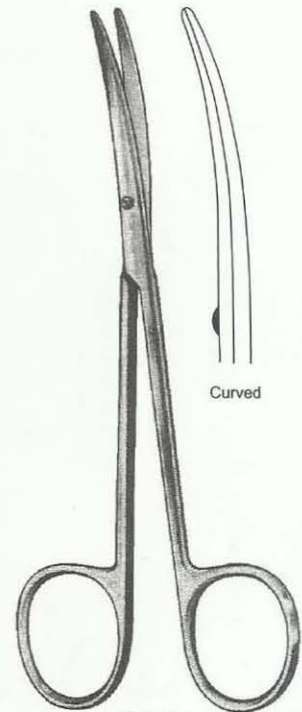

786-130
 Fig:2
 Metzenbaum-Delicate
 14.5 cm

Surgical Scissors
 Ciseaux à Chirurgie
 Tijaras para cirugía

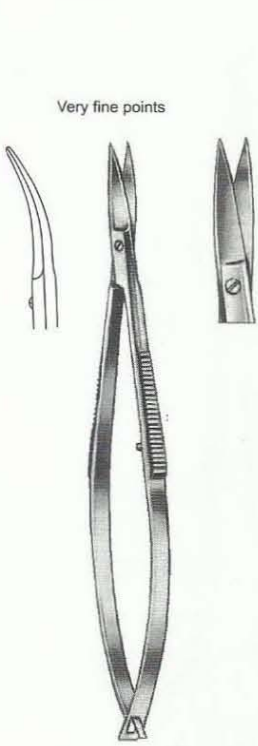

786-131
 Fig:1
 Noyes (Castroviejo)
 12 cm

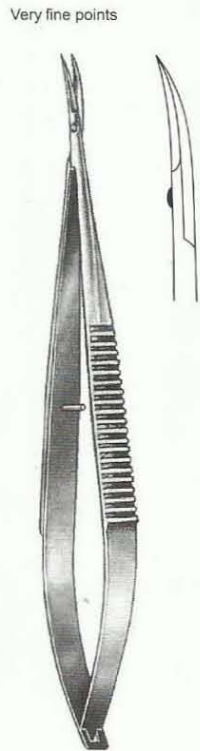

786-132
 Fig:1
 14,5 cm

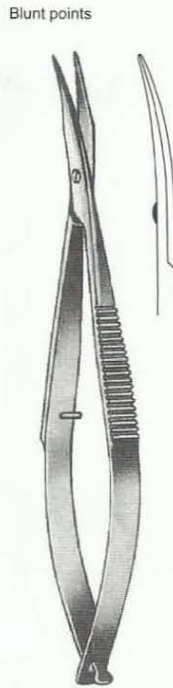

786-133
 Fig:1
 Westcott
 11 cm

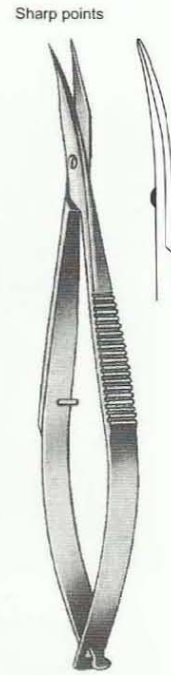

786-134
 Fig:2
 Westcott
 11 cm

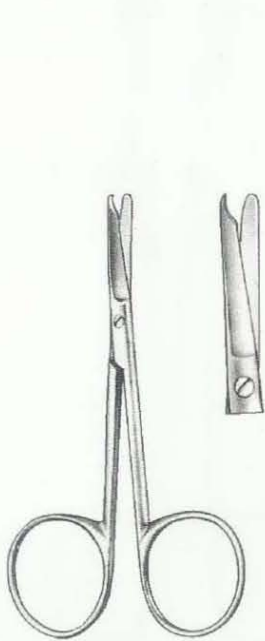
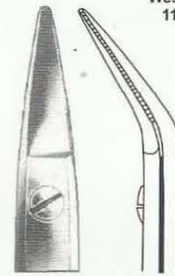

786-135
 Fig:1
 Spencer
 9 cm

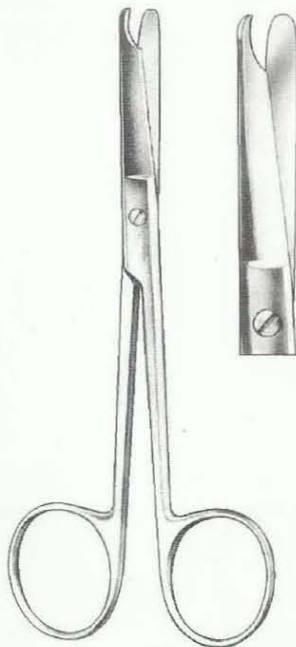

786-136
 Fig:2
 Spencer
 9 cm

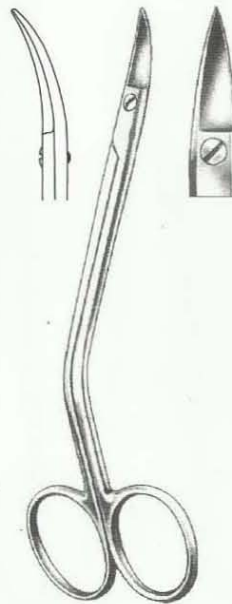

786-137
 Fig:1
 Neumann
 12,5 cm

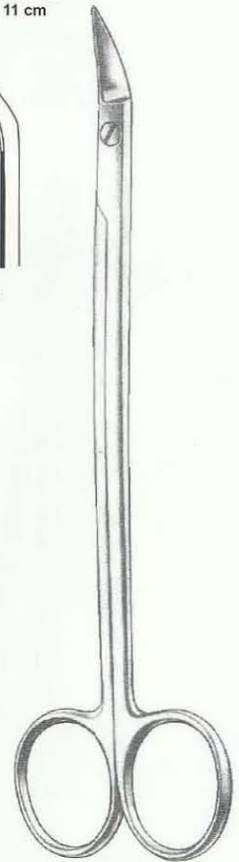

786-138
 Fig:1
 Dean
 17 cm

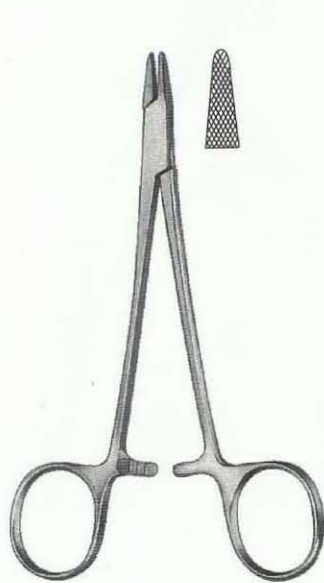

786-139
 Baumgartner
 14.5 cm



786-140
 Crile-Murray
 15 cm



786-141
 Mayo-Hegar

15 cm 18 cm 20 cm
 Medium Fine Patterns

Designed for Frontal & Palate Suture

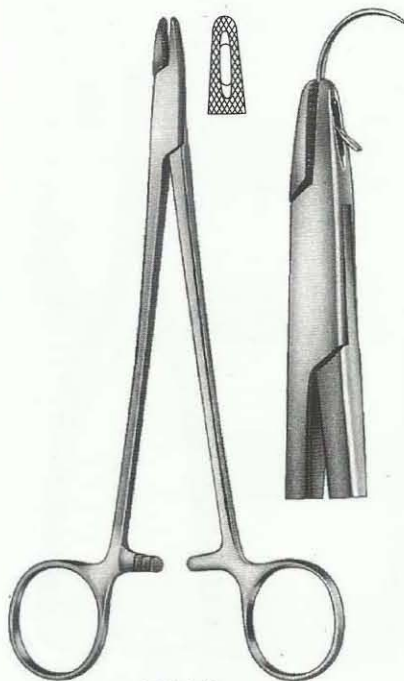

786-142
 Adson
 17,5 cm

Needle holders with Scissors

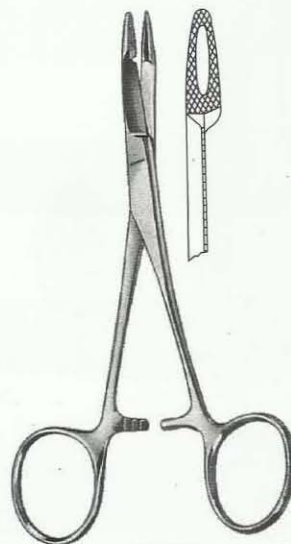

786-143
 Heger-Olson
 14 cm

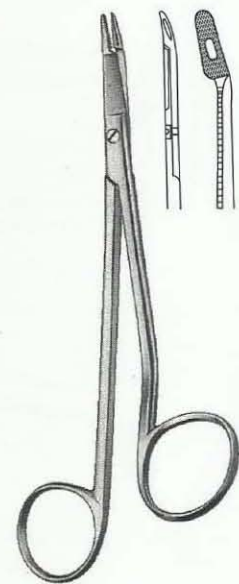

786-144
 Gillies
 15 cm

Needle Holders
 Porte-aiguilles
 Porta-agujas

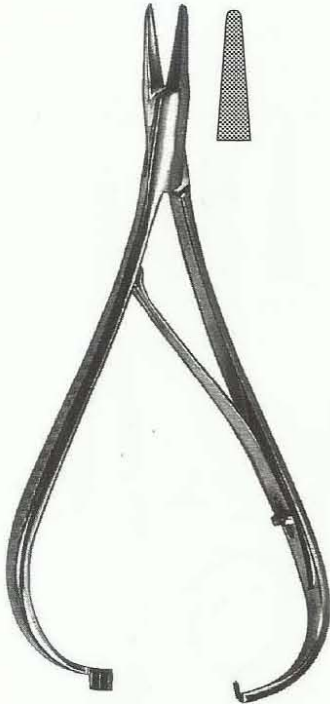

786-145
 Mathieu
 14 cm

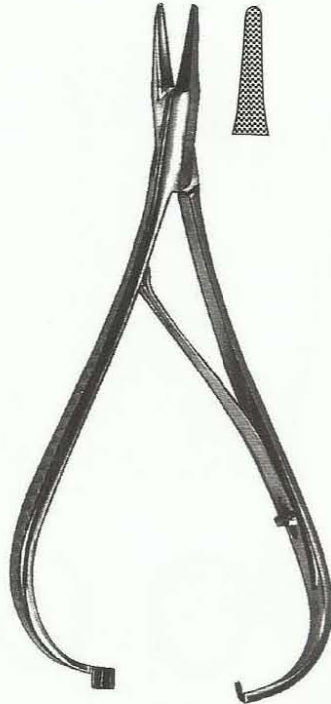

786-146
 Mathieu
 14 cm

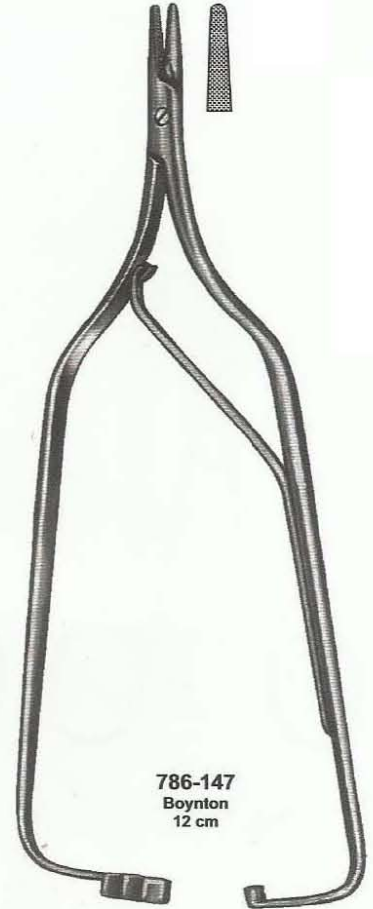

786-147
 Boynton
 12 cm

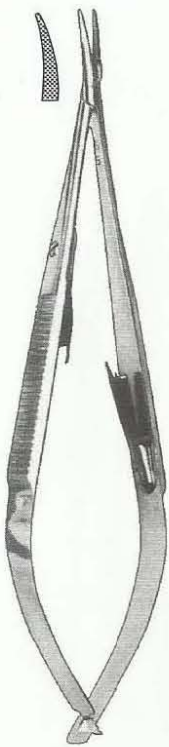

786-148
 Castroviejo
 14 cm,

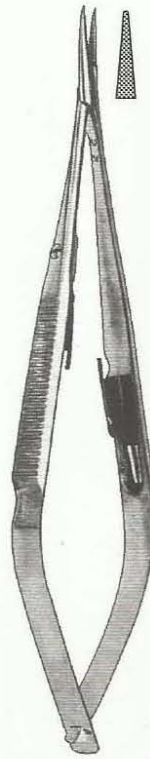

786-149
 Castroviejo
 14 cm



786-150
 Castroviejo
 13 cm

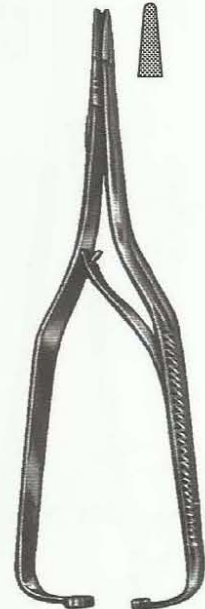

786-151
 Arruga
 16 cm

786-152
Fig.1
Adson
12 cm



786-153
Fig.1
Adson 1x2
12 cm

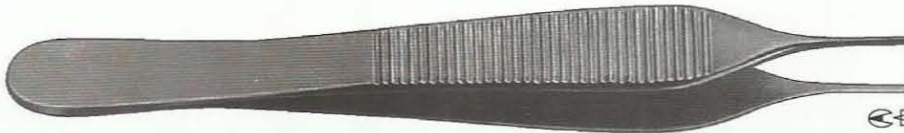

786-154
Fig.1
Semken-Taylor
12,5 cm



786-155
Fig.2
Semken-Taylor
12,5 cm



786-156
Fig.1
Semken-Taylor 1x2
12,5 cm

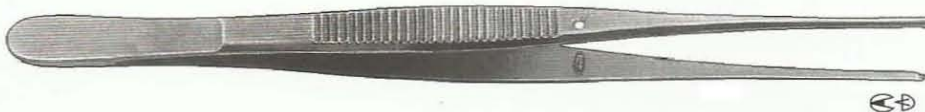

786-157
Fig.2
Semken-Taylor 1x2
12,5 cm



786-158
12 cm



786-159
11,5 cm



786-160
11,5 cm



786-161
11,5 cm



Haemostatic Forceps
 Pincès hèmostatiques
 Pinzas hemostàticas

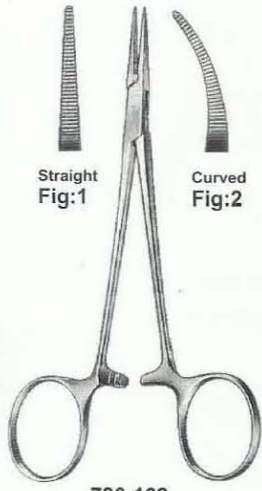

Straight
Fig:1

Curved
Fig:2

786-162
Micro-Halsted

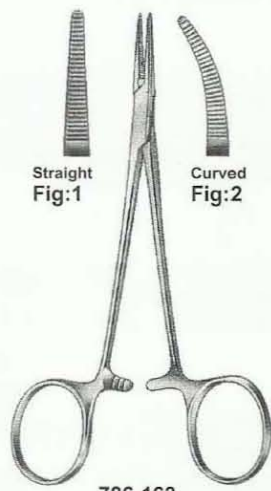

Straight
Fig:1

Curved
Fig:2

786-163
Halsted-Mosquito

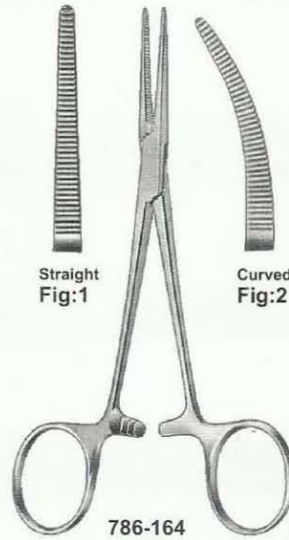

Straight
Fig:1

Curved
Fig:2

786-164
Crile
14 cm

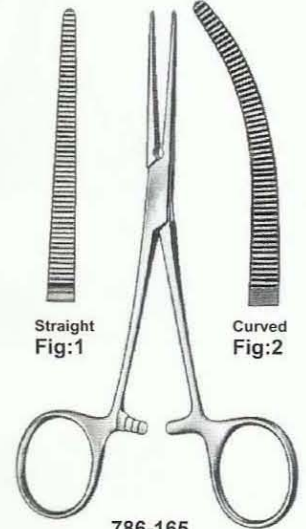

Straight
Fig:1

Curved
Fig:2

786-165
Pean

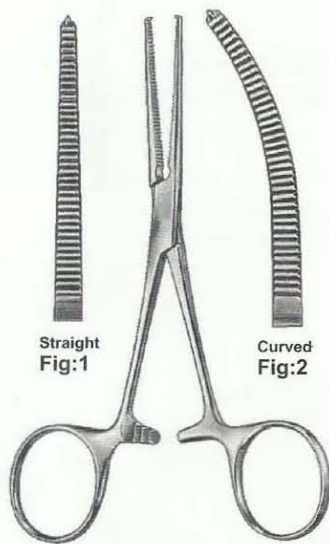

Straight
Fig:1

Curved
Fig:2

786-166
Kocher

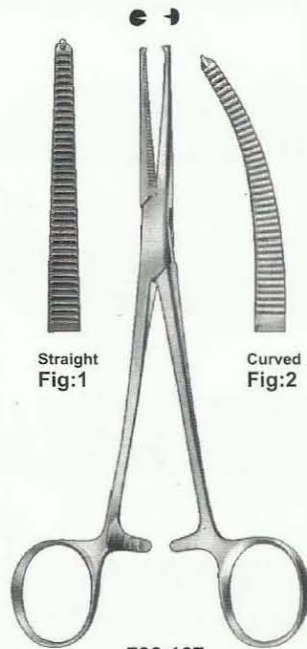

Straight
Fig:1

Curved
Fig:2

786-167
Crile(Kocher)

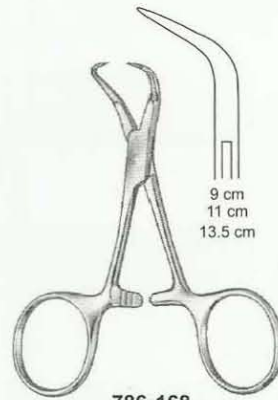

9 cm
11 cm
13.5 cm

786-168
Backhaus

Tuchklemmen
 Towel Forceps
 Pincès à compresses
 Pinzas para compresas

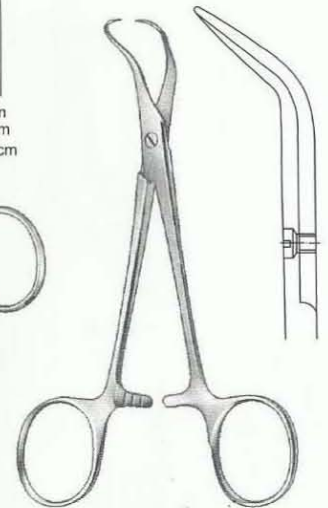

786-169
Backhaus-Kocher
13.5 cm

Sponge Forceps
Schwammzangen
Pinzas para tapones

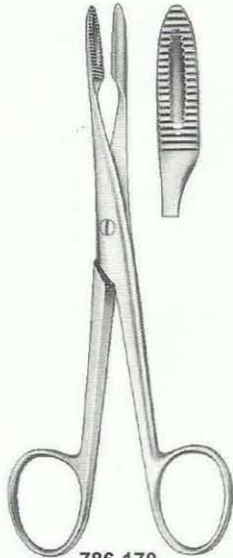

786-170
Without Ratchet
14,5 cm

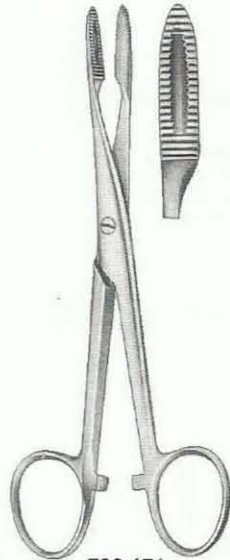

786-171
With Ratchet
14,5 cm

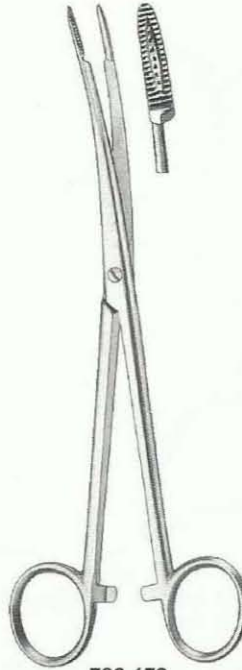

786-172
Curved
17,5 cm

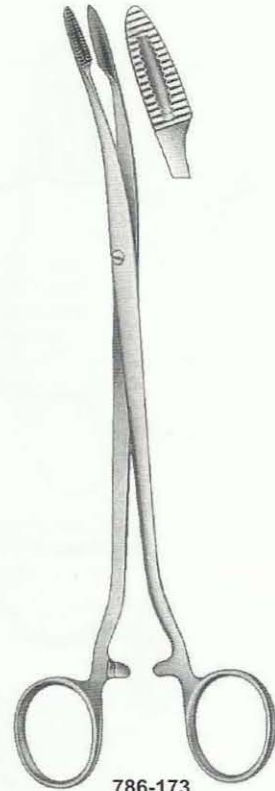

786-173
Curved
21 cm

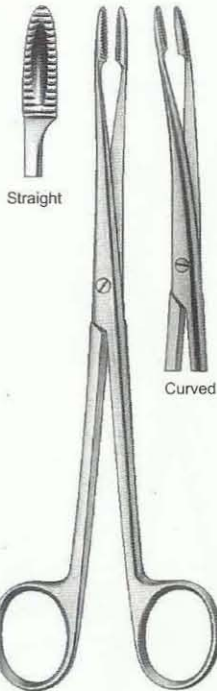

786-174
Without Ratchet
18 cm

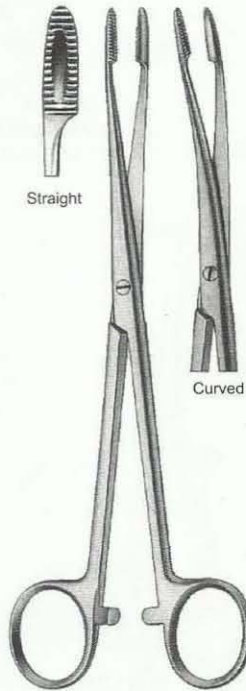

786-175
With Ratchet
18 cm

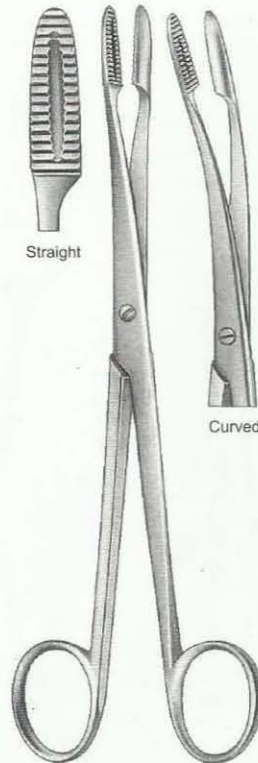

786-176
Without Ratchet
20 cm

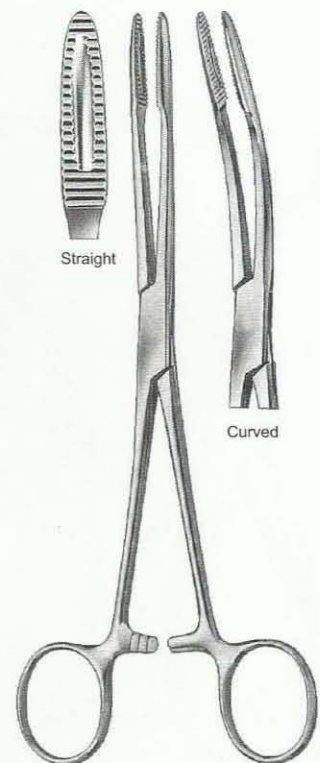

786-177
With Ratchet
20 cm

Retractors - Mouth Gags
 Ecarteurs - Ouver-bouches
 Separadores - Abre-bocas



786-178/11 cm
 786-179/13 cm
 786-180/15 cm
 whitehead

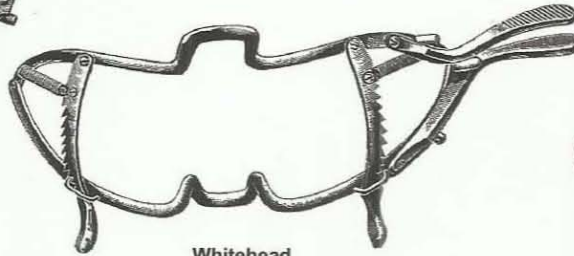

Whitehead
 786-181/11 cm
 786-182/13 cm
 786-183/15 cm

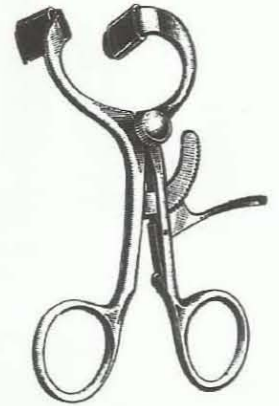

Molt
 786-189
 11 cm
 14 cm



786-184/11 cm
 786-185/13 cm
 786-186/15 cm
 Jennings

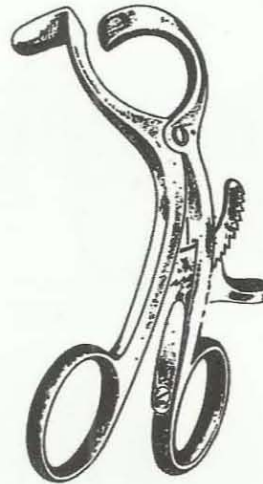

DOYEN
 786-187 CHILD
 786-188 ADULT

Mundsperrer

Mouth Gags
 Ouver-bouches
 Abre-bocas

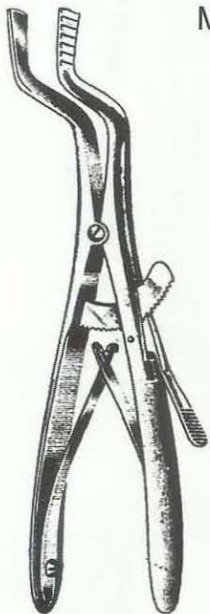

ROSER-KONIG
 786-190/16cm
 786-191/19cm



DENHART
 786-192

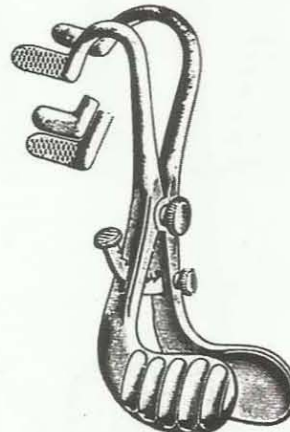

BUXTON
 786-193 A.JAWS
 786-194 P.JAWS

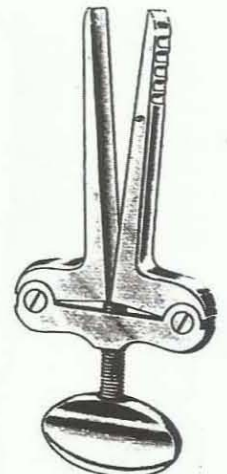

HEISTER
 786-195/13cm

Retractors - Mouth Gags
 Ecarteurs - Ouver-bouches
 Separadores - Abre-bocas

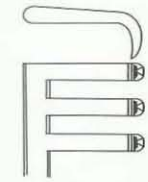

786-196/1
Sharp

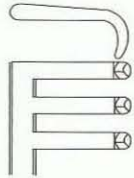

786-197/1
Blunt

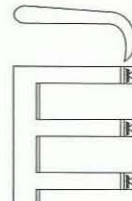

786-198/2
Sharp

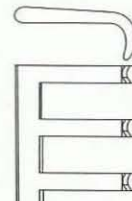

786-199/2
Blunt

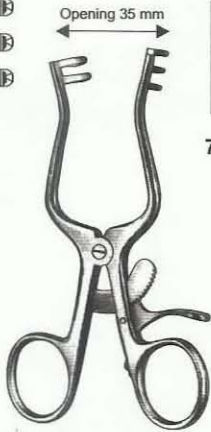

Weitlaner
10.5 cm
2:3 Teeth

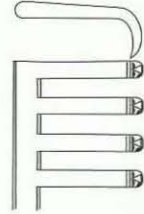

786-200/1
14 cm
16.5 cm
18 cm
20 cm
24.5 cm
Blunt

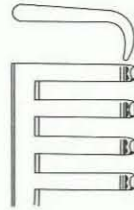

786-201/2
14 cm
16.5 cm
18 cm
20 cm
24.5 cm
Blunt

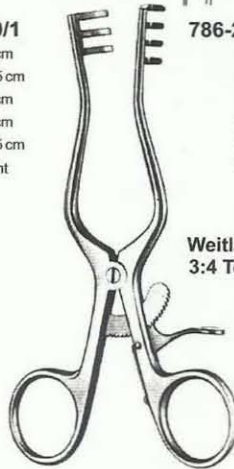

Weitlaner
3:4 Teeth

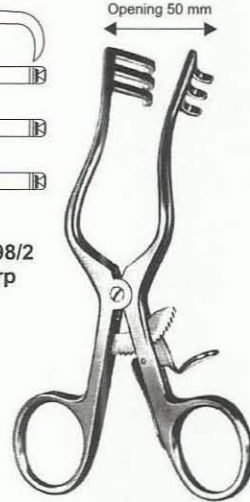

Weitlaner-Wullstein
14 cm
3:3 Teeth

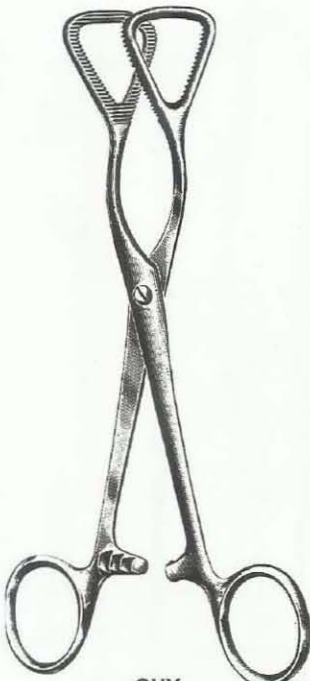

GUY
786-202/16cm

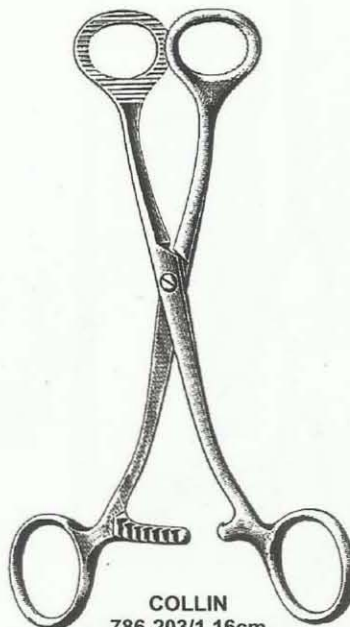

COLLIN
786-203/1 16cm
786-204/2 17cm
786-205/3 19cm

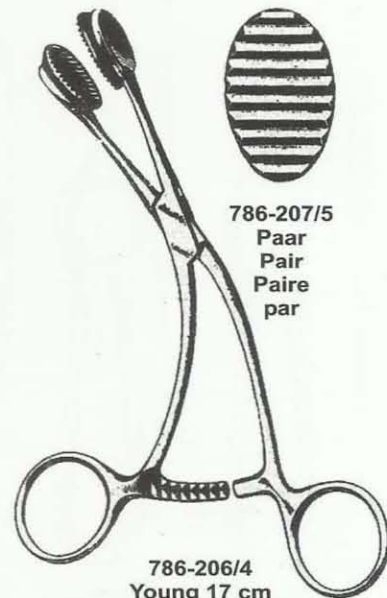

786-206/4
Young 17 cm

786-207/5
Paar
Pair
Paire
par

Retractors
Ecarteurs
Separadores

15 x 15 mm



786-208/1

20 x 22 mm



786-209/2

28 x 28 mm



786-210/3

15 x 15 mm



786-211/1

20 x 22 mm



786-212/2

28 x 28 mm



786-213/3

30 x 10 mm



786-214/1

40 x 10 mm



786-215/2

40 x 13 mm



786-216/3

50 x 10 mm

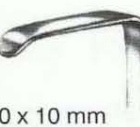

786-217/4

50 x 13 mm

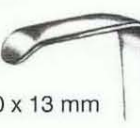

786-218/5

———— Middelдорpf ————

———— Middelдорpf ————

———— Langenbeck ————

56 x 11 mm



786-219/1

40 x 11 mm

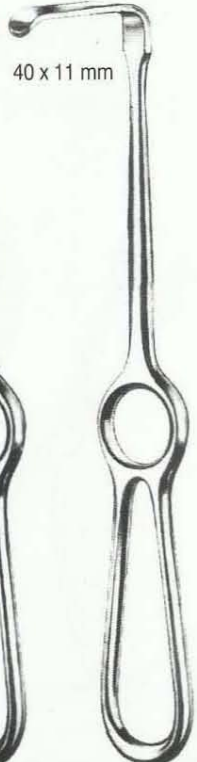

786-220/2

———— Kocher ————

23 x 20 mm



786-221
Wassmund

scharf
sharp
pointus
agudos



786-222/1

stumpf
blunt
mousses
romos



786-223/2

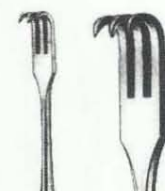

786-224/3
Senn-Mueller

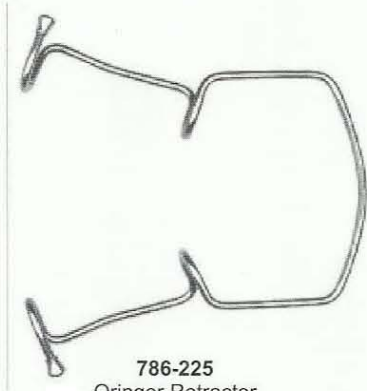

786-225
Oringer Retractor
11x8 cm



786-226/1

scharf
sharp
pointus
agudos

— Thoma —

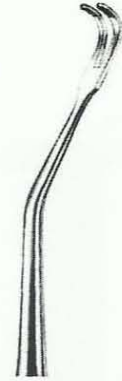

786-227/2

stumpf
blunt
mousses
romos



786-228/13 cm
Farabeuf

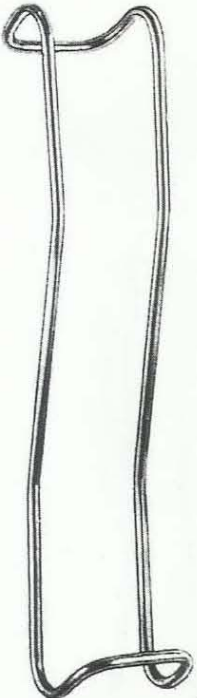

786-229/12 cm
786-230/14 cm
786-231/16 cm

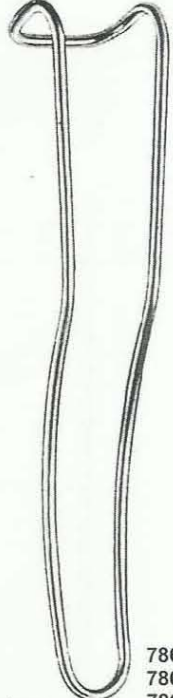

786-232/14 cm
786-233/16 cm
786-234/18 cm

Sternberg

Lippenhalter
Lip Retractors
Ecarteurs des lèvres
Separadores de los labios



786-235/1
Bruenings

Zungenspateln
Tongue Depressors
Abaisse-langues
Abaja-lenguas



786-236/2
Bruenings



786-237/1

Tamponstopfer
Gauze Packers
Porte-tampons
Tamponeadores



786-238/2

Luniatschek
Tamponstopfer
Gauze Packers
Porte-tampons
Tamponeadores

Tongue Depressors
Zungenspatel
Abaja-lengua



786-239
16 cm / 6¼"
Wooden



786-240
15 cm / 6"
Plastic



Haas
786-241
16 cm / 6¼"
Acrylic glass



Buchwald
786-242
17 cm / 6¾"
Acrylic glass



Boilable
786-243
18.5 cm / 7¼"
Blue nylon
Can be autoclaved



786-244
14.5 cm / 5¾"



786-245
14.5 cm / 5¾"

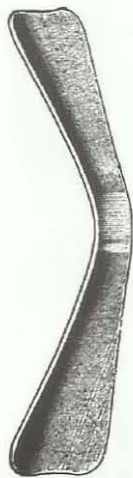

Doyen
786-246 13 cm / 5"
786-247 16 cm / 6¼"



Kroenig
786-248
15 cm / 6"



Mayo
786-249
17 cm / 6¾"



Collin
786-250
16.5 cm / 6½"



786-251
16.5 cm / 6½"

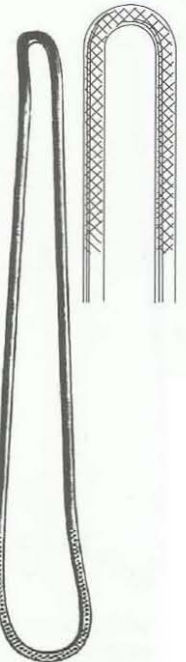

Frenzel
786-252
16.5 cm / 6½"

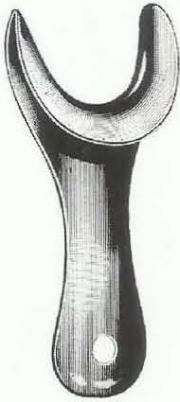

Simplex
786-253
 11 cm / 4½"

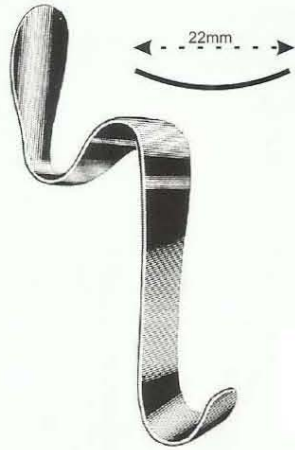

Bishop
786-254
 13 cm / 5"



Cawood-Minnesota
786-255
 15.5 cm / 6"
 Without fiber optics

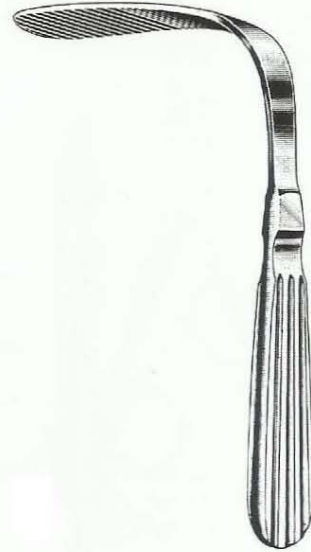

Tobold
786-256
 14.5 cm / 5½"

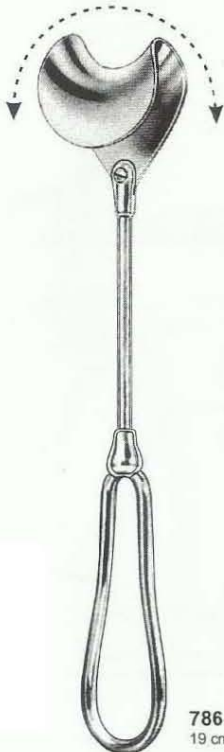

786-257
 19 cm / 7½"

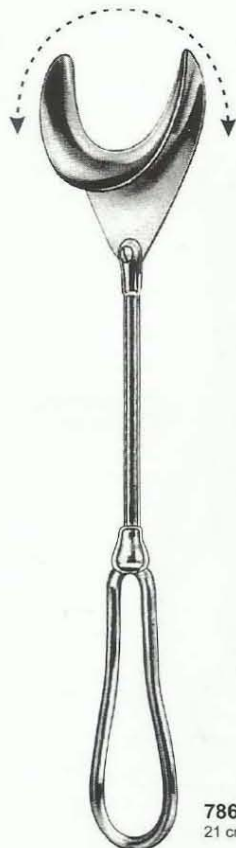

786-258
 21 cm / 8¼"

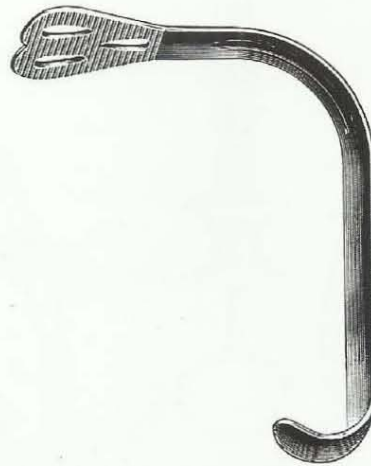

Wieder



786-259
 14 cm / 5½"



786-260
 15 cm / 6"

Dental Syringes, Cartridge Syringes
 Dental Spritzen, Ampullen Spritzen
 Jeringuillas dentales, Jeringas para catucho-ampollas



(ml 1.8)

786-261
 Aluminium-Dark
 Alluminio-Nera

786-264
 Aluminium-Green
 Alluminio-Verde

786-262
 Aluminium-Silver
 Alluminio-Argento

786-265
 Aluminium-Blue
 Alluminio-Blu

786-263
 Aluminium-Orange
 Alluminio-Arancio



786-266
 U.S. thread
786-267
 Metric thread



786-268
 U.S. thread
786-269
 Metric thread

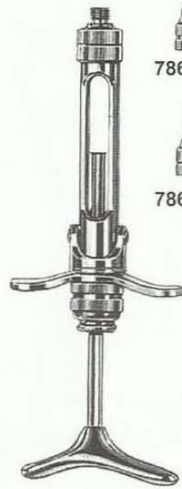

786-274

786-275

Cylinder cartridge syringe

786-270
 1.8 cc with metric thread
786-271
 2.2 cc with metric thread
786-272
 1.8 cc with U.S. thread
786-273
 2.2 cc with U.S. thread



786-276
 U.S. thread
786-277
 Metric thread



786-278
 U.S. thread
786-279
 Metric thread

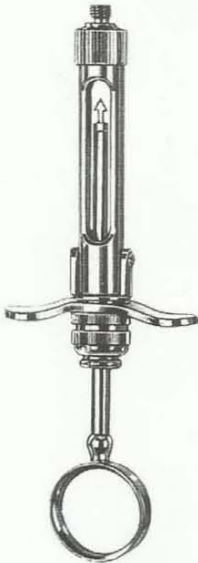

Cylinder cartridge syringe

786-280
 1.8 cc with metric thread
786-281
 2.2 cc with metric thread
786-282
 1.8 cc with U.S. thread
786-283
 2.2 cc with U.S. thread

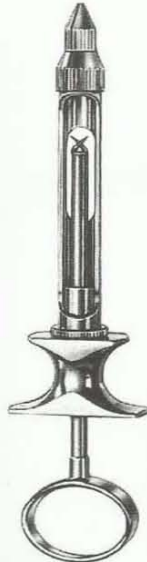

Cylinder cartridge syringe

786-284
 1.8 cc with metric thread
786-285
 2.2 cc with metric thread
786-286
 1.8 cc with U.S. thread
786-287
 2.2 cc with U.S. thread

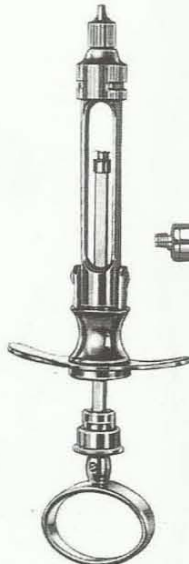

Cartridge syringe

786-288
 with metric thread
786-289
 with U.S. thread



Cartridge syringe

786-290
 Intra-Ligamental syringe
 With connection for universal needles

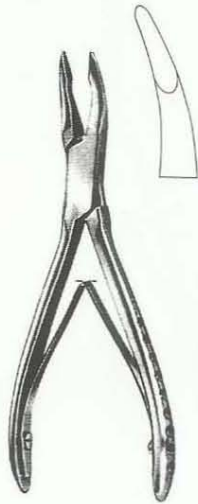

Mini-Friedman
786-291
12 cm / 5"

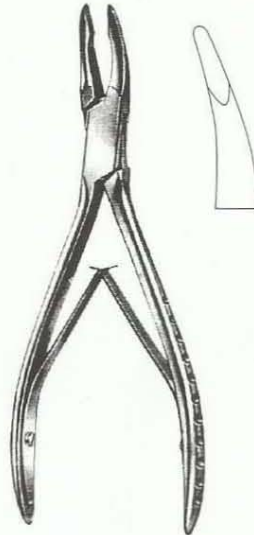

Friedman
786-292
14 cm / 5½"

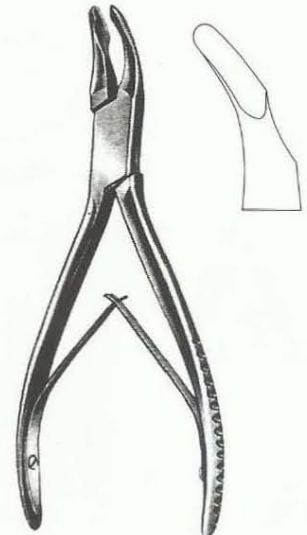

Cleveland
786-293
14 cm / 5½"



Cleveland
786-294
17 cm / 6¾"

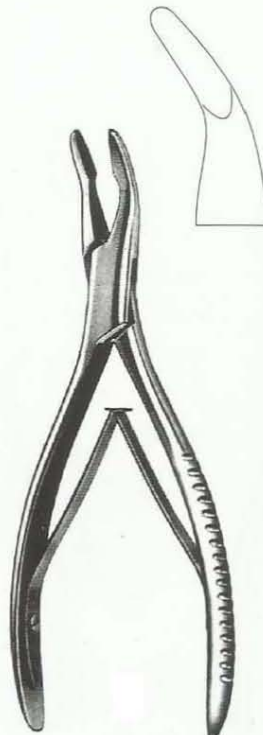

Mead
786-295
16.5 cm / 6½"

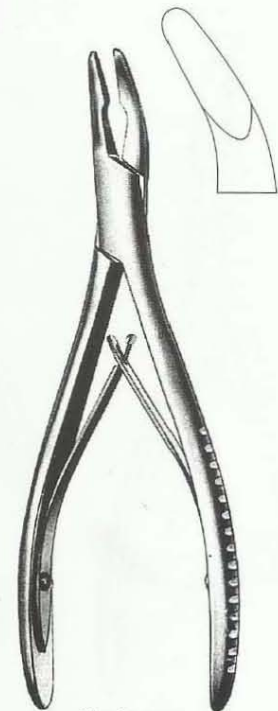

Hartmann
786-296
18.5 cm / 7¼"

Bone Rongeur Forceps
Hohlmeißelzangen
Pinzas-gubias

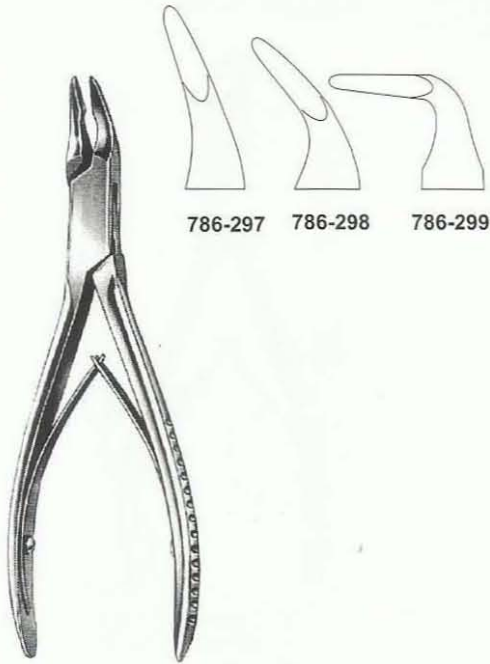

786-297 786-298 786-299

Blumenthal
15 cm / 6"

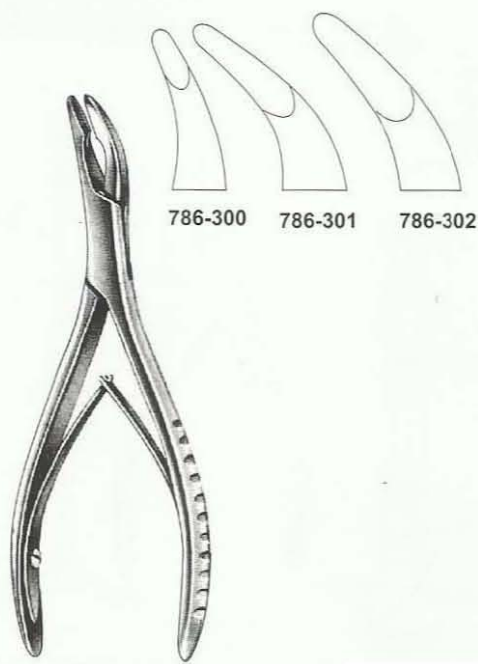

786-300 786-301 786-302

Luer
15 cm / 6"

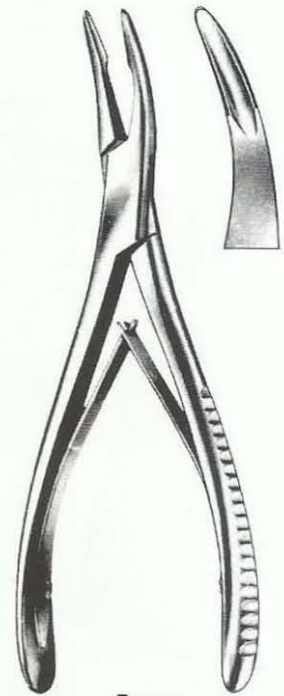

Beyer
786-303
18 cm / 7"

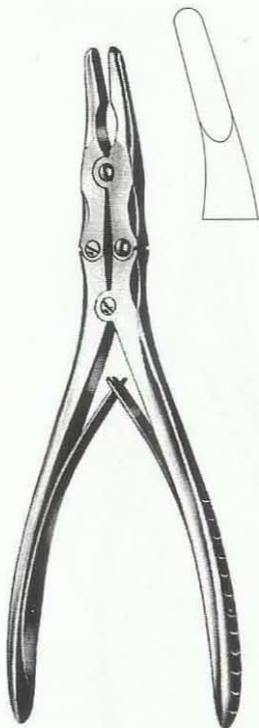

Zaufal-Jansen
786-304
18 cm / 7"

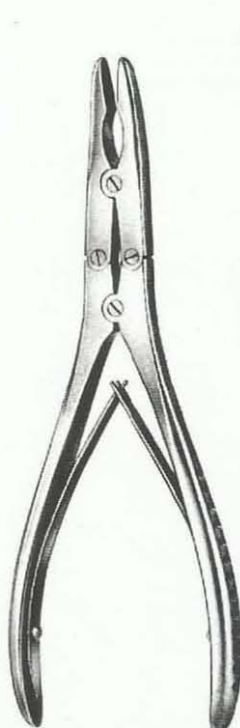

Ruskin

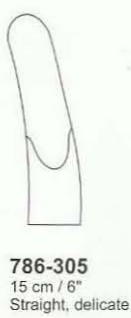

786-305
15 cm / 6"
Straight, delicate



786-306
18 cm / 7"
Straight



786-307
18 cm / 7"
Curved



Kerrison
786-308
15 cm / 6"

Bone Rongeur Forceps
Hohlmeißelzangen
Pinzas-gubias

Bone / Soft tissue nipper

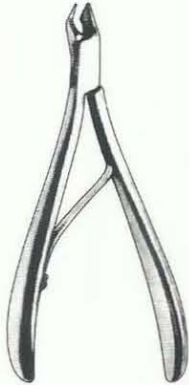

Goldman-Fox
786-309
10 cm / 4"
Small beak for use in
limited-access areas

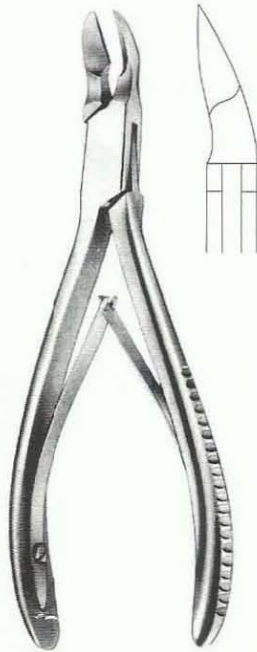

Cleveland
786-310
17 cm / 6 3/4"



Cleveland
786-311
15 cm / 6"

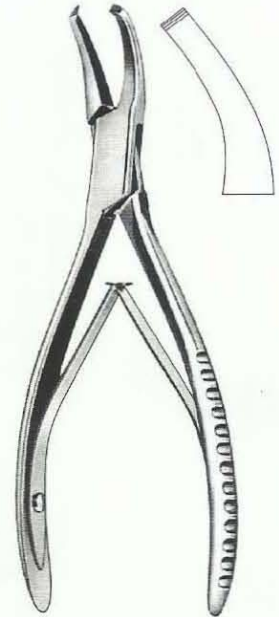

Cleveland
786-312
16 cm / 6 1/4"

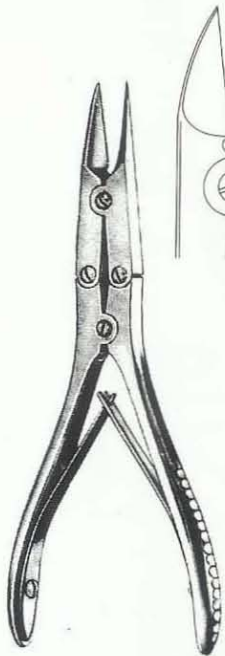

786-313
15 cm / 5 1/4"

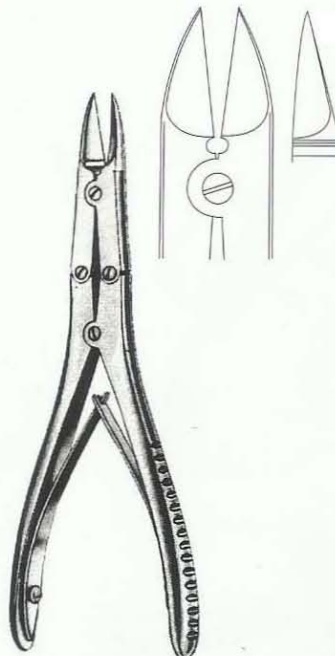

786-314
15 cm / 5 3/4"

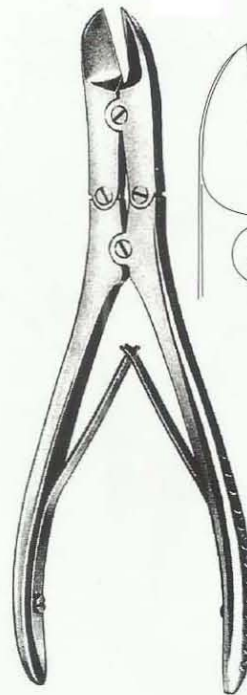

Ruskin-Liston
18.5 cm / 7 1/4"

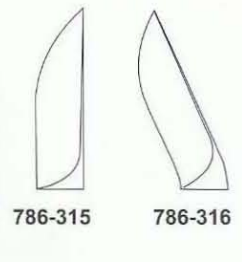

786-315

786-316

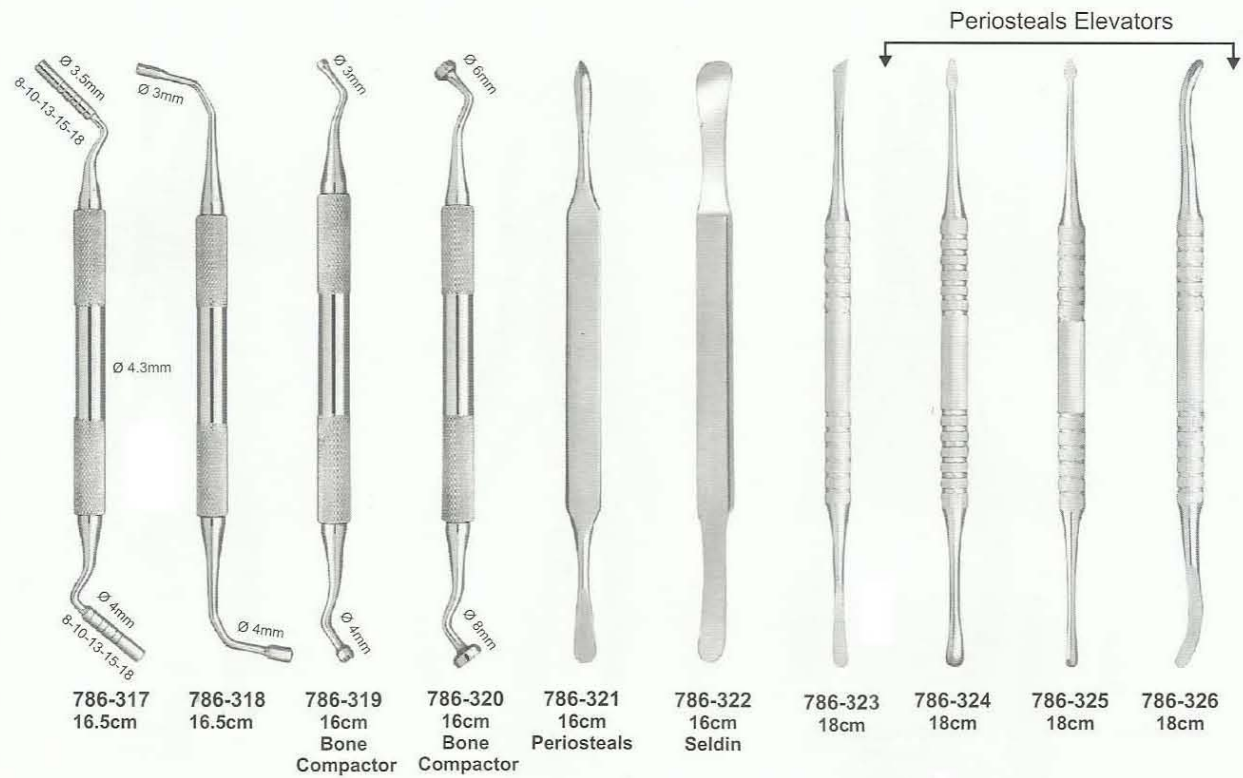

Also Available
 In Customize
 Sizes

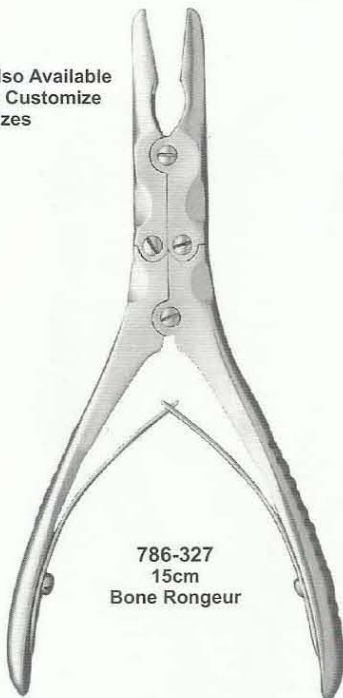

Also Available
 In Customize
 Sizes

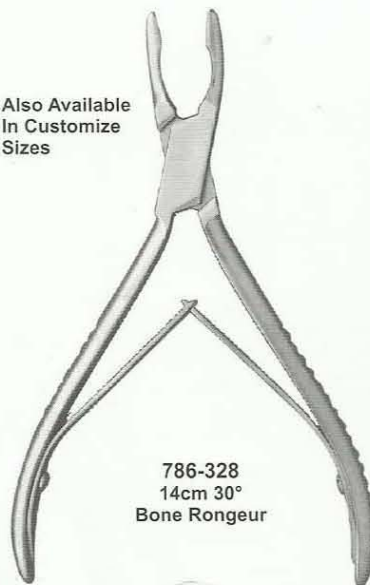

786-329
14cm 90°
Root Forcep

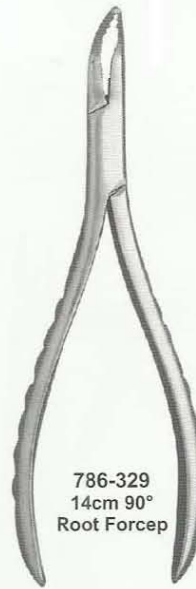

786-330
14cm 45°
Root Forcep

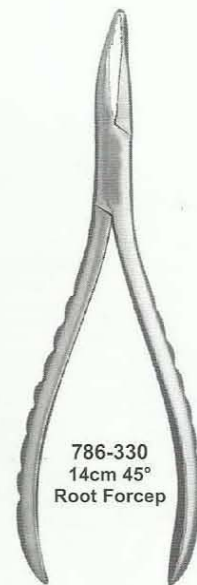

786-331
Ø 40mm
Bone Crusher (Large Bone)



786-332
Ø 25mm
18cm
Teflon Insert Mallet

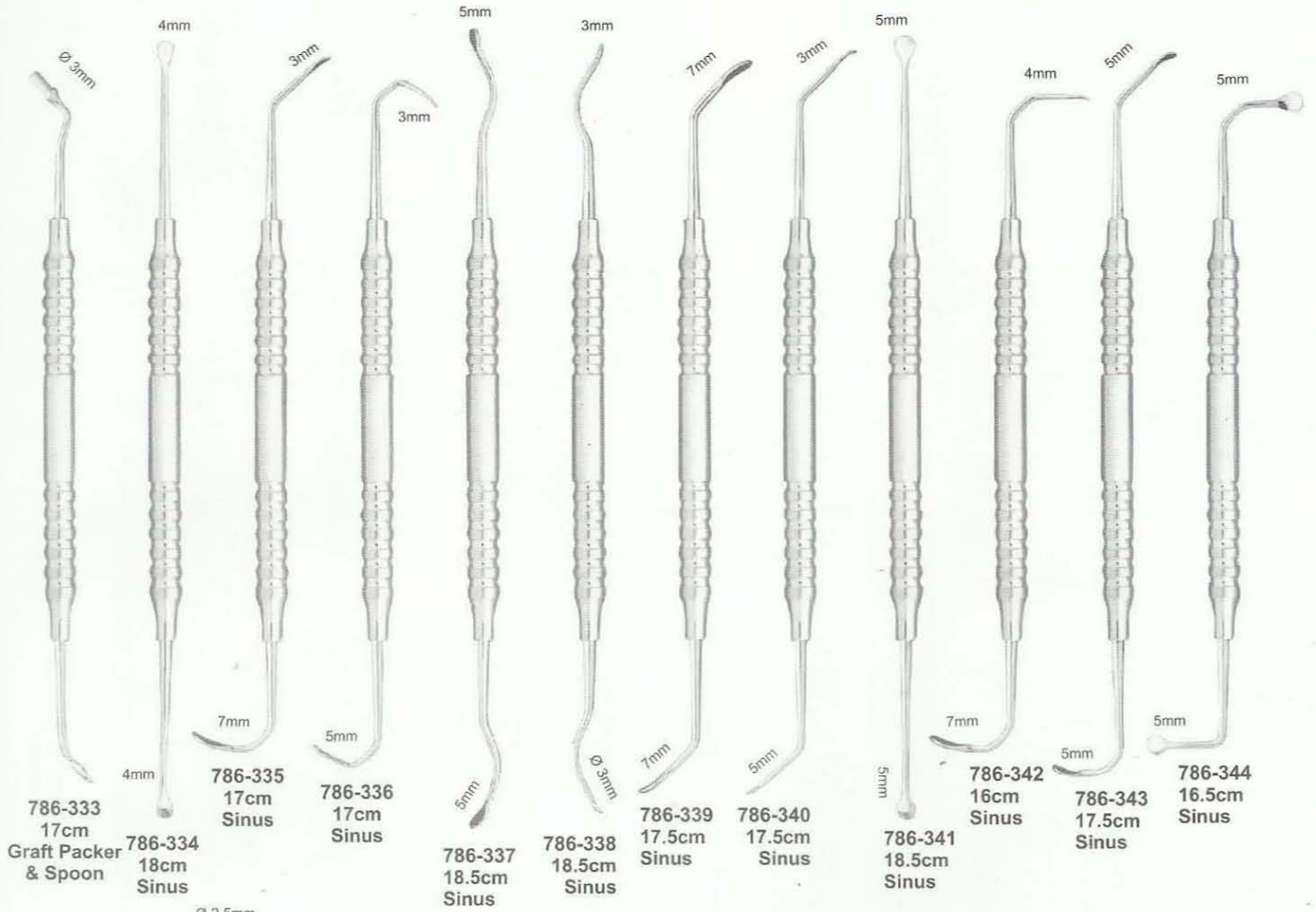

Ø 2.5mm
 Ø 4.4mm

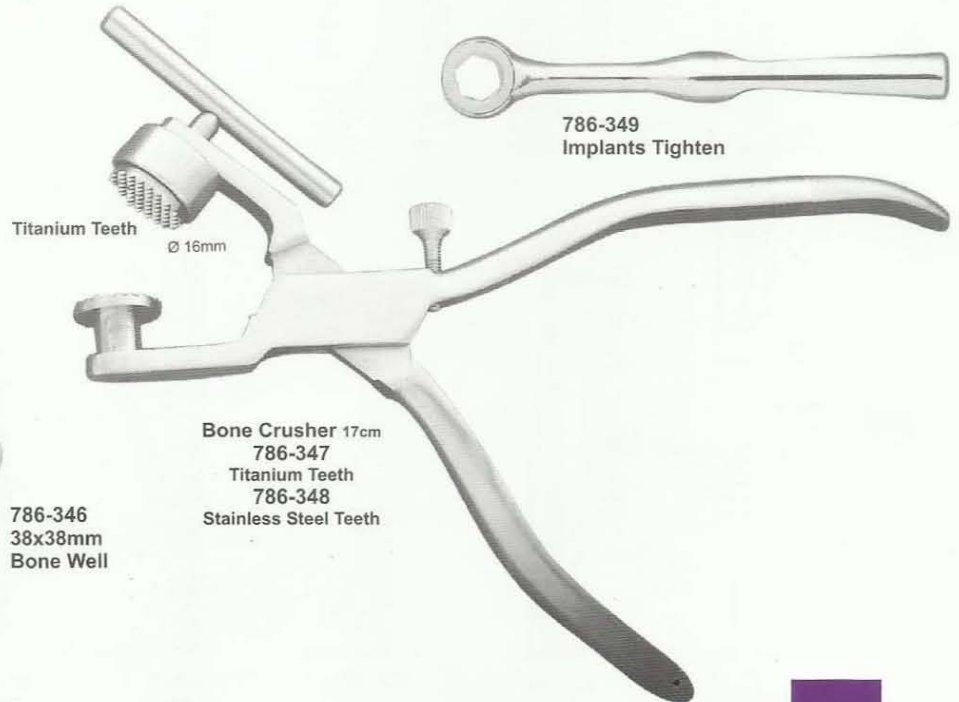



786-351
 Ø 2.8mm
 15.5cm



786-352
 Ø 3.5mm
 15.5cm



786-353
 Ø 4.5mm
 15.5cm



786-354
 Ø 2.8mm
 15.5cm



786-355
 Ø 3.5mm
 15.5cm



786-356
 Ø 4.3mm
 15.5cm



15.5cm

Also Available
 In Bespoke
 Design
 & Sizes



786-357
 Ø 4mm
 16cm
 Chisels

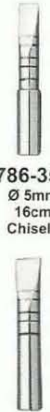

786-358
 Ø 5mm
 16cm
 Chisels

786-359
 Ø 6mm
 16cm
 Chisels

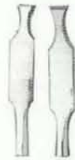

786-360
 Ø 6mm
 16cm
 Chisels



786-361
 Ø 6mm
 16cm
 Chisels

PERIOTOME

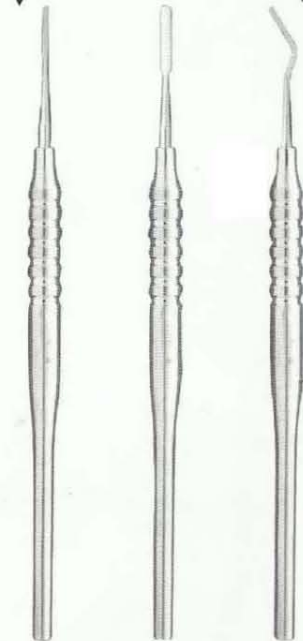

786-362
 15.5cm

786-363
 15.5cm

786-364
 15.5cm



786-365
 15.5cm
 Twin Sided
 Mirror



786-366
 15.5cm
 CP-15



Ø 4mm
 Ø 5mm
 Ø 6mm

786-367
 10cm
 Tissue punch



Ø 4mm
 Ø 5mm
 Ø 6mm

786-368
 10cm
 Tissue punch



786-369
 Syringe



786-370
 Syringe



786-371
 Syringe

EXTRACTIVE



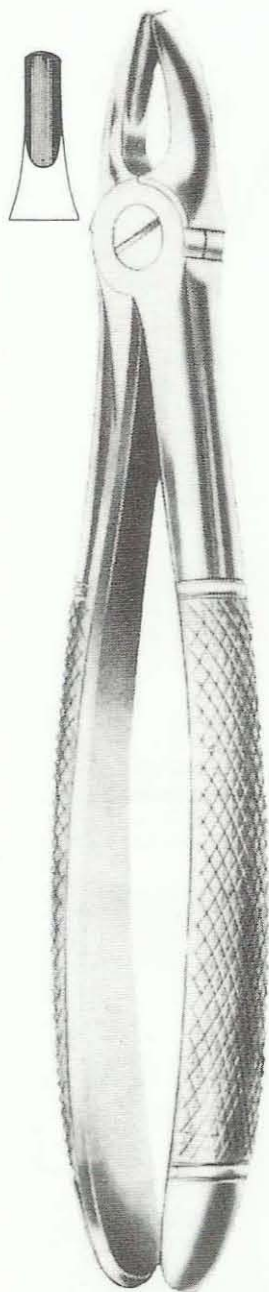

786-396
Fig:1
obere Schneide - und Eckzähne
upper centrals and canines
incisives et canines supérieures
incisives y caninos superiores

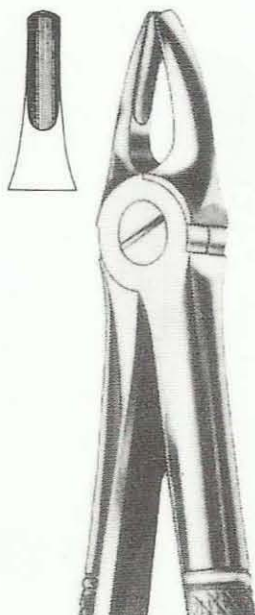

786-397
Fig:2
obere Schneide - und Eckzähne
upper laterals and canines
incisives et canines supérieures
incisives y caninos superiores



786-398
Fig:3
obere Schneide - und Eckzähne
upper incisors and canines
incisives et canines supérieures
incisives y caninos superiores

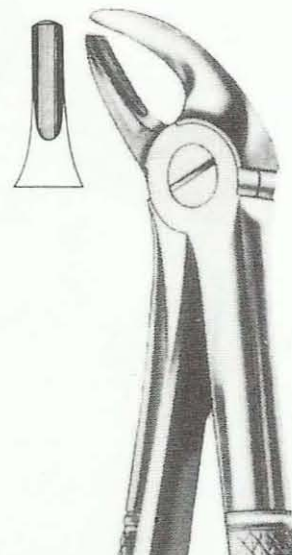

786-399
Fig:4
untere Schneide - und Eckzähne
lower incisors and canines
incisives et canines inférieures
incisives y caninos inferiores

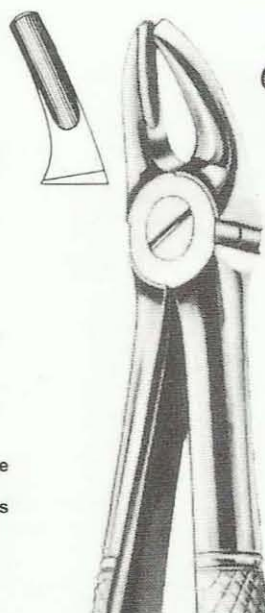

786-400
Fig:7
obere Prämolaren
upper premolars
prémolaires supérieures
premolares superiores

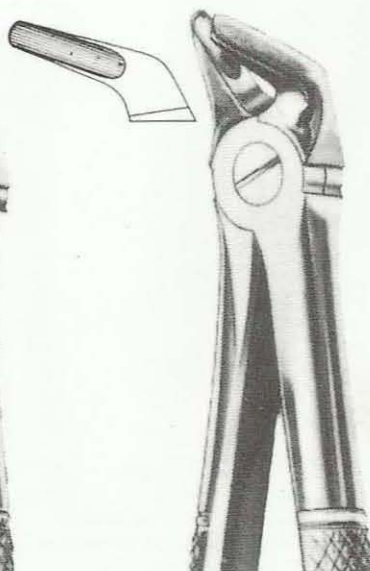

786-401
Fig:8
obere Prämolaren
lower premolars
prémolaires inférieures
premolares inferiores



786-402
Fig:13
untere Prämolaren
lower premolars
prémolaires inférieures
premolares inferiores

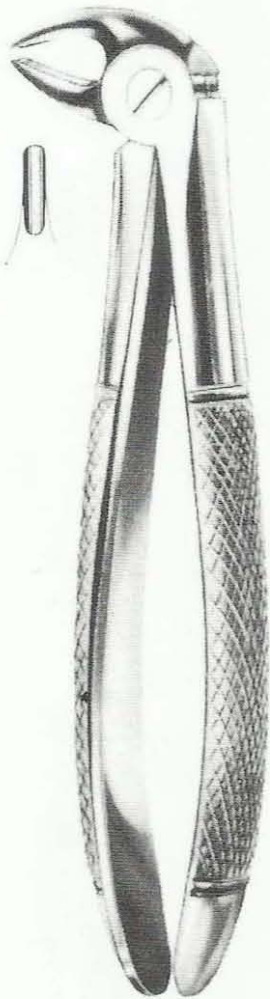

786-403
Fig:13S
untere Prämolaren
für Kinder
lower premolars
for children
prémolaires inférieures,
pour enfants
premolares inferiores,
para niños

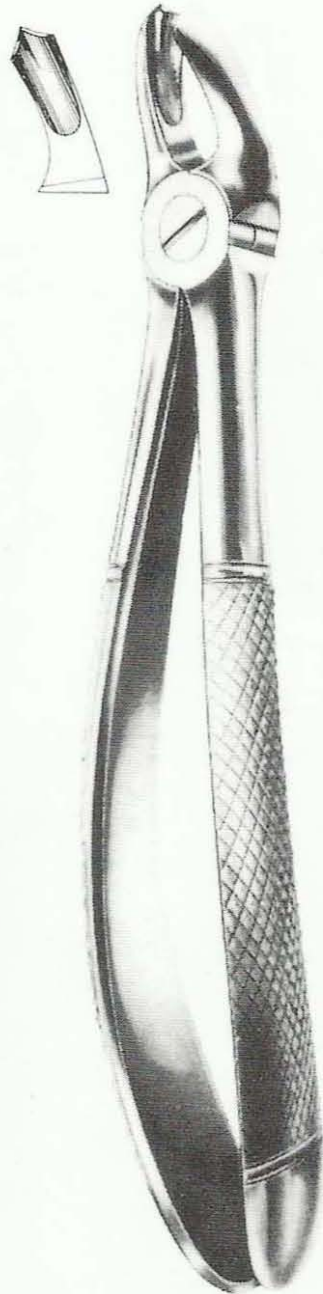

786-404
Fig:17
obere Molaren, rechts
upper molars, right
molaires supérieures droites
molares superiores derechos

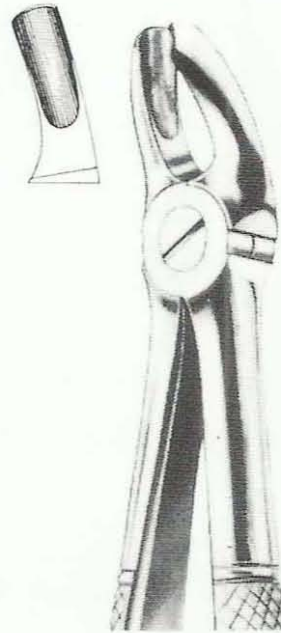

786-405
Fig:18
obere molaren, links
upper molars, left
molaires supérieures gauches
molares superiores izquches

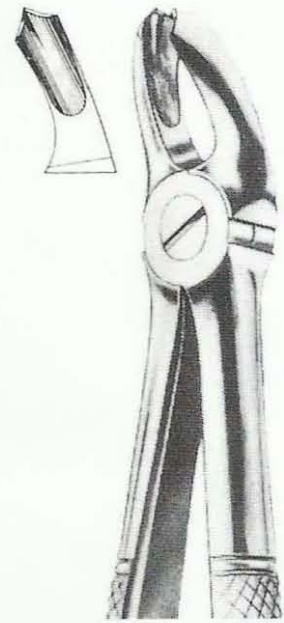

786-406
Fig:18A
obere Molaren
upper molars
molaires supérieures
molares superiores

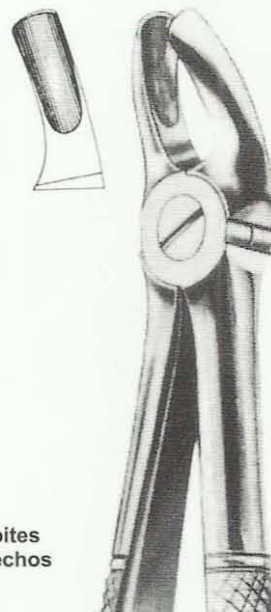

786-407
Fig:18B
obere Molaren
upper molars
molaires supérieures
molares superiores

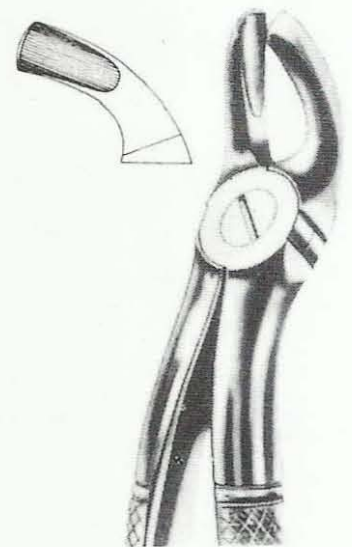

786-408
Fig:19
obere dritte Molaren
upper third molars
troisième molaires supérieures
terceros molares superiores

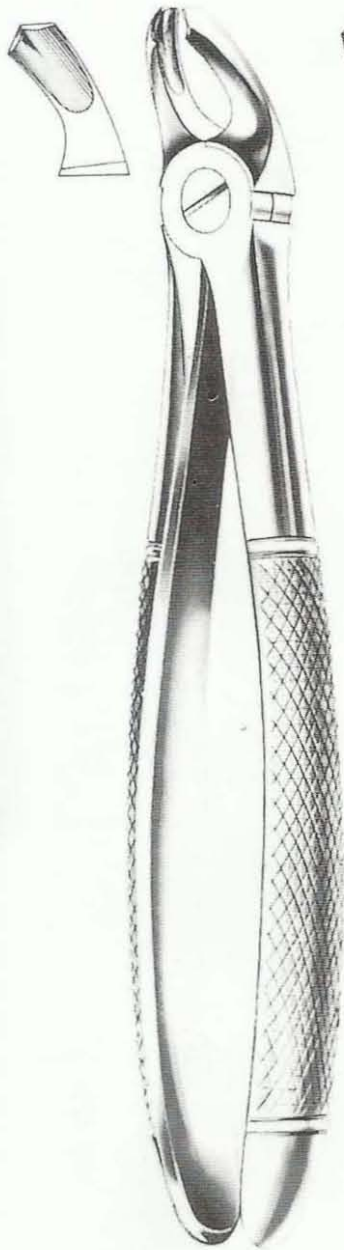

786-409
Fig:20
untere dritte Molaren
lower third molars
troisièmes molaires inférieures
terceros molares inferiores

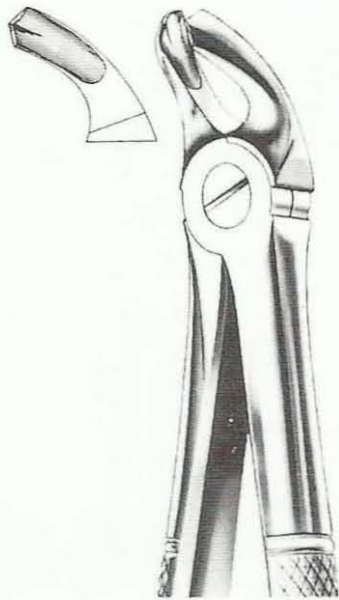

786-410
Fig:21
untere Molaren
lower molars
molaires inférieures
molares inferiores

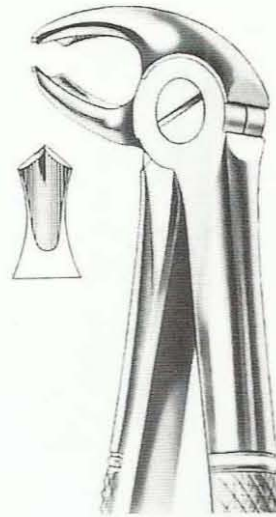

786-411
Fig:22
untere Molaren
lower molars
molaires inférieures
molares inferiores

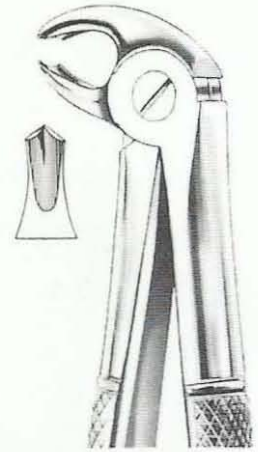

786-412
Fig:22S
untere Molaren,
für Kinder
lower molars,
for children
molaires inférieures,
pour enfants
molares inferiores,
para niños

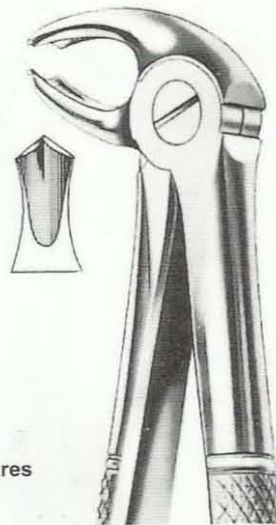

786-413
Fig:22G
untere Molaren
lower molars
molaires inférieures
molares inferiores

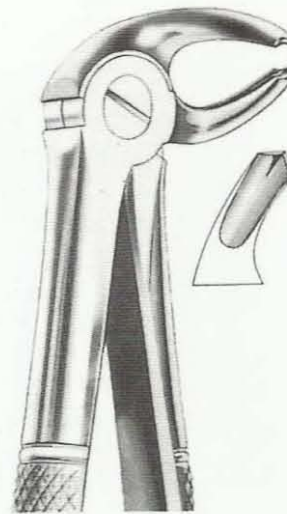

786-414
Fig:23
untere Molaren, rechts
lower molars, right
molaires inférieures
droites
molares inferiores
derechos

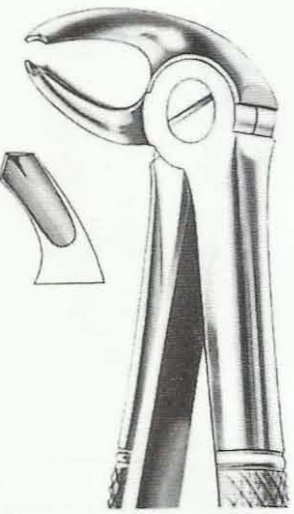

786-415
Fig:24
untere Molaren, links
lower molars, left
molaires inférieures
gauches
molares inferiores
izquierdos

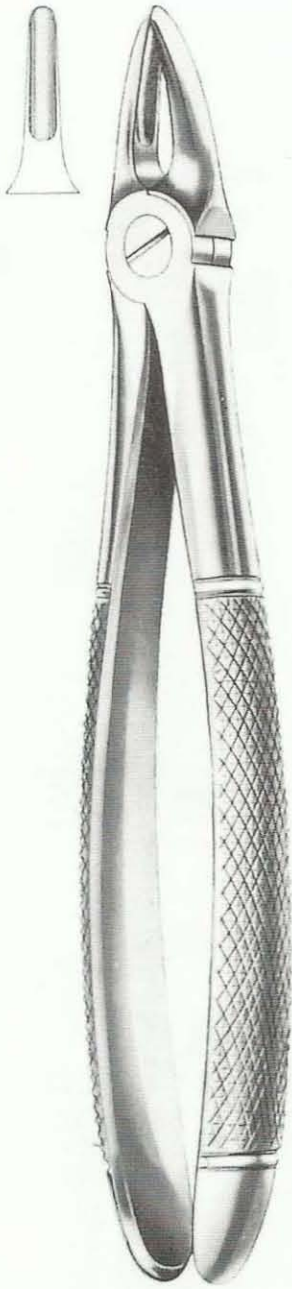

786-416
Fig:29
obere Wurzein,
upper roots,
racines supérieures,
raices superiores,

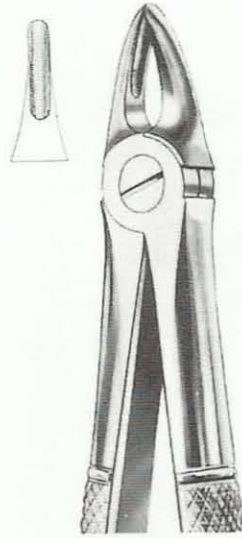

786-417
Fig:29S
obere Wurzein,
für Kinder
upper roots,
for children
racines supérieures,
pour enfants
raices superiores,
para niños

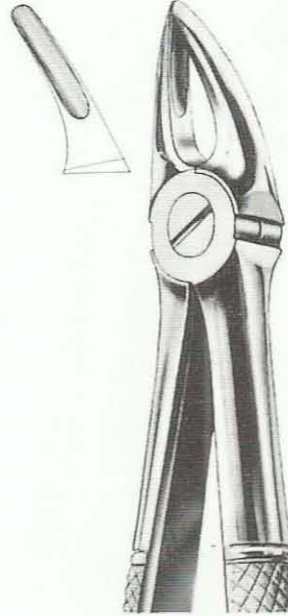

786-418
Fig:30
obere Wurzein,
upper roots,
racines supérieures,
raices superiores,

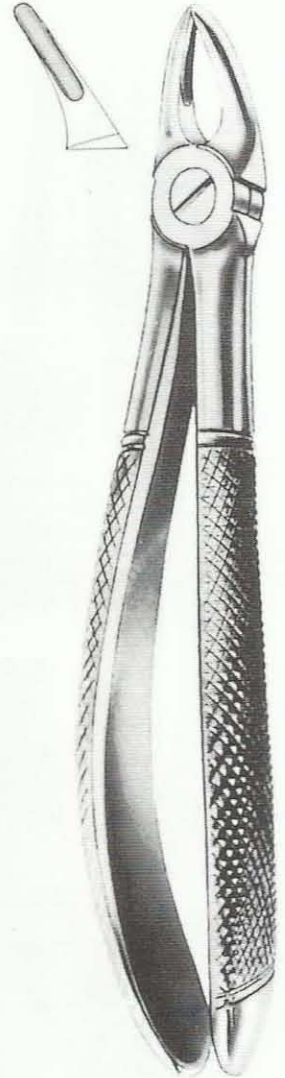

786-421
Fig:30S
obere Wurzein,
für Kinder
upper roots,
for children
racines supérieures,
pour enfants
raices superiores,
para niños

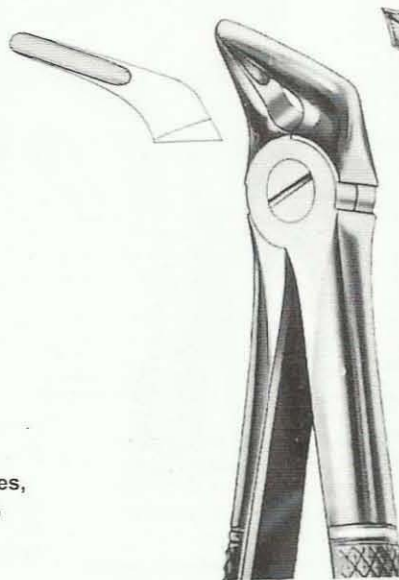

786-419
Fig:31
untere Wurzein,
lower roots,
racines inférieures
raices inferiores



786-420
Fig:32
untere Molaren
lower molars
molaires inférieures,
molares inferiores,



786-422
Fig:33
untere Wurzeln
lower roots
racines inférieures
raices inferiores

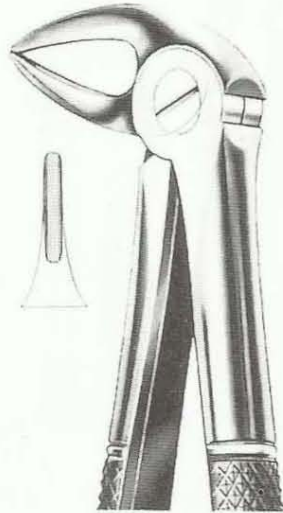

786-423
Fig:33A
untere Wurzeln
lower roots
racines inférieures
raices inferiores

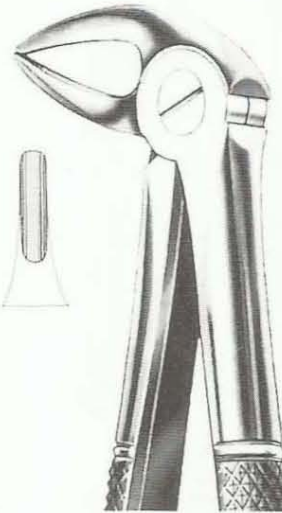

786-424
Fig:33B
untere Wurzeln
lower roots
racines inférieures
raices inferiores

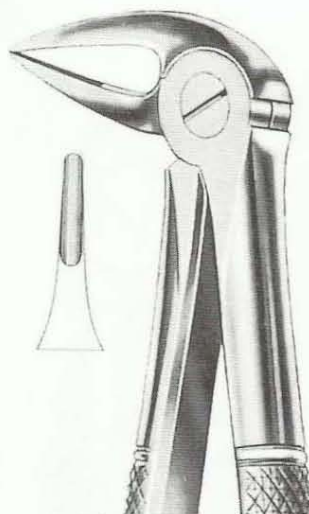

786-425
Fig:33L
untere Wurzeln
lower roots
racines inférieures
raices inferiores

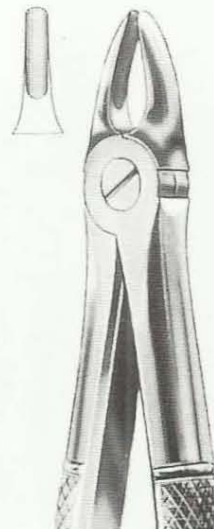

786-426
Fig:37
obere Schneidezähne
für Kinder
upper incisors
for children
incisives supérieures,
pour enfants
incisivos superiores,
para niños

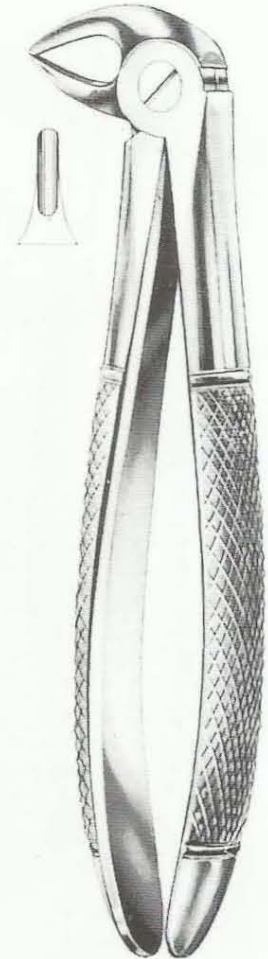

786-427
Fig:33S
untere Wurzeln
für Kinder
lower roots
for children
racines inférieures,
pour enfants
raices inferiores,
para niños

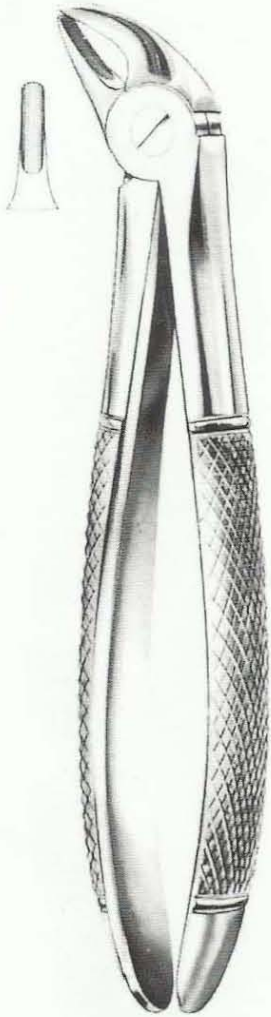

786-428
Fig:38
untere Schneide-und
Eckzähne, für Kinder
lower incisors and
canines, for children
incisives et canines
inférieures pour enfants
incisivos y caninos
inferiores, para niños

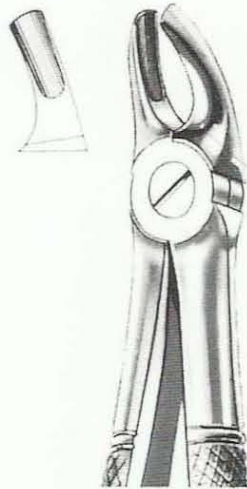

786-429
Fig:39
obere Molaren,
für Kinder
upper molars
for children
molaires supérieures
pour enfants
molares superiores
para niños

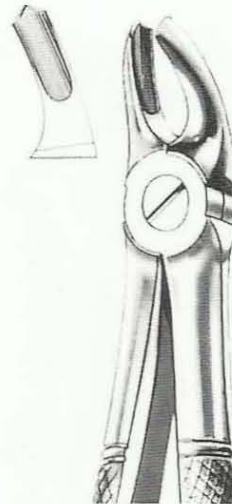

786-430
Fig:39R
obere Molaren rechts,
für Kinder
upper molars right,
for children
molaires supérieures
droites, pour enfants
molares superiores
derechos, para niños

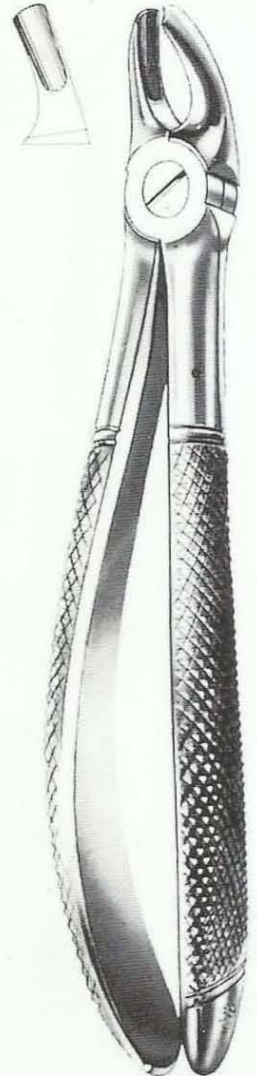

786-433
Fig:39L
obere Molaren links
für Kinder
upper molars left,
for children
molaires supérieures gauches
pour enfants
molares superiores izquierdos
para niños

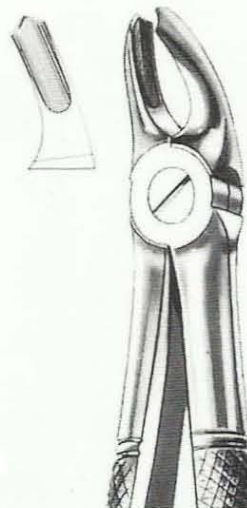

786-431
Fig:39A
obere Molaren,
für Kinder
upper molars,
for children
molaires supérieures,
pour enfants
molares superiores,
para niños

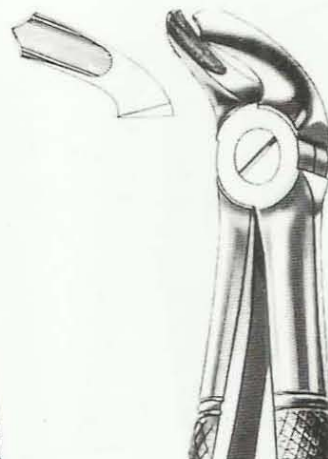

786-432
Fig:40
untere Molaren,
für Kinder
lower molars,
for children
molaires inférieures,
pour enfants
molares inferiores,
para niños

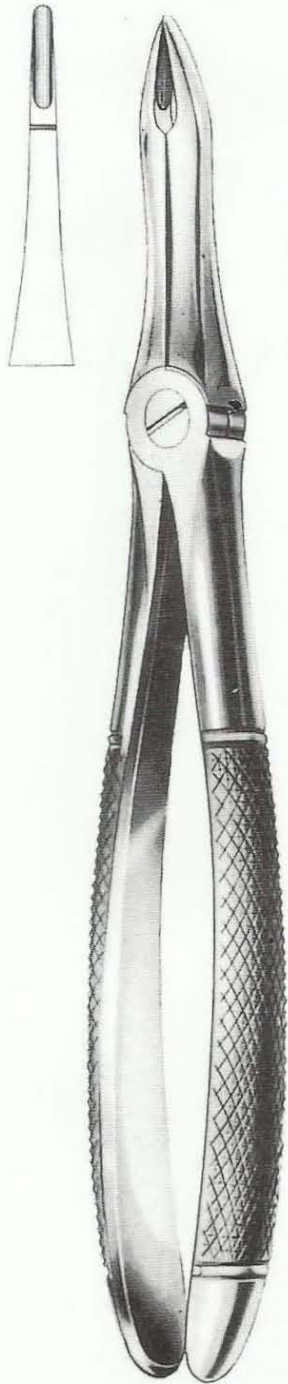

786-434
Fig:41
obere Wurzeln
upper roots
racines supérieures
raices superiores

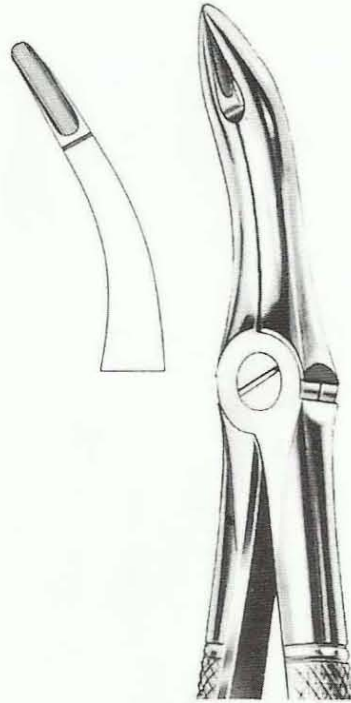

786-435
Fig:44
obere Wurzeln
upper roots
racines supérieures
raices superiores

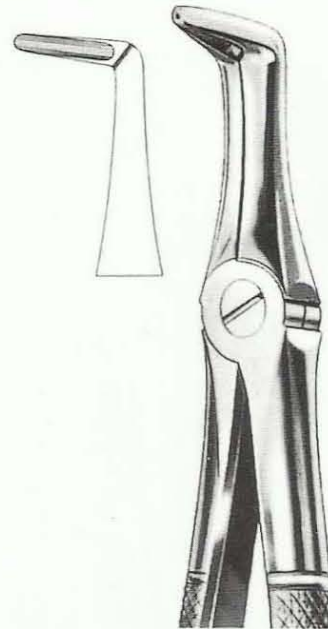

786-436
Fig:45
untere Wurzeln
lower roots
racines inférieures
raices inferiores

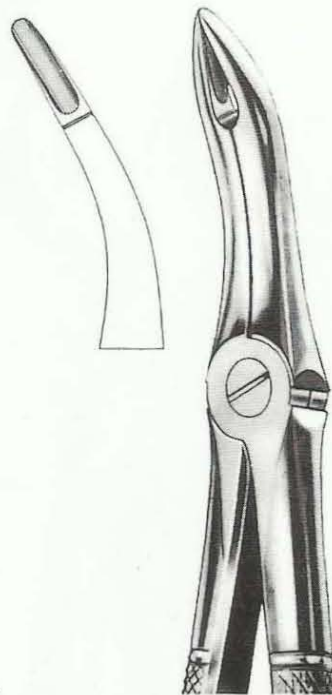

786-437
Fig:48
untere Wurzeln
lower roots
racines inférieures
raices inferiores

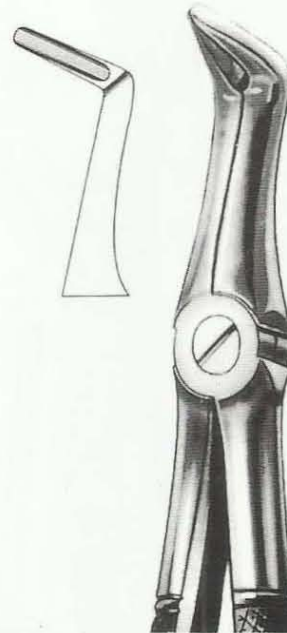

786-438
Fig:49
obere Wurzeln
upper roots
racines supérieures
raices superiores

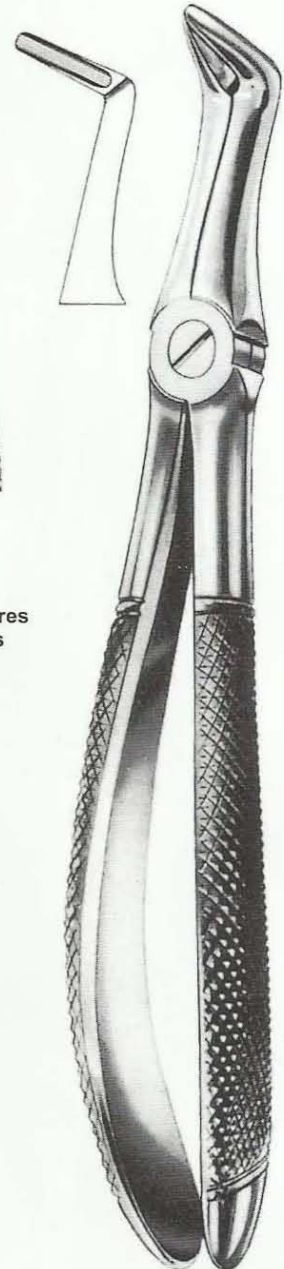

786-439
Fig:50
obere Wurzeln
upper roots
racines supérieures
raices superiores

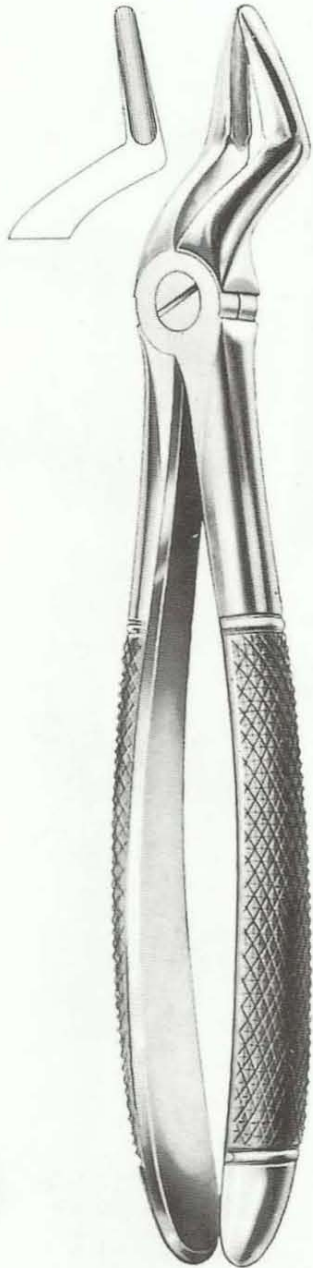

786-440
Fig:51
obere Wurzein,
upper roots,
racines supérieures,
raices superiores,

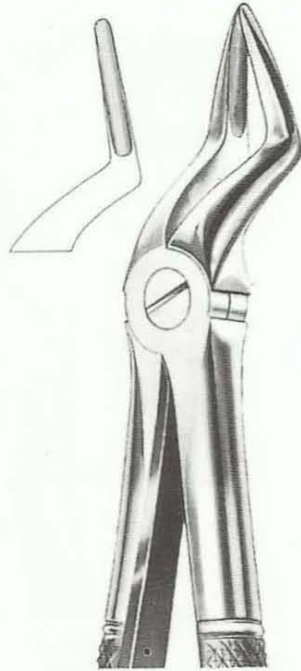

786-441
Fig:51A
obere Wurzein,
upper roots,
racines supérieures,
raices superiores,

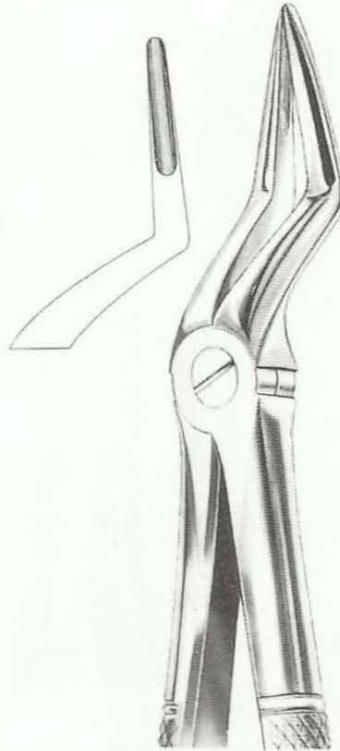

786-442
Fig:51L
obere Wurzein,
upper roots,
racines supérieures,
raices superiores,

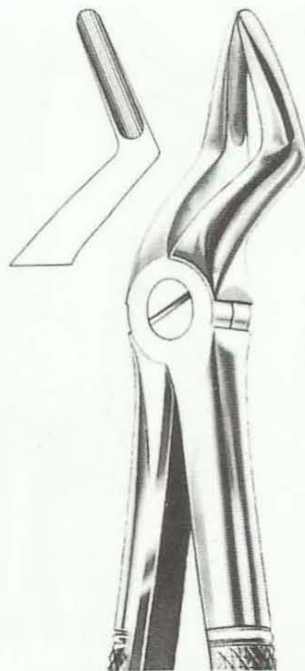

786-443
Fig:52
obere Wurzein,
upper roots,
racines supérieures,
raices superiores,

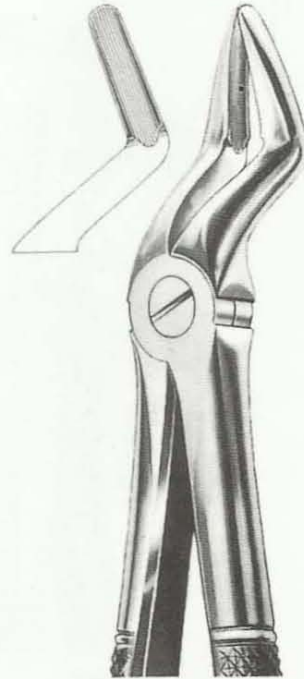

786-444
Fig:52A
obere Zähne und Resektion
upper teeth and resection
dents supérieures et résection
dientes superiores y resección

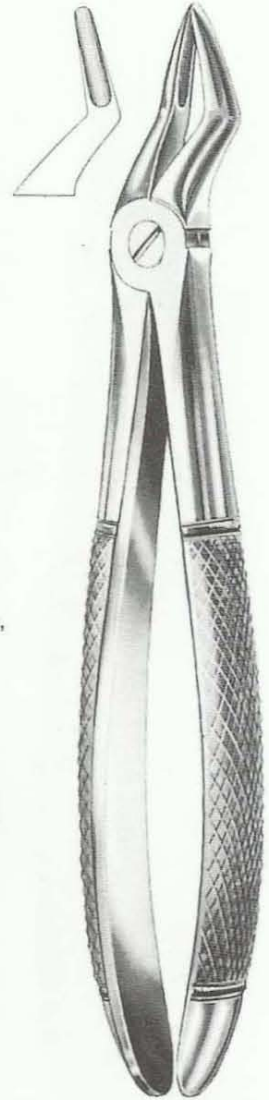

786-445
Fig:51S
obere Wurzein,
für Kinder
upper roots,
for children
racines supérieures,
pour enfants
raices superiores,
para niños

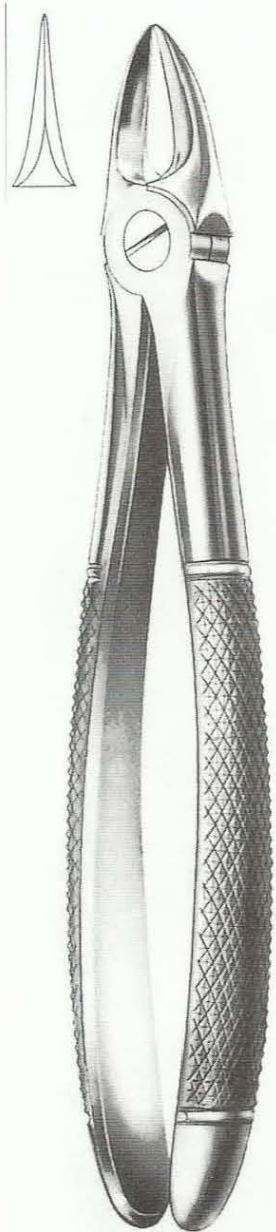

786-446
Fig:54
Spaltzange für oben
Molaren
for separating upper molars
à séparer molaires
supérieures
para separar molares
superiores

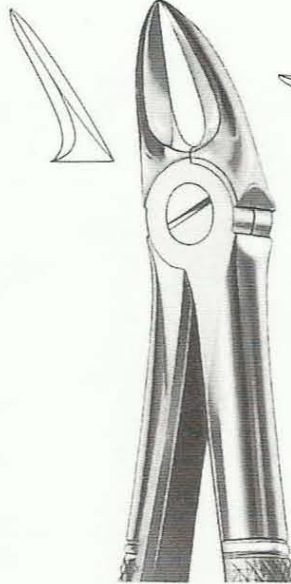

786-447
Fig:55
Spaltzange für obere
Molaren
for separating upper molars
à séparer molaires
supérieures
para separar molares
superiores

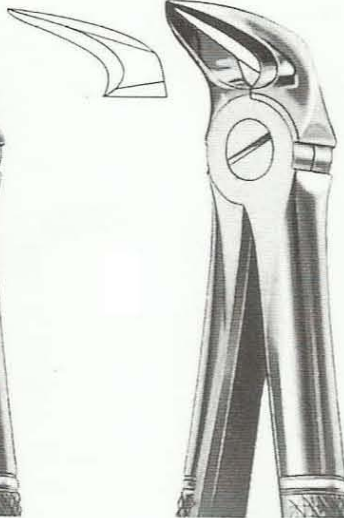

786-448
Fig:56
Spaltzange für untere
Molaren
for separating lower molars
à séparer molaires
inférieures
para separar molares
inferiores

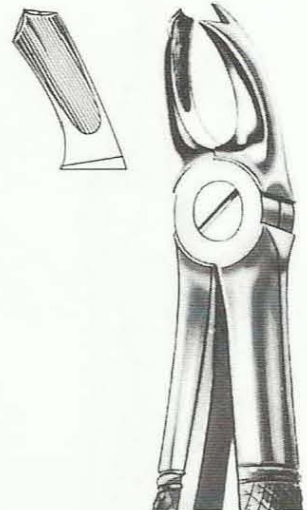

786-449
Fig:65R
obere Molaren, rechts
upper molars, right
molaires supérieures
droites
molares superiores
derechos

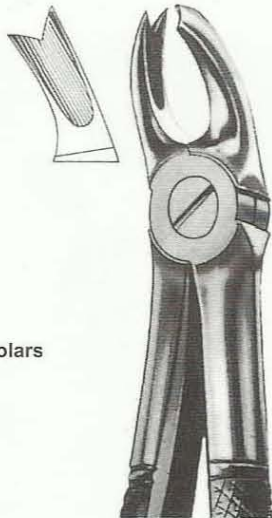

786-450
Fig:65L
obere Molaren, links
upper molars, left
molaires supérieures
gauches
molares superiores
izquierdos

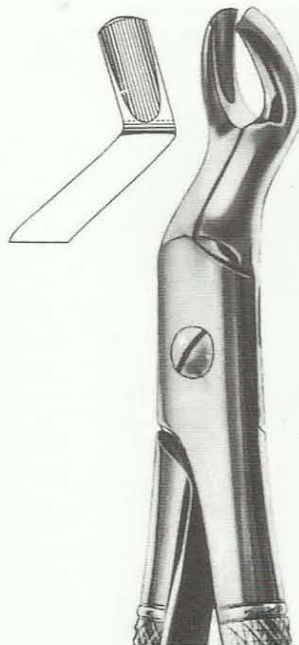

786-451
Fig:67
obere dritte Molaren
upper third molars
troisièmes molaires
supérieures
terceros molares
superiores

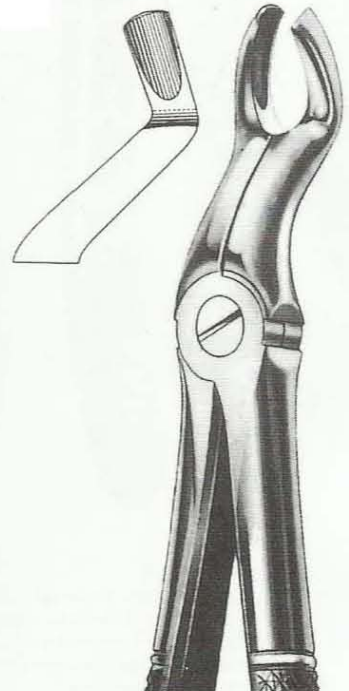

786-452
Fig:67A
obere dritte Molaren
upper third molars
troisièmes molaires
supérieures
terceros molares
superiores

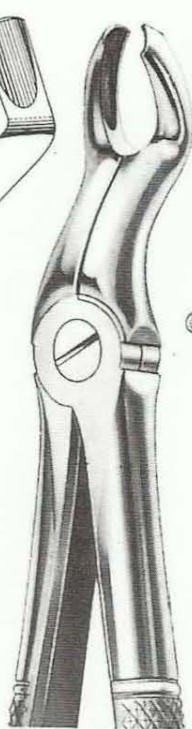
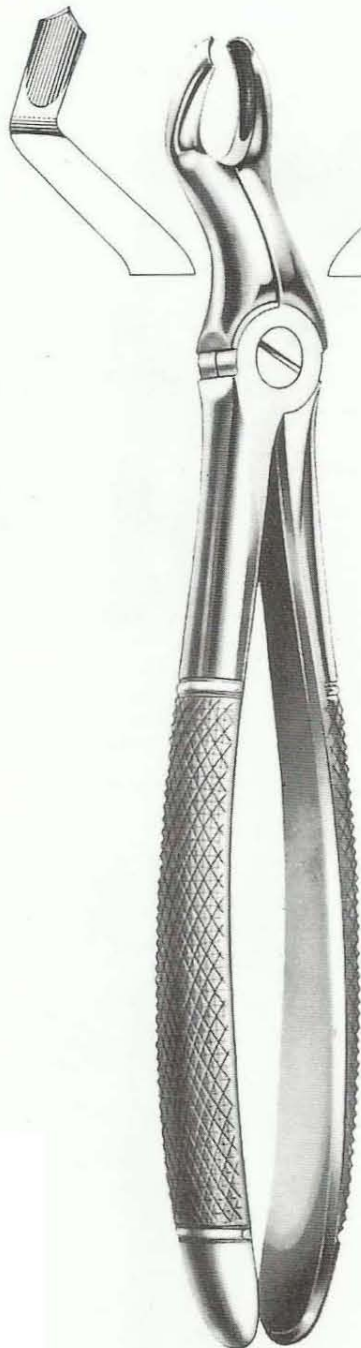

786-454
Fig:67½L
obere dritte Molaren, links
upper third molars, left
troisièmes molaires
supérieures, gauches
terceros molares
superiores, izquierdos

786-455
Fig:68
untere Wurzeln
lower roots
racines inférieures
raices inferiores

786-456
Fig:68A
untere Wurzeln
lower roots
racines inférieures
raices inferiores

786-453
Fig:67½R
obere dritte Molaren, rechts
upper third molars, right
troisièmes molaires
supérieures, droites
terceros molares
superiores, derechos

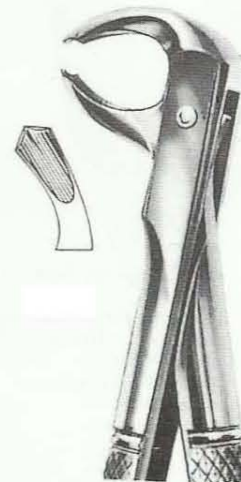
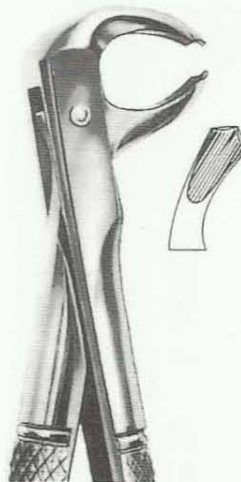
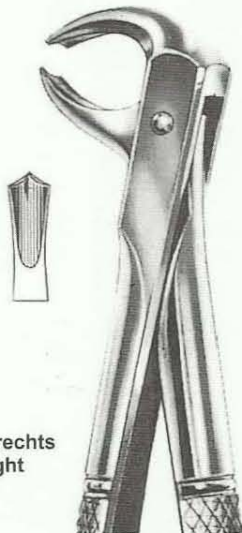

786-457
Fig:73
untere Molaren
lower molars
molaires inférieures
molares inferiores

786-458
Fig:73R
untere Molaren, rechts
lower molars, right
molaires inférieures
droites
molares inferiores
derechos

786-459
Fig:73L
untere Molaren, links
lower molars, left
molaires inférieures
gauches
molares inferiores
izquierdos

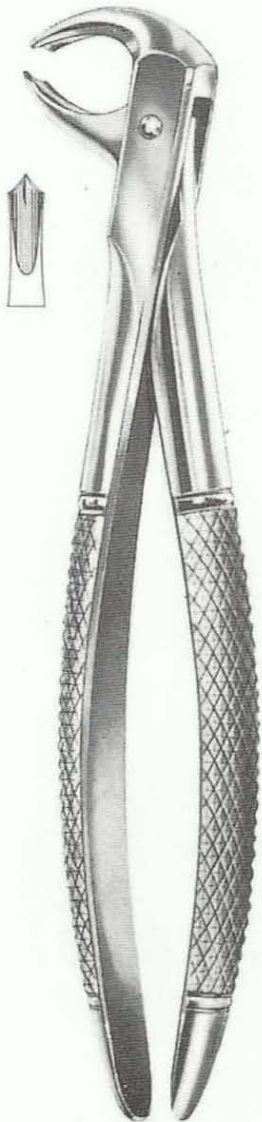

786-460
Fig:73A
untere Molaren
lower molars
molaires inférieures
molares inferiores

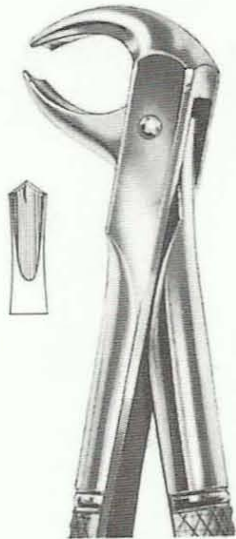

786-461
Fig:73S
untere Molaren
lower molars
molaires inférieures
molares inferiores

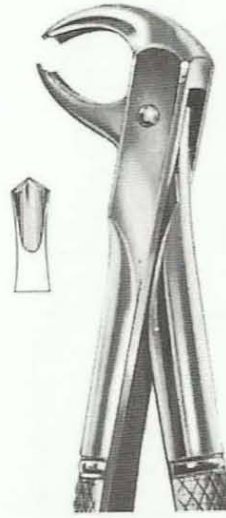

786-462
Fig:73B
untere Molaren,
für kinder
lower molars,
for children
molaires inférieures,
pour enfants
molares inferiores,
para niños

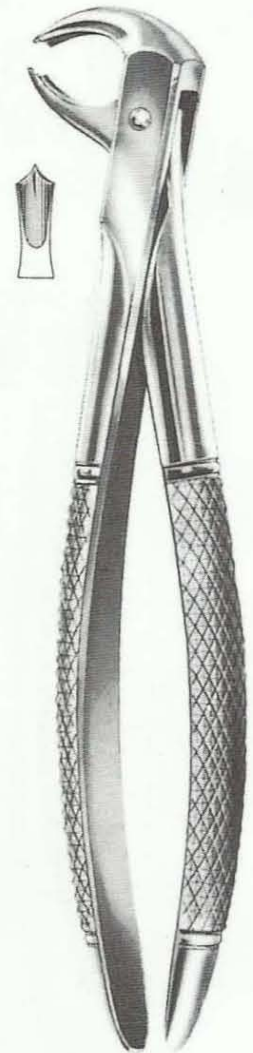

786-465
Fig:73K
untere Molaren,
für kinder
lower molars,
for children
molaires inférieures,
pour enfants
molares inferiores,
para niños

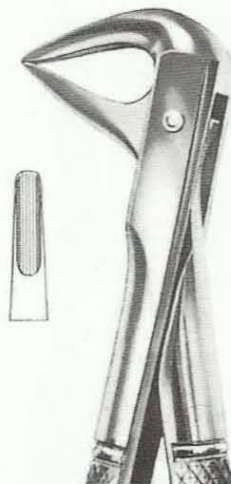

786-463
Fig:74
untere wurzeln
lower roots
racines inférieures
raices inferiores

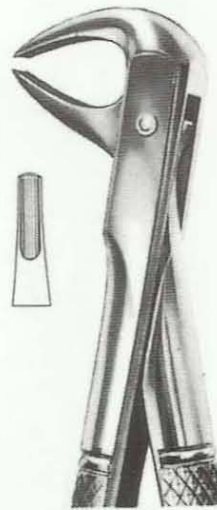

786-464
Fig:74D
untere wurzeln
lower roots
racines inférieures
raices inferiores

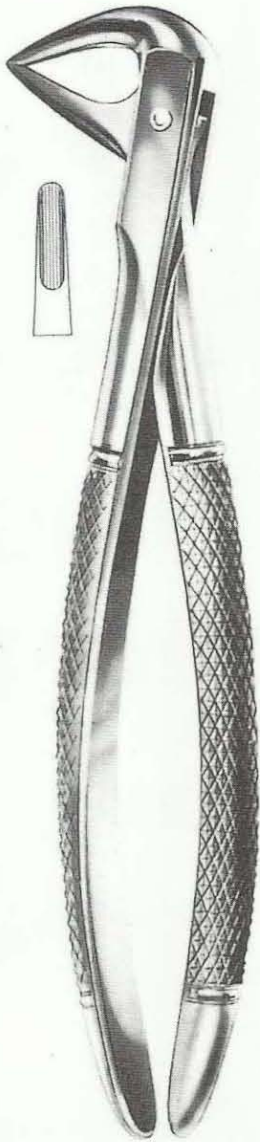

786-466
Fig:74M
untere wurzein
lower roots
racines inférieure
raices inferiores

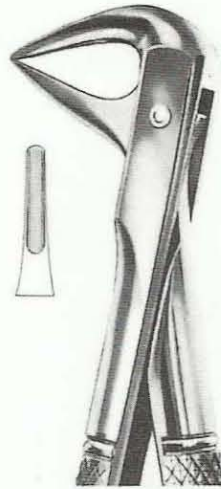

786-467
Fig:74N
Untere wurzein
Lower roots
Racines inférieures
Raices inferiores

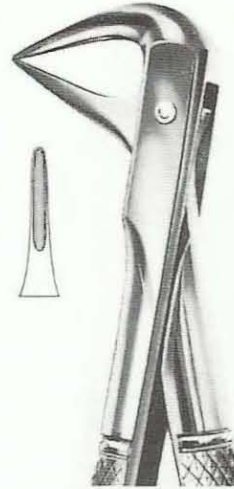

786-468
Fig:74XN
untere wurzein und eng-
stehende Schneidezahne
lower roots and crowded
incisors
racines inférieures et
incisives surdents
raices inferiores e incisivos
supernumerarios

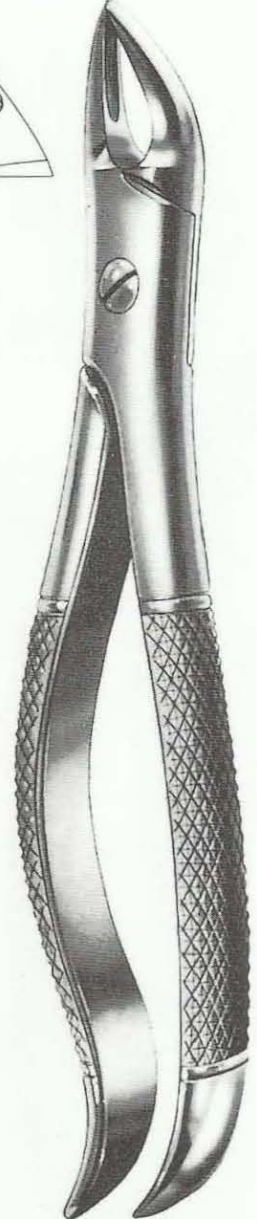
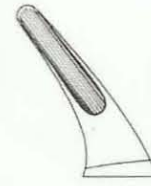

786-471
Fig:76N
obere wurzein
upper roots
racines supérieures
raices superiores

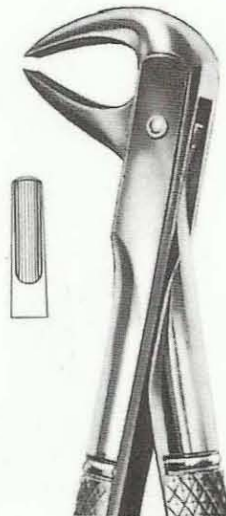

786-469
Fig:75
untere Pramolaren
lower Premolars
Premolaires inférieures
Premolares inferiores

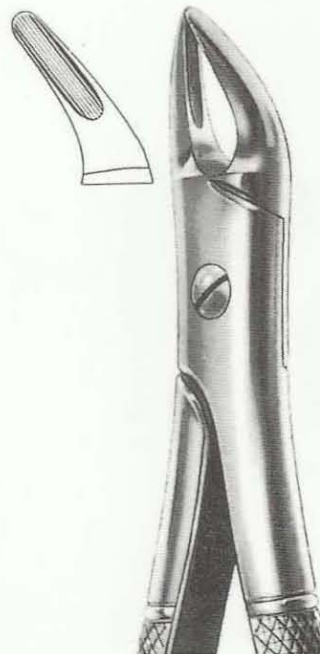

786-470
Fig:76
obere wurzein
upper roots
racines supérieures
raices superiores

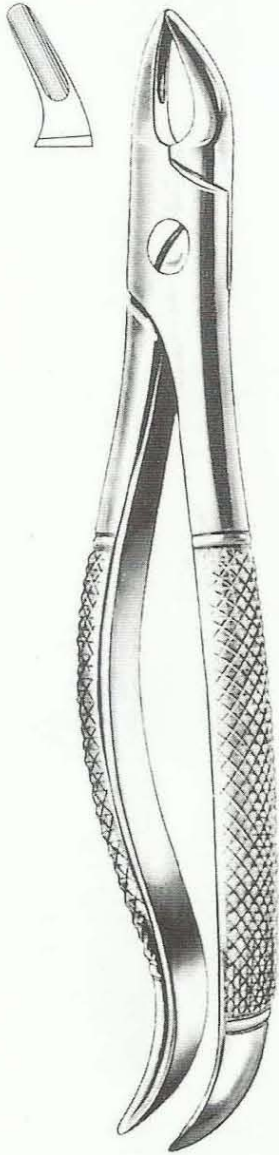

786-472
Fig:76S
obere wurzein
upper roots
racines supérieures
raices superiores

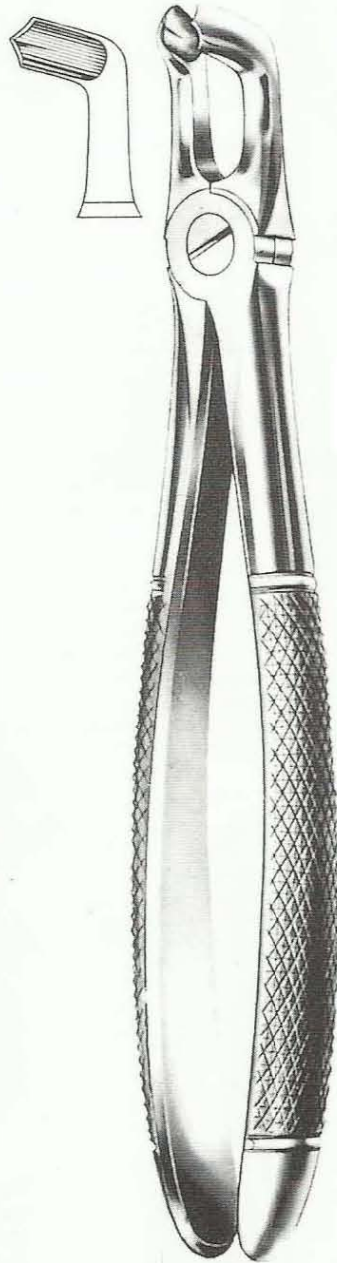

786-473
Fig:79
untere dritte Molaren
lower third molars
troisièmes molaires inférieures
terceros molares inferiores



786-474
Fig:79A
untere dritte Molaren
lower third molars
troisièmes molaires inférieures
terceros molares inferiores

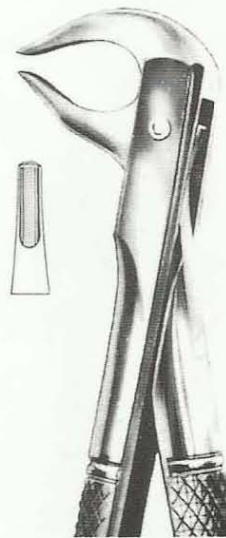

786-475
Fig:81
untere pramolaren
und Wurzein
lower permolars
and roots
prémolaires et racines
inférieures
premolares y raices
inferiores



786-476
Fig:80
Molarenwurzein oben
upper molar roots
racines de molaires supérieures
raices de molares superiores

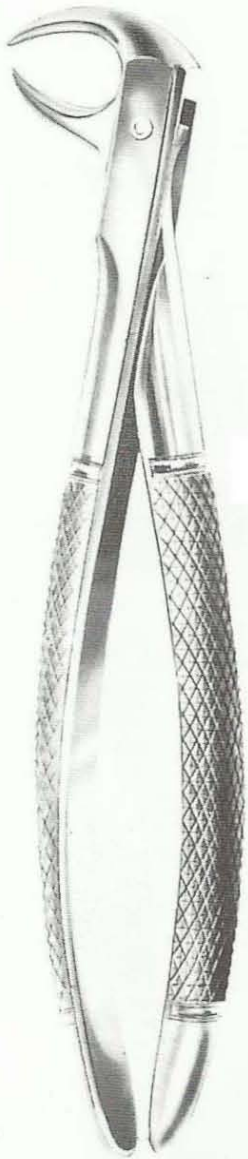

786-477
Fig:86A
untere Molaren
lower molars
molaires inférieures
molares inferiores

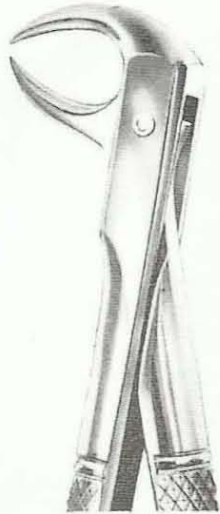

786-478
Fig:86B
untere Molaren
lower molars
molaires inférieures
molares inferiores

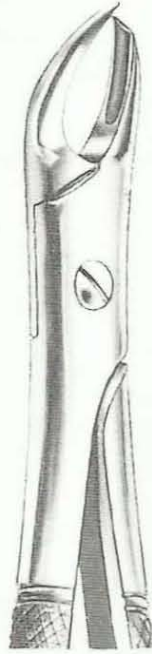

786-479
Fig:89
obere Molaren, rechts
upper molars, right
molaires supérieures droites
molares superiores derechos

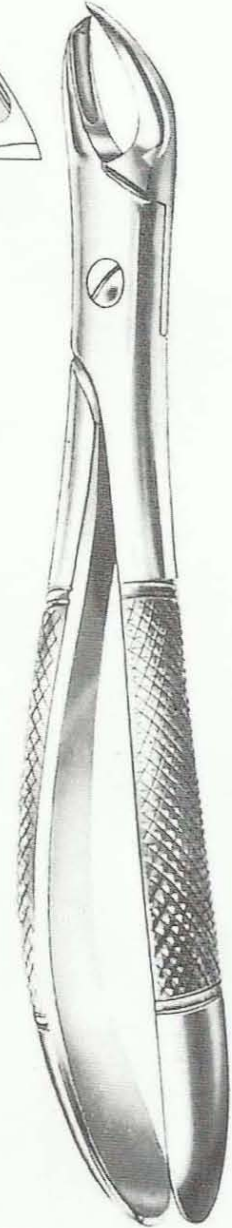
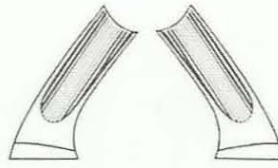

786-482
Fig:90
obere Molaren, links
upper molars, left
molaires supérieures gauches
molares superiores izquierdos

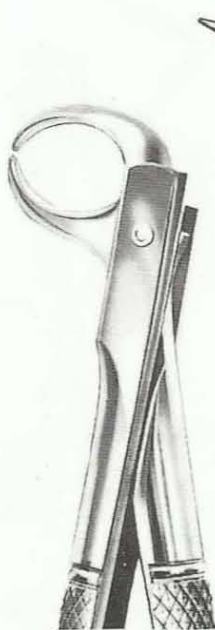

786-480
Fig:86C
untere Molaren
lower molars
molaires inférieures
molares inferiores

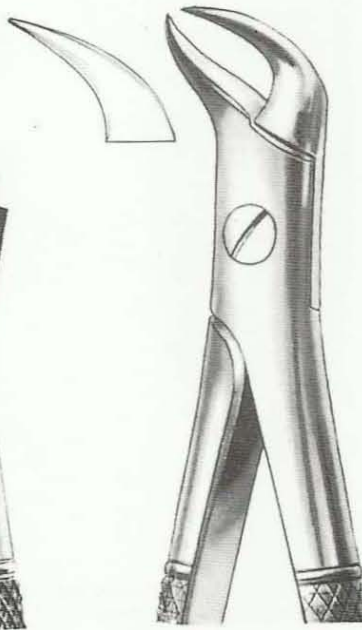

786-481
Fig:87
untere Molaren
lower molars
molaires inférieures
molares inferiores

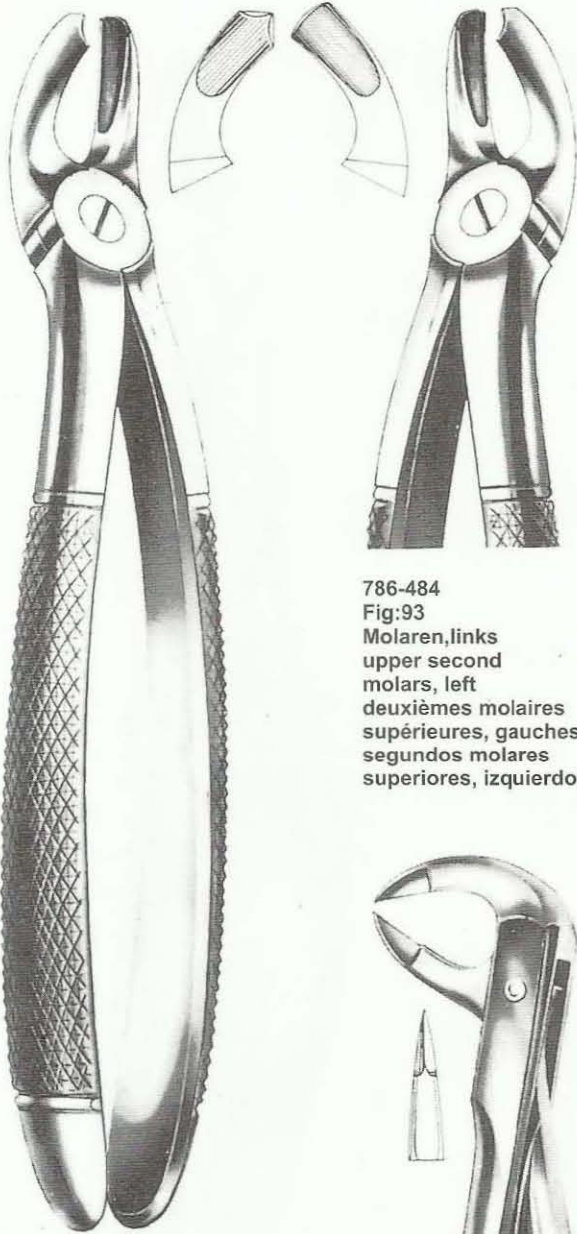

786-484
Fig:93
Molaren, links
upper second
molars, left
deuxièmes molaires
supérieures, gauches
segundos molares
superiores, izquierdos



786-485
Fig:94
obere Molaren, rechts
upper molars, right
molaires supérieures droites
molares superiores derechos

786-483
Fig:92
obere zweite
Molaren, rechts
upper second
molars, right
deuxièmes molaires

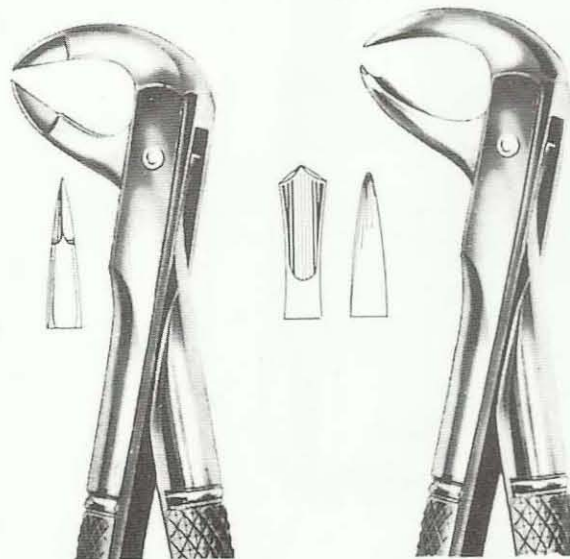

786-486
Fig:91
Spaltzange für untere
Molaren for separating
lower molars,
a séparer molaires
inférieures,
para separer molares
inferiores,

786-487
Fig:99
untere Molaren
lower molars
molaires inférieures
molares inferiores

786-488
Fig:95
obere Molaren, links
upper Molars, left
molaires supérieures, gauches
molares superiores, izquierdos

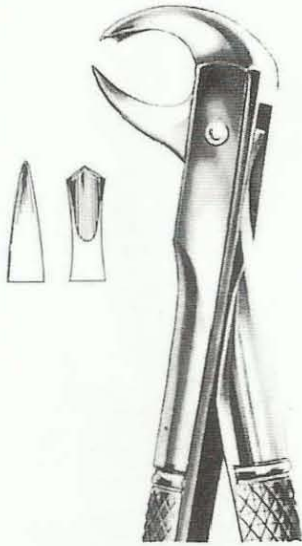

786-489
Fig:99¼
untere Molaren
lower molars
molaires inférieures
molares inferiores

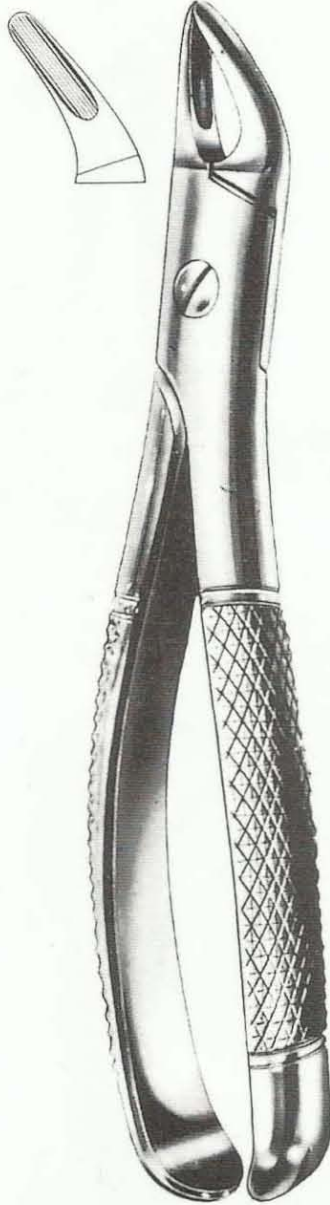

786-491
Fig:100
obere wurzeln
upper roots
racines supérieures
raices superiores



786-492
Fig:101
obere Pramolaren und Wurzein
upper Premolars and roots
Premolaires et racines supérieures
Premolares y raices superiores

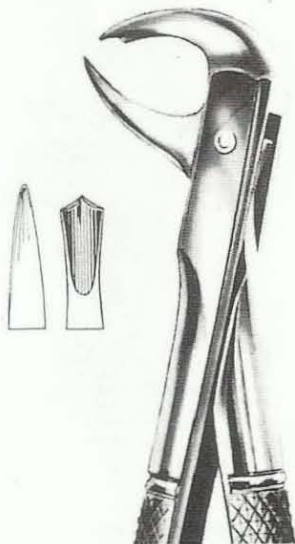

786-490
Fig:99½
untere Molaren
lower molars
molaires inférieures
molares inferiores

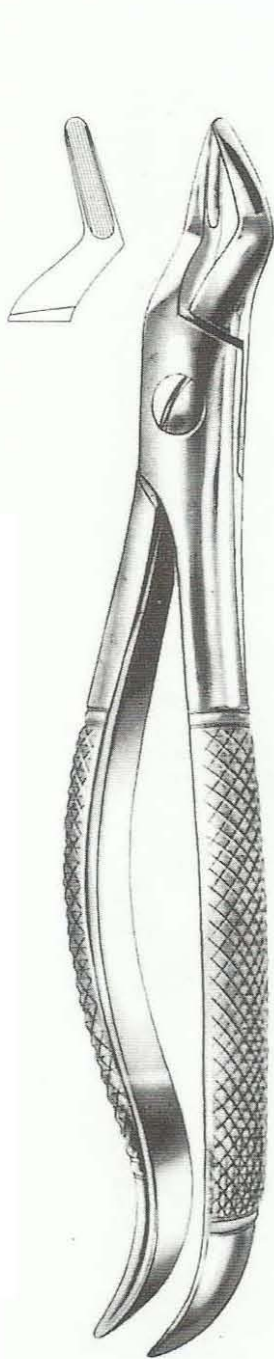

786-494
Fig:102
obere Molaren, rechts
upper molars, right
molaires supérieures droites
molares superiores derechos

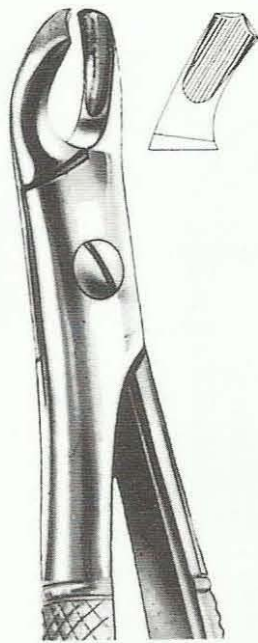

786-495
Fig:103
obere Molaren, links
upper molars, left
molaires supérieures gauches
molares superiores izquierdos



786-493
Fig:104
obere Wurzeln
upper roots
racines supérieures
raíces superiores

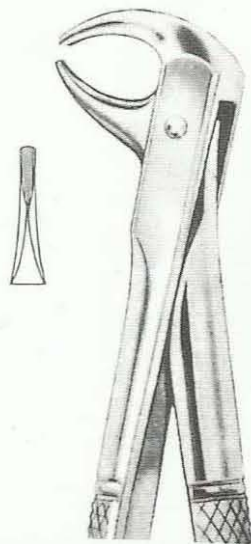

786-496
Fig:105
untere Schneidezähne
lower incisors
incisives inférieures
incisivos inferiores

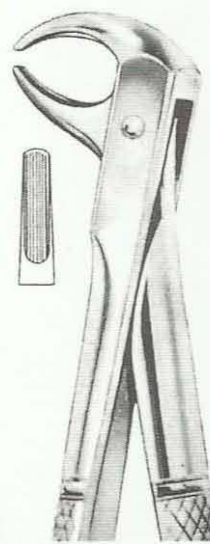

786-497
Fig:106
untere Schneidezähne
lower incisors
incisives inférieures
incisivos inferiores

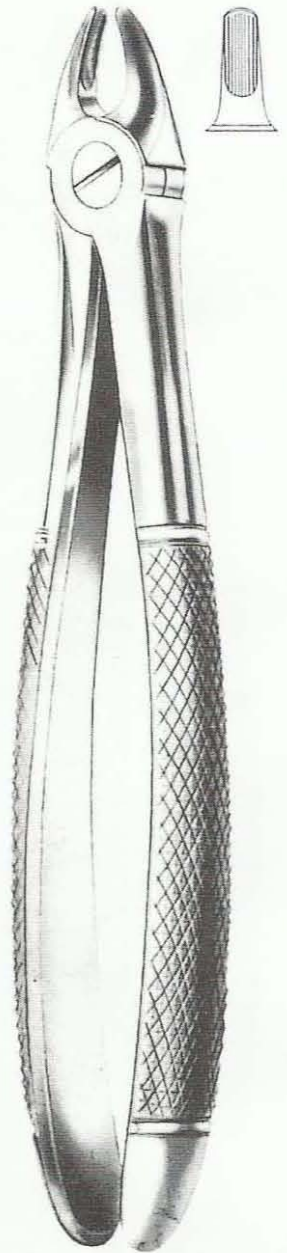

786-498
Fig:107
obere Eckzähne
upper canines
canins supérieurs
caninos superiores

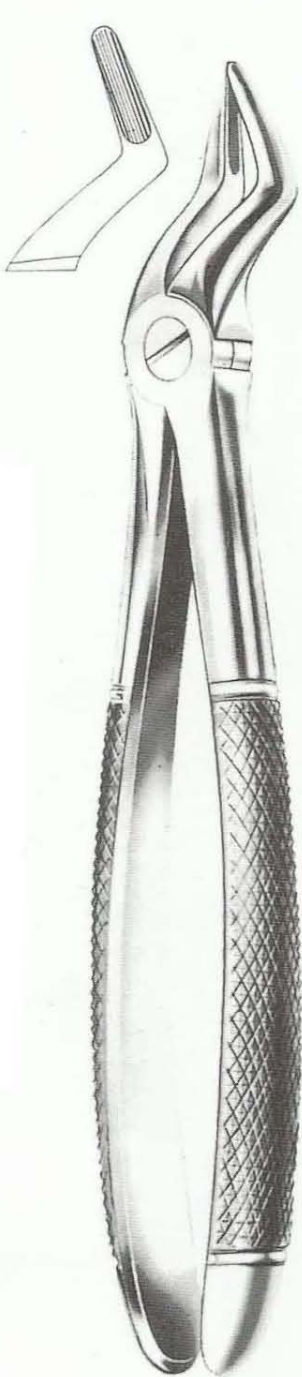

786-499
Fig:112
obere Wurzeln
upper roots
racines supérieures
raíces superiores



786-500
Fig:113
obere Wurzeln
upper roots
racines supérieures
raíces superiores

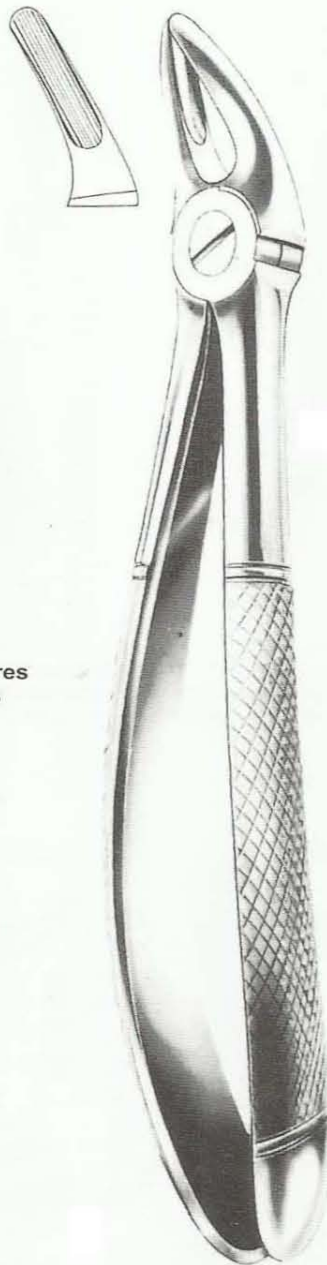

786-503
Fig:136
obere Prämolaren und Wurzeln
upper premolars and roots
prémolaires et racines supérieures
premolares y raíces superiores

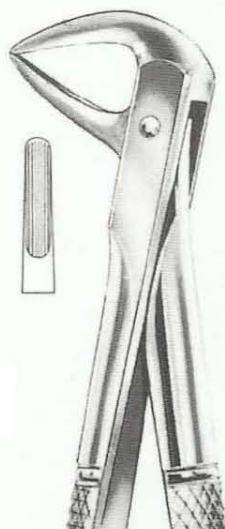

786-502
Fig:114
untere Wurzeln
lower roots
racines inférieures
raíces inferiores

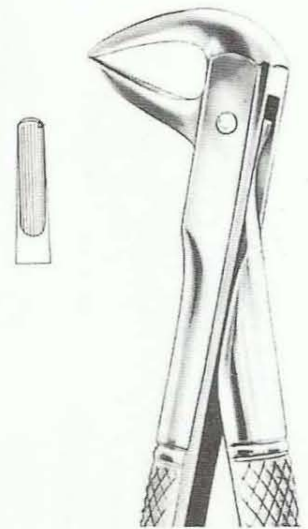
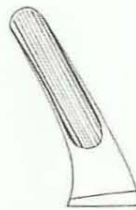

786-501
Fig:137
untere Schneidezähne und Wurzeln
lower incisors and roots
incisives et racines inférieures
incisivos y raíces inferiores

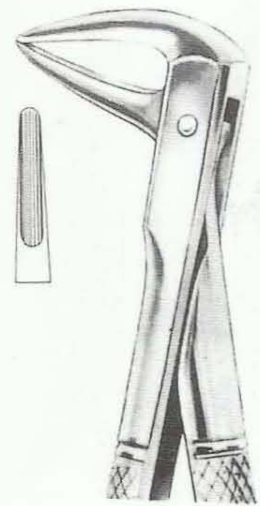

786-504
Fig:143
untere Wurzeln
lower roots
racines inférieures
raíces inferiores

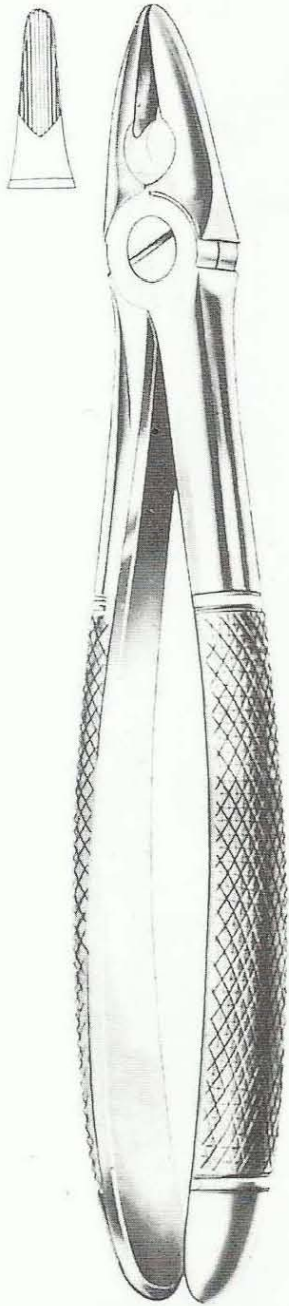

786-505
Fig:MD1
MEAD
obere Frontzähne, Wurzeln
upper anteriors, roots
incisives, canines,
racines supérieures
incisivos, caninos,
raíces superiores

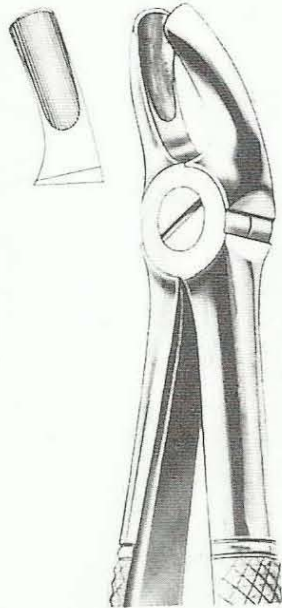

786-506
Fig:MD2
MEAD
obere Molaren
upper molars
molaires supérieures
molares superiores

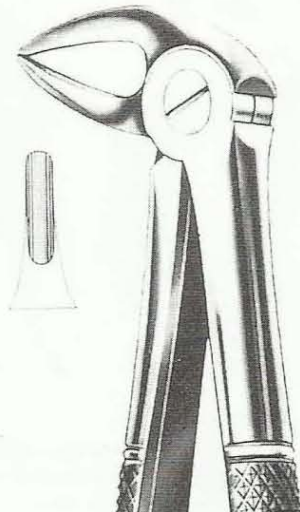

786-507
Fig:MD3
MEAD
untere Wurzeln
lower roots
racines inférieures
raíces inferiores

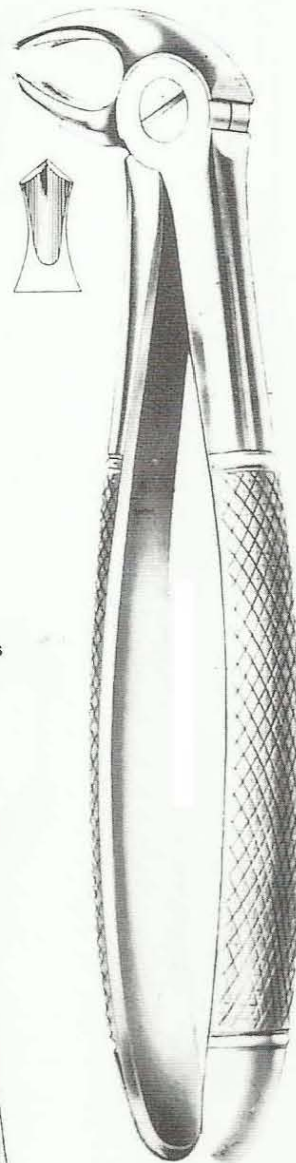

786-508
Fig:MD4
MEAD

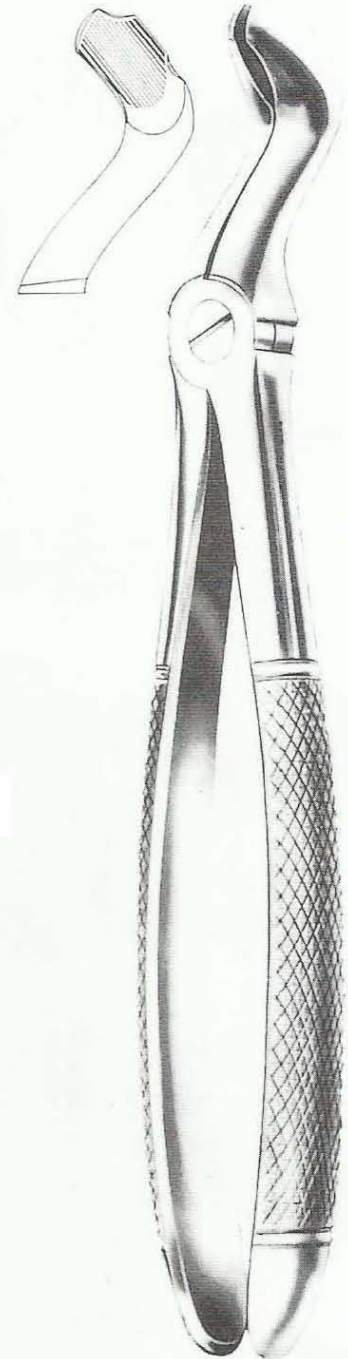

786-509
Fig:FELSCH
obere dritte Molaren
upper third molars
troisièmes molaires supérieures
terceros molares superiores

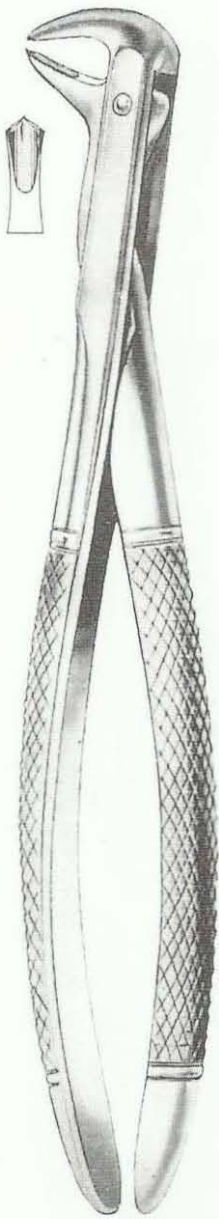

786-510
untere Molaren
und Weisheitszähne
lower molars
and wisdom
molaires et dents
de sagesse inférieures
molares y cordales
inferiores

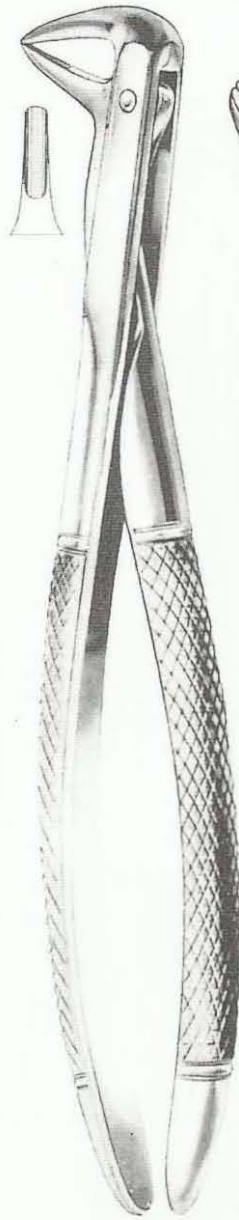

786-511
Wurzeln unterer Molaren
und Weisheitszähne
lower molar and
wisdom roots
racines des molaires et
dents de sagesse inférieures
raíces de molares y
cordales inferiores

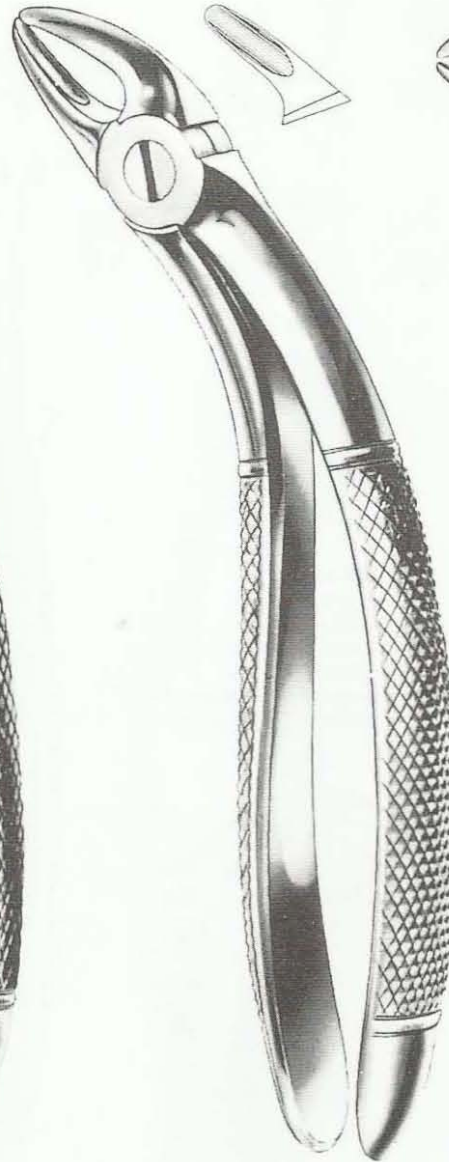

786-512
Wurzeln unterer Molaren
und Weisheitszähne
lower molar and
wisdom roots
racines des molaires et
dents de sagesse inférieures
raíces de molares y
cordales inferiores



786-513
untere Schneidezähne
lower incisors
incisives inférieures
incisivos inferiores

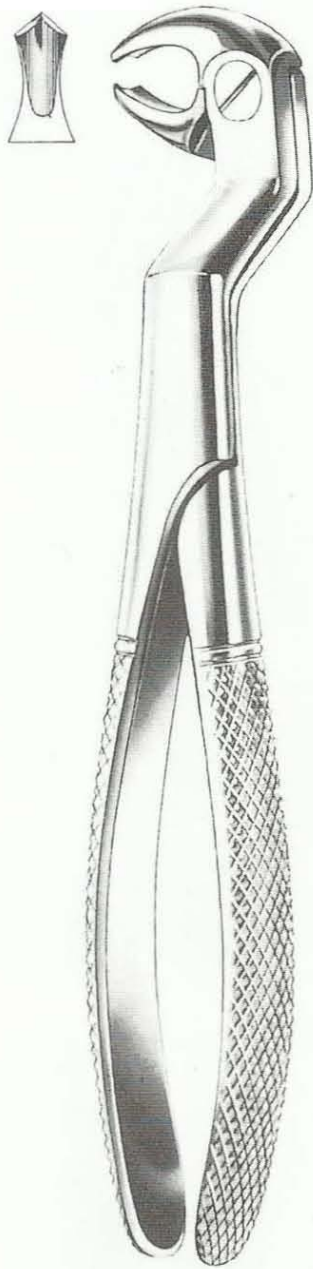

786-514
 Fig:22½L
 Molaren und Weisheits-
 zähne unten, links
 lower molars and
 wisdoms, left
 molaires et dents de sagesse
 inférieures, gauches
 molares y cordales inferiores
 lado derecho

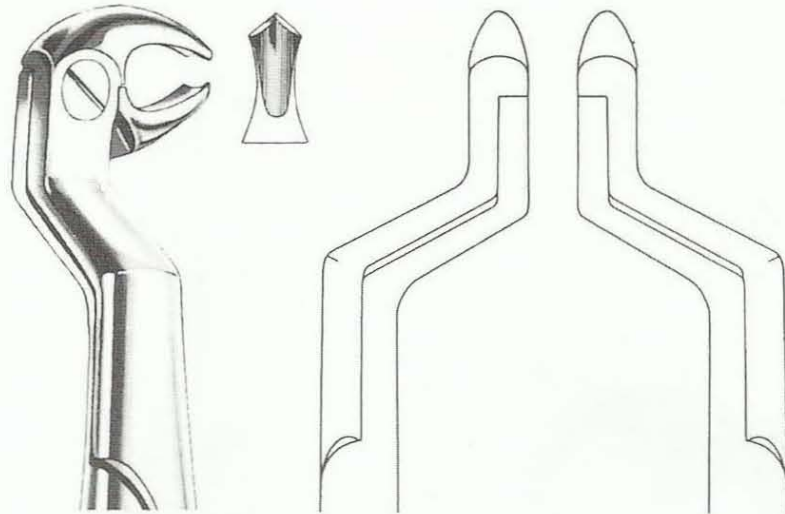

786-515
 Fig:22½R
 Molaren und Weisheits-
 zähne unten, rechts
 lower molars and
 wisdoms, right
 molaires et dents de sagesse
 inférieures, droites
 molares y cordales inferiores
 lado derecho

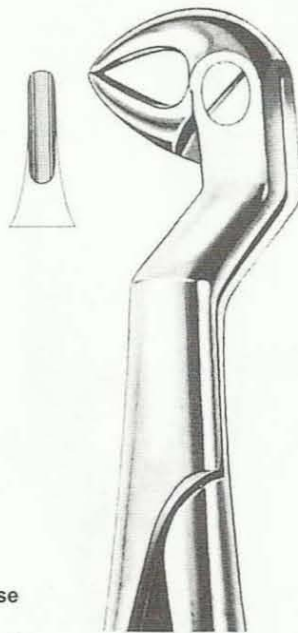

786-516
 Fig:33½L
 Wurzeln unterer molaren
 und Weisheitszähne, links
 lower molar and
 wisdom roots, left
 racines des molaires et dents
 de sagesse inférieures, gauches
 raíces de molares y cordales
 inferiores, izquierdos

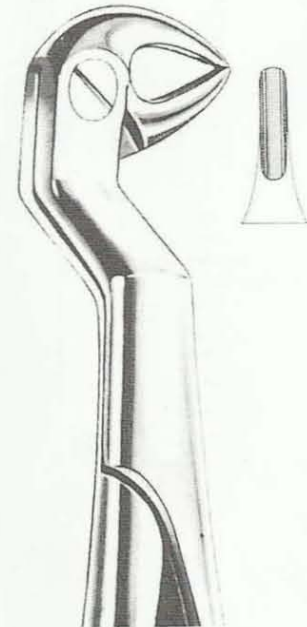

786-517
 Fig:33½R
 Wurzeln unterer molaren
 und Weisheitszähne, rechts
 lower molar and
 wisdom roots, right
 racines des molaires et dents
 de sagesse inférieures, droites
 raíces de molares y
 cordales inferiores, derechos

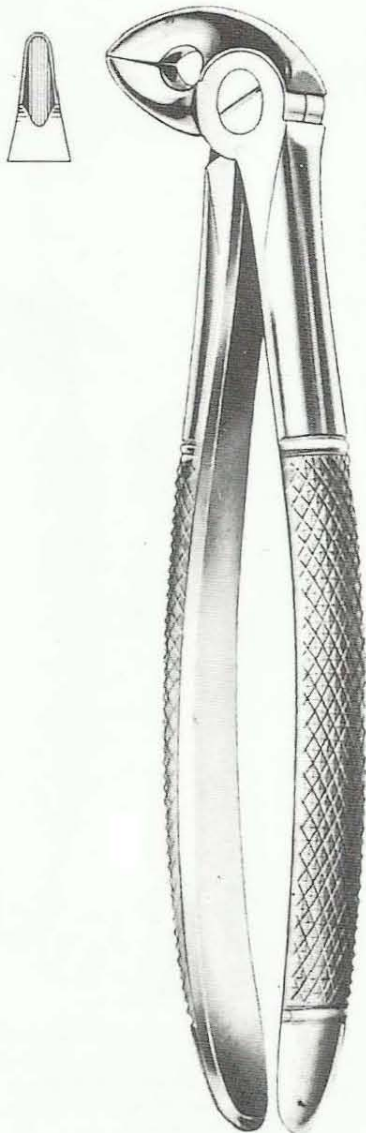

786-518/Busch
untere Wurzeln
lower roots
racines inférieures
raíces inferiores

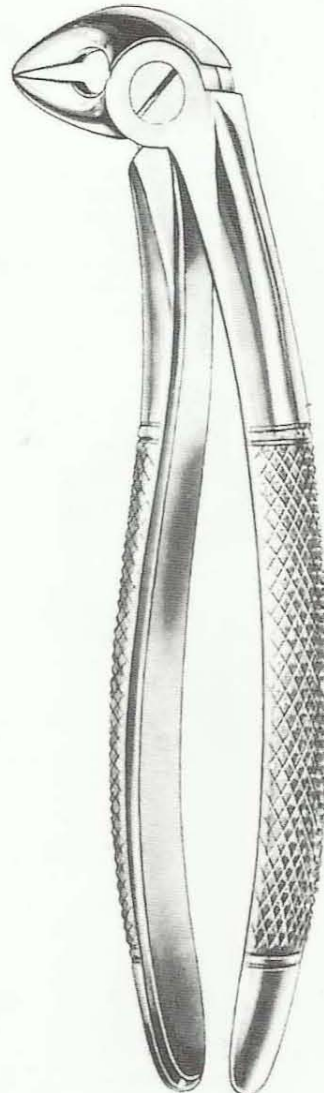

786-519/Busch
untere Wurzeln
lower roots
racines inférieures
raíces inferiores

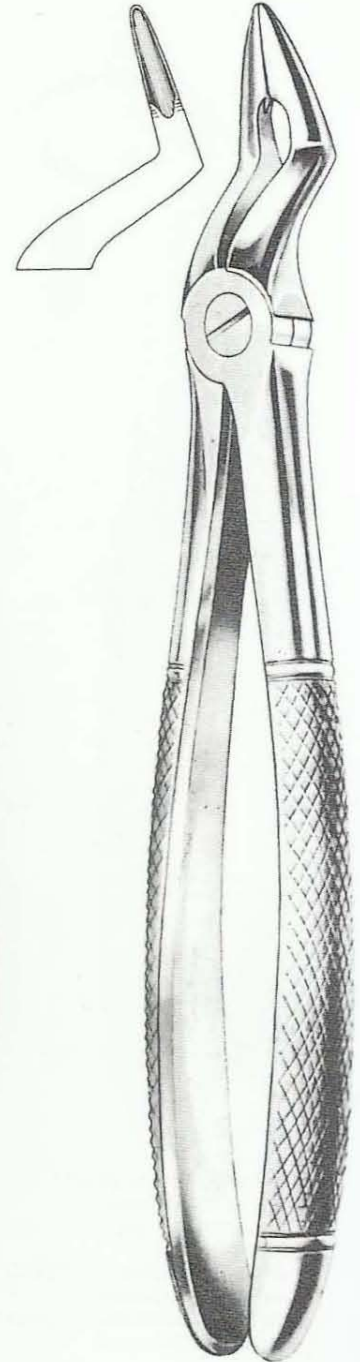

786-520/Witzel
obere Wurzeln
upper roots
racines supérieures
raíces superiores

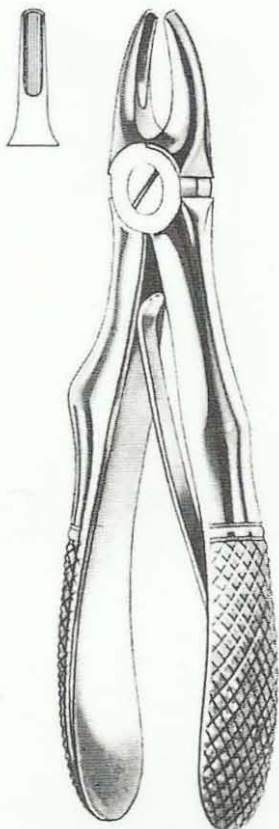

786-521/Klein
 786-522/Klein
 obere Schnidezähne
 upper incisors
 incisives supérieures
 incisivos superiores

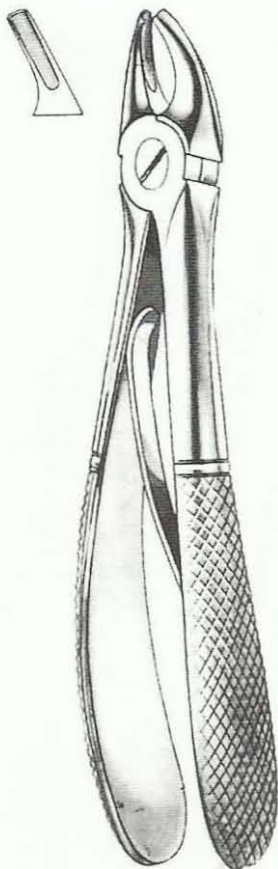

786-523/Klein
 786-524/Klein
 obere prämolaren
 upper premolars
 prémolaires supérieures
 permolares superiores

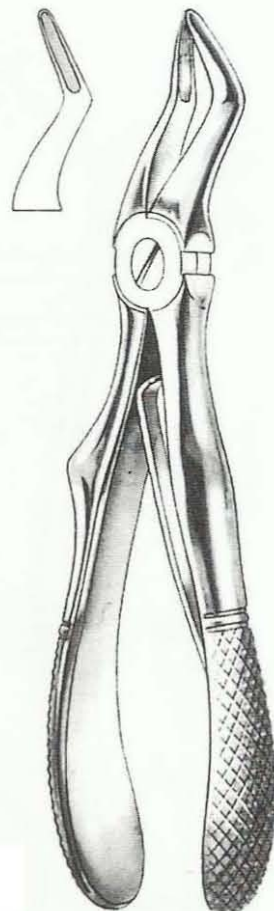

786-525/Klein
 786-526/Klein
 obere Wurzel
 upper roots
 racines supérieures
 raíces superiores

786-527
 mit Feder
 with spring
 avec ressort
 con resorte

786-528
 ohne Feder
 without spring
 sans ressort
 sin resorte

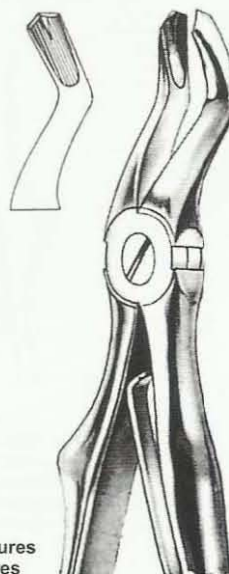

786-529/Klein
 786-530/Klein
 obere Molaren
 upper molars
 molaires supérieures
 molares superiores

Forceps and tweezers for children
 Daviers et pinces pour enfants
 Forceps y pinzas para niños

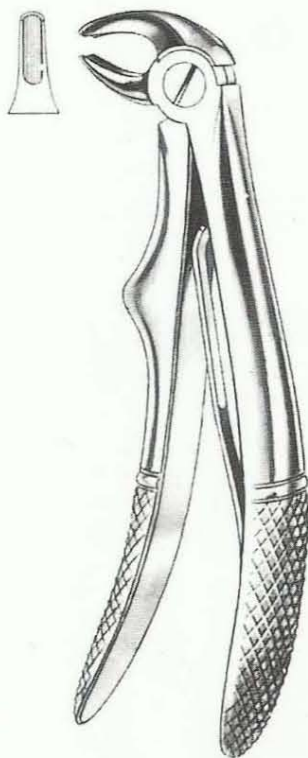

786-531/Klein
 786-532/Klein
 untere Schneidezähne
 lower incisors
 incisives inférieures
 incisivos inferiores

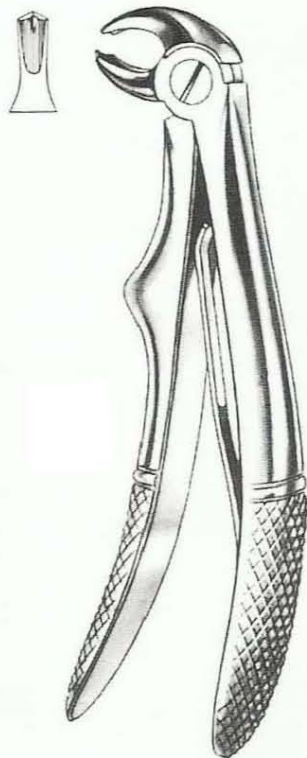

786-533/Klein
 786-534/Klein
 untere Molaren
 lower molars
 molaires inférieures
 molares inferiores

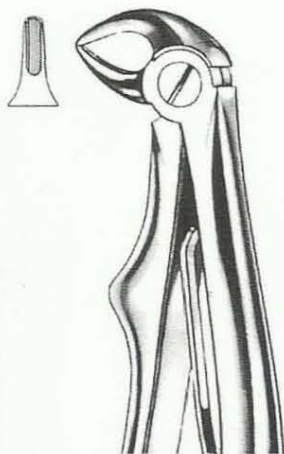

786-535
 mit Feder
 with spring
 avec ressort
 con resorte
 786-536
 ohne Feder
 without spring
 sans ressort
 sin resorte

786-537/Klein
 786-538/Klein
 untere Wurzeln
 lower roots
 racines inférieures
 raíces inferiores

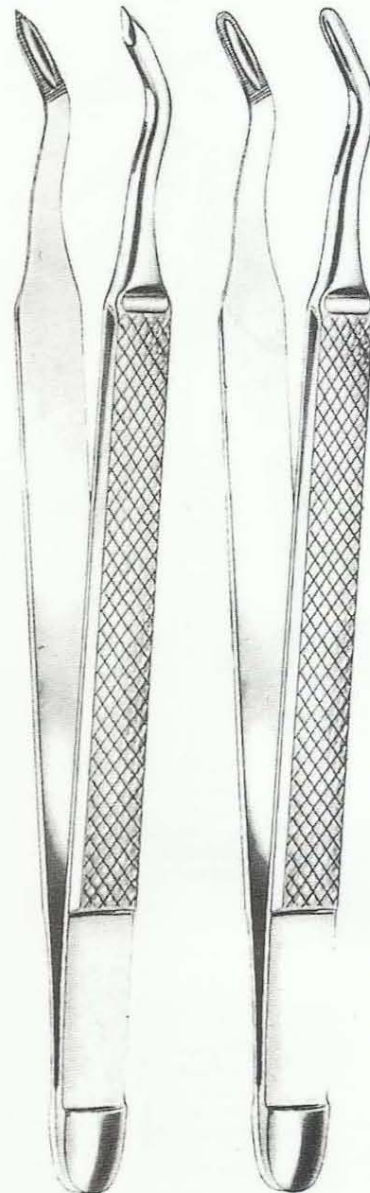

786-539
 Albrecht

786-540
 Albrecht

Milchzähne
 deciduous teeth
 dents temporaires
 dientes temporales



786-541/Witzel
untere Wurzeln
lower roots
racines inférieures
raíces inferiores

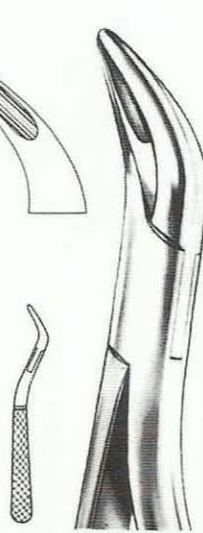

786-542/Witzel
obere Wurzeln
upper roots
racines supérieures
raíces superiores



786-545/Stieglitz
Wurzelfragmente
root fragments
fragments de racines
fragmentos de raíces



786-544/Stieglitz
Wurzelfragmente
root fragments
fragments de racines
fragmentos de raíces



786-543/Arthur
Wurzelfragmente
root fragments
fragments de racines
fragmentos de raíces

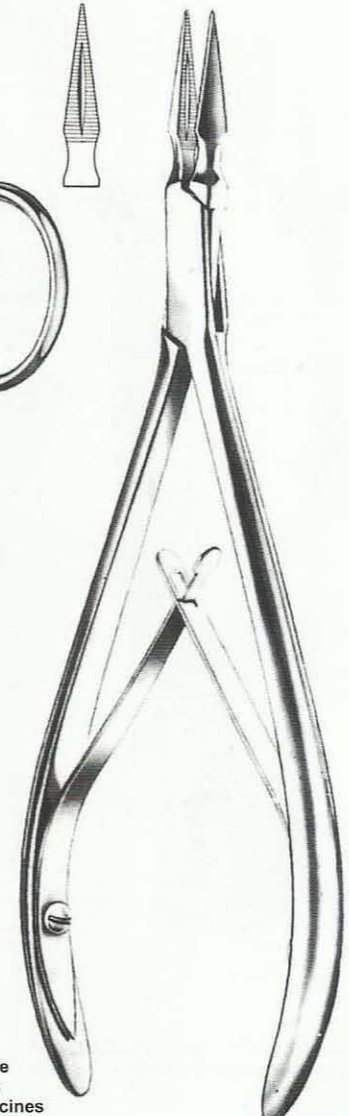

786-546/Ralk
Wurzelfragmente
root fragments
fragments de racines
fragmentos de raíces

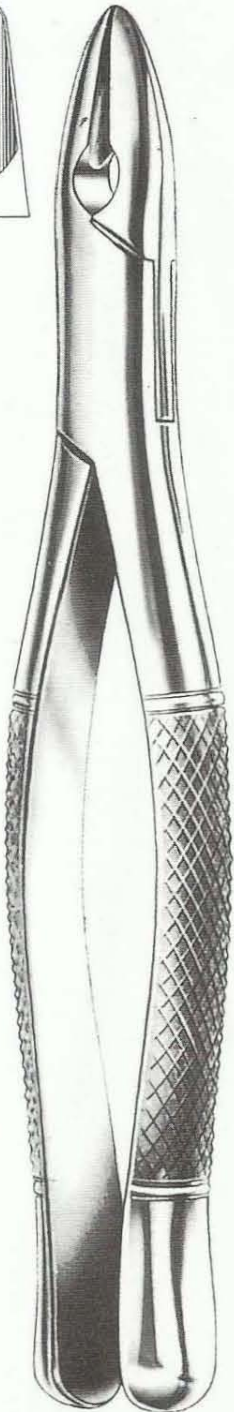

786-547
Fig:W1
Winter
obere Schneide- und Eckzähne
upper centrals and canines

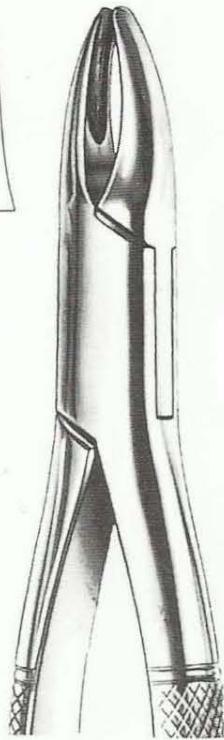
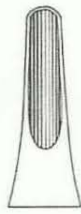

786-548
Fig:1
obere Schneidezähne und Wurzeln
upper incisors and roots
incisives et racines supérieures
incisivos y raices superiores

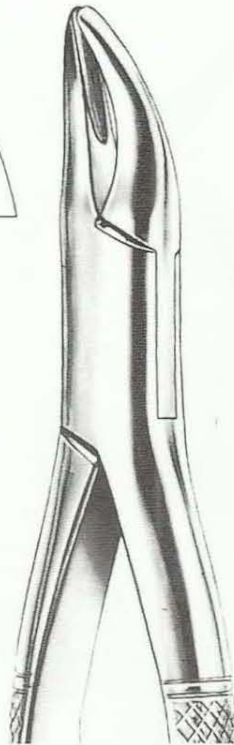
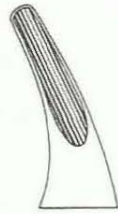

786-549
Fig:2
obere und untere Wurzeln
upper and lower roots
racines supérieures et inférieures
raices superiores y inferiores

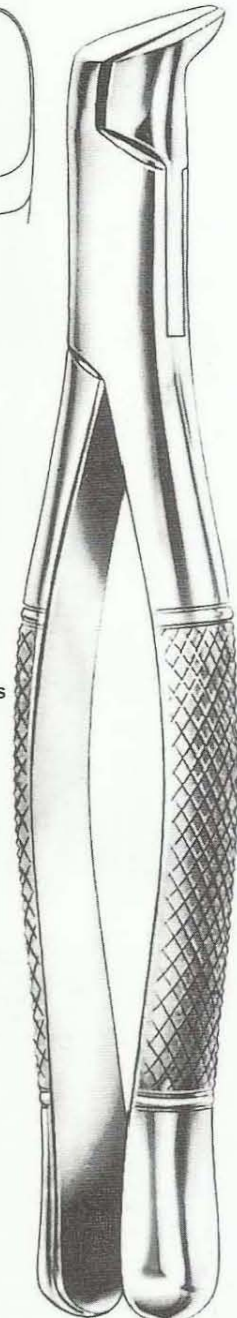
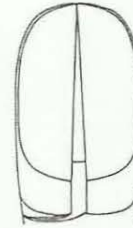

786-552
Fig:6
Spaltzange
separation forcens

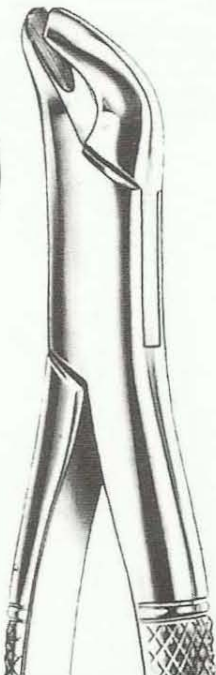

786-550
Fig:4

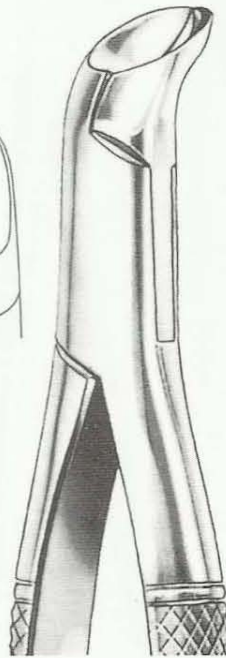
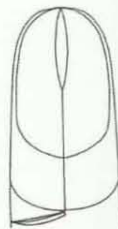

786-551
Fig:5



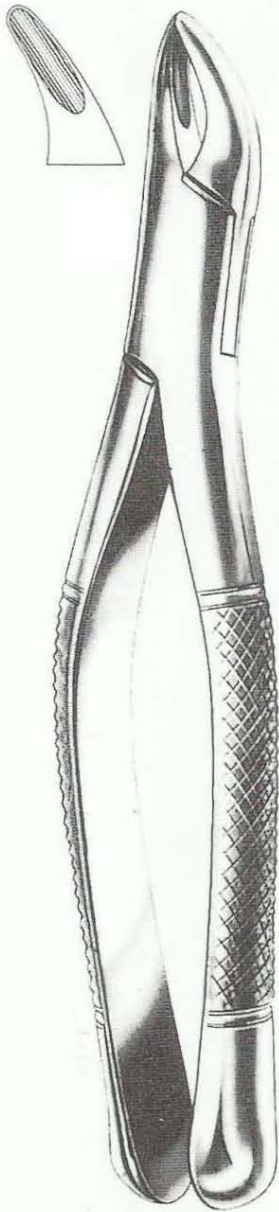

786-553
Fig:7
obere wurzein
upper roots
racines supérieures
raices superiores

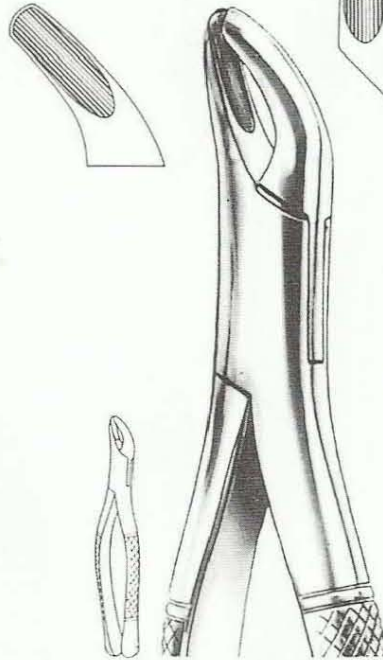

786-554
Fig:8
obere und untere dritte Molaren
upper and lower third molars
troisièmes molaires supérieures
et inférieures
terceros molares
y inferiores

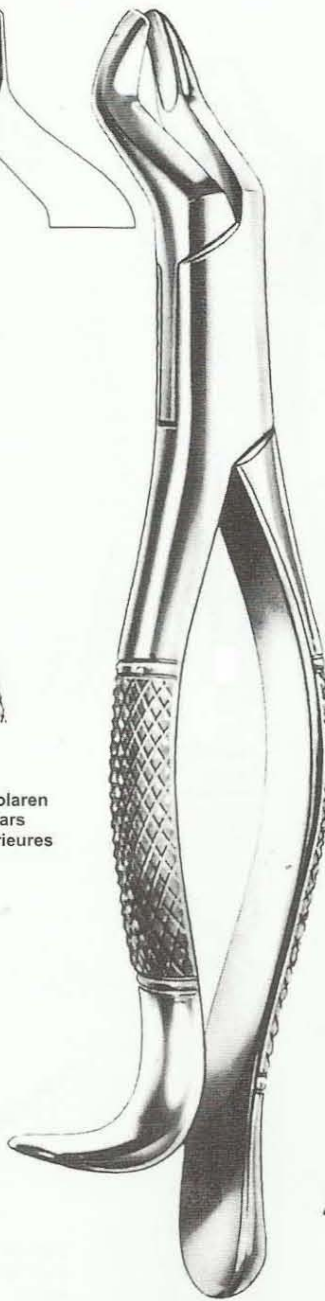

786-557
Fig:10H
obere Molaren
upper molars
molaires supérieures
molares superiores

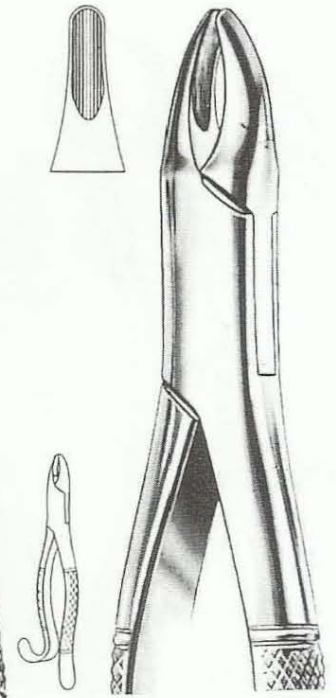

786-555
Fig:13
obere Schneidezahne
upper incisors
incisives supérieures
incisivos superiores

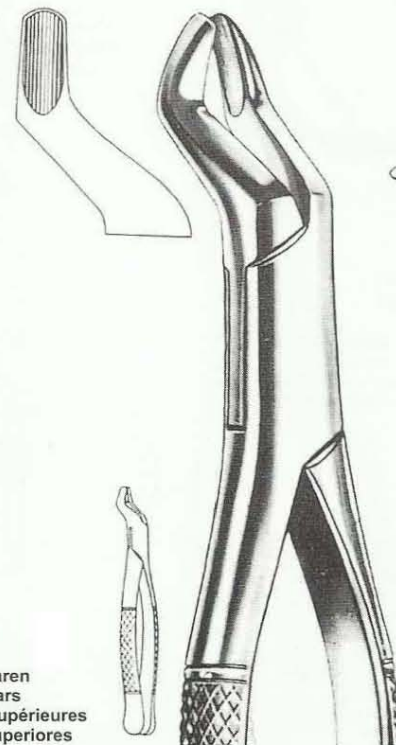

786-556
Fig:10S
obere Molaren
upper molars
molaires supérieures
molares superiores

786-558
Fig:14
untere Schneidezahne
lower incisors
incisives inférieures
incisivos inferiores

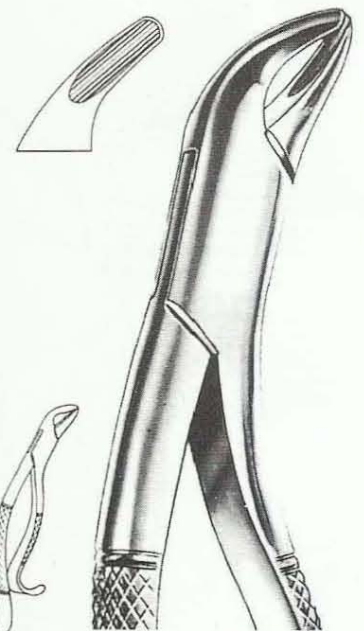

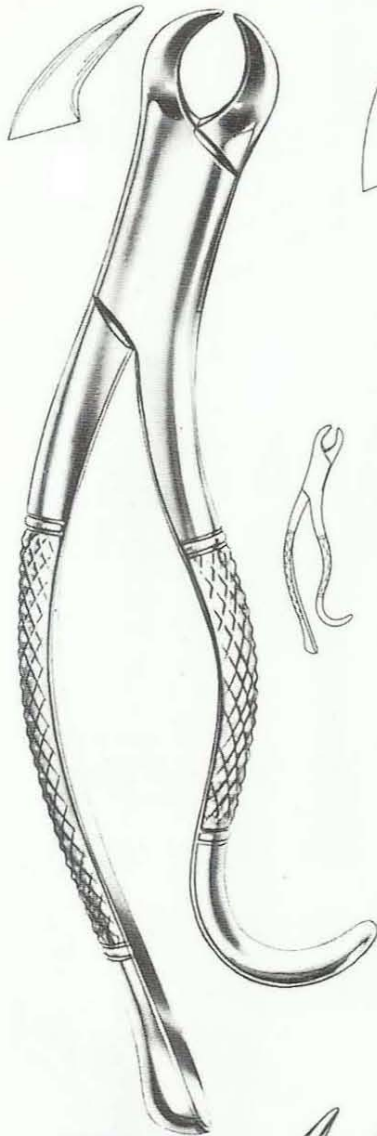

786-560
 Fig:15
 Harrisuntere
 Molaren
 lower molars
 molaires inférieures
 molares inferiores

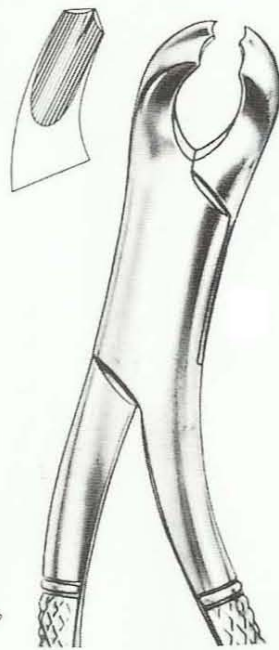

786-561
 Fig:18L
 Harris
 obere Molaren, links
 upper molars, left
 molaires supérieures gauches
 molares superiores izquierdos

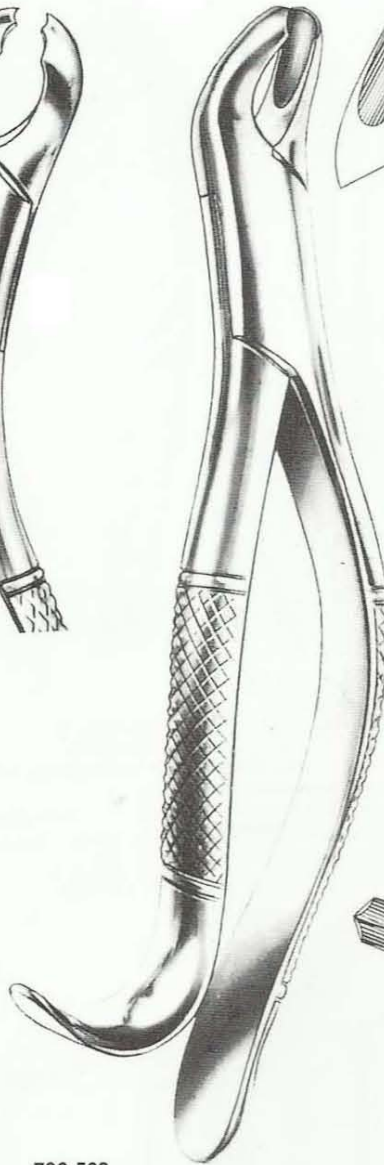

786-562
 Fig:18R
 Harris
 obere Molaren, rechts
 upper molars, right
 molaires supérieures droites
 molares superiores derechos

786-559
 Fig:16
 untere Molaren
 lower molars
 molaires inférieures
 molares inferiores

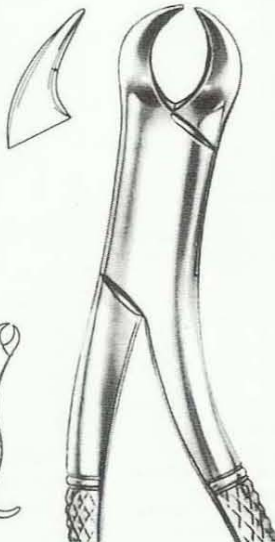

786-563
 Fig:16S
 untere Molaren,
 fur kinder
 lower molars,
 for children
 molaires inférieures,
 pour enfants
 molares inferiores,
 para niños

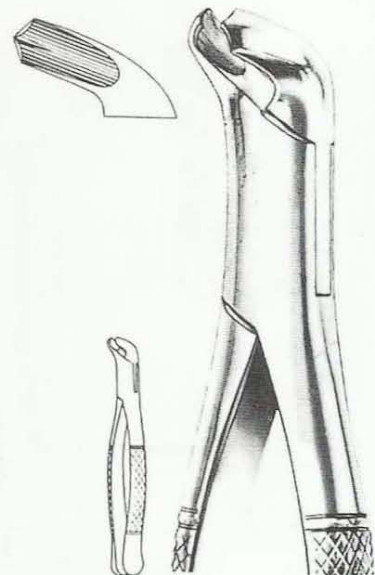

786-564
 Fig:17
 untere Molaren
 lower molars
 molaires inférieures
 molares inferiores

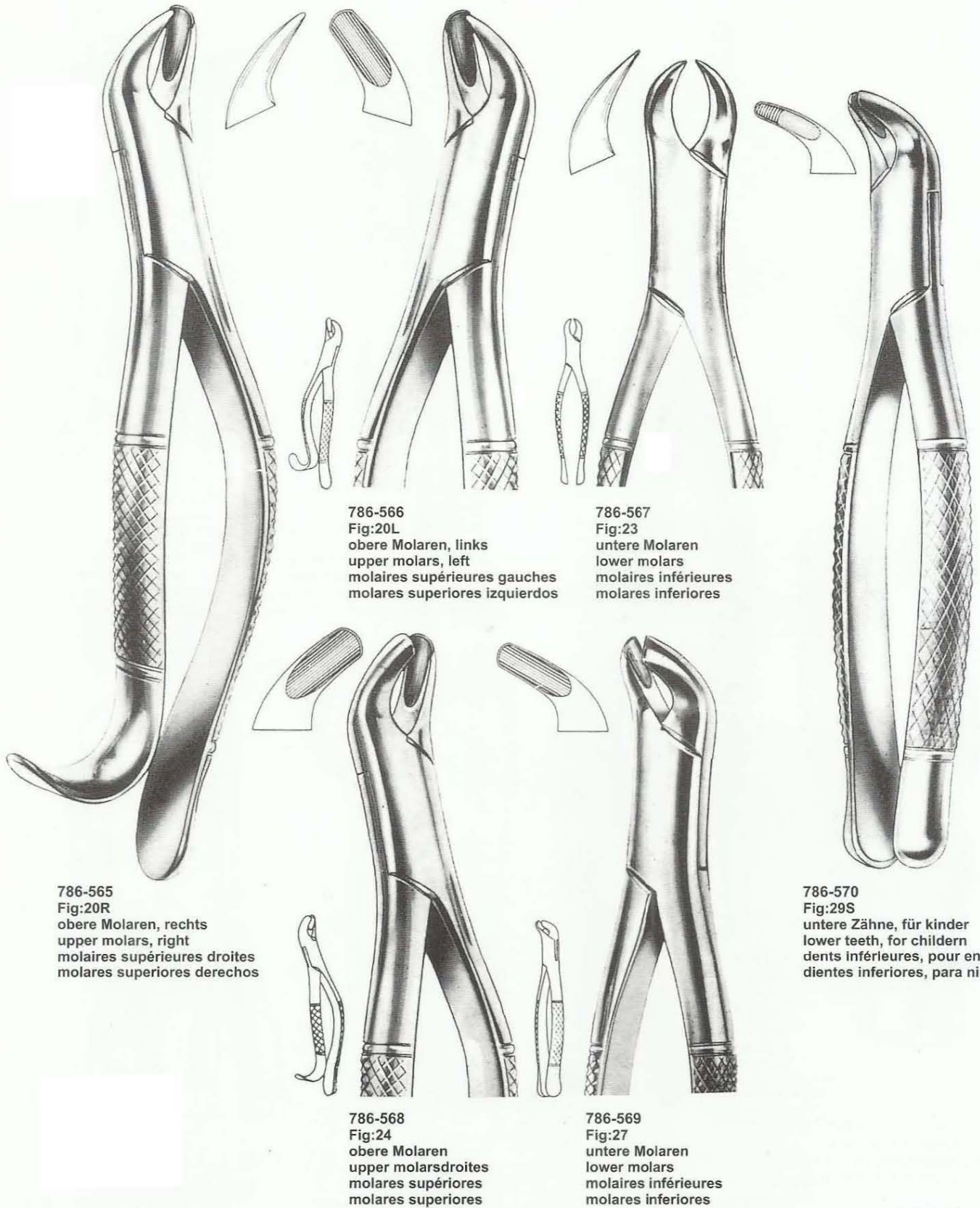

786-566
 Fig:20L
 obere Molaren, links
 upper molars, left
 molaires supérieures gauches
 molares superiores izquierdos

786-567
 Fig:23
 untere Molaren
 lower molars
 molaires inférieures
 molares inferiores

786-565
 Fig:20R
 obere Molaren, rechts
 upper molars, right
 molaires supérieures droites
 molares superiores derechos

786-570
 Fig:29S
 untere Zähne, für kinder
 lower teeth, for children
 dents inférieures, pour enfants
 dientes inferiores, para niños

786-568
 Fig:24
 obere Molaren
 upper molars, right
 molaires supérieures
 molares superiores

786-569
 Fig:27
 untere Molaren
 lower molars
 molaires inférieures
 molares inferiores

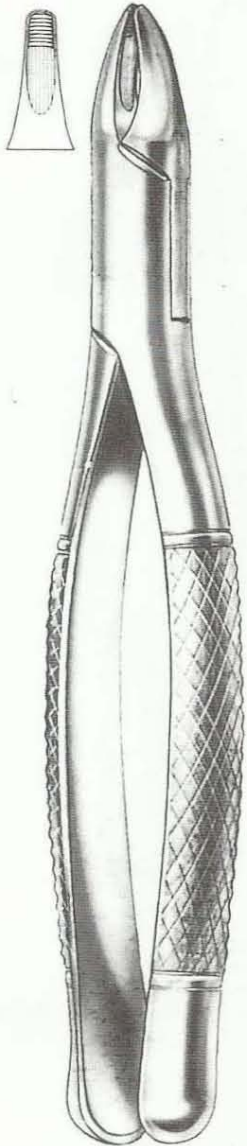

786-571
Fig:30S
obere Zähne, für kinder
upper teeth, for children
dents inférieures, pour enfants
dientes inferiores, para niños

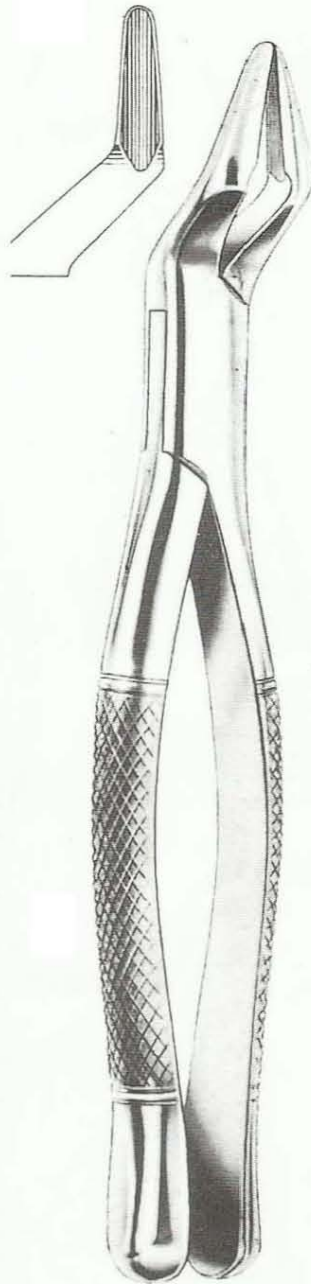

786-572
Fig:32
parmlly
obere Pramolaren und Molaren
upper premolars and molars
prémolaires, et molaires supérieures
premolares y molares superiores

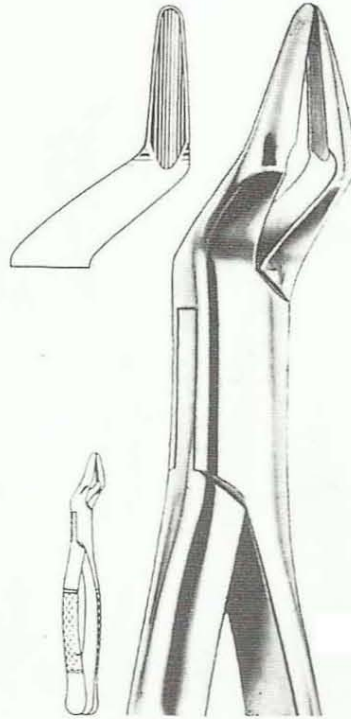

786-573
Fig:32A
parmlly
obere Pramolaren und wurzein
upper premolars and roots
prémolaires, et racines supérieures
premolares y raices superiores

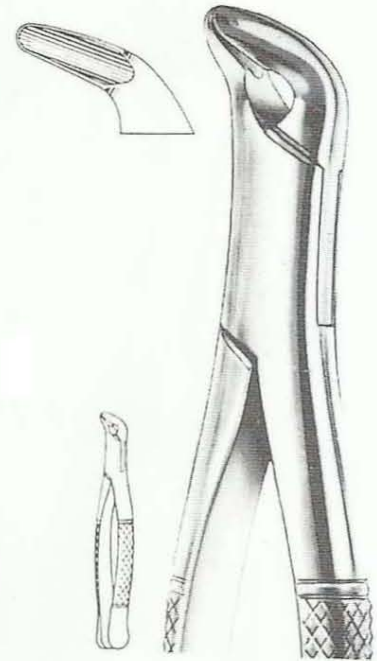

786-574
Fig:34
untere Zähne und wurzein
lower anteriors and roots
dents et racines inférieures
dientes y raices inferiores

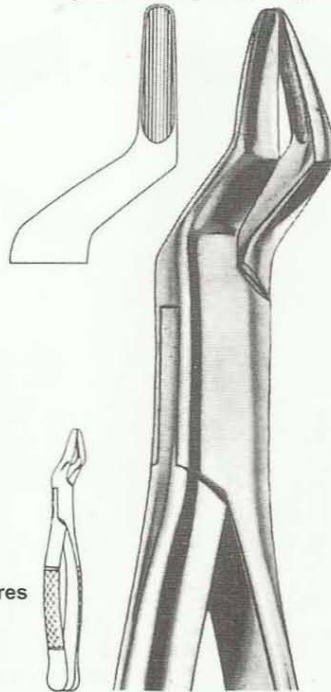

786-575
Fig:35
obere wurzein
upper roots
racines supérieures
raices superiores

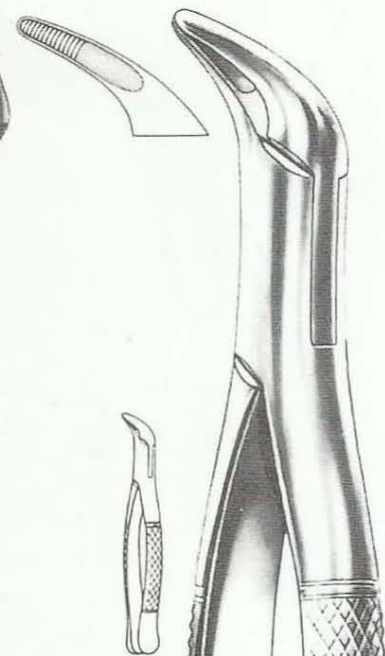

786-576
Fig:36
untere Zähne und wurzein
lower anteriors and roots
dents et racines inférieures
dientes y raices inferiores

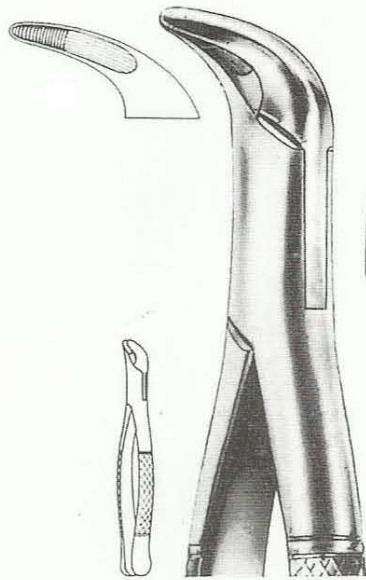

786-577
Fig:37
untere Zähne und Wurzeln
loweranterior and roots
dents et racines inférieures
dientes y raíces inferiores

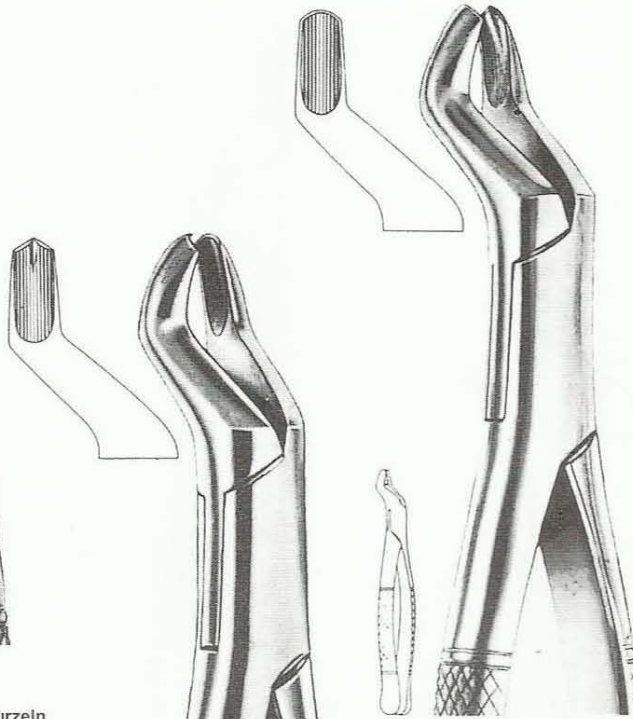

786-579
Fig:53L
obere Molaren, links
upper molars, left
molaires Supérieures gauches
molares superiores izquierdos

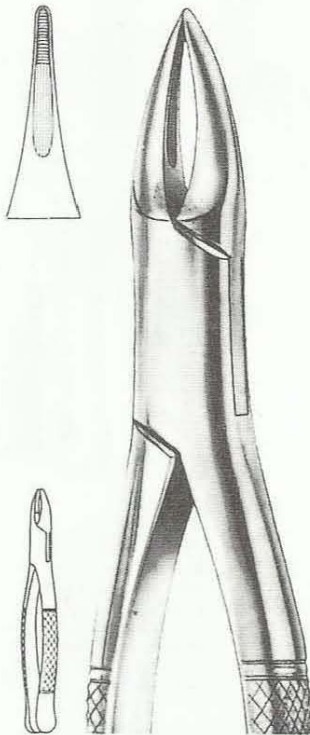

786-578
Fig:38
obere Zähne und Wurzeln
upper anterior and roots
dents et racines supérieures
dientes y raíces superiores

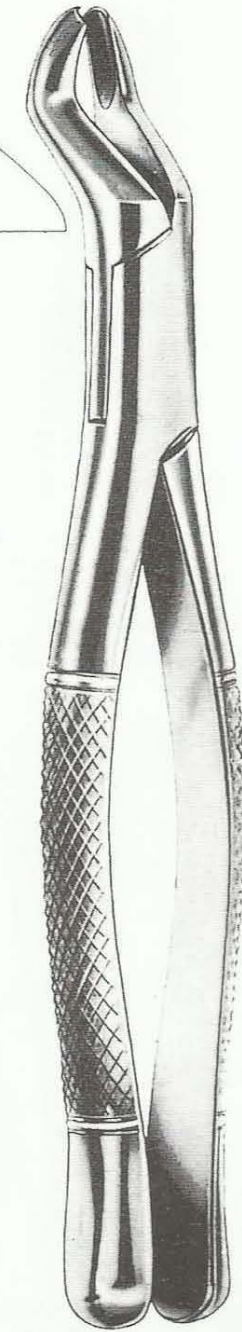

786-580
Fig:53R
obere Molaren, rechts
upper molars, right
molaires supérieures droites
molares superiores derechos

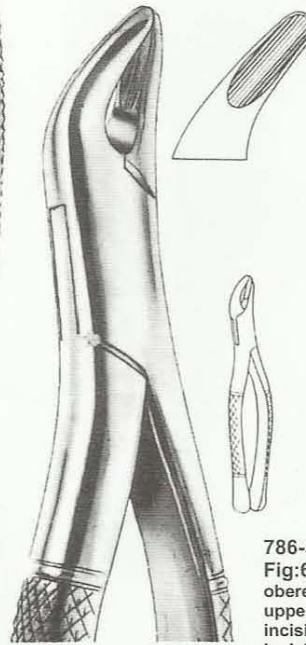

786-581
Fig:62
Schneidezähne, Pramolaren, Milchzähne
incisors, premolars, deciduous teeth
incisivos, prémolares, dientes de lait
incisivos, premolares, dientes de leche

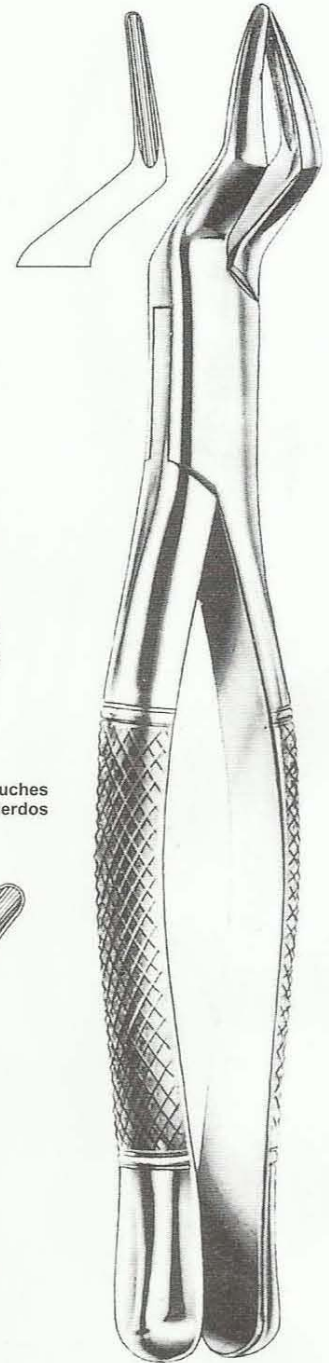

786-582
Fig:65
obere Schneidezähne und Wurzeln
upper incisors and roots
incisives et racines supérieures
incisivos y raíces superiores

Extracting Forceps
 Daviers
 Forceps de Extracción

American Pattern
 Forme américaine
 Forma americana

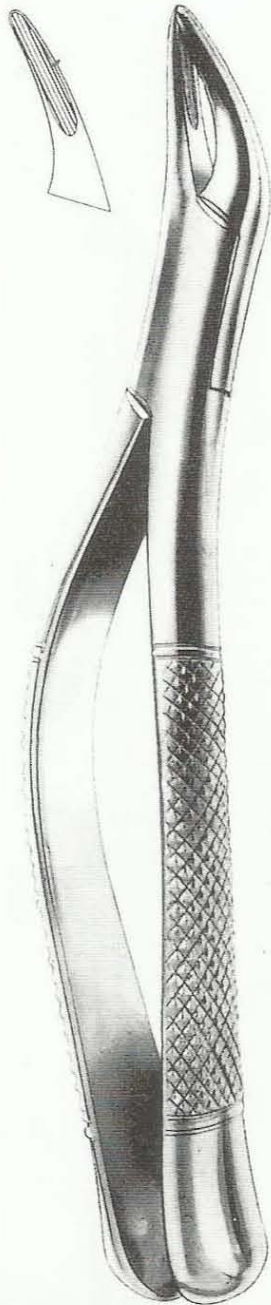

786-583
 Fig:69
 Tomes
 obere und untere Wurzeln
 upper and lower roots
 racines supérieures et inférieures
 raíces superiores y inferiores

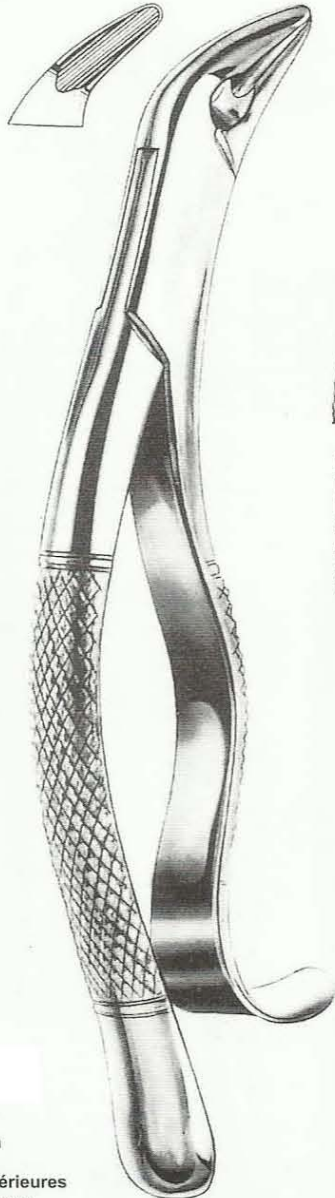

786-584
 Fig:85
 Thomas
 untere Eckzähne, Pramolaren, Molaren
 lower canines, premolars and molars
 canines, prémolaires, molaires infér
 coninos, premolares, molares infer.

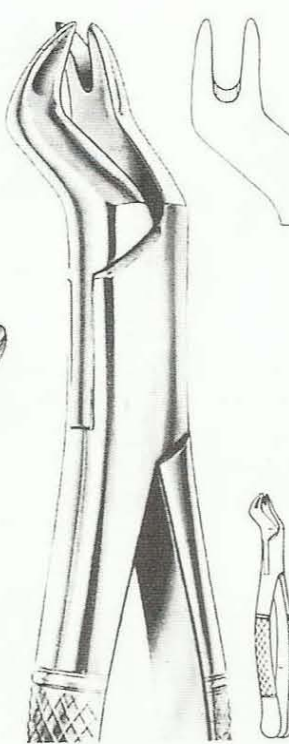

786-585
 Fig:88R
 Nervius
 obere Molaren, rechtes
 upper molars, right
 molaires supérieures droites
 molares superiores derechos

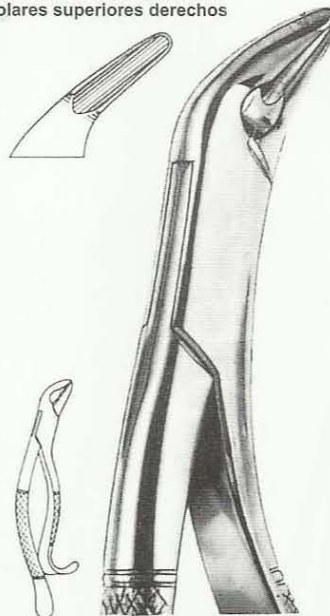

786-587
 Fig:88L
 Nervius
 obere Molaren, links
 upper molars, left
 molaires Supérieures gauches
 molares superiores izquierdos

786-586
 Fig:85A
 Thomas
 untere Eckzähne, Pramolaren, Molaren
 lower canines, premolars and molars
 canines, prémolaires, molaires infér
 coninos, premolares, molares infer.

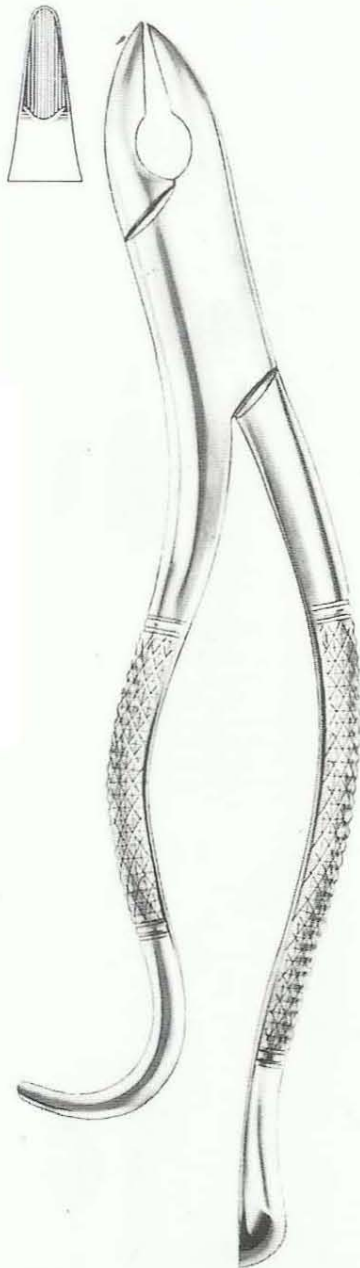

786-588
Fig:99A
Kells
Obere Schneide-u.Eckzähne,Prämolaren
upper incisors, canines, premolars
incisives, canines, prémolaires supér.
Incisivos, caninos, premolares super.

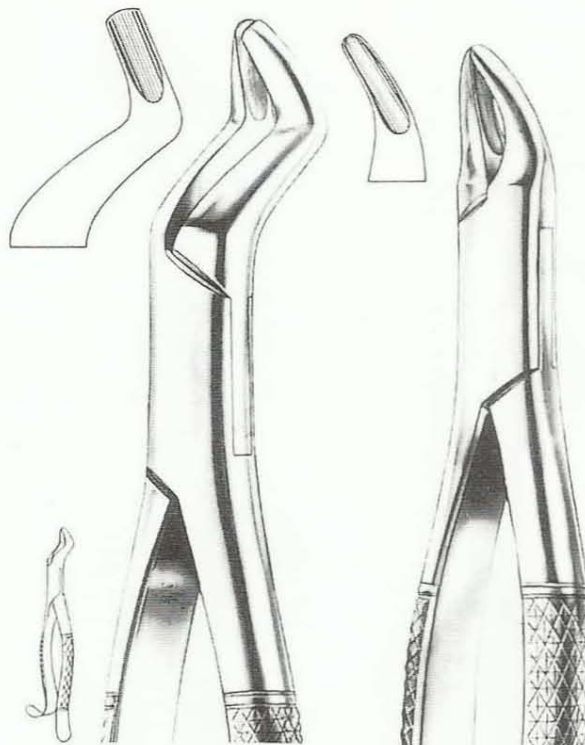

786-589
Fig:104
Obere dritte Molren
upper third molars
troisièmes molaires supérieures
terceros molares superiores

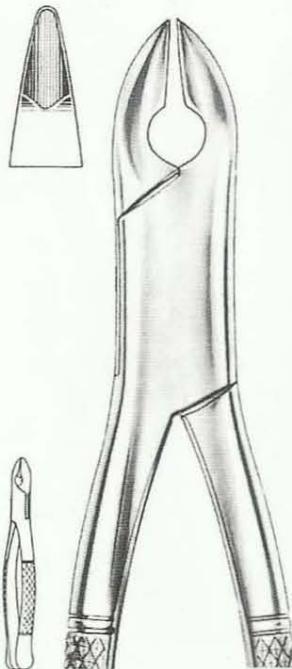

786-590
Fig:99C
Kells
Obere Schneide-u.Eckzähne,Prämolaren
upper incisors, canines, premolars
incisives, canines prémolaires supér
Incisivos caninos, premolares super.

786-591
Fig:101
Hull
Milchzähne
deciduous teeth
dents temporaires
dientes temporales



786-592
Fig:103
unter Schneidezähne,Prämolaren
lower incisors, premolars
incisives prémolaires, racines infér.
Incisivos premolares, raíces infer

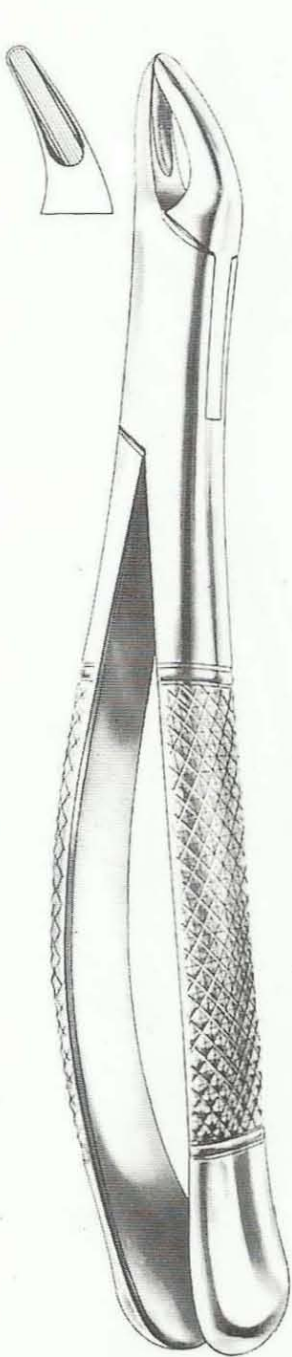

786-593
Fig:150
Cryer
obere Schneidezähne. Prämolaren
und Wurzeln
upper incisors, premolars, roots
incisives,premolaires, racines supér.
Incisivos, premolares, raices super.

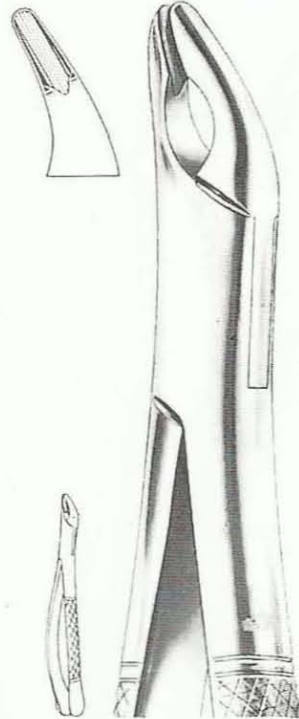

786-594
Fig:150A
Cryer
obere Schneidezähne. Prämolaren
und Wurzeln
upper incisors, premolars, roots
incisives,premolaires, racines supér.
Incisivos, premolares, raices super.

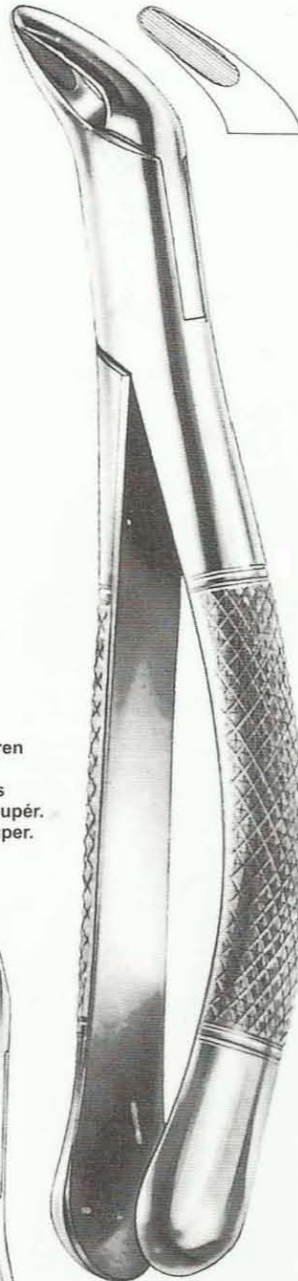

786-596
Fig:151
Cryer
untere Schneidezähne. Prämolaren
und Wurzeln
lower incisors, premolars, roots
incisives,premolaires, racines infér.
Incisivos, premolares, raices infer.

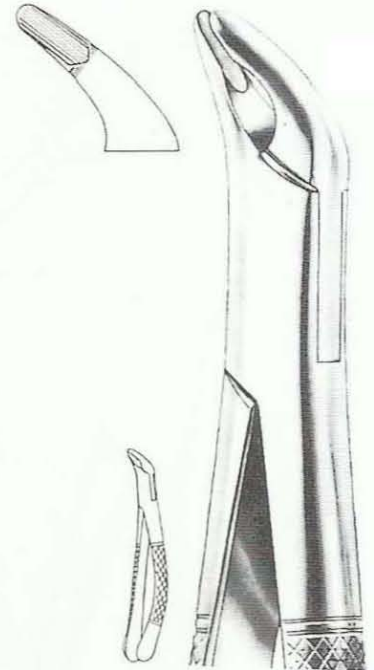

786-597
Fig:151A
Cryer
untere Schneidezähne. Prämolaren
und Wurzeln
lower incisors, premolars, roots
incisives,premolaires, racines infér.
Incisivos, premolares, raices infer.

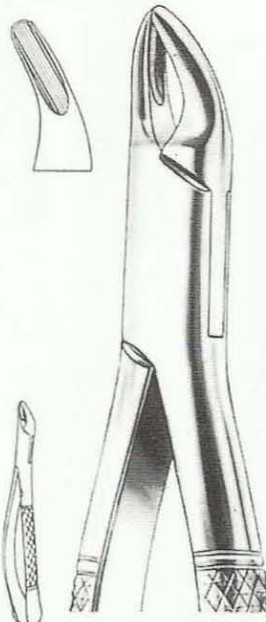

786-595
Fig:150S
Cryer
obere Zähne, für kinder
upper teeth, for children
dents supérieures, pour enfants
dientes superiores, para niños

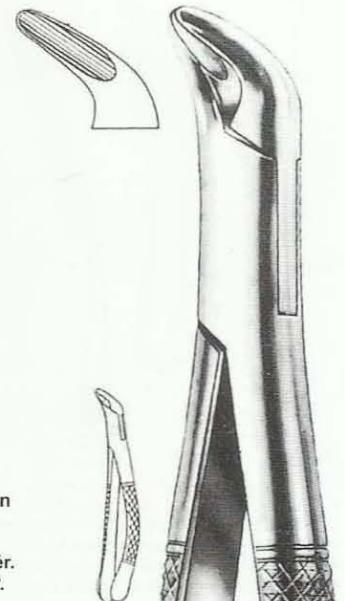

786-598
Fig:151S
Cryer
untere Zähne, für kinder
lower teeth, for children
dents inférieures, pour enfants
dientes inferiores, para niños

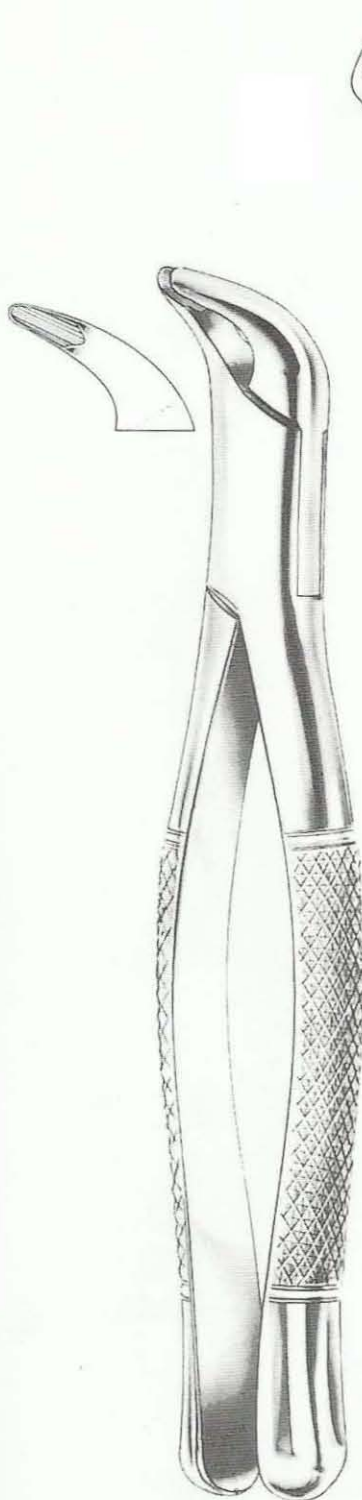

786-599
Fig:203
untere Schneidezähne und wurzeln
lower incisors and roots
incisives et racines inférieures
incisivos y raíces inferiores

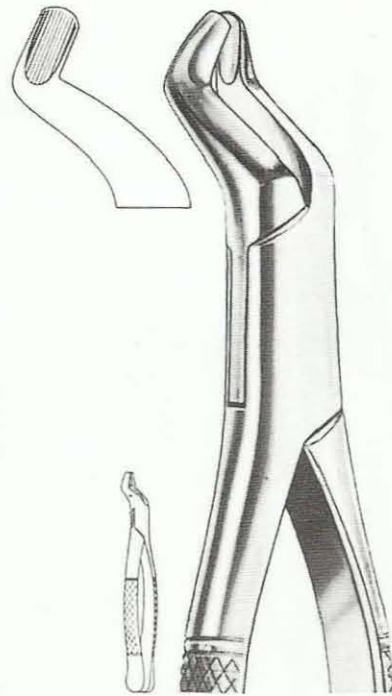

786-600
Fig:210S
obere dritte Molaren
upper third molars
troisièmes molaires
supérieures
terceros molares
superiores

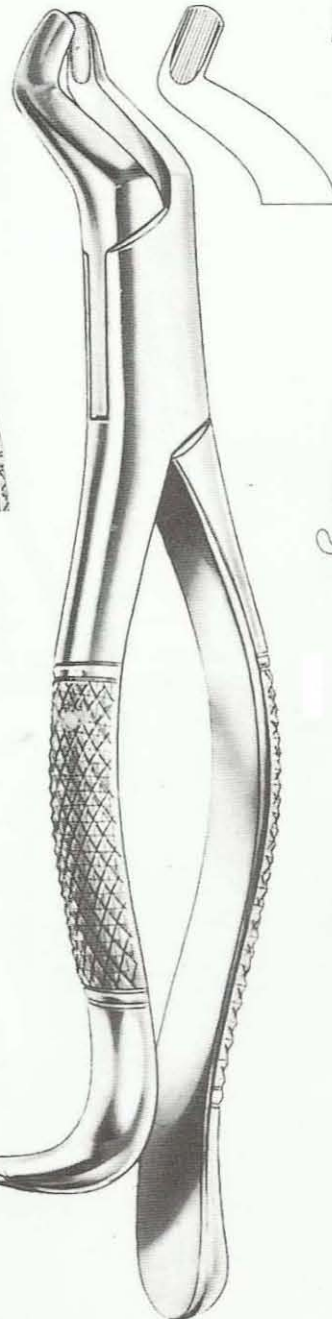

786-602
Fig:210H
obere dritte Molaren
upper third molars
troisièmes molaires supérieures
terceros molares superiores

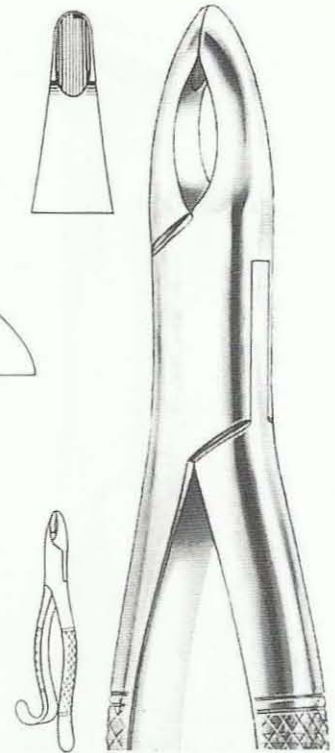

786-603
Fig:213
obere Schneide- und Eckzähne
upper centrals and canines
incisives et canines supérieures
incisivos y caninos superiores

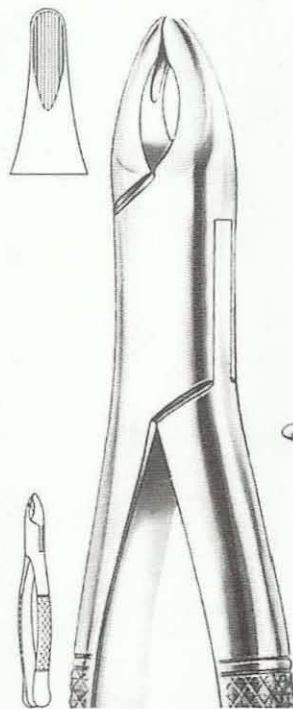

786-601
Fig:201
obere Schneide- u Eckzähne, prämolaren
upper incisors, canines, premolars
incisives, canines prémolaires supér
incisivos caninos, premolares super.

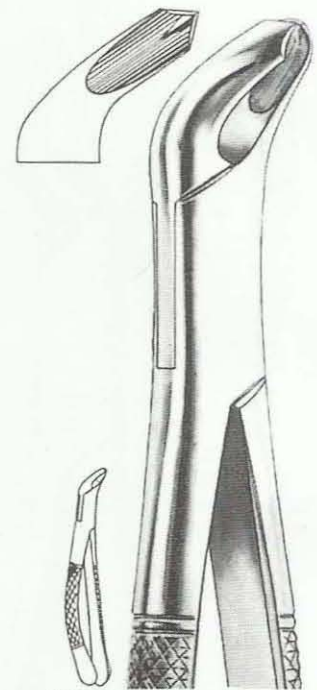

786-604
Fig:217
untere Molaren
lower molars
molaires inférieures
molares inferiores

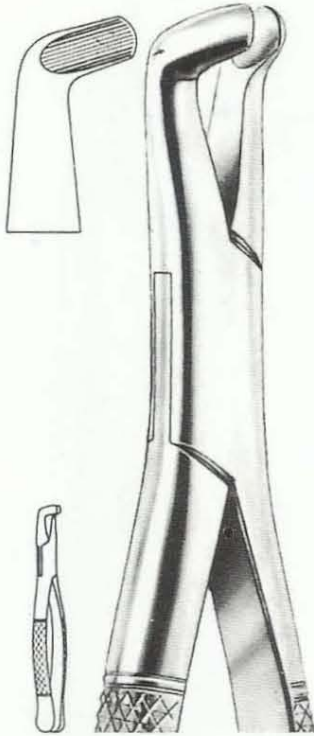

786-605
Fig:222
untere dritte Molren
lower third molars
troisièmes molaires inférieures
terceros molares inferiores

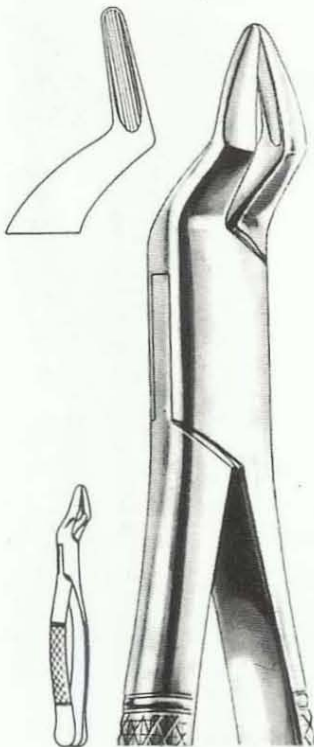

786-606
Fig:286
Obere Schneidezähne und wurzein
upper incisors, and roots
Incisives, et racines supérieures
Incisivos, y raices superiores



786-607
Fig:287
Swing
untere Molaren
lower molars
molaires inférieures
molares inferiores



786-608
Fig:288
untere Eckzähne und Prämolaren
lower canines and premolars
canines, prémolaires, inférieures.
Caninos, premolares, inferiores

Extracting Forceps
Daviers
Forceps de Extracción

American Pattern
Forme américaine
Forma americana

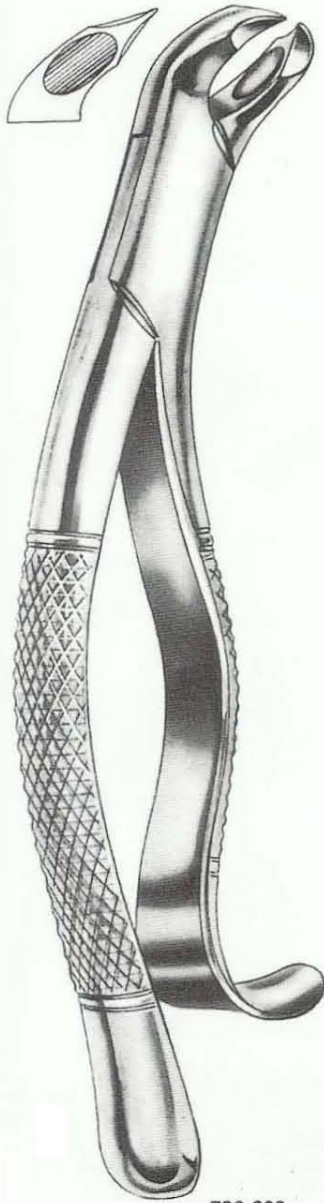

786-609
Woodward
untere Molaren
lower molars
molaires inférieures
molares inferiores

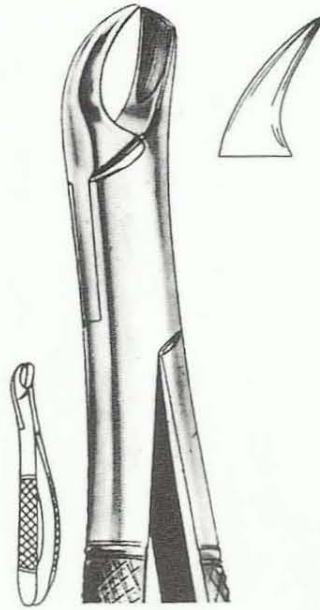

786-610
Fig:89
obere Molaren, rechts
upper molars, right
molaires Supérieures droites
molares superiores derechos

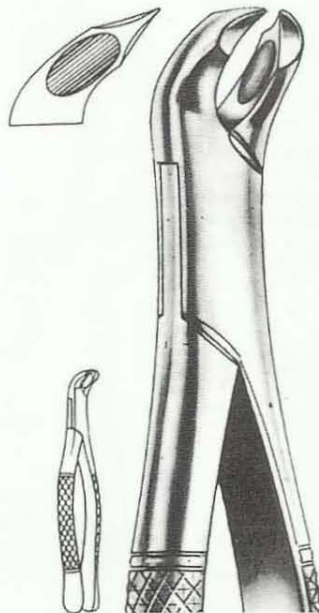

786-611
Woodward
untere Molaren
lower molars
molaires inférieures
molares inferiores

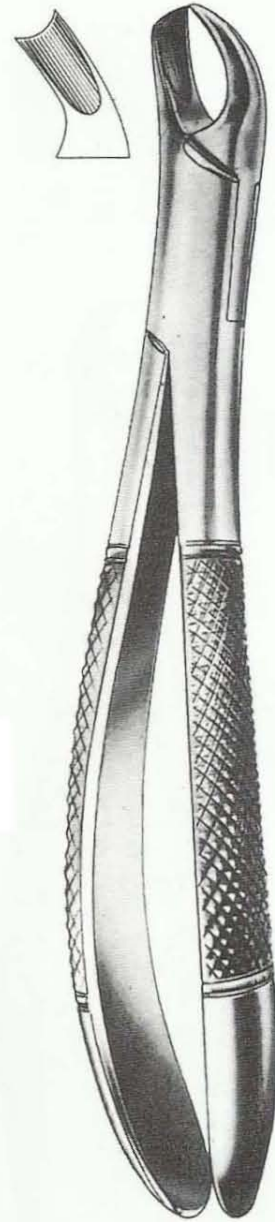

786-612
Fig:90
obere Molaren, links
upper molars, left
molaires Supérieures gauches
molares superiores izquierdos



786-613
Fig:23S
untere Molaren
lower molars
molaires inférieures
molares inferiores

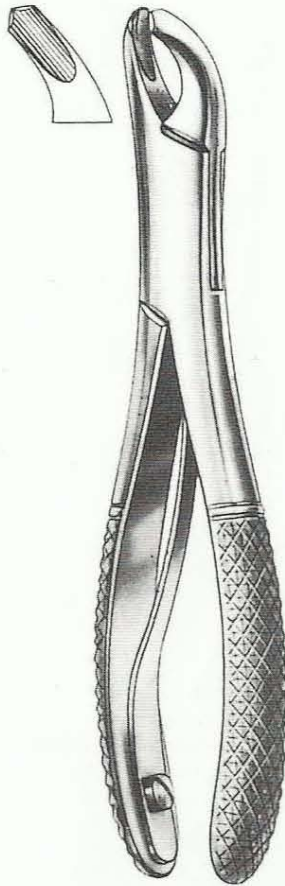

786-614
Fig:17SK
untere Molaren
lower molars
molaires inférieures
molares inferiores

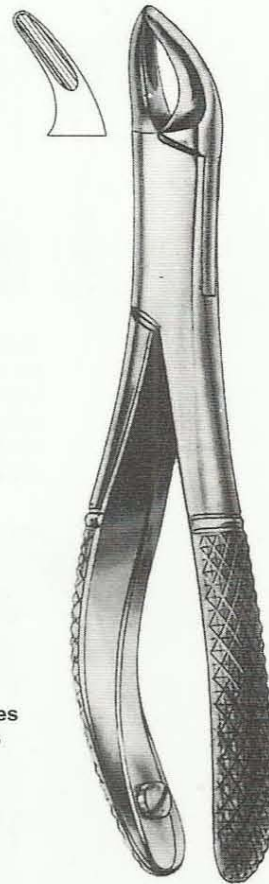

786-616
Fig:150SK
obere Zähne und Wurzeln
upper anteriors and roots
dents et racines supérieures
dientes y raíces superiores

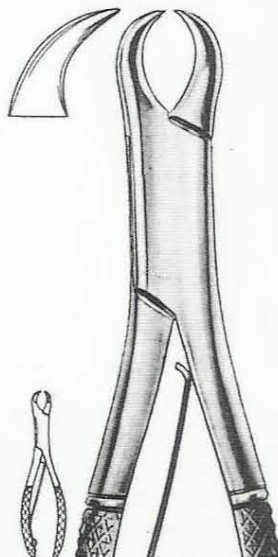

786-615
Fig:23SK
untere Molaren
lower molars
molaires inférieures
molares inferiores

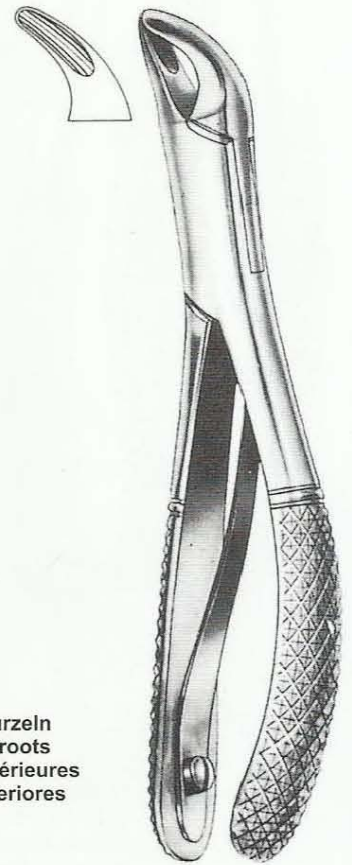

786-617
Fig:151SK
untere Zähne und Wurzeln
lower anteriors and roots
dents et racines inférieures
dientes y raíces inferiores

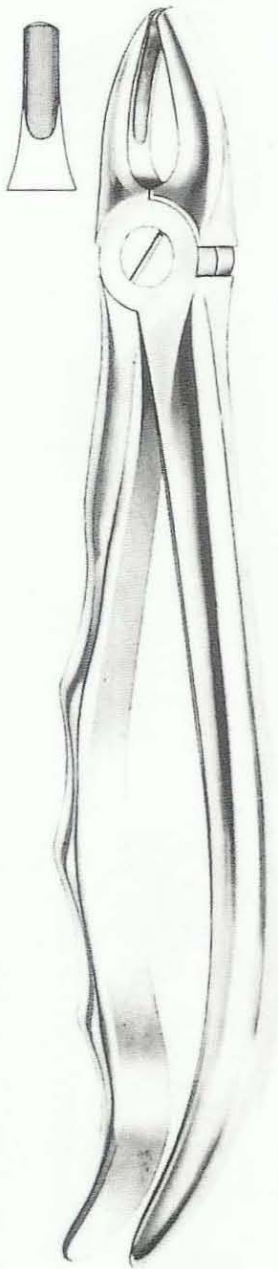

786-618
 Fig:1
 obere Schneide- und Eckzähne
 upper laterals and canines
 incisives et canines supérieures
 incisivos y caninos superiorse

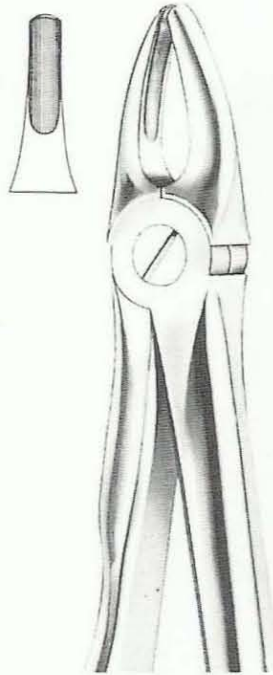

786-619
 Fig:2
 obere Schneide- und Eckzähne
 upper laterals and canines
 incisives et canines supérieures
 incisivos y caninos superiorse

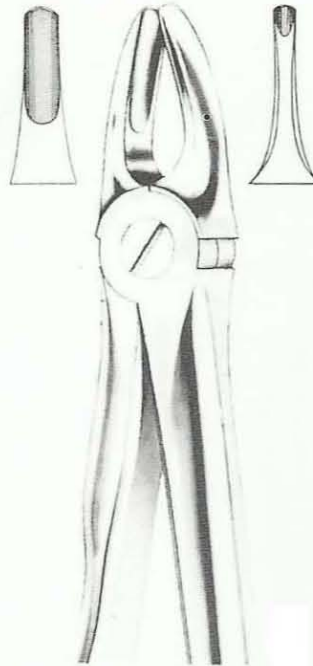

786-620
 Fig:3
 obere Schneide- und Eckzähne
 upper incisors and canines
 incisives et canines supérieures
 incisivos y caninos superiorse

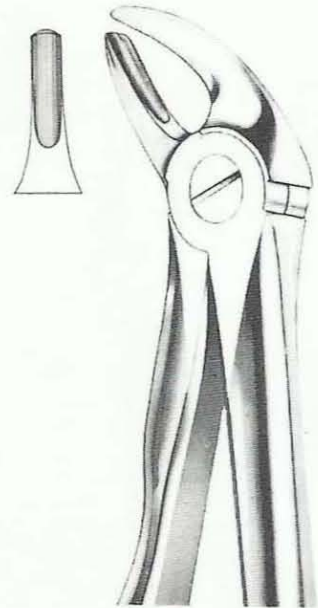

786-621
 Fig:4
 untere Schneide- und Eckzähne
 lower incisors and canines
 incisives et canines supérieures
 incisivos y caninos superiorse



786-622
 Fig:7
 obere Prämolaren
 upper premolars
 prémolaires supérieures
 premolares superiorse

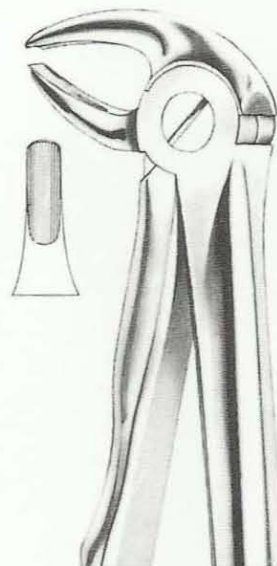

786-623
 Fig:13
 untere Prämolaren
 lower premolars
 prémolaires inférieures
 premolares inferiores

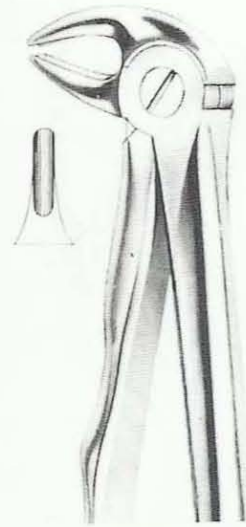

786-624
 Fig:13S
 untere Prämolaren
 für Kinder
 lower premolars,
 for children
 prémolaires inférieures,
 pour enfants
 premolares inferiores,
 para niños

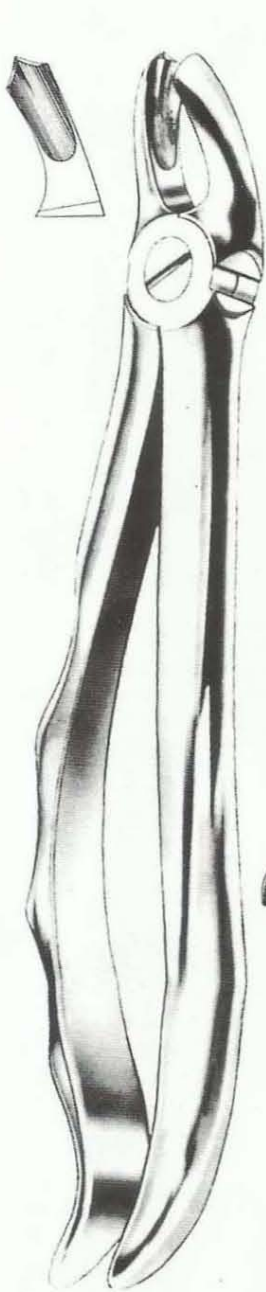

786-626
 Fig:18
 obere Molaren. Links
 upper molars. Left
 molairs supérieureures gauches
 molares superiores izquierdos

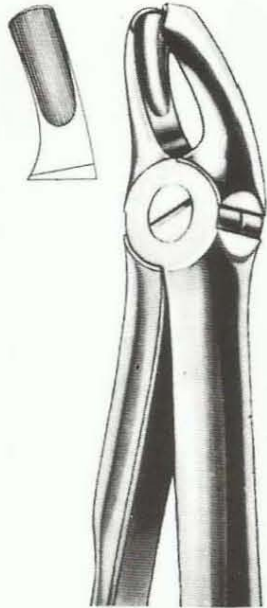

786-627
 Fig:18A
 obere Molaren
 upper molars
 molairs supérieures
 molares superiores

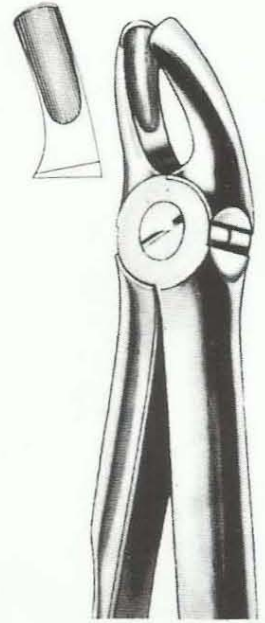

786-628
 Fig:18B
 obere Molaren
 upper molars
 molairs supérieures
 molares superiores

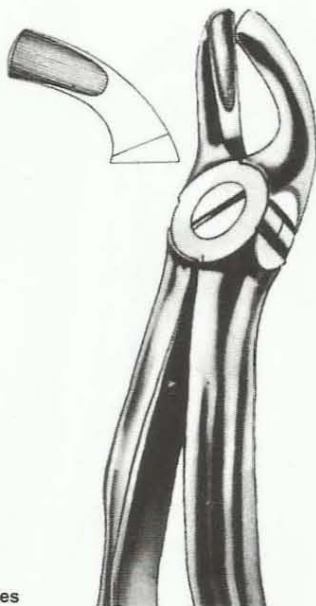

786-625
 Fig:17
 obere Molaren, rechts
 upper molars, right
 molaires Superieures droites
 molares superiores derechos

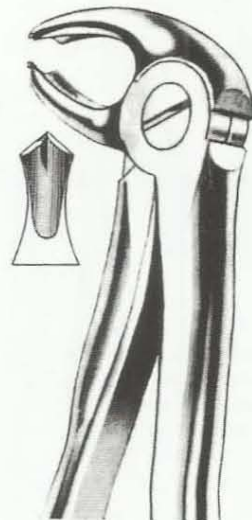

786-629
 Fig:19
 obere dritte molaren
 upper third molars
 troisièmes molaires
 supérieures
 terceros molares
 superiores

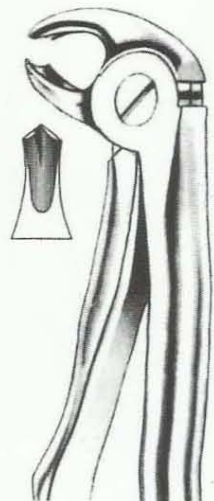

786-630
 Fig:22
 obere dritte molaren
 upper third molars
 troisièmes molaires
 supérieures
 terceros molares
 superiores

786-631
 Fig:22S
 untere Molaren.
 Fur kinder
 lower molars,
 for children
 Molaires inférieures.
 Pour enfants
 molares inferiores.
 Para niños

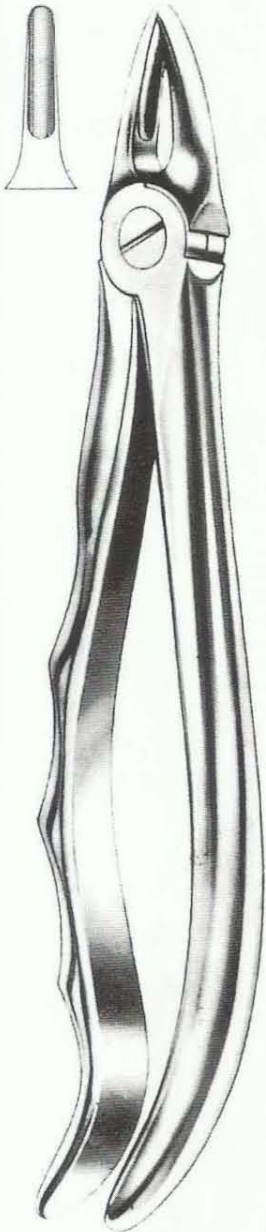

786-632
 Fig:29
 obere Wurzeln
 upper roots
 racines supérieures
 raices superiores

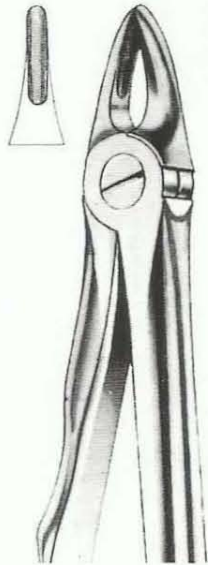

786-633
 Fig:29S
 obere Wurzeln,
 für Kinder
 upper roots,
 for children
 racines supérieures,
 pour enfants
 raices superiores,
 para niños



786-634
 Fig:30
 obere Wurzeln,
 upper roots
 racines supérieures
 raices superiores



786-635
 Fig:30S
 obere Wurzeln,
 für Kinder
 upper roots,
 for children
 racines supérieures,
 pour enfants
 raices superiores,
 para niños



786-636
 Fig:33
 untere Wurzeln
 lower roots
 racines inférieures
 raices inferiores



786-637
 Fig:33A
 untere Wurzeln
 lower roots
 racines inférieures
 raices inferiores

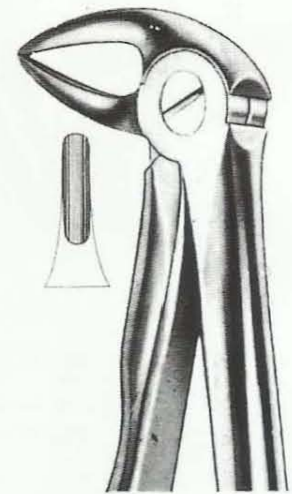

786-638
 Fig:33B
 untere Wurzeln
 lower roots
 racines inférieures
 raices inferiores



786-639
 Fig:33L
 untere Wurzeln
 lower roots
 racines inférieures
 raices inferiores

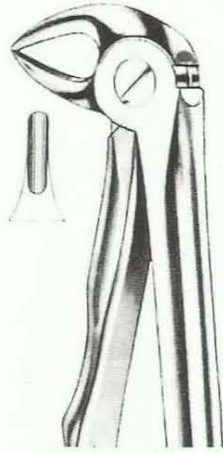

786-640'
 Fig:33S
 untere Wurzeln,
 für Kinder
 lower roots,
 for children
 racines inférieures,
 pour enfants
 raices inferiores
 para niños

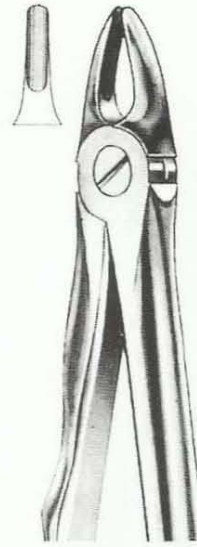

786-641
 Fig:37
 obere Schneidezähne,
 für Kinder
 upper incisors,
 for children
 incisives supérieures,
 pour enfants
 incisivos superiores
 para niños

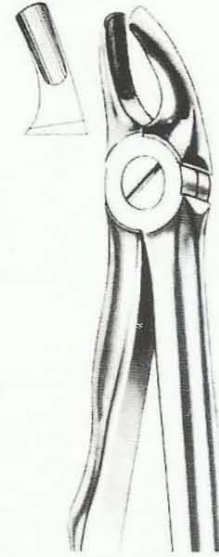

786-642
 Fig:39
 obere Molaren,
 für Kinder
 upper Molars,
 for children
 molaires supérieures,
 pour enfants
 molares superiores,
 para niños

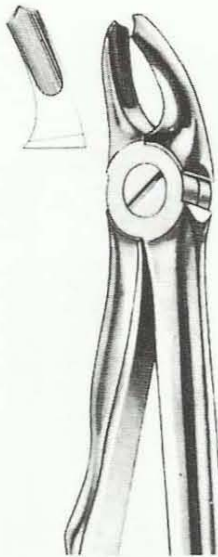

786-643
 Fig:39A
 obere Molaren,
 für Kinder
 Upper molars,
 for children
 molaires supérieures,
 pour enfants
 molares superiores,
 para niños



786-644
 Fig:39R
 obere Molaren rechts,
 für Kinder
 Upper molars right
 for children
 molaires supérieures,
 droites, pour enfants
 molares superiores
 derechos, para niños



786-645
 Fig:39L
 obere Molaren links,
 für Kinder
 Upper molars left,
 for children
 molaires supérieures gauches,
 pour enfants
 molares superiores izquierdos,
 para niños

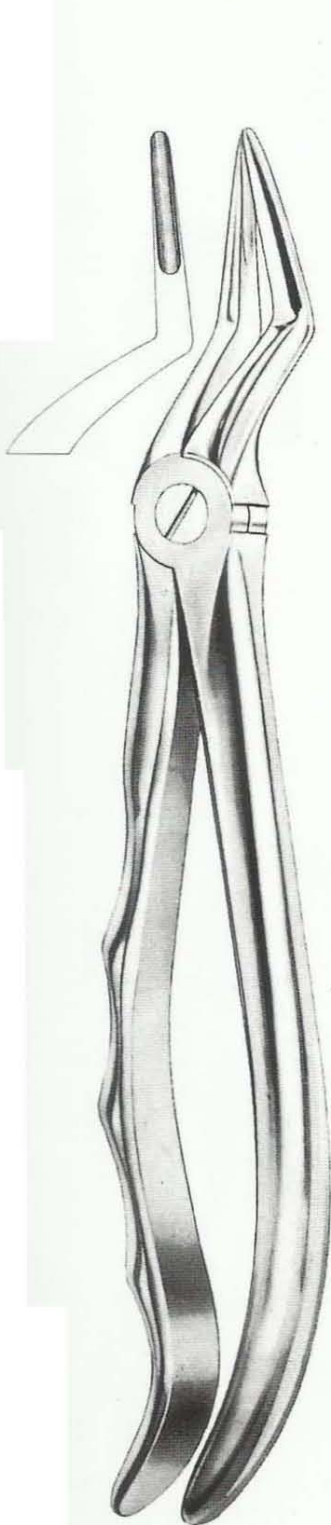

786-646
 Fig:51L
 obere Wurzeln
 upper roots
 racines supérieures
 raíces superiores

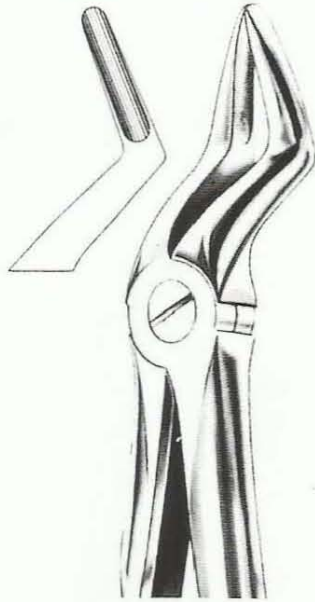

786-647
 Fig:52
 obere Wurzeln
 upper roots
 racines supérieures
 raíces superiores

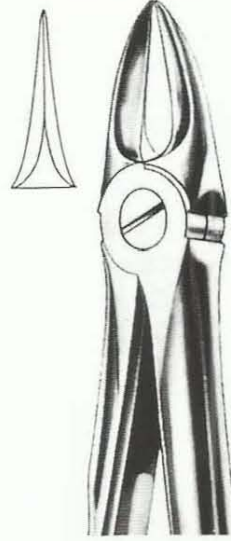

786-648
 Fig:54
 Spaltzange für obere
 Molaren
 for separating upper molars
 à séparer molaires
 supérieures
 para separar molares
 superiores

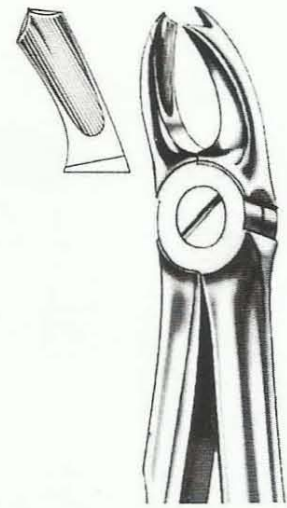

786-649
 Fig:65R
 obere Molaren, rechts
 upper molars, right
 molaires supérieures
 droites
 molares superiores
 derechos



786-650
 Fig:65L
 obere Molaren, links
 upper molars, left
 molaires supérieures
 gauches
 molares superiores
 izquierdos

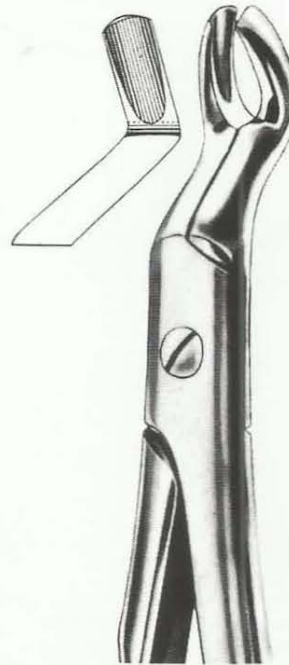

786-651
 Fig:67
 obere dritte Molaren
 upper third molars
 troisièmes molaires
 supérieures
 terceros molares
 superiores

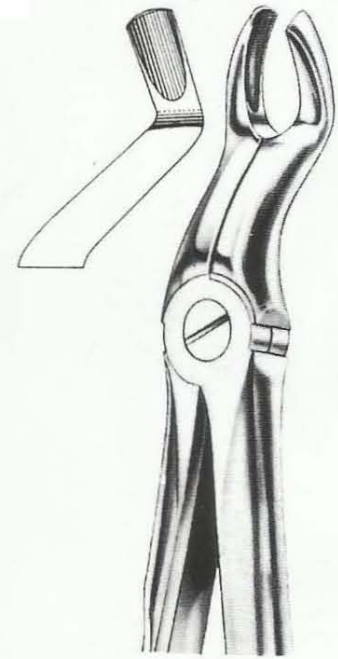

786-652
 Fig:67A
 obere dritte Molaren
 upper third molars
 troisièmes molaires
 supérieures
 terceros molares
 superiores

Extracting Forceps with fitting handles
 Daviers avec manche d'ajustage
 Forceps de Extracción con mango adaptado a la mano

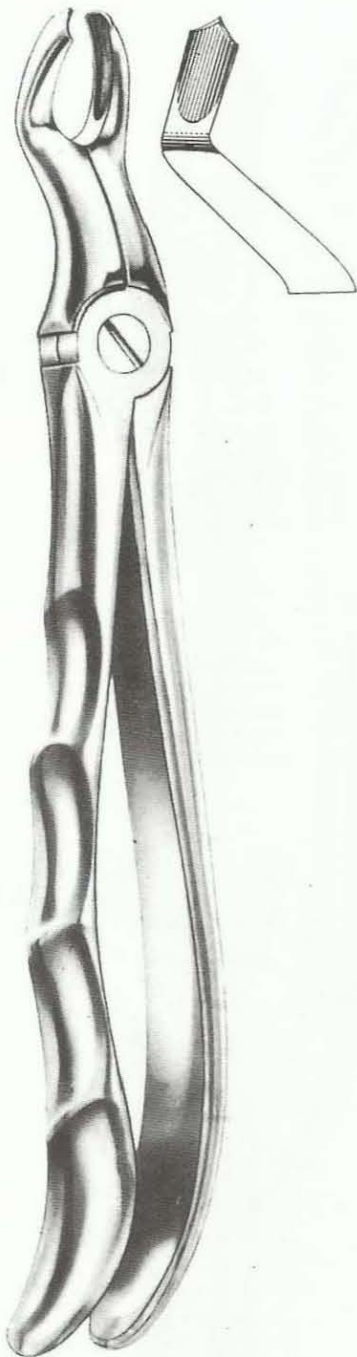

786-653
 Fig:67½ R
 obere dritte Molaren, rechts
 upper third molars, right
 troisièmes molaires
 supérieures, droites
 terceros molares
 superiores, derechos

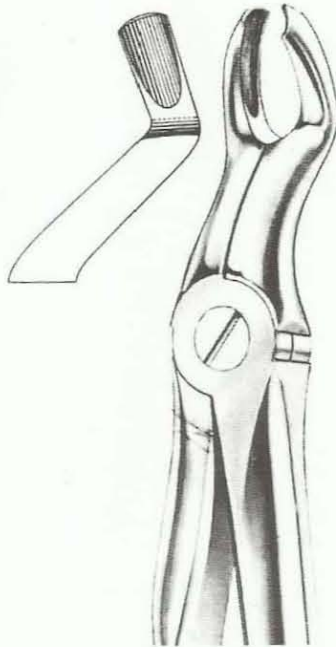

786-654
 Fig:67½ L
 obere dritte Molaren, links
 upper third molars, left
 troisièmes molaires
 supérieures, gauches
 terceros molares
 superiores, izquierdos

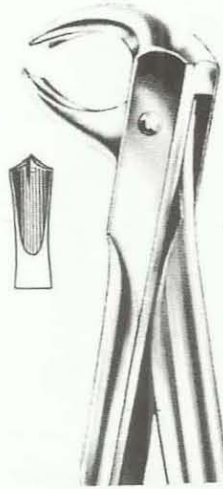

786-655
 Fig:73
 untere Molaren
 lower molars
 molaires inférieures
 molares inferiores

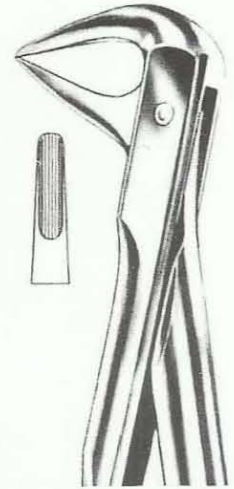

786-656
 Fig:74
 untere Wurzein
 lower roots
 racines inférieures
 raíces inferiores

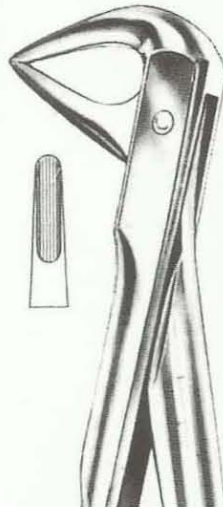

786-657
 Fig:74M
 untere Wurzein
 lower roots
 racines inférieures
 raíces inferiores

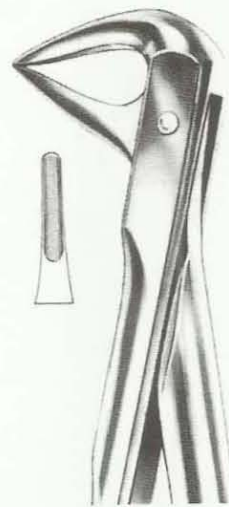

786-658
 Fig:74N
 untere Wurzein
 lower roots
 racines inférieures
 raíces inferiores

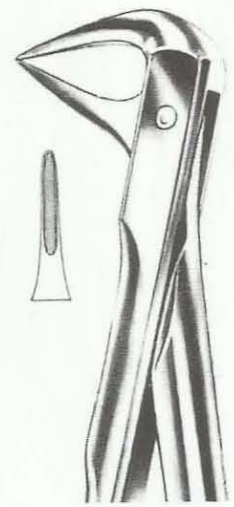

786-659
 Fig:74XN
 untere Wurzein und eng-
 stehende Schneidezähne
 lower roots and crowded
 incisors
 racines inférieures et
 raíces inferiores e incisivo
 supernumerarios

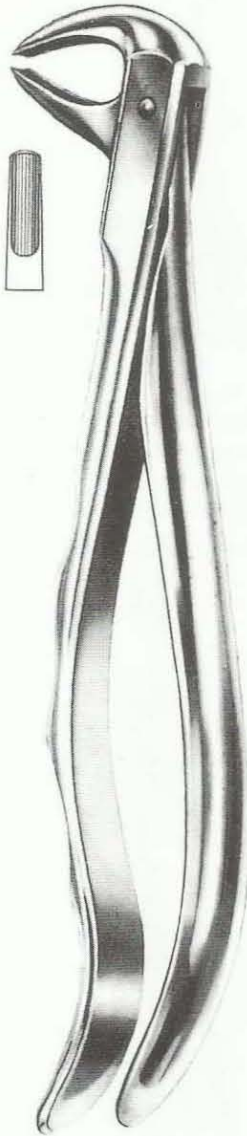

786-660
 Fig:75
 untere Prämolaren
 lower premolars
 prémolaires inférieures
 premolares inferiores

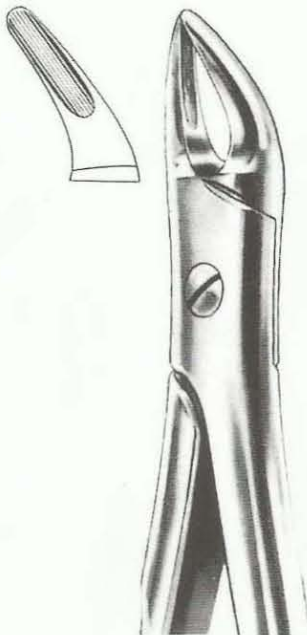

786-661
 Fig:76
 obere Wurzeln
 upper roots
 racines supérieures
 raíces superiores



786-662
 Fig:76N
 obere Wurzeln
 upper roots
 racines supérieures
 raíces superiores

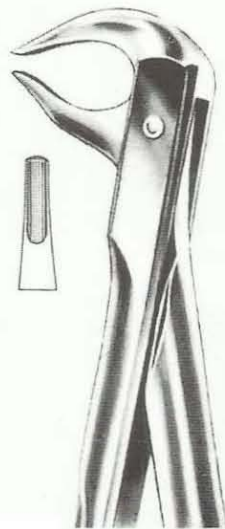

786-663
 Fig:81
 untere Prämolaren
 und Wurzeln
 lower premolars
 and roots
 prémolaires et racines
 inférieures
 premolares y raíces
 inferiores

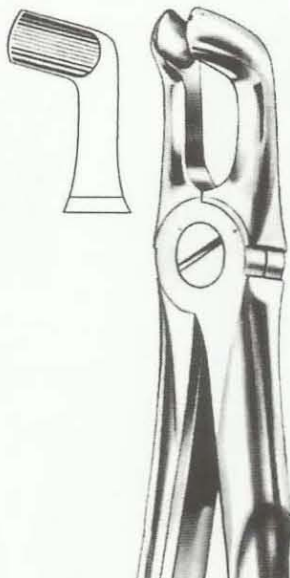

786-664
 Fig:79A
 untere dritte Molaren
 lower third molars
 troisièmes molaires inférieures
 terceros molares inferiores

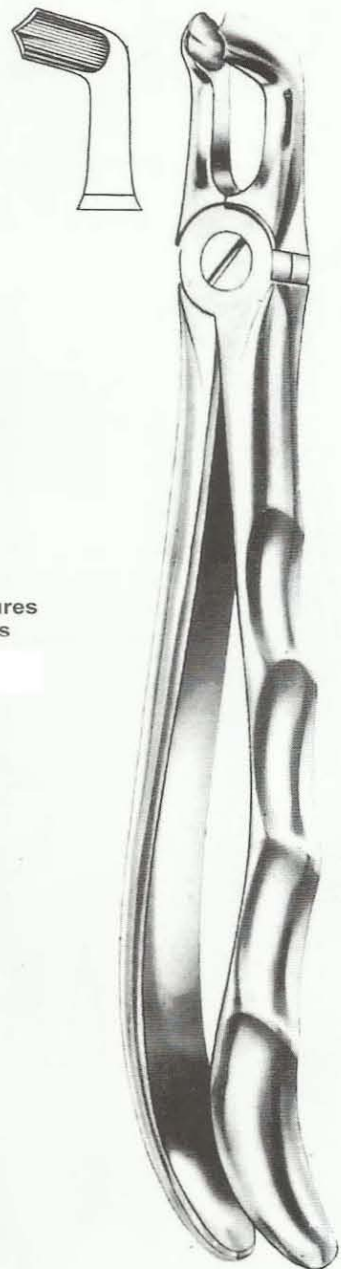

786-665
 Fig:79
 untere dritte Molaren
 lower third molars
 troisièmes molaires inférieures
 terceros molares inferiores

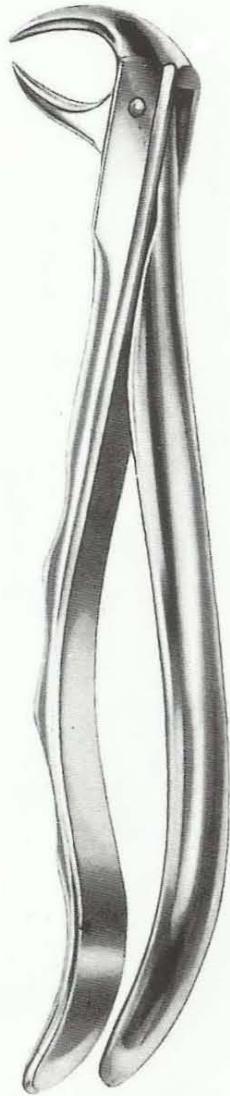

786-666
 Fig:86A
 untere Molaren
 lower molars
 molaires inférieures
 molares inferiores

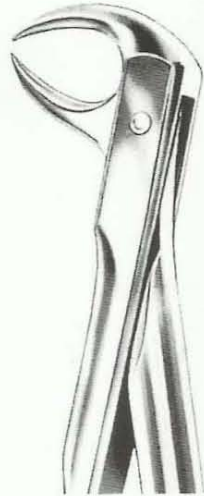

786-667
 Fig:86B
 untere Molaren
 lower molars
 molaires inférieures
 molares inferiores

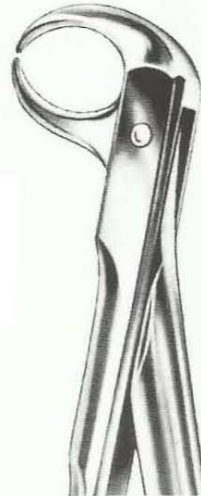

786-668
 Fig:86C
 untere Molaren
 lower molars
 molaires inférieures
 molares inferiores

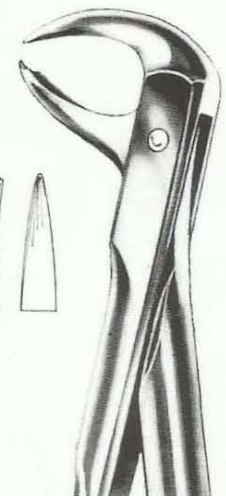
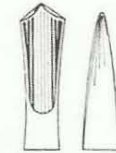

786-669
 Fig:99
 untere Molaren
 lower molars
 molaires inférieures
 molares inferiores

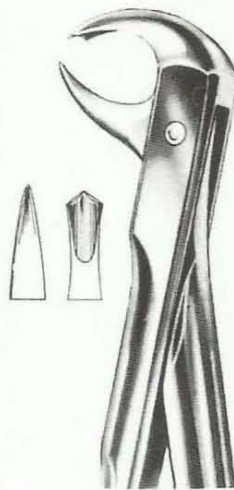

786-670
 Fig:99 1/4
 untere Molaren
 lower molars
 molaires inférieures
 molares inferiores

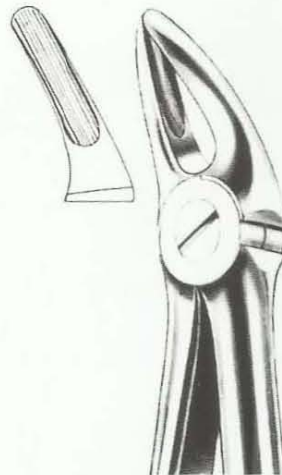

786-671
 Fig:136
 obere Prämolaren und Wurzeln
 upper premolars and roots
 prémolaires et racines supérieures
 premolares y raíces superiores

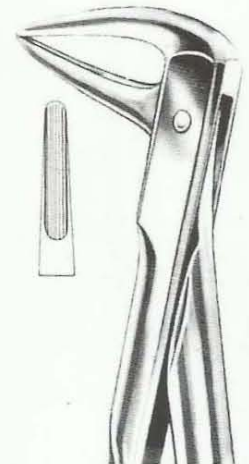

786-672
 Fig:143
 untere Wurzeln
 lower roots
 racines inférieures
 raíces inferiores

Extracting Forceps with fitting handles
 Daviers avec manche d'ajustage
 Forceps de Extracción con mango adaptado a la mano

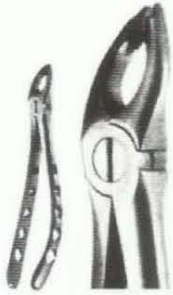

786-673
Fig:F1
UPPER UNIVERSAL

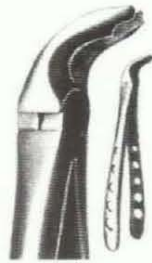

786-674
Fig:F2
LOWER UNIVERSAL



786-675
Fig:F3
UPPER ANTERIOR



786-676
Fig:F4
LOWER ANTERIOR



786-677
Fig:F5
LOWER ANTERIOR



786-678
Fig:F6
UPPER 3RD MOLAR

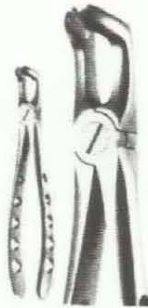

786-679
Fig:F7
LOWER 3RD MOLAR



786-680
Fig:F8
UPPER UNIVERSAL



786-681
Fig:F9
LOWER UNIVERSAL



786-682
Fig:F10
LOWER MOLAR



786-683
Fig:F11
UPPER LEFT MOLAR

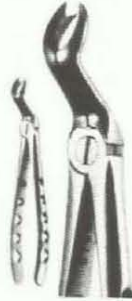

786-684
Fig:F12
UPPER RIGHT MOLAR



786-685
Fig:F13
UPPER LEFT MOLAR



786-686
Fig:F14
UPPER RIGHT MOLAR



786-687
Fig:F15
UPPER MOLAR
UNIVERSAL



786-688
Fig:F16
UPPER ROOT

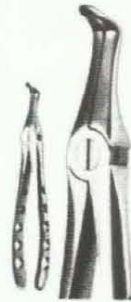

786-689
Fig:F17
LOWER ROOT



786-690
Fig:F18
UPPER ROOT FRAGMENT
NARROW



786-691
Fig:F19
LOWER ROOT FRAGMENT
NARROW

Luxating Elevator Set Of 7



786-692 to 786-698
Luxating Elevator
(Set Of 7)



786-692



786-693



786-694



786-695



786-696



786-697



786-698



786-699
 Fig:1
 Bein 2 mm



786-700
 Fig:2
 Bein 3 mm



786-701
 Fig:3
 Bein 4 mm



786-702
 Fig:4
 Bein 2.5 mm



786-703
 Fig:5
 Bein 3 mm



786-704
 Fig:6
 Bein 4 mm



786-705
 Fig:7
 White

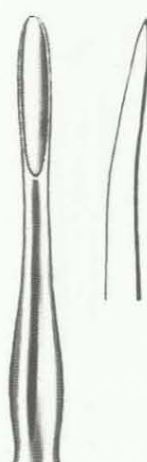

786-706
 Fig:8
 White



786-707
 Fig:9
 Berten

Root elevators
Elévateurs à racines
Elevadores para raices

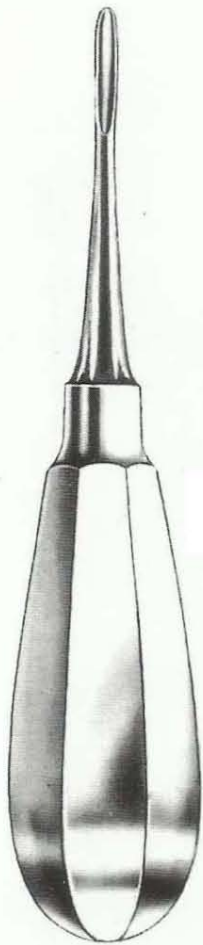

786-708
Fig:1



786-709
Fig:2



786-710
Fig:3



786-711
Fig:4



786-712
Fig:5



786-713
Fig:6



786-714
Fig:7



786-715
Fig:8



786-716
Fig:9



786-717
Fig:10



786-718
Fig:11



786-719
Fig:12

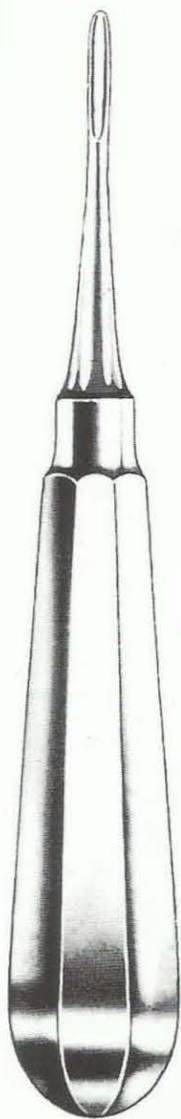

786-720
 Fig:1



786-721
 Fig:2
 Flohr



786-722
 Fig:3
 Flohr



786-723
 Fig:4
 Flohr



786-724
 Fig:5
 Friedman



786-725
 Fig:6
 Friedman



786-726
 Fig:7
 Friedman



786-727
 Fig:8
 Heidbrink



786-728
 Fig:9
 Heidbrink



786-729
 Fig:10
 Heidbrink



786-730
 Fig:11



786-731
 Fig:12



786-732
 Fig:13
 Flohr



786-733
 Fig:14

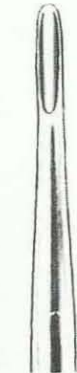

786-734
 Fig:15



786-735
 Fig:16



786-736
 Fig:17



786-737
 Fig:18



786-738
 Fig:19
 Lindo-Levien

Root elevators
 Elévateurs à racines
 Elevadores para raices

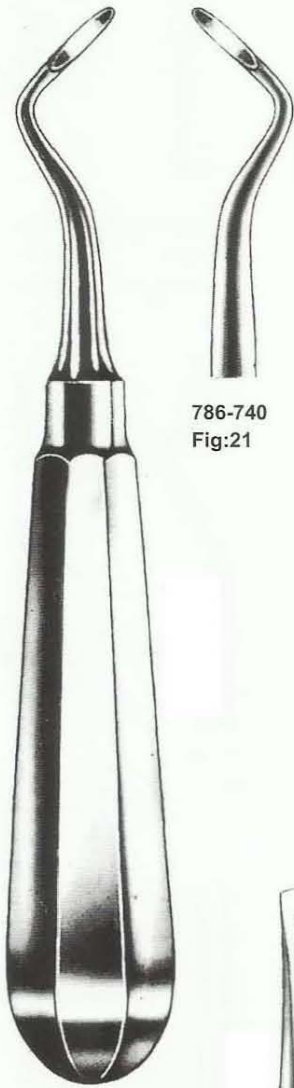

786-739
 Fig:20



786-740
 Fig:21

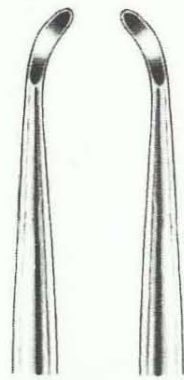

786-741
 Fig:22
 Miller1

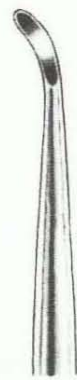

786-742
 Fig:23
 Miller2

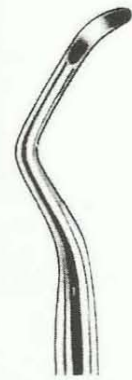

786-743
 Fig:24
 Miller3



786-744
 Fig:25
 Miller4

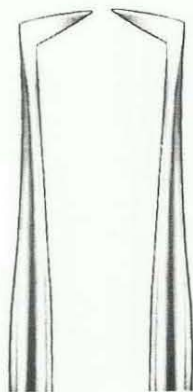

786-745
 Fig:26



786-746
 Fig:27

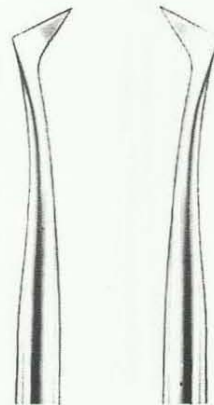

786-747
 Fig:28



786-748
 Fig:29



786-749
 Fig:30



786-750
 Fig:31



786-751
 Fig:20
 Flohr

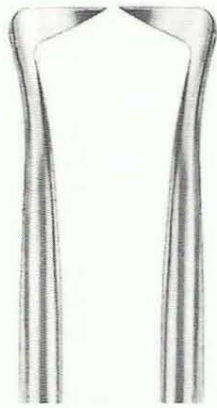

786-752
 Fig:21
 1L Seldin



786-753
 Fig:22
 1R Seldin



786-754
 Fig:23
 4L Seldin



786-755
 Fig:24
 4R Seldin



786-756
 Fig:25



786-757
 Fig:26



786-758
 Fig:27
 27 Cryer

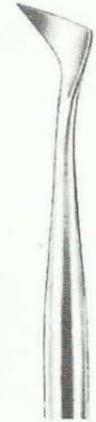

786-759
 Fig:28
 28 Cryer



786-766
 Fig:27S
 27S Cryer



786-761
 Fig:28S
 28S Cryer

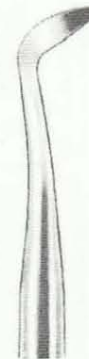

786-762
 Fig:29
 (344)



786-763
 Fig:30
 (345)



786-764
 Fig:31



786-765
 Fig:32



786-766
 Fig:33
 Miller1



786-767
 Fig:34
 Miller2

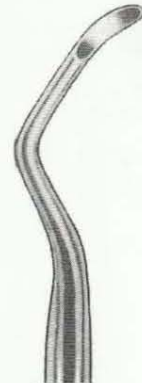

786-768
 Fig:35
 Miller3

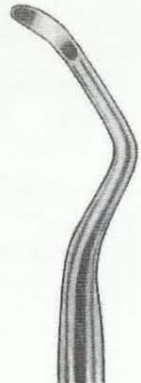

786-769
 Fig:36
 Miller4

Root elevators
 Elévateurs à racines
 Elevadores para raices

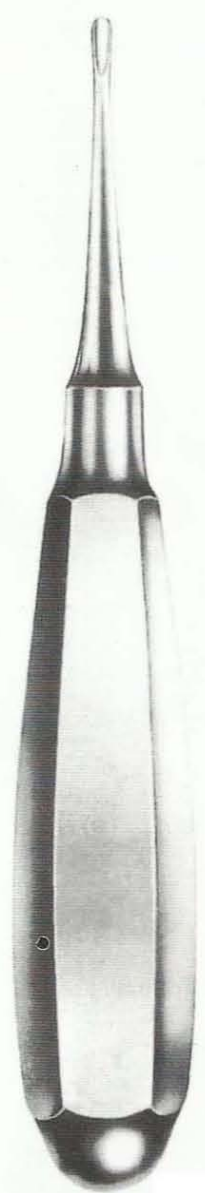

786-770
 Fig:1
 Apical 301

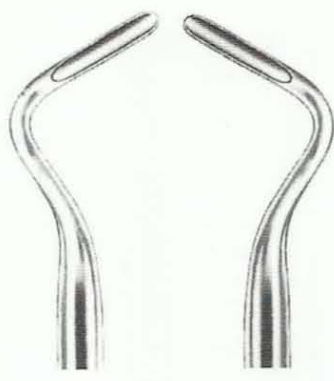

786-771
 Fig:2
 Apical 302

786-772
 Fig:3
 Apical 303



786-773
 Fig:4
 Apical 304



786-774
 Fig:5
 12A



786-775
 Fig:6
 34S Seldin



786-776
 Fig:7
 34 Seldin



786-777
 Fig:8



786-778
 Fig:9
 Flohr



786-779
 Fig:10
 Flohr



786-780
 Fig:11
 Flohr



786-781
 Fig:12
 3 Seldin



786-782
 Fig:13

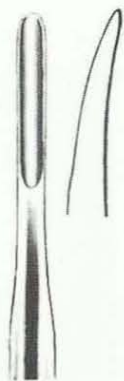

786-783
 Fig:14
 3A Cryer



786-784
 Fig:15
 2 Seldin



786-785
 Fig:16
 12 Cryer

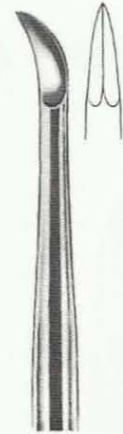

786-786
 Fig:17
 5 Seldin



786-787
 Fig:18
 Crane
 Pick

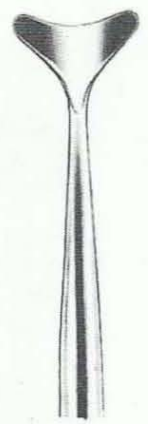

786-788
 Fig:19

Root elevators
 Elévateurs à racines
 Elevadores para raices



786-789
 Fig:1
 Apical 301



786-790
 Fig:2
 Apical 302

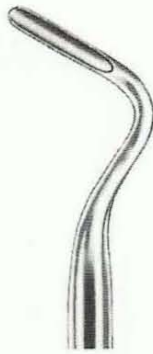

786-791
 Fig:3
 Apical 303



786-792
 Fig:4
 Apical 304



786-793
 Fig:5
 12A



786-794
 Fig:6
 34S Seldin



786-795
 Fig:7
 34 Seldin



786-796
 Fig:8



786-797
 Fig:9
 Flohr

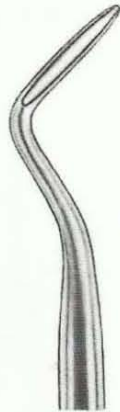

786-798
 Fig:10
 Flohr



786-799
 Fig:11
 Flohr



786-800
 Fig:12
 3 Seldin



786-801
 Fig:13

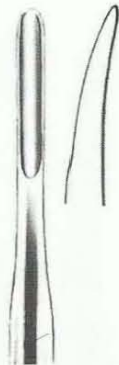

786-802
 Fig:14
 3A Cryer



786-803
 Fig:15
 2 Seldin



786-804
 Fig:16
 12 Cryer



786-805
 Fig:17
 5 Seldin

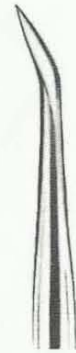

786-806
 Fig:18
 Crane
 Pick

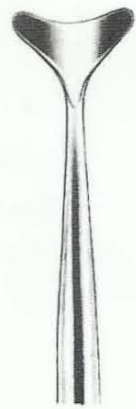

786-807
 Fig:19

Root elevators
 Elévateurs à racines
 Elevadores para raices



786-808
 Fig:20
 Flohr

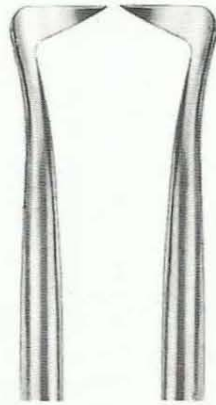

786-809
 Fig:21
 1L Seldin

786-810
 Fig:22
 1R Seldin

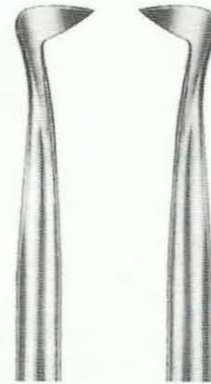

786-811
 Fig:23
 4L Seldin

786-812
 Fig:24
 4R Seldin

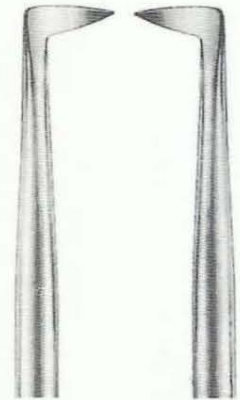

786-813
 Fig:25

786-814
 Fig:26

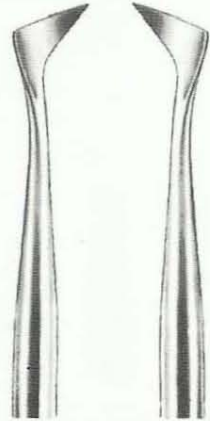

786-815
 Fig:27
 27 Cryer

786-816
 Fig:28
 28 Cryer

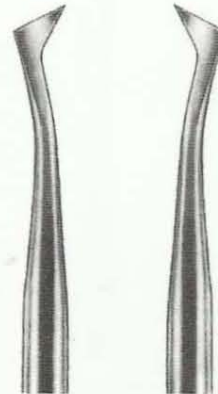

786-817
 Fig:27S
 27S Cryer

786-818
 Fig:28S
 28S Cryer

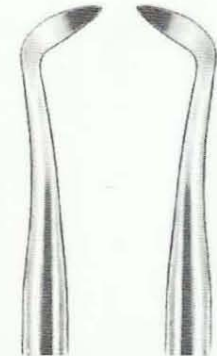

786-819
 Fig:29
 (344)

786-820
 Fig:30
 (345)

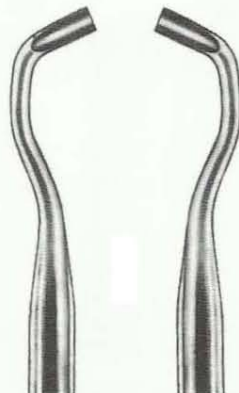

786-821
 Fig:31

786-822
 Fig:32

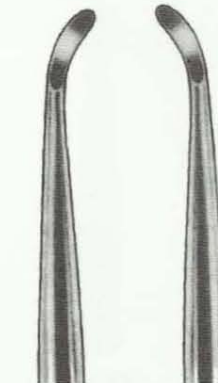

786-823
 Fig:33
 Miller1

786-824
 Fig:34
 Miller2

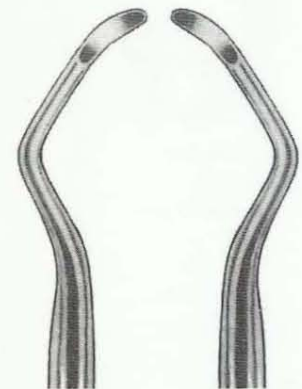

786-825
 Fig:35
 Miller3

786-826
 Fig:36
 Miller4

Root elevators
 Elévateurs à racines
 Elevadores para raices



786-827
 Fig:1
 Bein 3mm



786-828
 Fig:1
 Bein 3mm



786-829
 Fig:2
 Bein 4mm



786-830
 Fig:3
 Bein 3mm



786-831
 Fig:4
 Bein 4mm



786-832
 Fig:5



786-833
 Fig:6



786-834
 Fig:1
 Ratzow



786-835
 Fig:1
 Ratzow



786-836
 Fig:2
 Ratzow



786-837
 Fig:3
 Ratzow



786-838
 Fig:1
 Hylin
 4 mm



786-839
 Fig:1
 Hylin
 4.5 mm



786-840
 Fig:2
 Hylin
 3 mm



786-841
 Fig:3
 Hylin
 3 mm



786-842
 Fig:4
 Hylin
 3 mm

Root elevators
 Élévateurs à racines
 Elevadores para raices

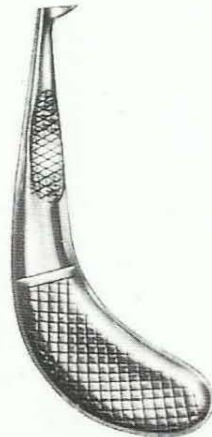

786-843
 Fig:1



786-844
 Fig:1



786-845
 Fig:2

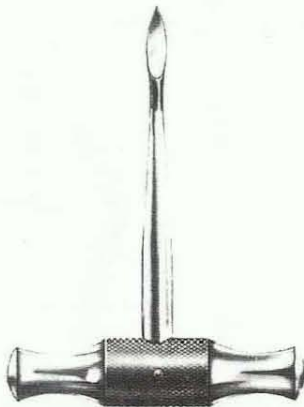

786-846
 Fig:1
 Lecluse

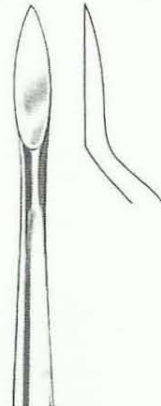

786-847
 Fig:1
 Lecluse

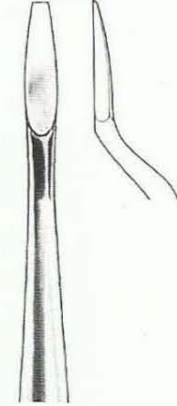

786-848
 Fig:2
 Lecluse

Wurzelspitzenheber

Apical Fragment Ejectors
 Élévateurs à fragments
 Elevadores para fragmentos



786-849
 Fig:1
 Heidbrink



786-850
 Fig:1
 Heidbrink



786-851
 Fig:2
 Heidbrink



786-852
 Fig:3
 Heidbrink



786-853
 Fig:1
 Chompret
 Syndesmotome
 Syndesmotomes
 Sindesmótomos



786-854
 Fig:2
 Chompret



786-855
 Fig:2
 Chompret



786-856
 Fig:3
 Chompret



786-857
 Fig:4
 Chompret

Root elevators
 Elévateurs à racines
 Elevadores para raices

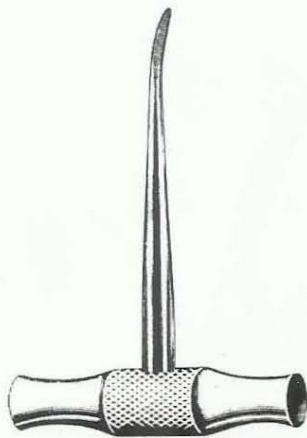

786-858
 Fig:1
 Winter
 1 L



786-859
 Fig:1
 Winter
 1 L



786-860
 Fig:2
 Winter
 1 R



786-861
 Fig:3
 Winter
 11 L



786-862
 Fig:4
 Winter
 11 R



786-863
 Fig:5
 Winter
 12 L



786-864
 Fig:6
 Winter
 12 R



786-865
 Fig:7
 Winter
 13 L



786-866
 Fig:8
 Winter
 13 R



786-867
 Fig:9
 Winter
 14 L



786-868
 Fig:10
 Winter
 14 R



786-869
 Fig:11
 Mead 1



786-870
 Fig:12
 Mead 2



786-871
 Fig:13
 Mead 3



786-872
 Fig:14
 Mead 4



786-873
 Fig:15
 Mead 9 A

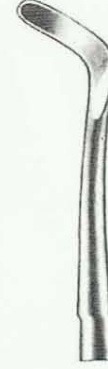

786-874
 Fig:16
 Mead 10 A



786-875
 Fig:17
 Mead 11

Root elevators
 Elévateurs à racines
 Elevadores para raices

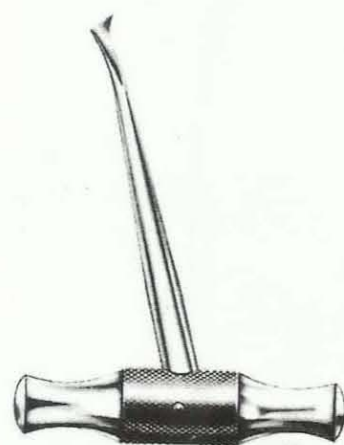

786-876 $\frac{1}{2}$
 Fig:1
 Barry 320



786-877
 Fig:1
 Barry 320



786-878
 Fig:2
 Barry 321



786-879
 Fig:3
 Barry 322



786-880
 Fig:4
 Barry 323



786-881
 Fig:5
 Barry 350



786-882
 Fig:6
 Barry 351



786-883
 Fig:7
 Barry 370



786-884
 Fig:8
 Barry 371



786-885
 Fig:1
 Pott



786-886
 Fig:1
 Pott



786-887
 Fig:2
 Pott



786-888
 Fig:1
 Coupland



786-889
 Fig:1
 Coupland



786-890
 Fig:2
 Coupland



786-891
 Fig:3
 Coupland

Meibel
 Chisels and Gouges
 Ciseaux-burins et Gouges
 Cinceles y Gubias



DIAGNOSTIC

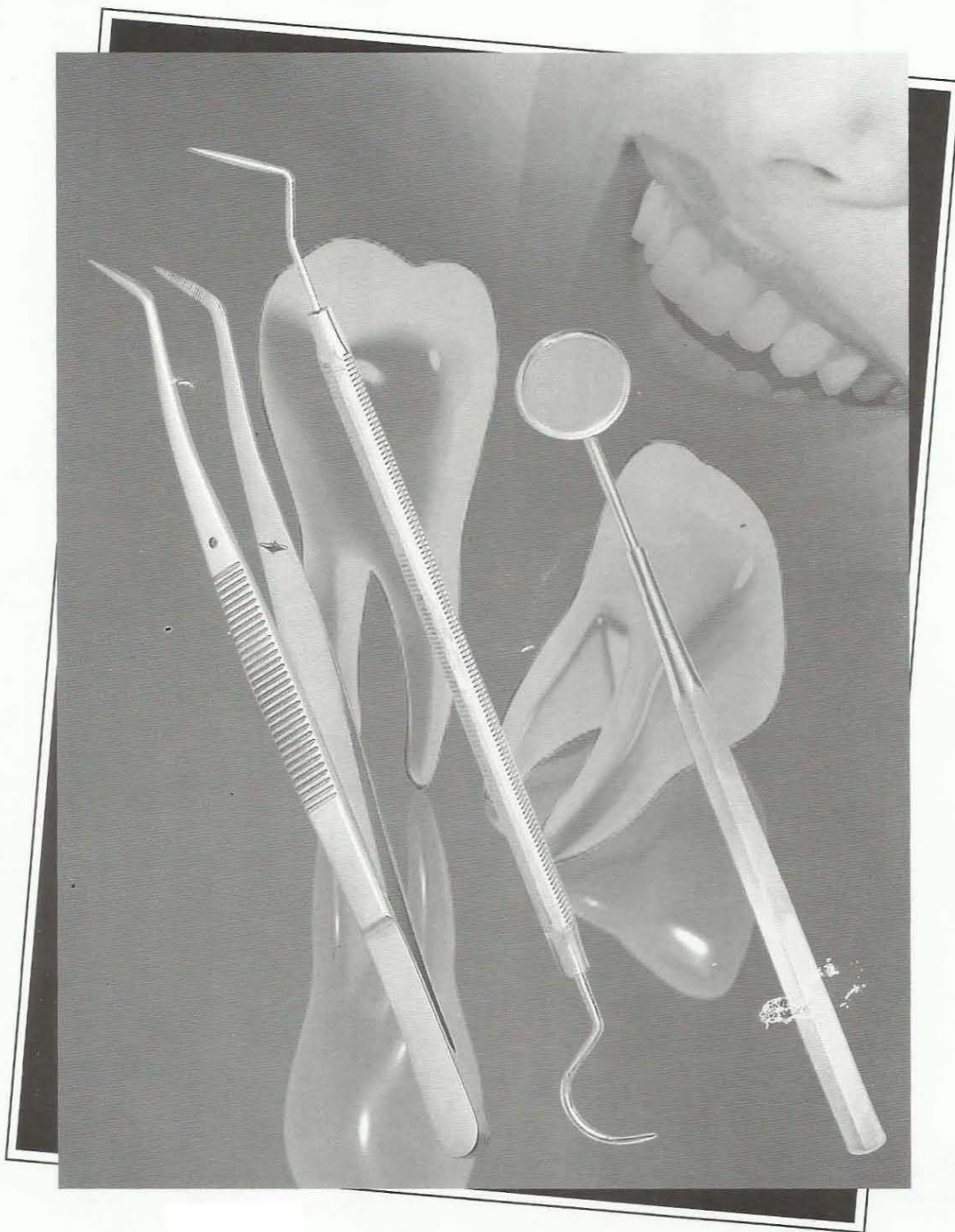

Cotton pliers - Tweezer
 Preceltes - Brucelles
 Pinzas para algodón

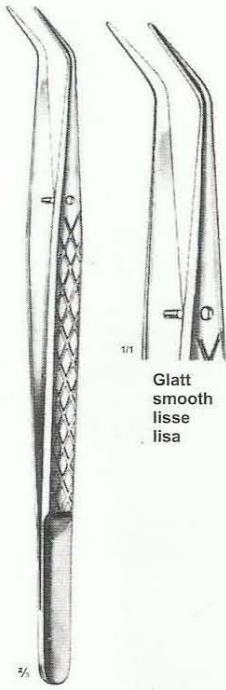

Glatt
smooth
lisse
lisa

786-892
College 15 cm

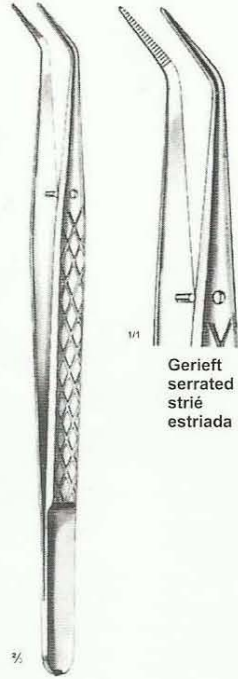

Gerieft
serrated
strié
estriada

786-893
College 15 cm

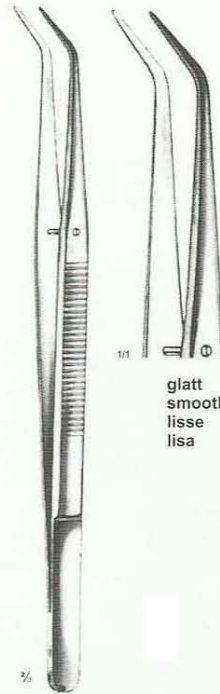

glatt
smooth
lisse
lisa

786-894
College 15 cm

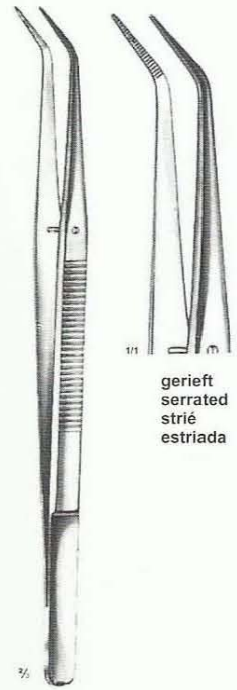

gerieft
serrated
strié
estriada

786-895
College 15 cm

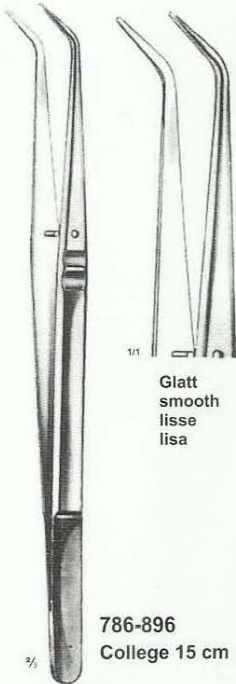

Glatt
smooth
lisse
lisa

786-896
College 15 cm

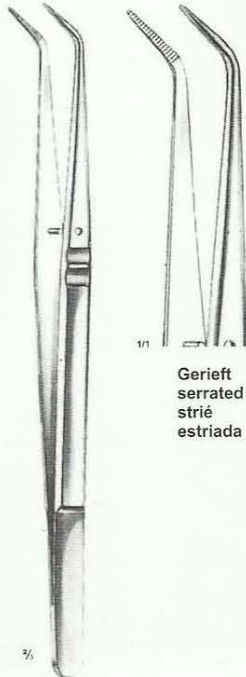

Gerieft
serrated
strié
estriada

786-897
College 15 cm

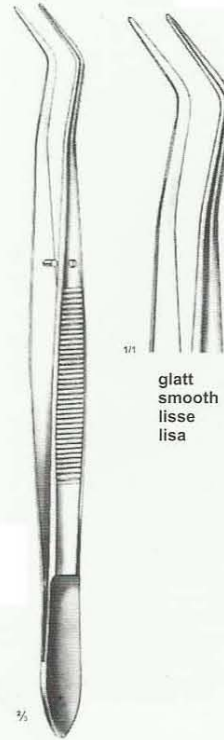

glatt
smooth
lisse
lisa

786-898
Meriam 16 cm

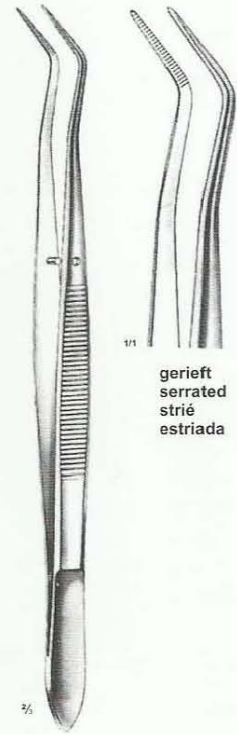

gerieft
serrated
strié
estriada

786-899
Meriam 16 cm

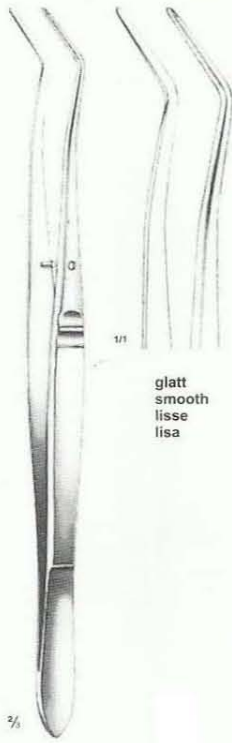

glatt
smooth
lisse
lisa

786-900
Meriam 16 cm

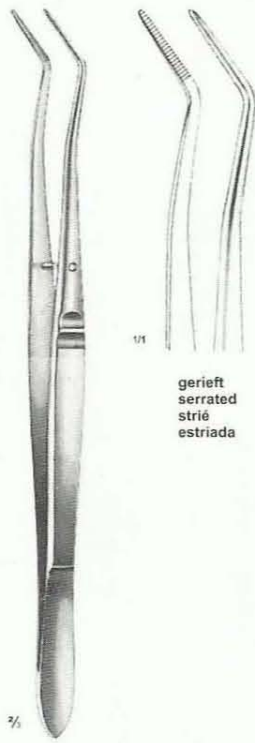

gerieft
serrated
strié
estriada

786-901
Meriam 16 cm

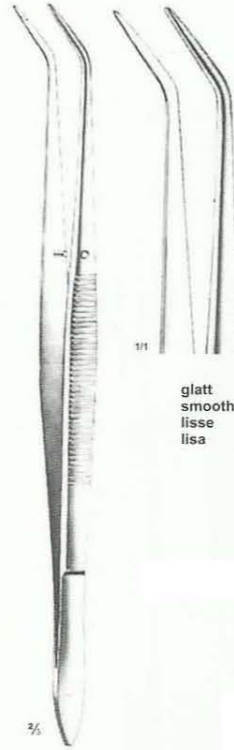

glatt
smooth
lisse
lisa

786-902
Flagg 16 cm

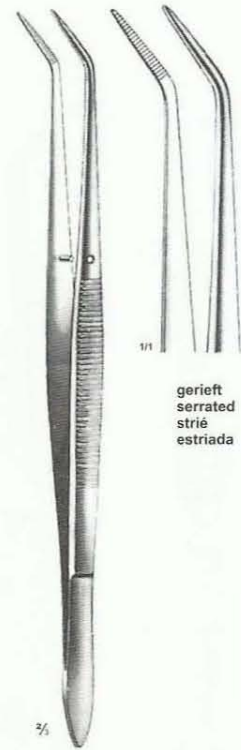

gerieft
serrated
strié
estriada

786-903
Flagg 16 cm

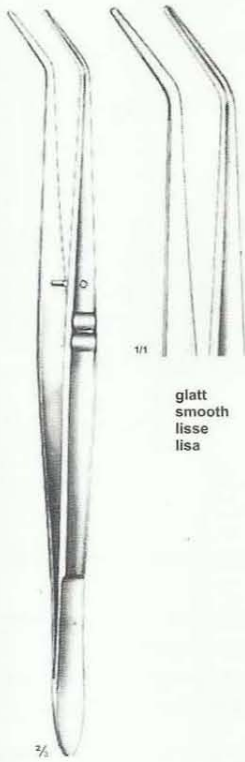

glatt
smooth
lisse
lisa

786-904
Flagg 16 cm



gerieft
serrated
strié
estriada

786-905
Flagg 16 cm

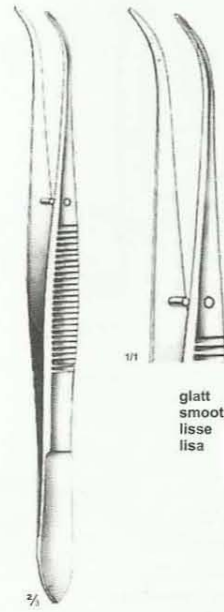

glatt
smooth
lisse
lisa

786-906
perry 13 cm

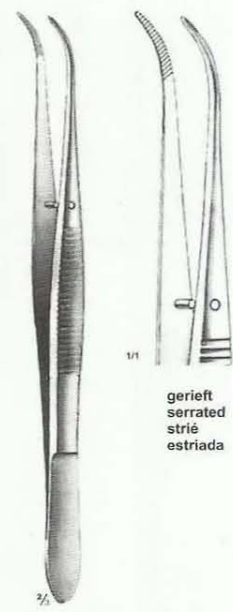

gerieft
serrated
strié
estriada

786-907
perry 13 cm

Cotton pliers - Tweezer
 Precelles - Brucelles
 Pinzas para algodón

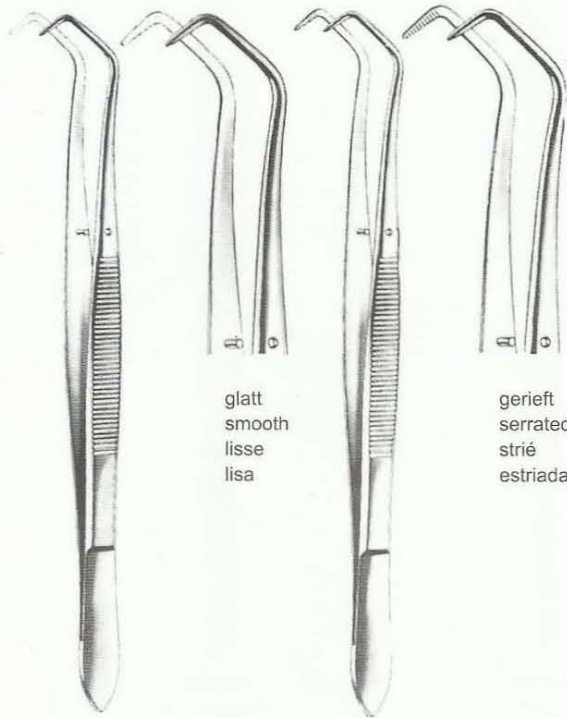

glatt
 smooth
 lisse
 lisa

gerieft
 serrated
 strié
 estriada

786-908/1
 15 cm

786-909/2
 15 cm

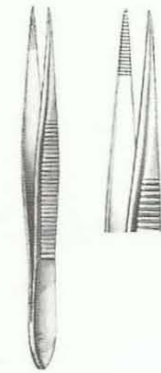

Splitterpinzetten
 Splinter Forceps
 Pinces à échardes
 Pinzas para espinas

786-910
 8 cm

786-911/1
 14,5 cm

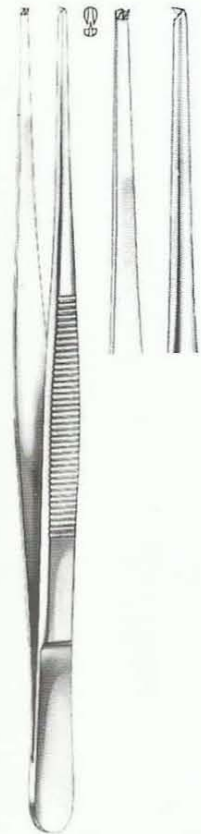

786-912/2
 18 cm



786-913/1

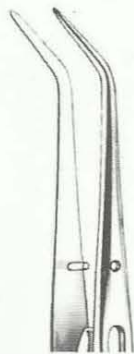

786-914/1

glatt
 smooth
 lisse
 lisa



786-915/2

gerieft
 serrated
 strié
 estriada

mit Schloß
 with ratchet
 avec arrêt
 con cremallera



786-916/1



786-917/1

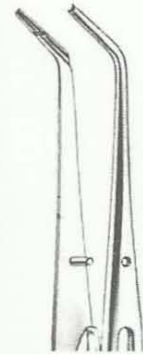

786-918/2

als Tropfpinzette, Stift-und Nervnadelpinzette
 verwendbar
 also suited to hold silver pins, nerve-boraches
 and for introducing medicines
 aussi pour tire-nerfs, pointes, pivots etc. Et em-
 ployable comme pince à gouttes
 también para pernos, puntas, tira-nervios etc. y
 usándose como pinza cuentagotas

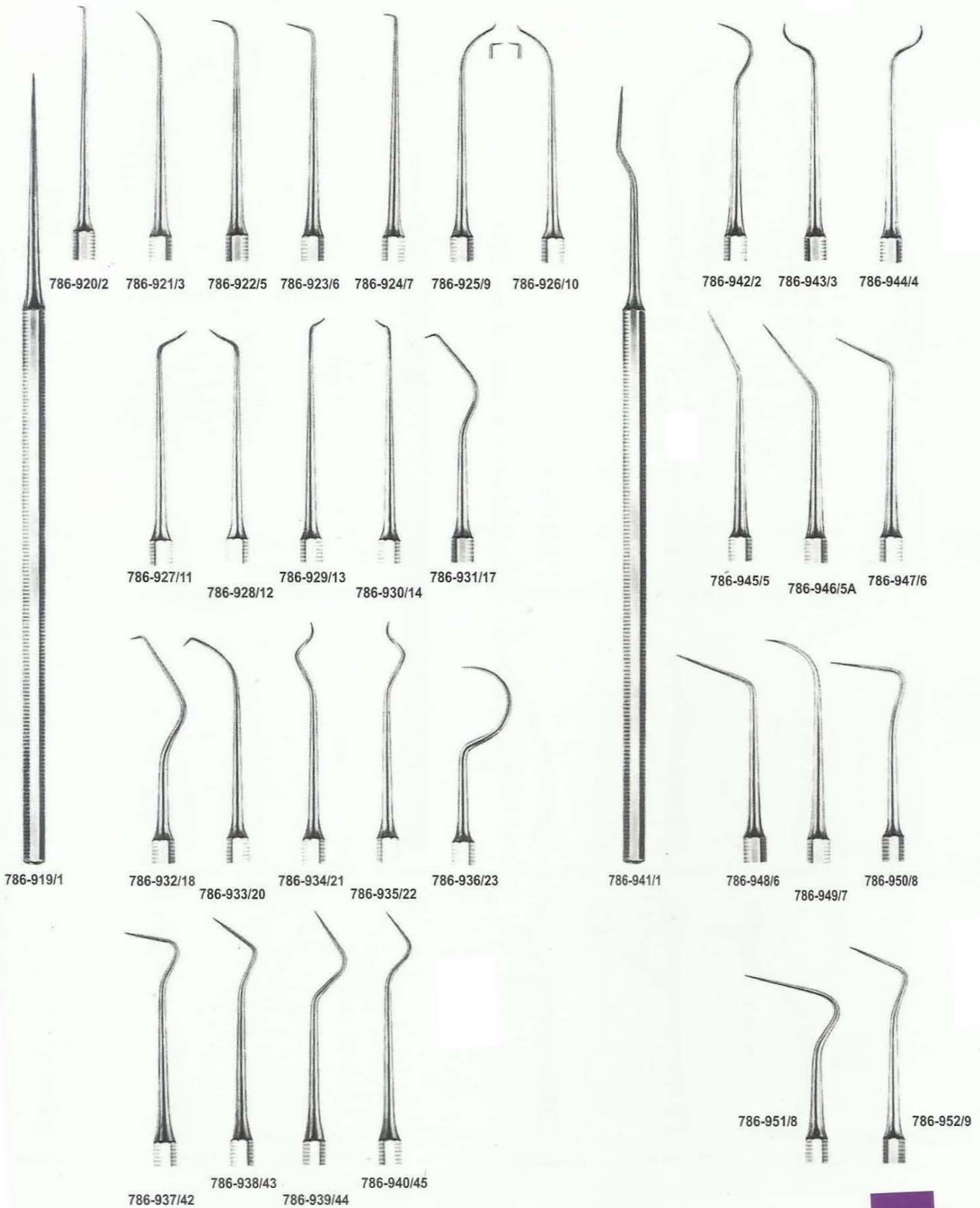

Probes and Explorers
 Sondes et Explorateurs
 Sondas y Exploradores



786-953/1



786-954/2



786-955/17

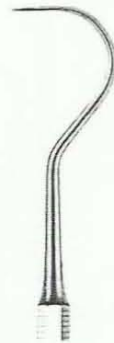

786-956/23



786-966/1



786-967/2



786-968/17



786-969/23



786-957/26

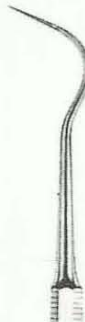

786-958/30



786-959/32



786-970/26



786-971/30



786-972/32



786-960/33



786-961/34



786-962/42



786-973/33



786-974/34

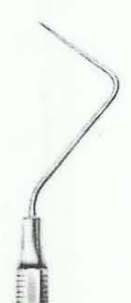

786-975/42



786-963/43



786-964/44

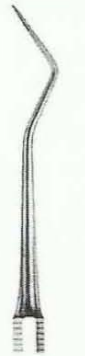

786-965/45



786-976/43

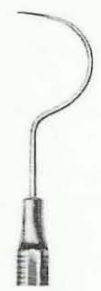

786-977/44



786-978/45

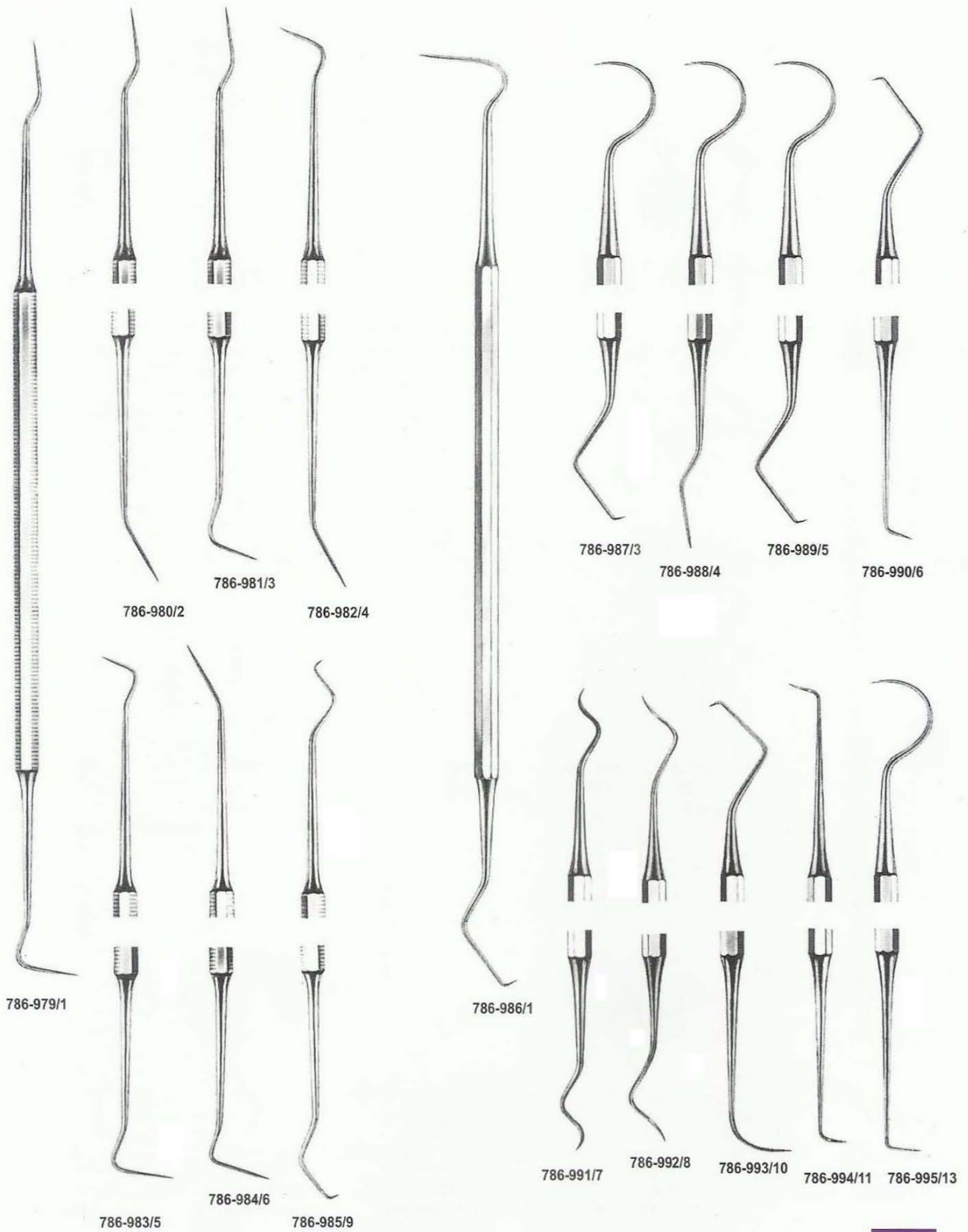



786-996
Williams



786-997
Williams



786-998
Merritt A



786-999
Merritt B

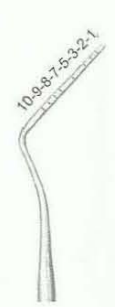

786-1000
Goldman
Fox



786-1001
University
of Michigan

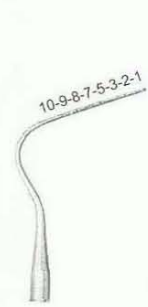

786-1002
26 G

color - coded



786-1003
CP-12S
O.M.S



786-1004
CP-11



786-1005
CP-12



786-1006
Fig.1
Luks



786-1007
Fig.2
Luks



786-1008
Fig.3
Luks



786-1009
Fig.4
Luks

Root-canal Pluggers

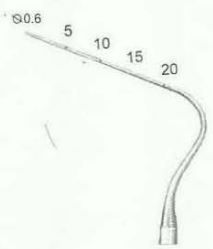

786-1010
Fig. 1
vertical condenser

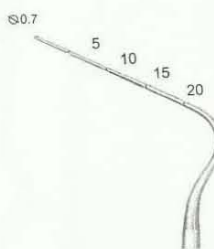

786-1011
Fig. 2
vertical condenser

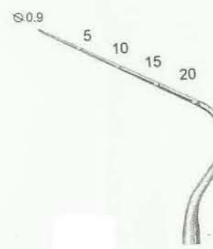

786-1012
Fig. 3
vertical condenser

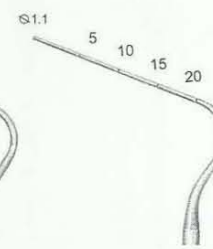

786-1013
Fig. 4
vertical condenser

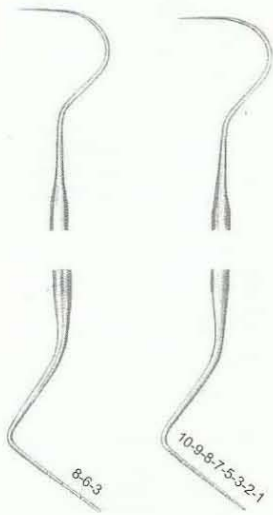

786-1015 UM
Fig.23
 University of Michigan

786-1016 W
Fig.23
 Williams

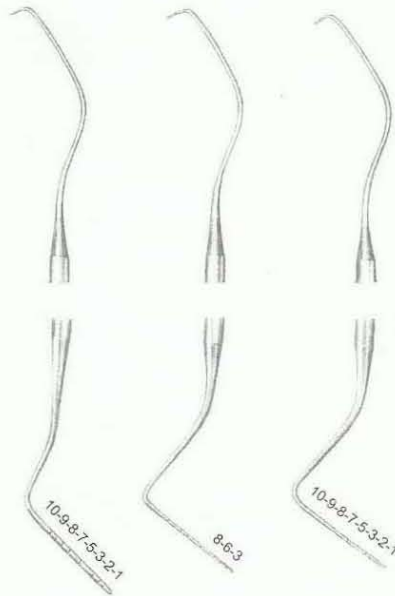

786-1017 GF
Fig.17
 Goldman-Fox

786-1018 UM
Fig.17
 University of Michigan

786-1019 W
Fig.17
 Williams

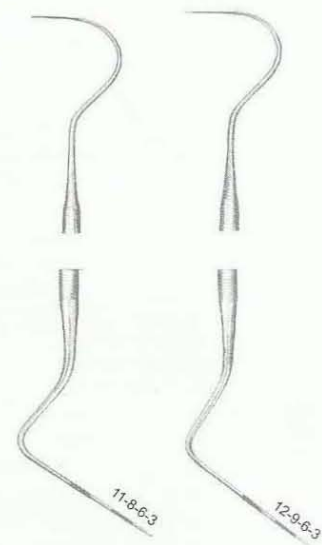

786-1020
Fig.23/CP11

786-1021
Fig.23/CP12



786-1014 GF
Fig.23
 Goldman-Fox

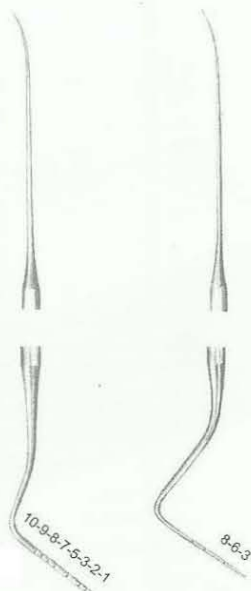

786-1022 GF
Fig.3
 Goldman-Fox

786-1023 UM
Fig.3
 University of Michigan

786-1024 W
Fig.3
 Williams

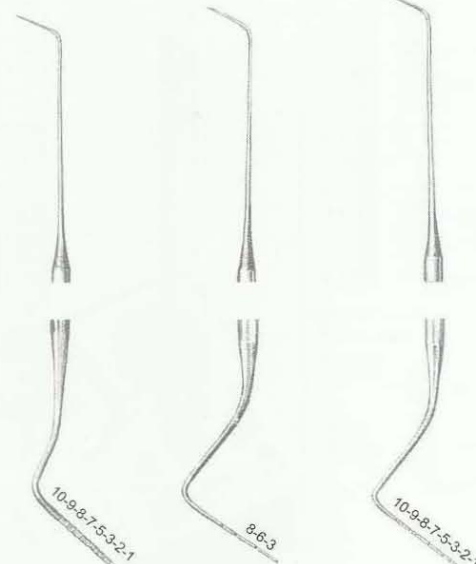

786-1025 GF
Fig.16
 Goldman-Fox

786-1026 UM
Fig.16
 University of Michigan

786-1027 W
Fig.16
 Williams

Explorers Set



New Hollow
 786-1028
 Fig.23



786-1029
 Fig.2



786-1030
 Fig.17A



786-1031
 Fig.3A



786-1032
 Fig.16



786-1033
 Fig.12



786-1034
 Fig.8



786-1035
 Fig.9



786-1036
 Williams

Endo Box

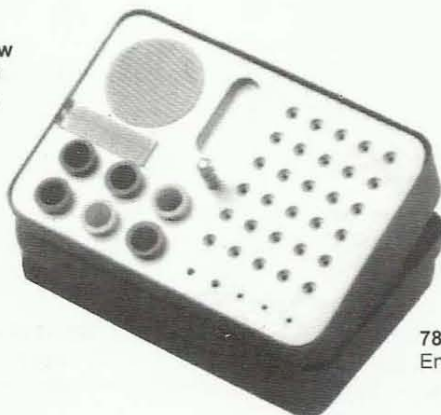

786-1037
 Endo Total

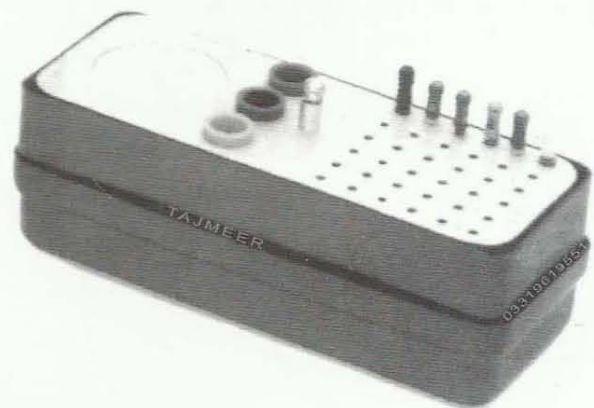

786-1038
 Endo Total Mini

Mouth mirrors
miroirs à bouche
Espejos de boca



hohl
magnifying
grossissant
cóncavos



Plan
plane
non-grossissant
planos

einfaches Gewinde
simple thread
filet simple
rosca sencilla

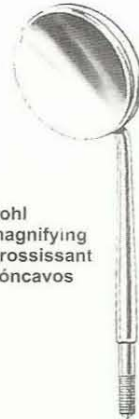

hohl
magnifying
grossissant
cóncavos

Plan
plane
non-grossissant
planos

mit Cone-socket
with cone-socket
à cone-socket
con cone-socket

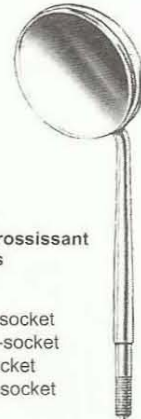

786-1039/3 - 20 mm Ø
786-1040/4 - 22 mm Ø
786-1041/5 - 24 mm Ø
786-1042/6 - 26 mm Ø

786-1043/3 - 20 mm Ø
786-1044/4 - 22 mm Ø
786-1045/5 - 24 mm Ø
786-1046/6 - 26 mm Ø

786-1047/3 - 20 mm Ø
786-1048/4 - 22 mm Ø
786-1049/5 - 24 mm Ø
786-1050/6 - 26 mm Ø

786-1051/3 - 20 mm Ø
786-1052/4 - 22 mm Ø
786-1053/5 - 24 mm Ø
786-1054/6 - 26 mm Ø

Mouth mirrors - Miroirs à bouche
Espejos de boca
Handles for mouth mirrors - Manches pour
miroirs à bouche - Mangos para espejos de boca

RHODIUM MOUTH MIRRORS ARE ALSO AVAILABLE WITH SAME SPECIFICATIONS AS ABOVE

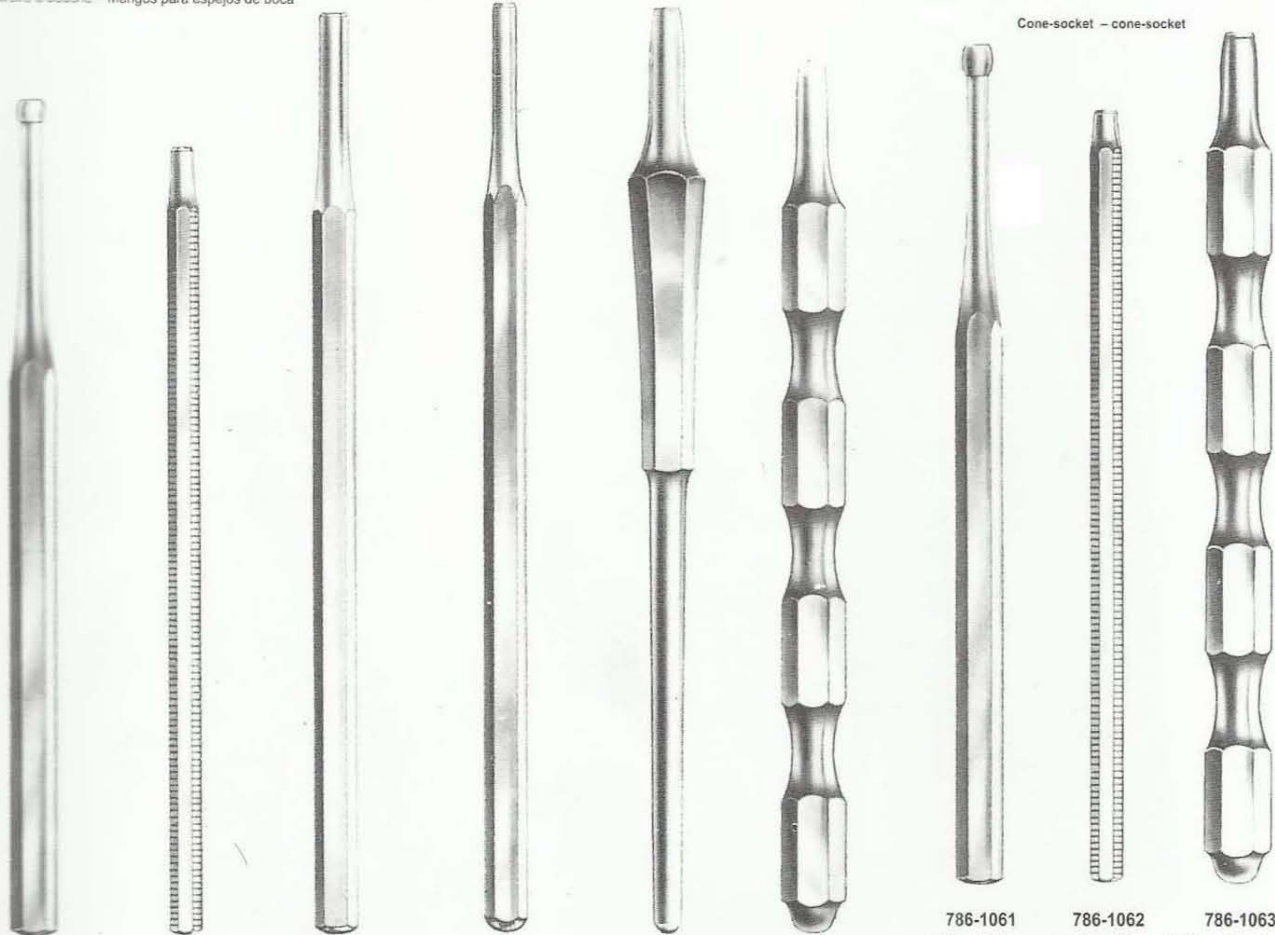

786-1055

786-1056

786-1057

786-1058

786-1059

786-1060

786-1061

786-1062

786-1063

hohl rostfrei
hollow stainless
creux inoxydable
hueco inoxidable

massiv rostfrei
solid stainless
massif inoxydable
sólido inoxidable

hohl verchromt
hollow chromium plated
creux chromé
hueco cromado

einfaches Gewinde (M 2,6) - simple thread - filet simple - rosca sencilla
786-1055 hohl verchromt - hollow chromium plated - creux chromé - hueco cromado
786-1056 massiv rostfrei - solid stainless - massif inoxydable - sólido inoxidable
786-1057 hohl rostfrei - hollow stainless - creux inoxydable - hueco inoxidable
786-1058 hohl rostfrei - hollow stainless - creux inoxydable - hueco inoxidable
786-1059 hohl rostfrei - hollow stainless - creux inoxydable - hueco inoxidable
786-1060 hohl rostfrei - hollow stainless - creux inoxydable - hueco inoxidable



RESTORATIVE





Molar Clamps Winged



786-1064
Fig. 30



786-1065
Fig. 31



786-1066
Fig. 51



786-1067
Fig. 138



786-1068
Fig. 139



786-1069
Fig. 15



786-1070
Fig. 18



786-1071
Fig. 24



786-1072
Fig. 25



786-1073
Fig. 26



786-1074
Fig. 28

Bicuspid Clamps Winged



786-1075
Fig. 206



786-1076
Fig. 207



786-1077
Fig. 208



786-1078
Fig. 209



786-1079
Fig. 22



786-1080
Fig. 27



786-1081
Fig. 29

Molar Clamps Winged

Bicuspid Clamps Winged



786-1082
Fig. 26A



786-1083
Fig. 28A



786-1084
Fig. 30A



786-1085
Fig. 31A



786-1086
Fig. 51A



786-1087
Fig. 27



786-1088
Fig. 29



786-1089
Fig. 60

Molar Clamps Winged



786-1090
Fig. 200



786-1091
Fig. 201



786-1092
Fig. 202



786-1093
Fig. 203



786-1094
Fig. 204



786-1095
Fig. 205

Labial Clamps Winged



786-1096
Fig. 210

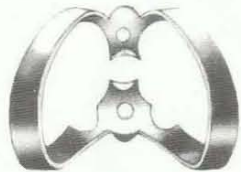

786-1097
Fig. 211



786-1098
Fig. 212

Rubber-Dam punch - perforateur à digue
 Perforador para dique de caucho
 Rubber-Dam clamp forceps-pinces porte-crampons à digue
 Pinzas de engrapar para dique de caucho

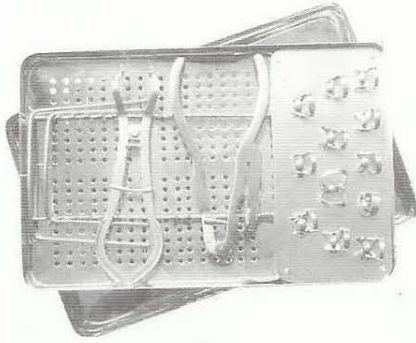

786-1100-K
 Rubber Dam Kit

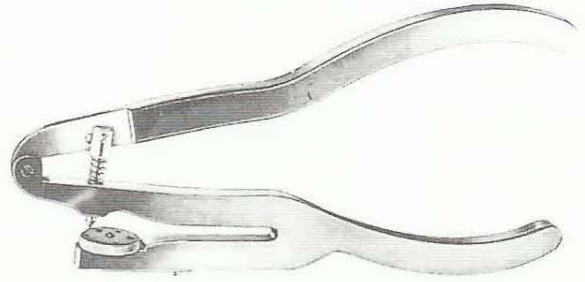

786-1101
 Ivory

mit einer Lochreihe
 with 1 row of holes
 avec 1 rangée de trous
 con una serie de agujeros

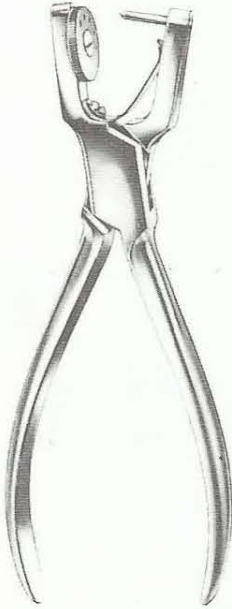
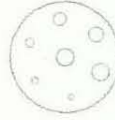

786-1099



786-1100

Ainsworth

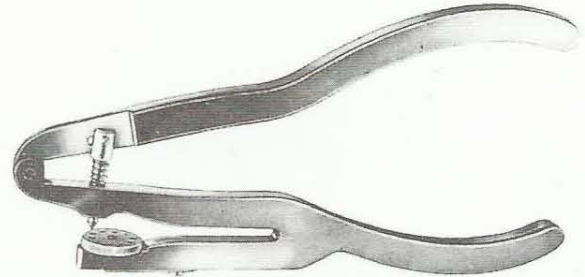

786-1102
 Ivory

mit 2 Lochreihen
 with 2 rows of holes
 avec 2 rangées de trous
 con 2 series de agujeros

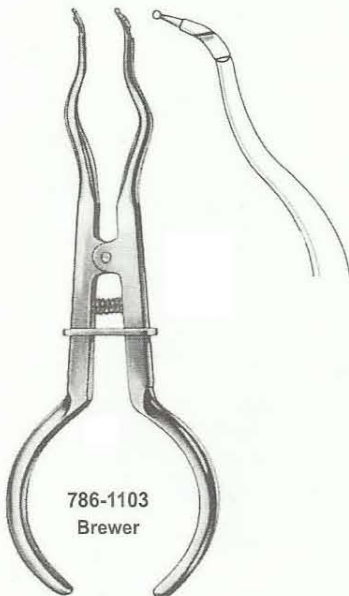
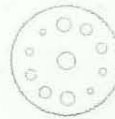

786-1103
 Brewer

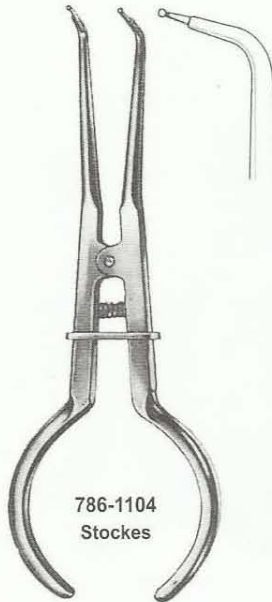

786-1104
 Stokes

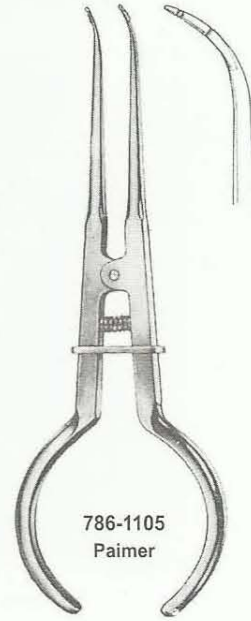

786-1105
 Paimer

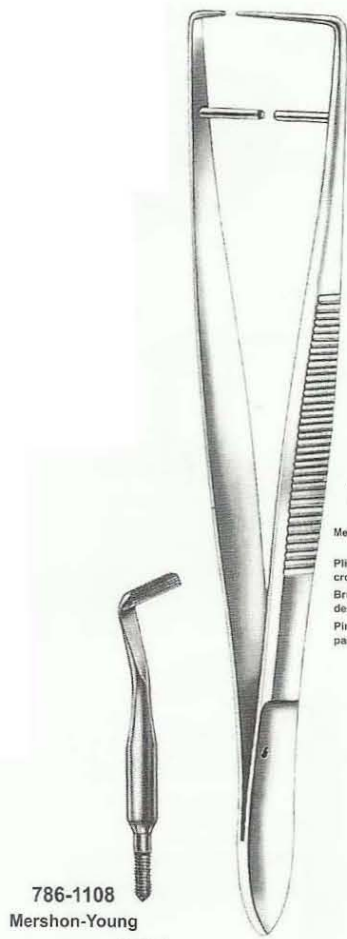

786-1108
 Mershon-Young



786-1107
 Mershon-Young

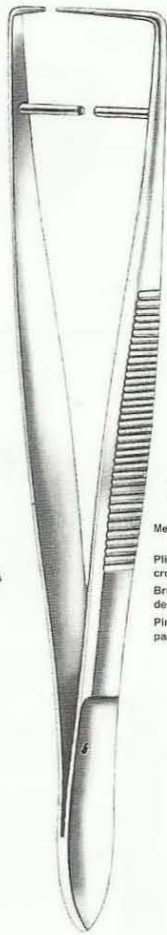

786-1109
 Meßpinzette für Kronen
 Pliers for measuring
 crowns
 Brucelles de mesure
 des couronnes
 Pinzas de medida
 para coronas



786-1106
 Mershon



786-1110
 Miller

Artikulationspapier-
 Pinzette
 Forceps for
 Articulating Paper
 Pince pour papier
 à articuler
 Pinza para papel de
 articular



786-1111

Bandaufsetzer
 mit Zinnaufiage
 Band Setter,
 with tin insert
 Adaptateur de rubans,
 garni de étain
 Empujador para bandas,
 cubierto de estaño



786-1112
 Steiner

Band Driver
 Adapteurs pour rubans
 Ajustador de bandas

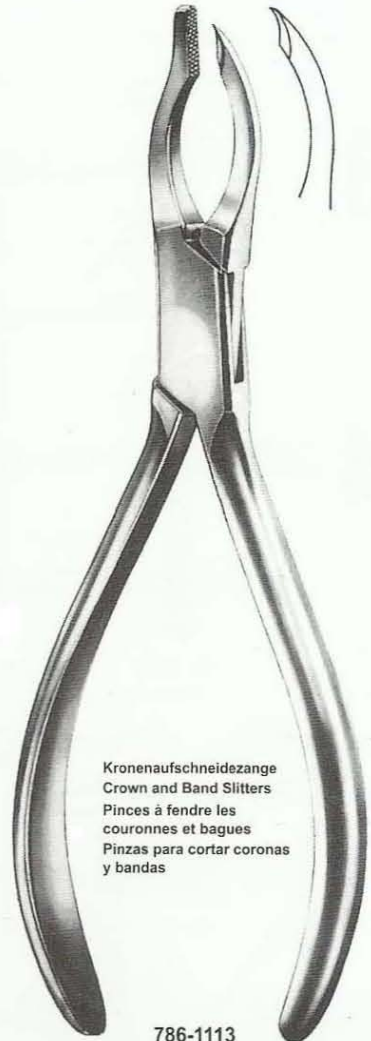

Kronenaufschneidezange
 Crown and Band Slitters
 Pincés à fendre les
 couronnes et bagues
 Pinzas para cortar coronas
 y bandas

786-1113
 Bandtreiber



786-1114
 Rubber Dam Frame

Amalgam Carriers

Ø1,5 mm



786-1115
Small

Ø2 mm



786-1116
Medium

Ø2,5 mm



786-1117
Large

Ø3 mm



786-1118
Jumbo



786-1119
Amalgam well

Amalgam Finger Cup



786-1120



786-1121

Ø2 mm



786-1122
Medium /Small

Ø2 mm



786-1123
Medium /Large

Ø2 mm



786-1124
Medium /Jumbo

Ø1,5 mm

786-1122
Medium /Small

Ø2,5 mm

786-1123
Medium /Large

Ø3 mm

786-1124
Medium /Jumbo

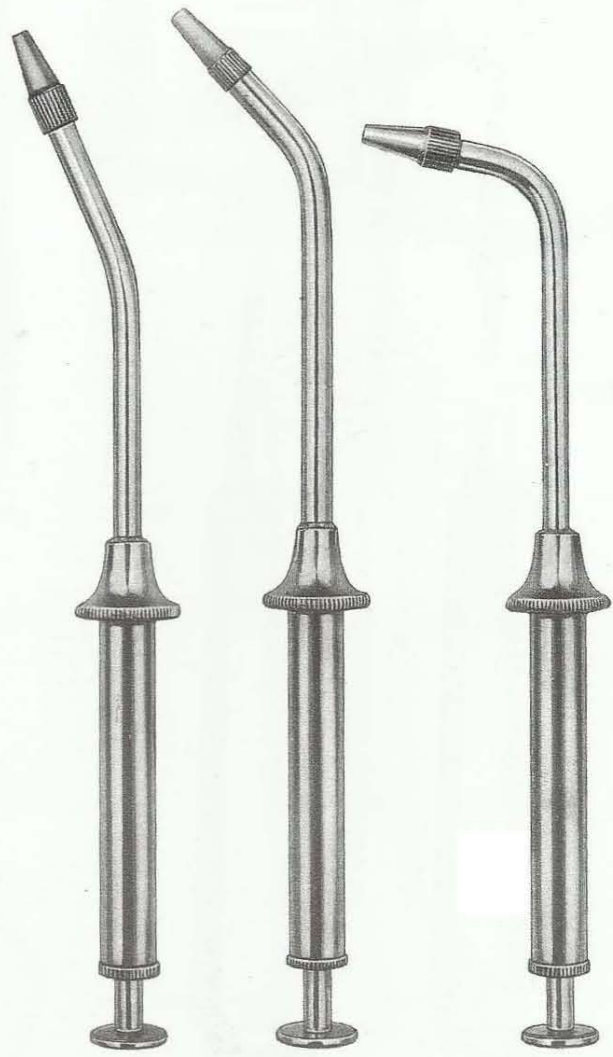

786-1125

786-1126

786-1127

Heidemann Separating Spatulas

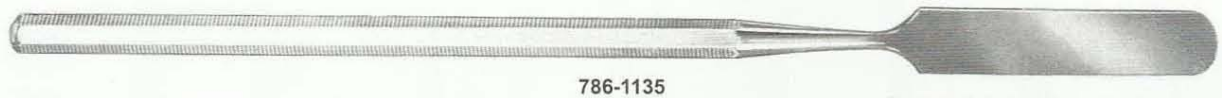
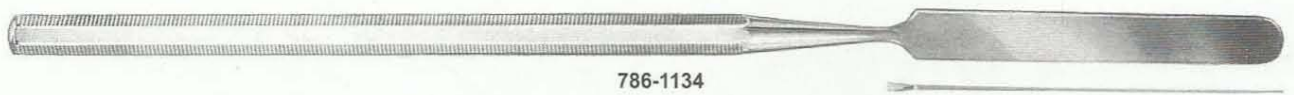
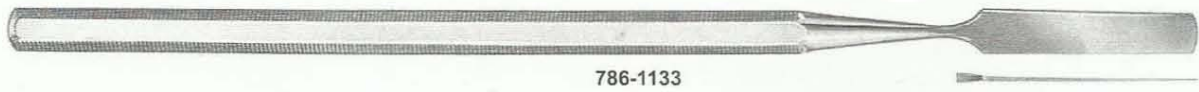
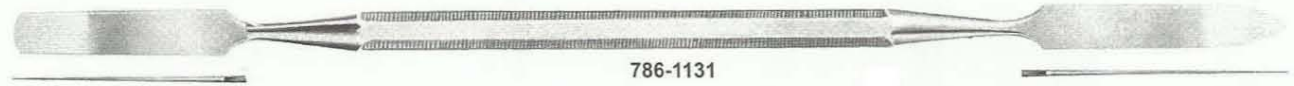
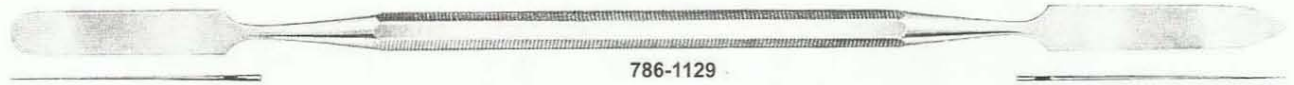
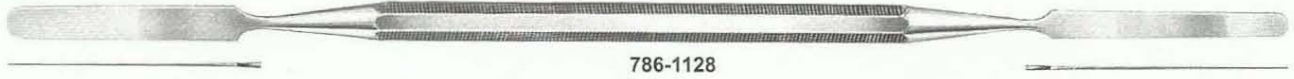

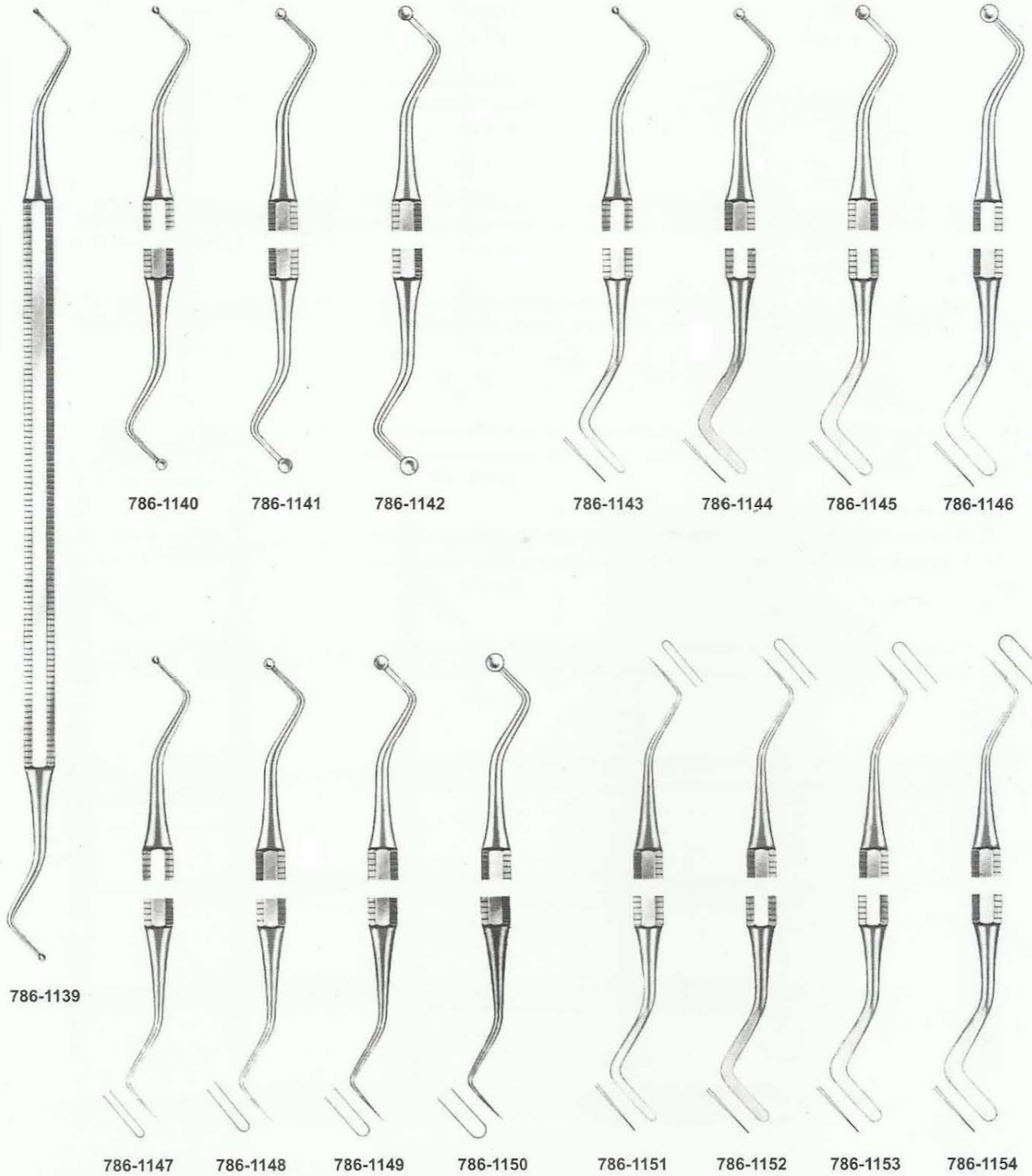



786-1155



786-1156

786-1157

786-1158

786-1159

786-1160

786-1161

786-1162

786-1163

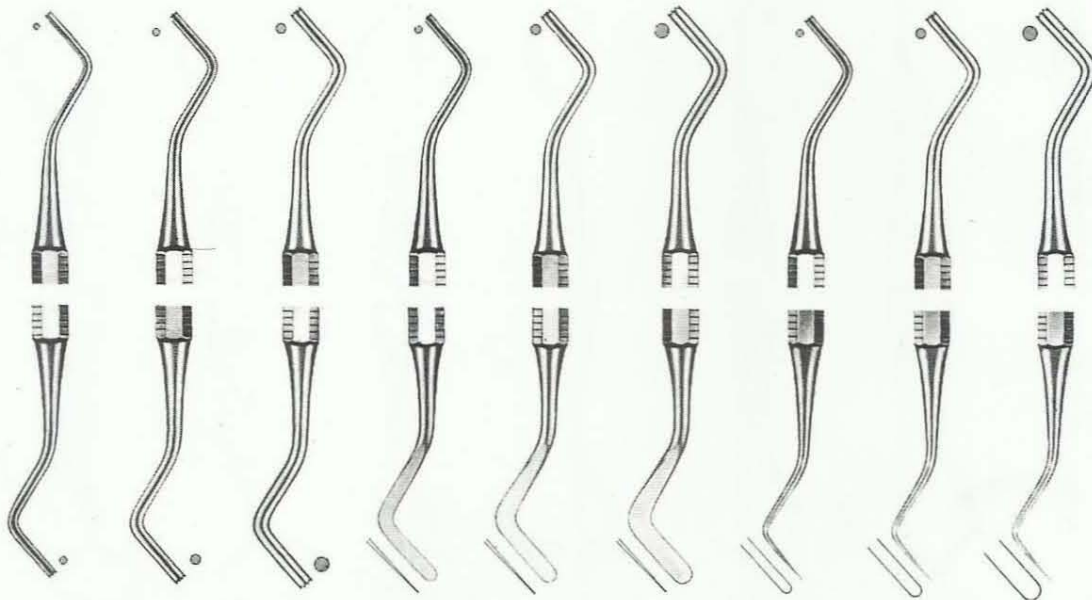

786-1164

786-1165

786-1166

786-1167

786-1168

786-1169

786-1170

786-1171

786-1172

Filling instruments
 Instruments pour plombage
 Instrumentos para obturaciones





786-1189

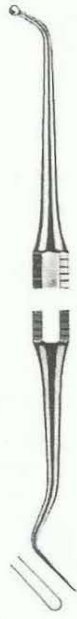

786-1190

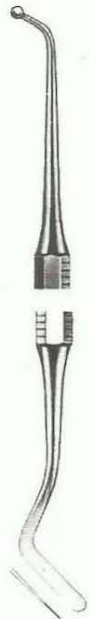

786-1191



786-1192

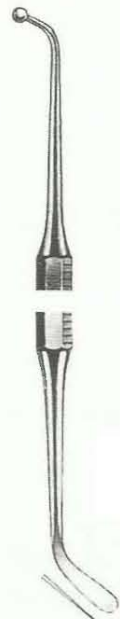

786-1193

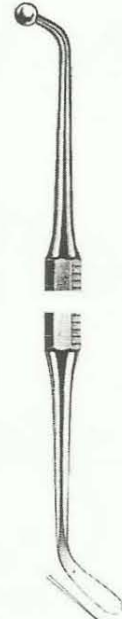

786-1194

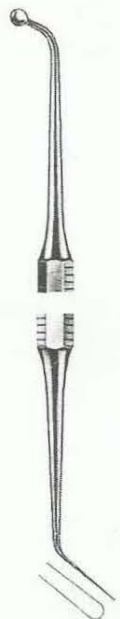

786-1195

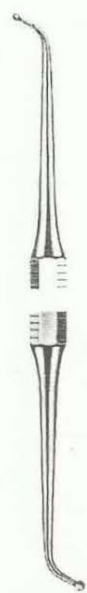

786-1196

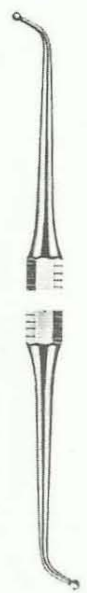

786-1197



786-1198

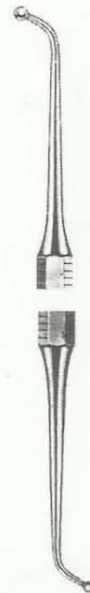

786-1199



786-1200



786-1201



786-1202





786-1203



786-1204



786-1205



786-1206



786-1207



786-1208



786-1209



786-1210



786-1211



786-1212

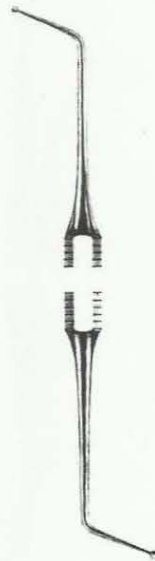

786-1213

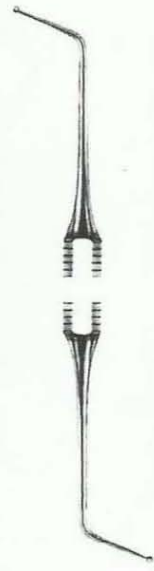

786-1214

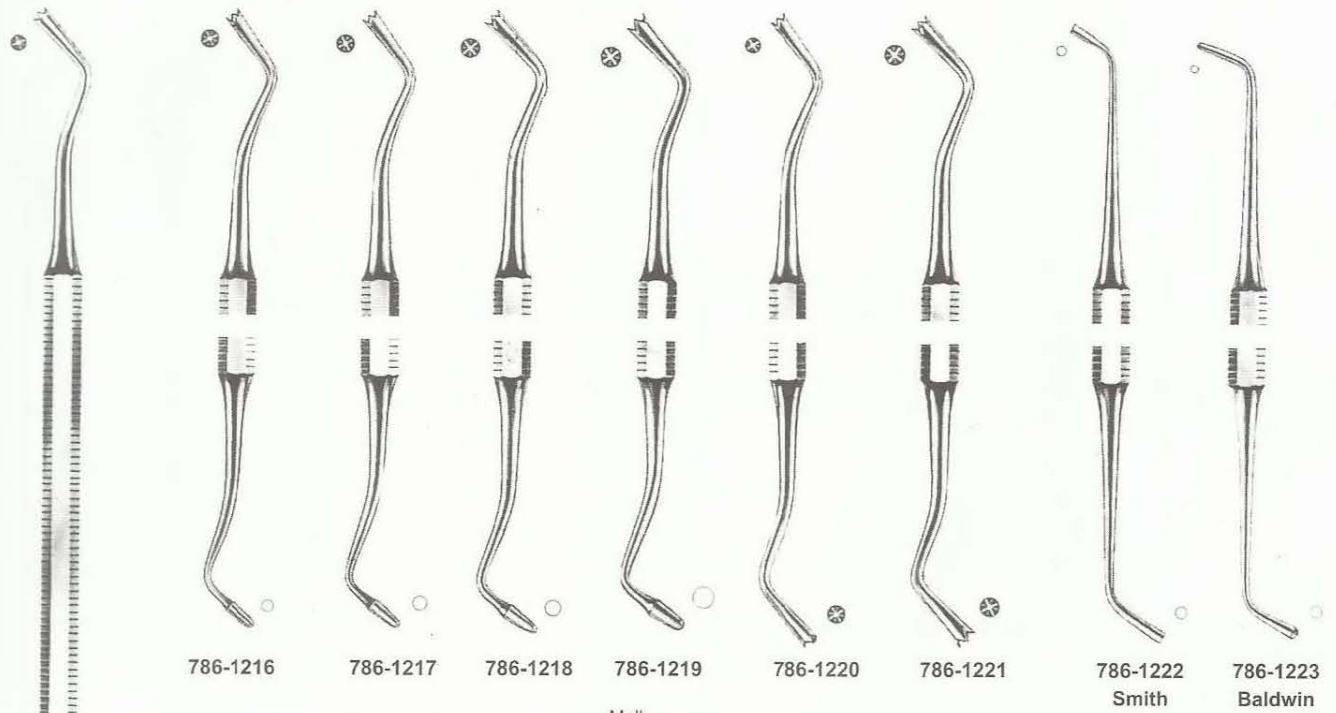

Mall

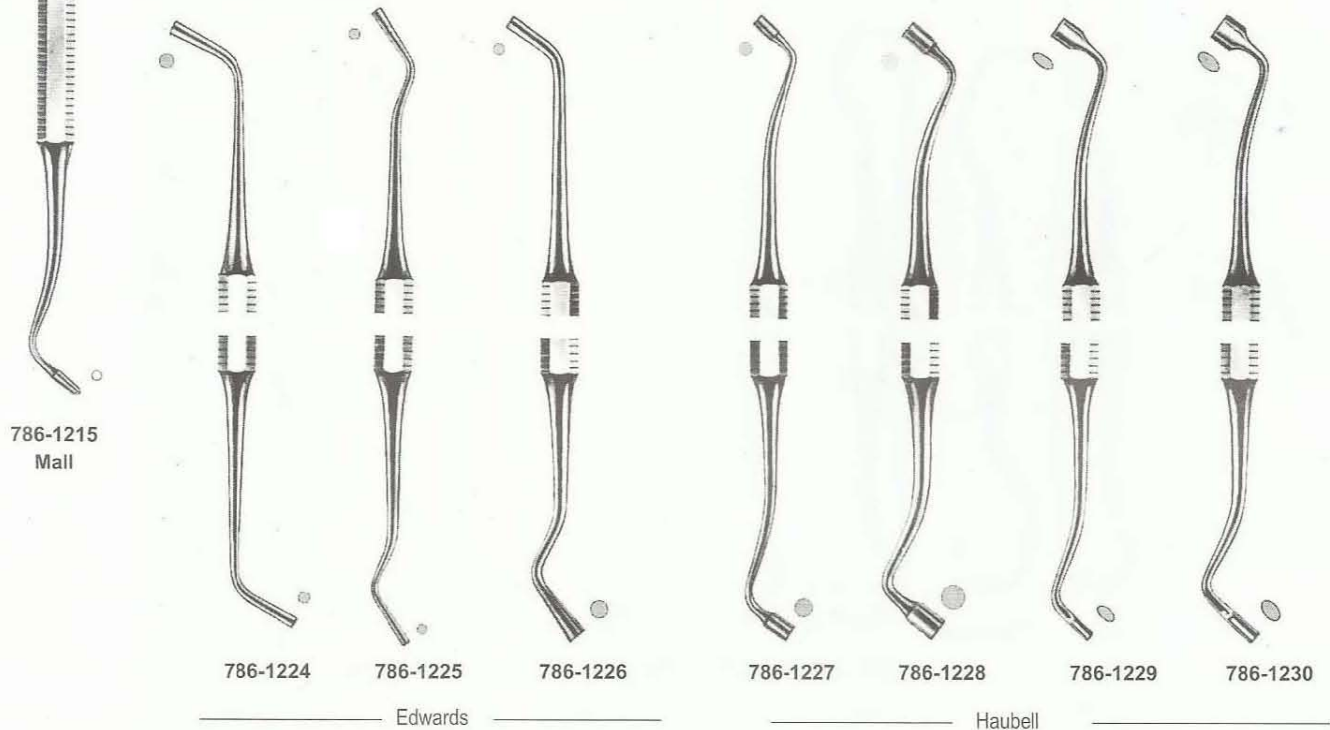

786-1215
Mall

Filling instruments
 Instruments pour plombage
 Instrumentos para obturaciones

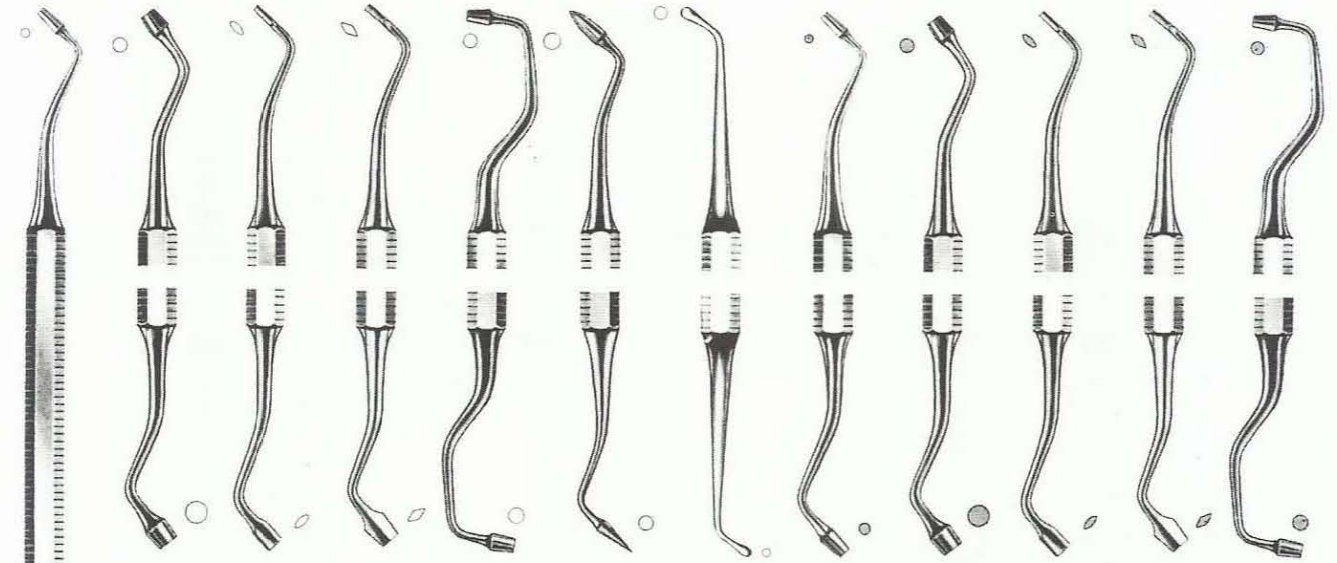

786-1232 786-1233 786-1234 786-1235 786-1236 786-1237 786-1238 786-1239 786-1240 786-1241 786-1242

Hollenback

Hollenback



786-1231
 Hollenback

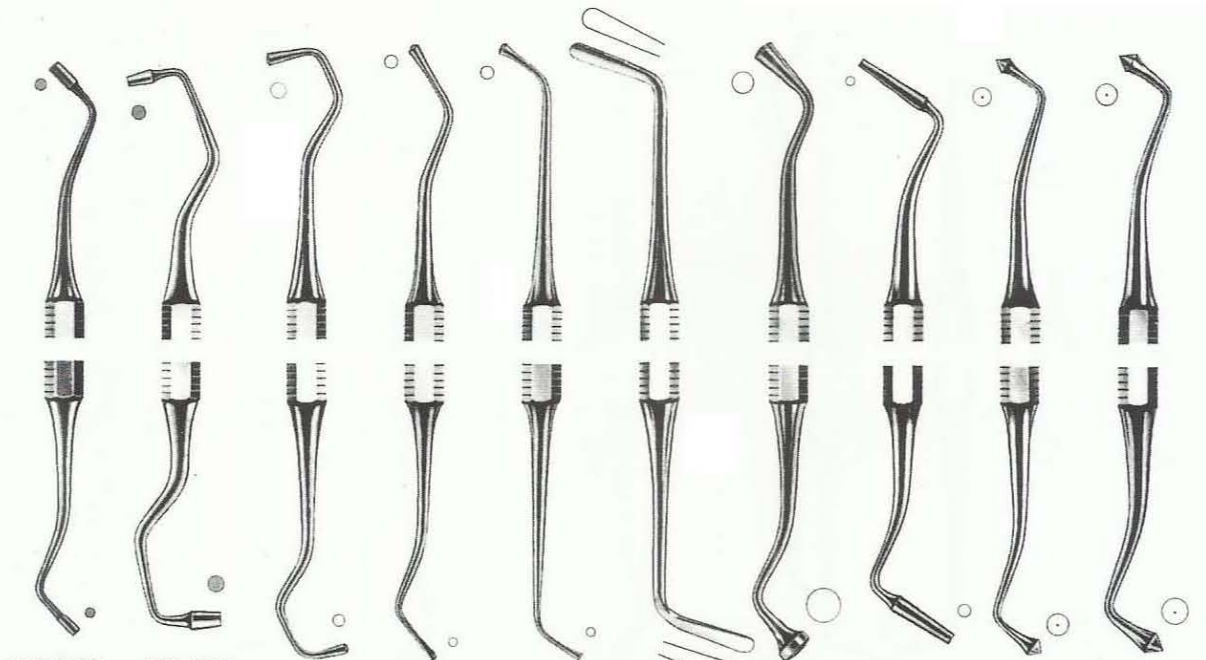

786-1243 786-1244 786-1245 786-1246 786-1247 786-1248 786-1249 786-1250 786-1251 786-1252

Ladmore

Mortonson

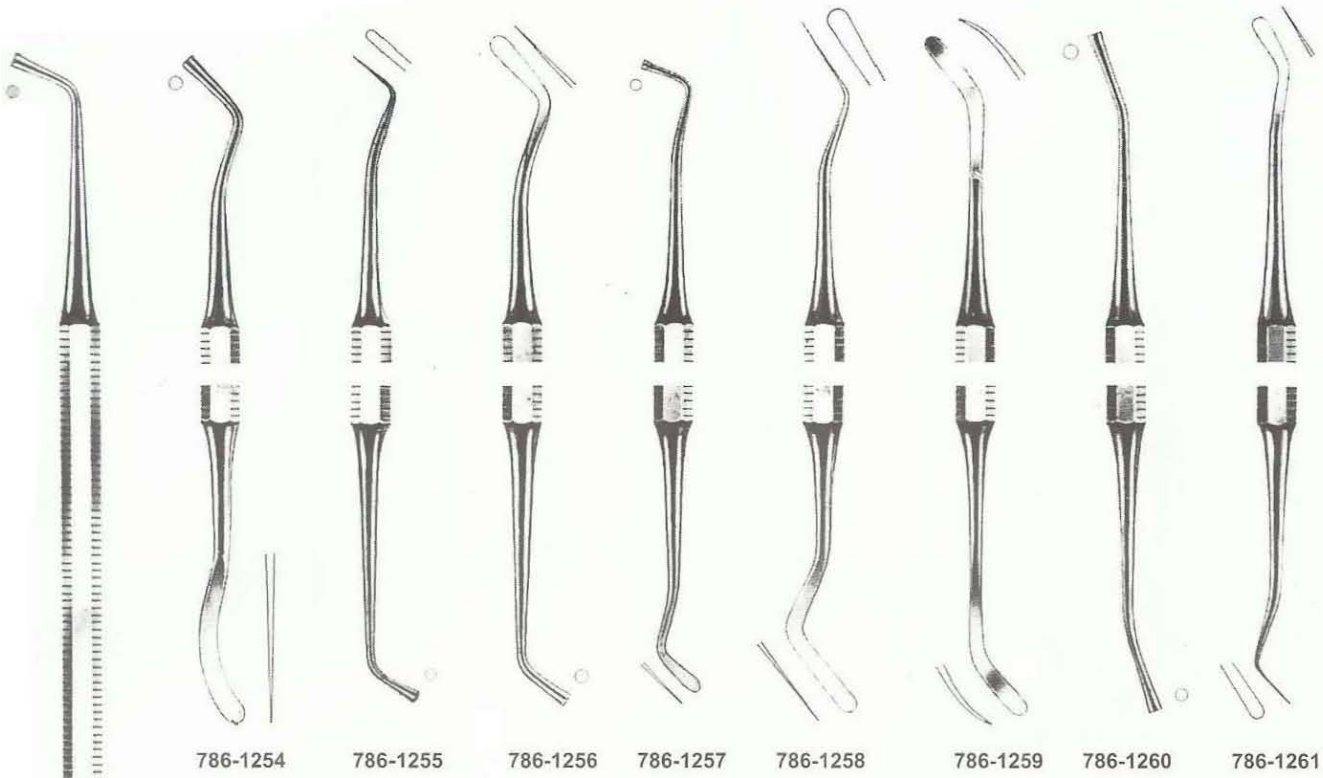

786-1254 786-1255 786-1256 786-1257 786-1258 786-1259 786-1260 786-1261

White

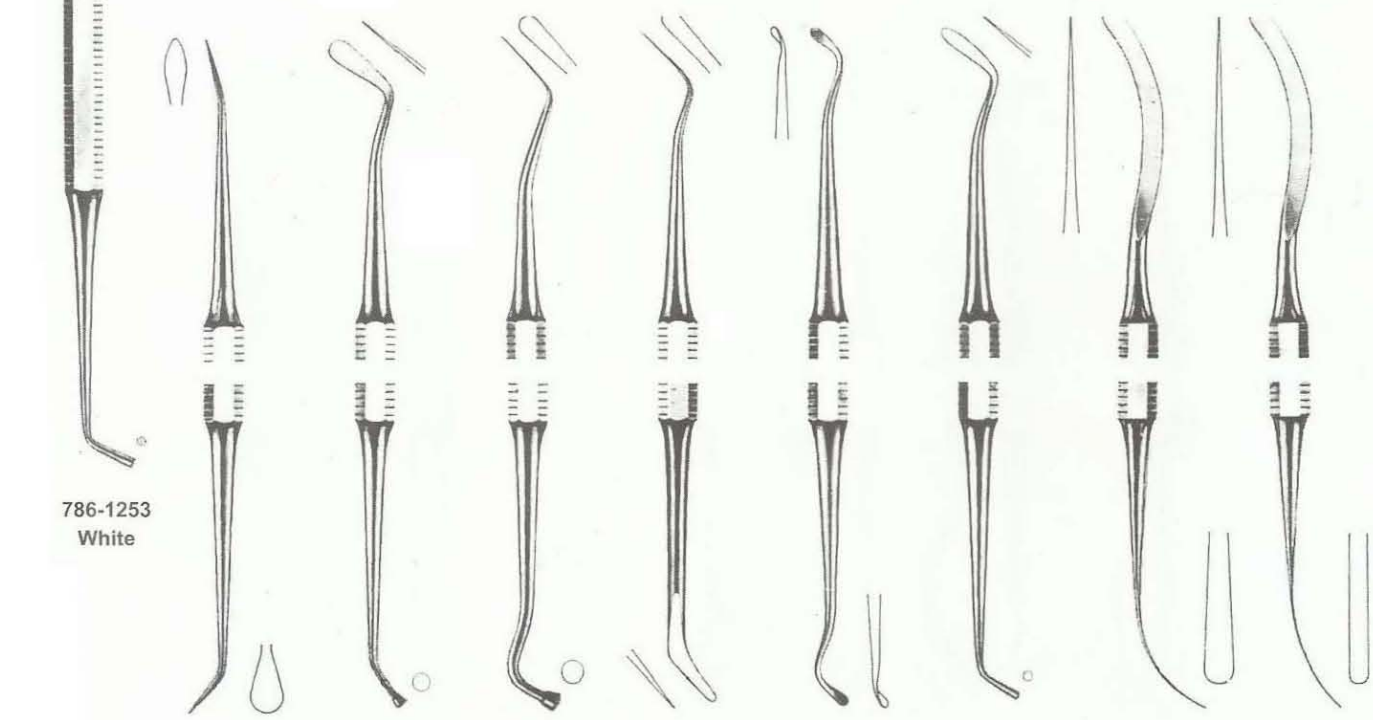

786-1253
 White

786-1262 786-1263 786-1264 786-1265 786-1266 786-1267 786-1268 786-1269

Moesle Moesle

Woodson

White

Filling instruments
 Instruments pour plombage
 Instrumentos para obturaciones

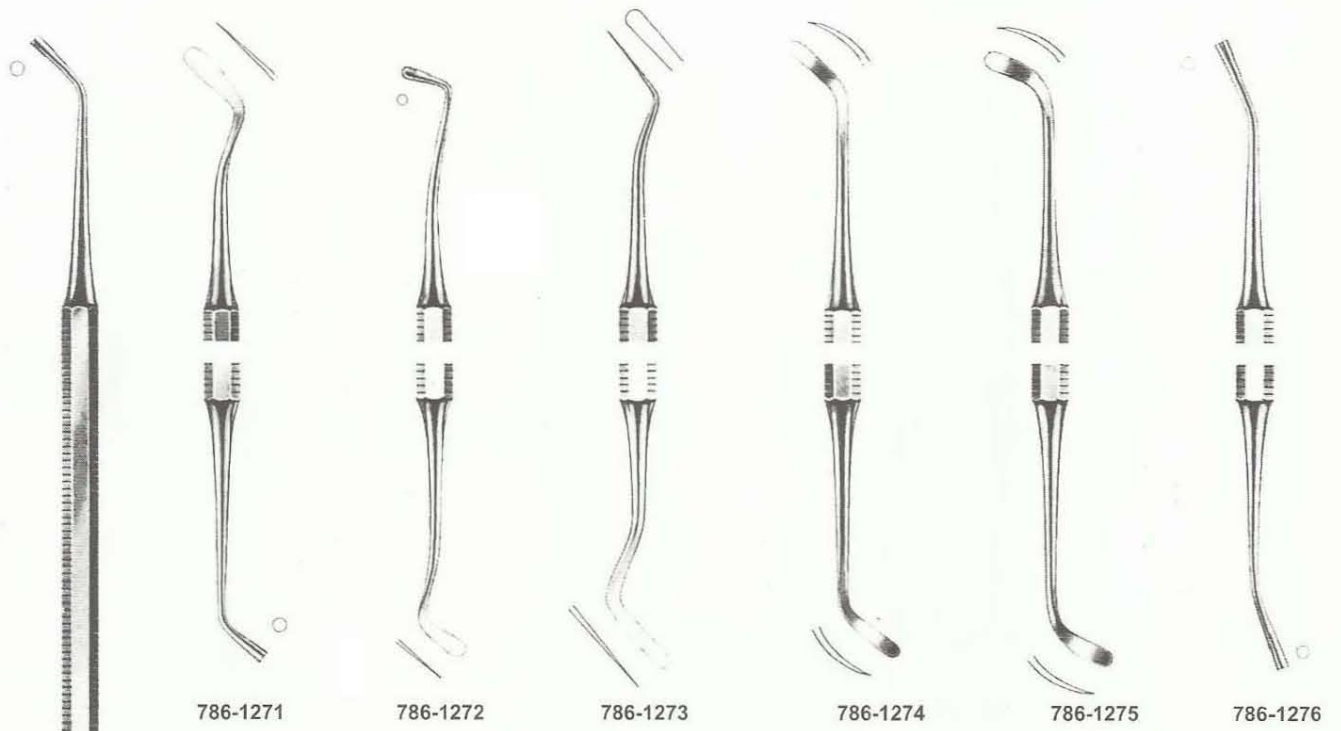

White

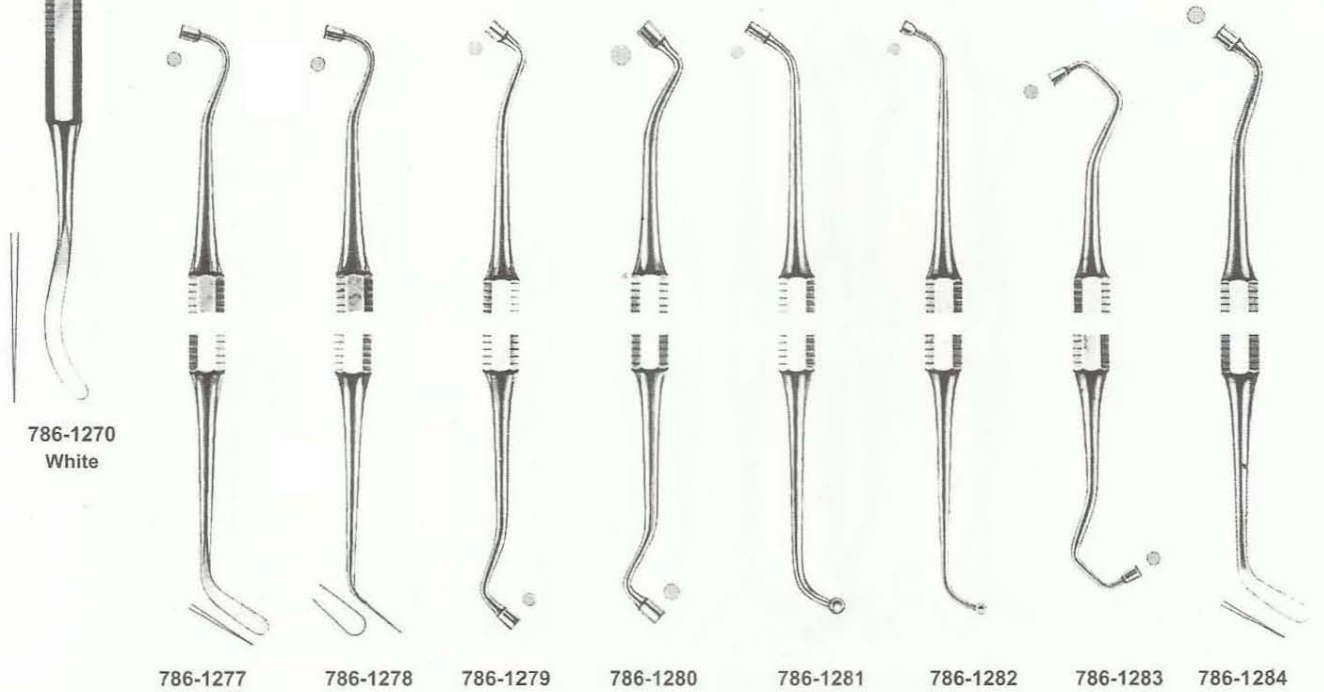

Biber

786-1270
 White

Filling instruments
 Instruments pour plombage
 Instrumentos para obturaciones

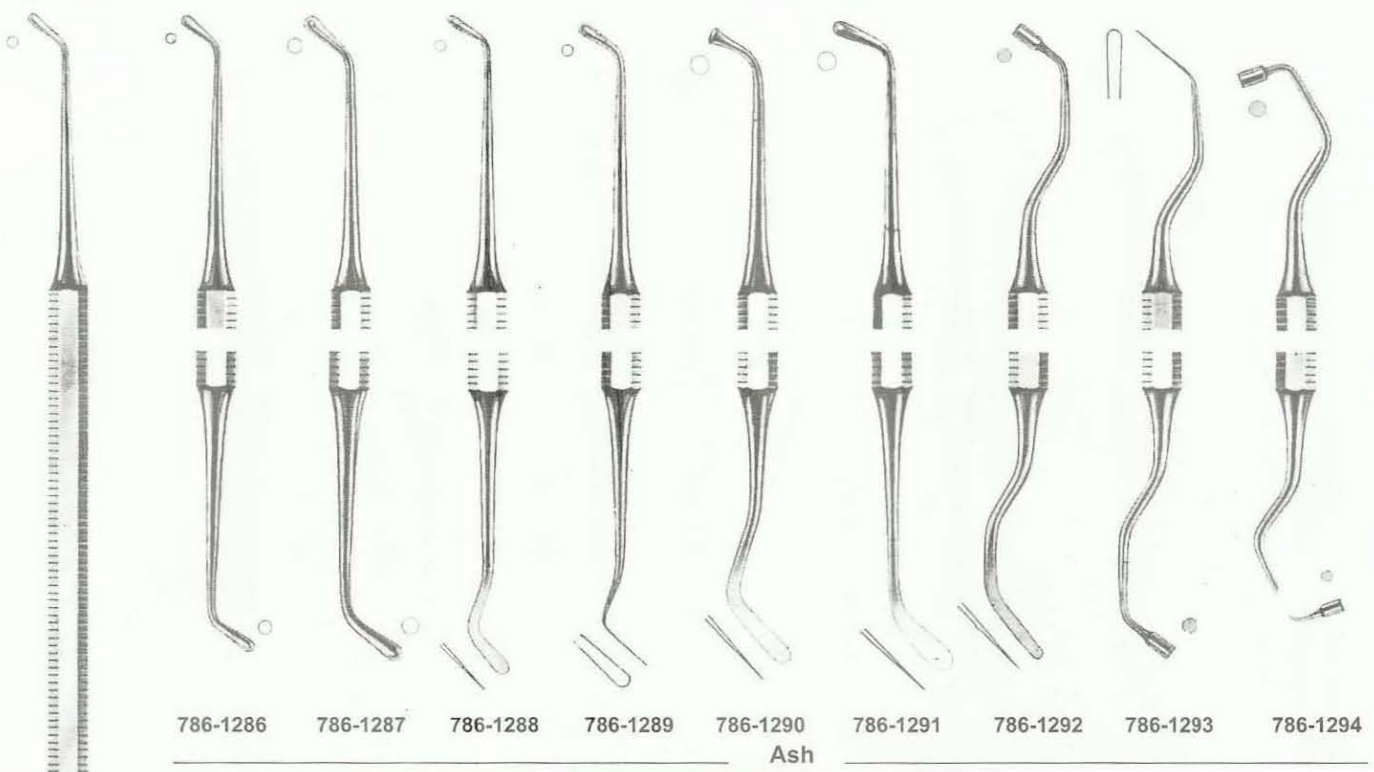

786-1285
 Ash

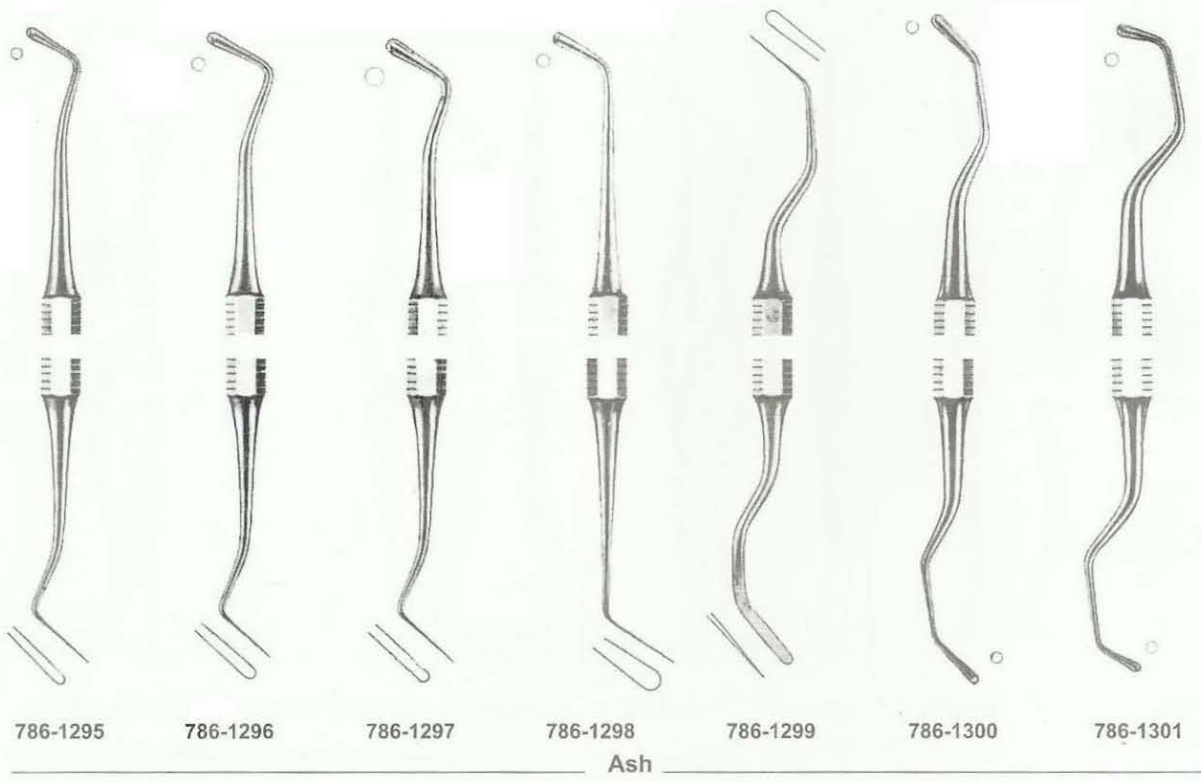

Filling instruments
 Instruments pour plombage
 Instrumentos para obturaciones

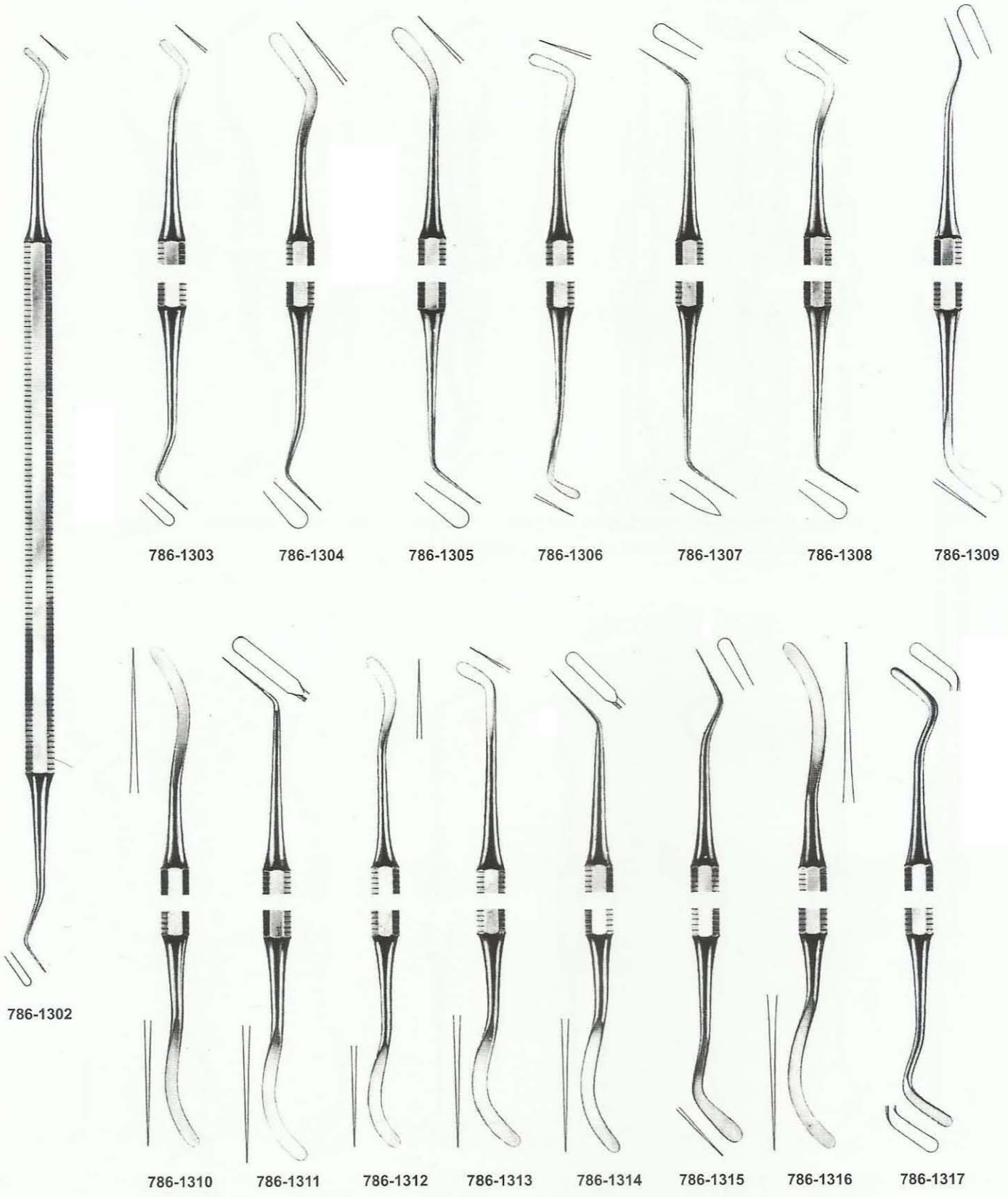

Linseman



786-1318 786-1319 786-1320 786-1321 786-1322 786-1323 786-1324 786-1325 786-1326

Williams

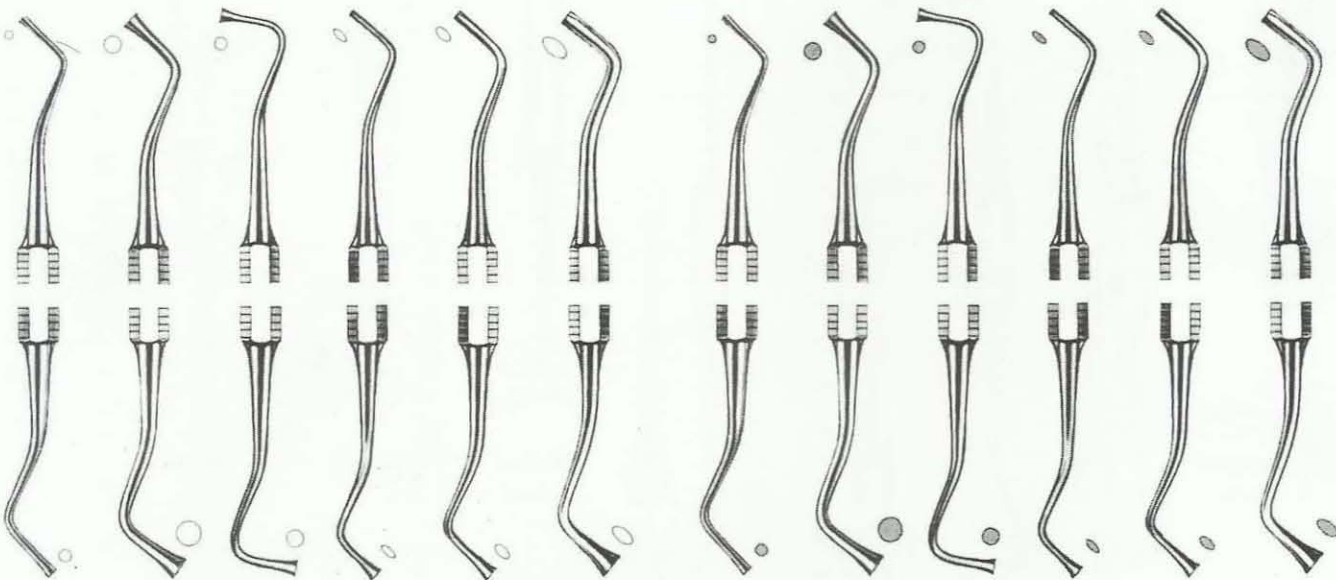

786-1327 786-1328 786-1329 786-1330 786-1331 786-1332 786-1333 786-1334 786-1335 786-1336 786-1337 786-1338

Ward

Ward

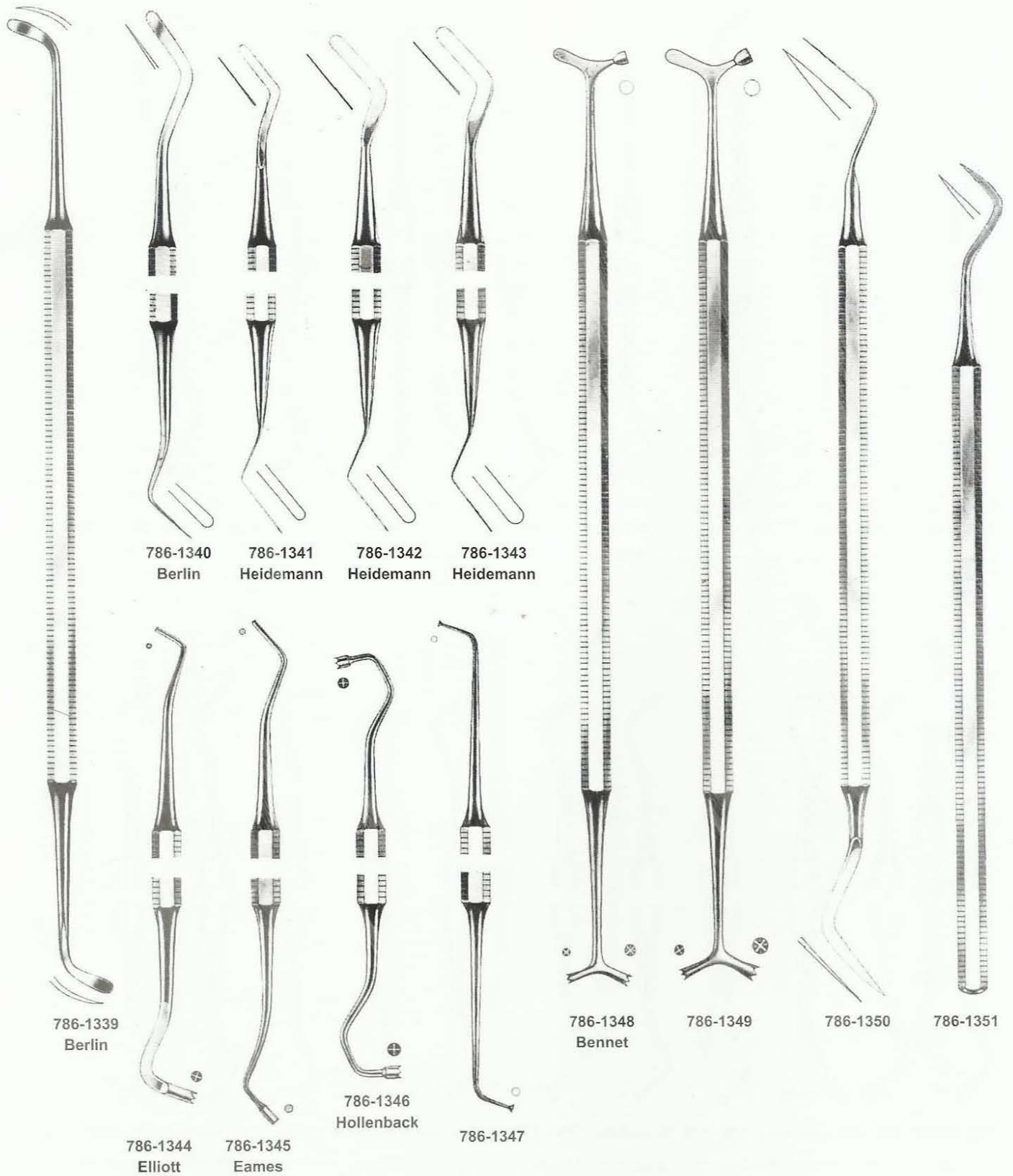



786-1352
 Black

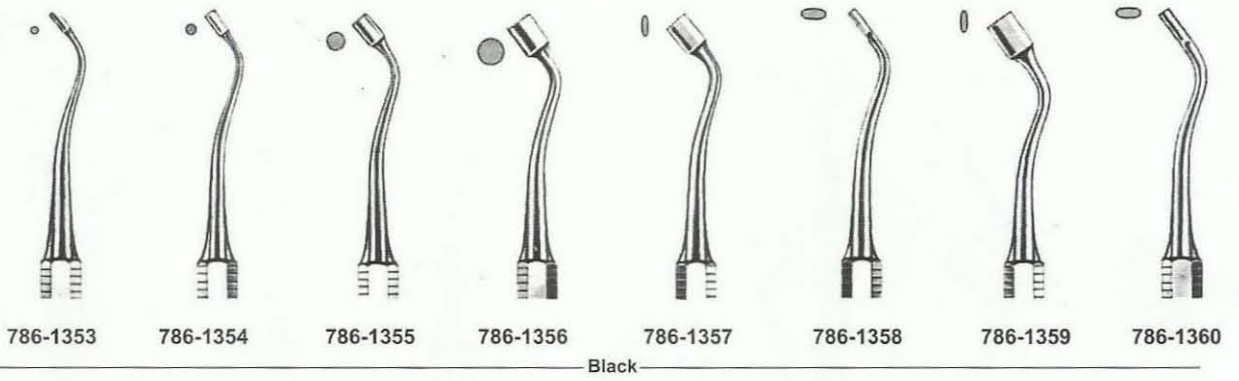

Black

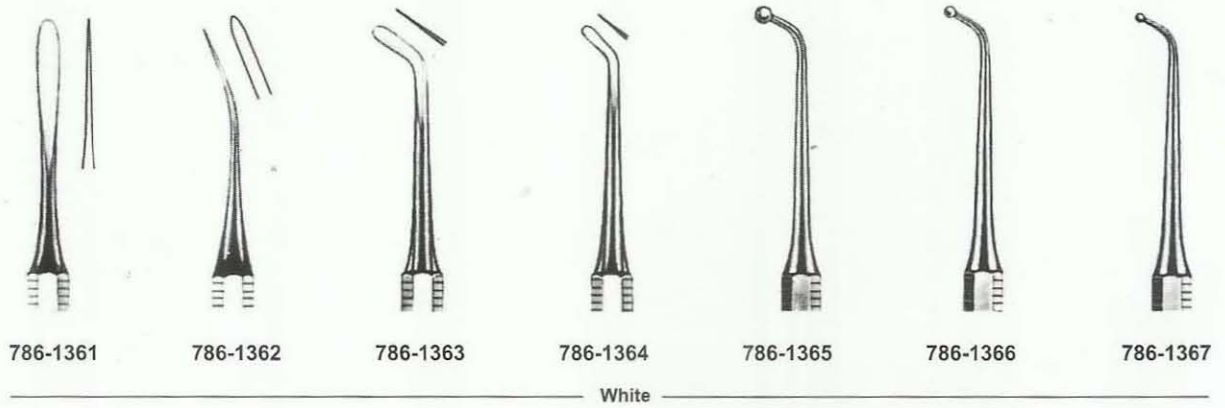

White

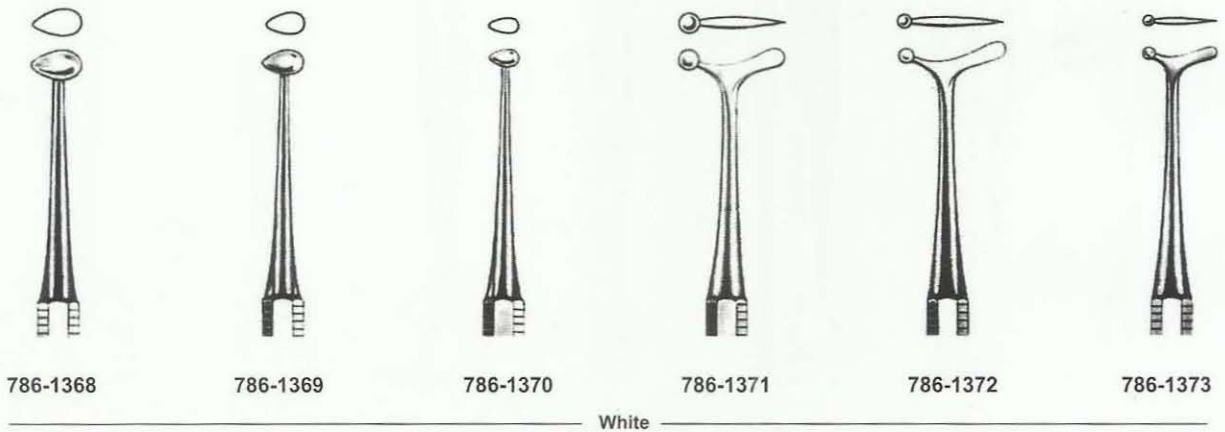

White

Polierinstrumente - Burnishers - Brunissoirs - Bruñidores

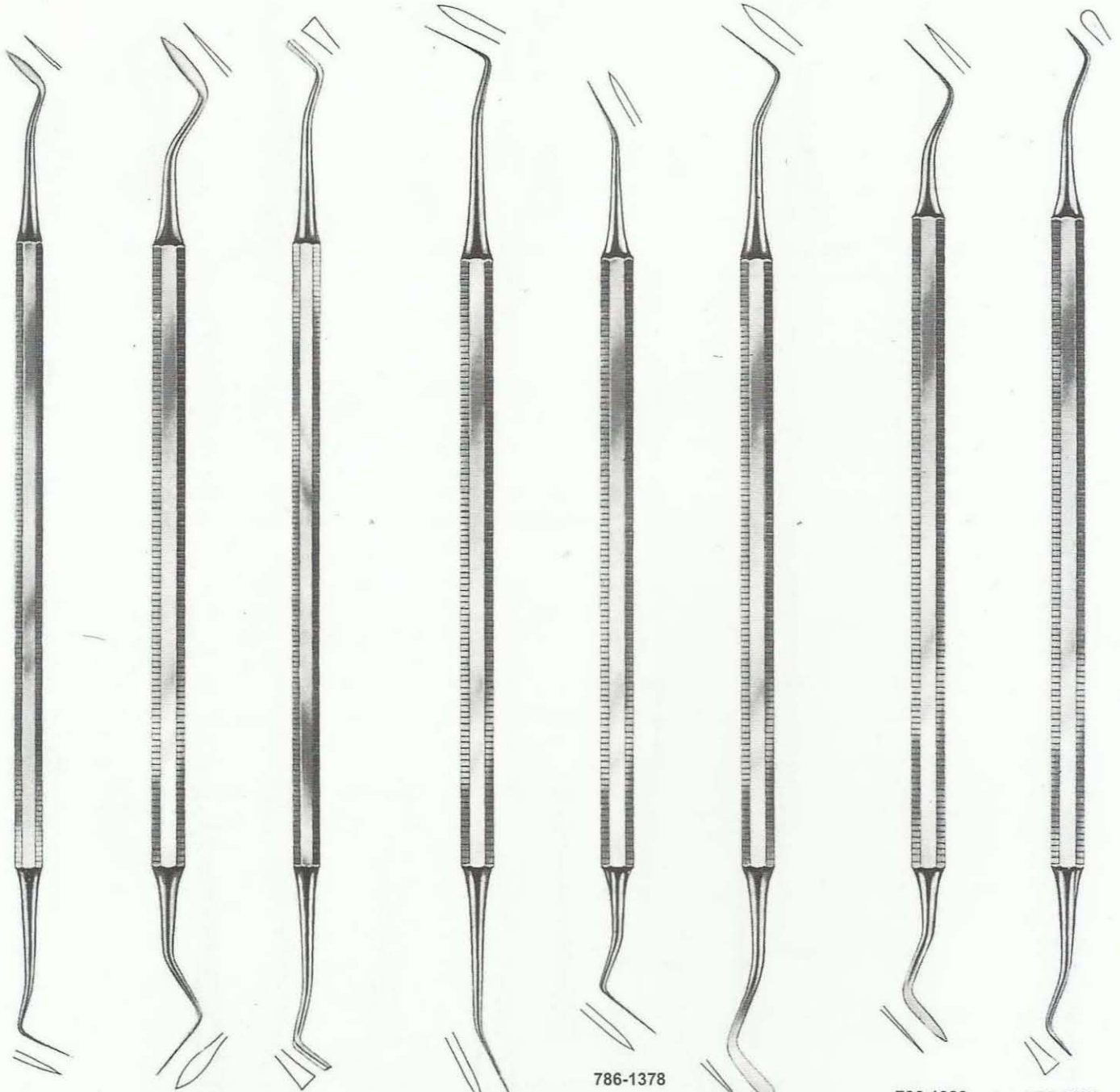

786-1374

786-1375

786-1376

786-1377

786-1378

786-1379

786-1380

786-1381

Hollenback

Ward

Wall



786-1382
Ward

786-1383

786-1384

786-1385

786-1386

786-1387

786-1388

786-1389

Tuft

Frahm

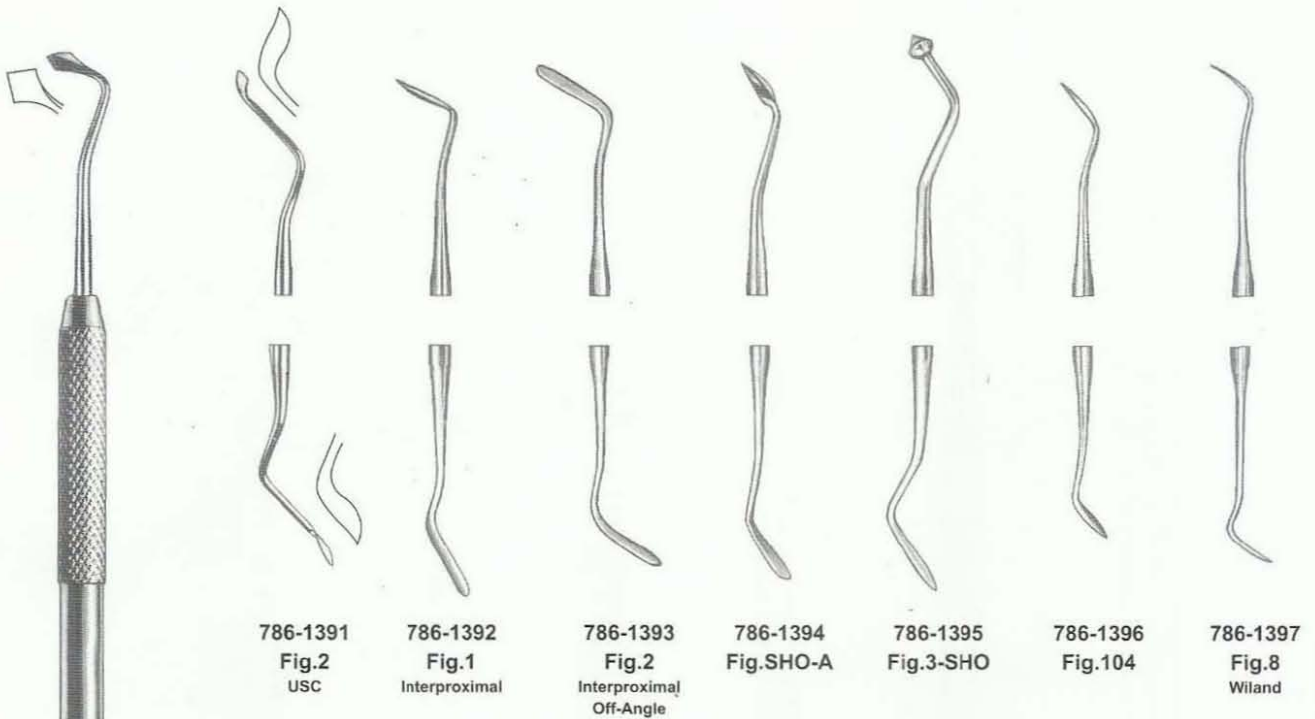

786-1391
Fig.2
USC

786-1392
Fig.1
Interproximal

786-1393
Fig.2
Interproximal
Off-Angle

786-1394
Fig.SHO-A

786-1395
Fig.3-SHO

786-1396
Fig.104

786-1397
Fig.8
Wiland

786-1390
Fig.1
Farhm

786-1398
Fig.1

786-1399
Fig.2

786-1400
Fig.3

786-1401
Fig.4

cleoids-discoids

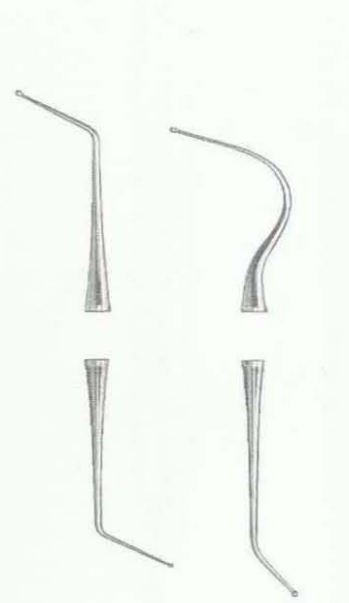

786-1403

786-1404

instrument for subgingival application
of tinctures and medicaments

786-1402



GINGIVAL MARGIN TRIMMERS

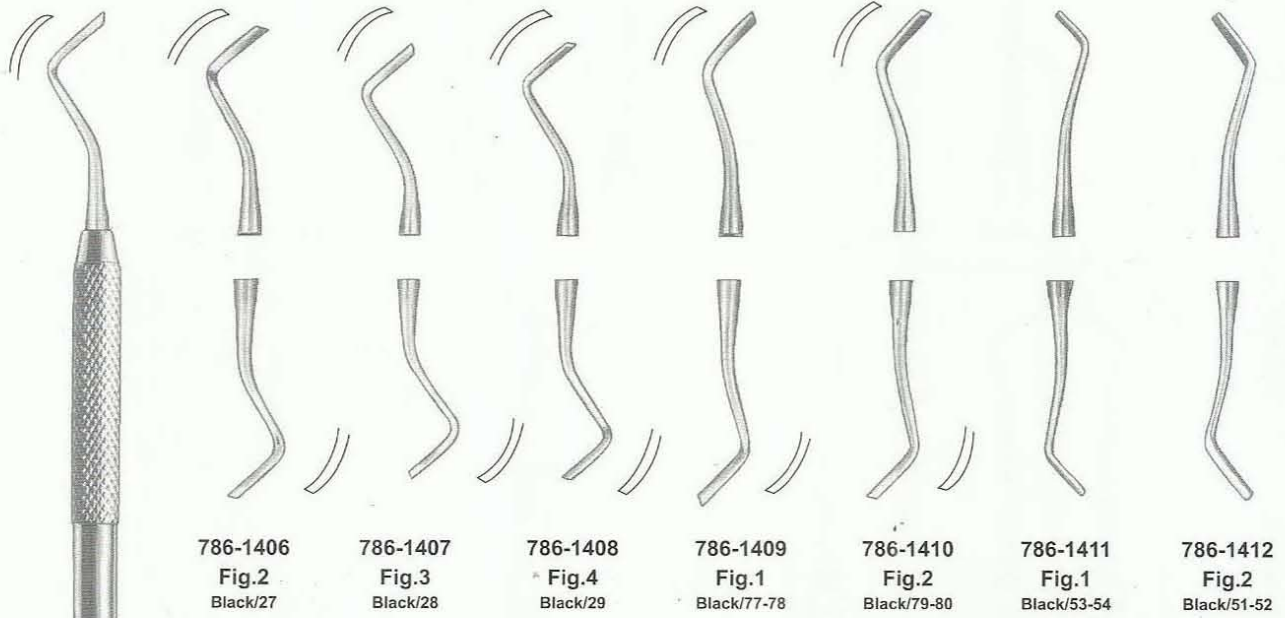

786-1406
Fig.2
Black/27

786-1407
Fig.3
Black/28

786-1408
Fig.4
Black/29

786-1409
Fig.1
Black/77-78

786-1410
Fig.2
Black/79-80

786-1411
Fig.1
Black/53-54

786-1412
Fig.2
Black/51-52

786-1405
Fig.1
Black/26



786-1413
Fig.1/2
Wedelstaet



786-1414
Fig.3/4
Wedelstaet



786-1415
Fig.5/6
Wedelstaet



786-1416
Fig.1/2
TG Chisel

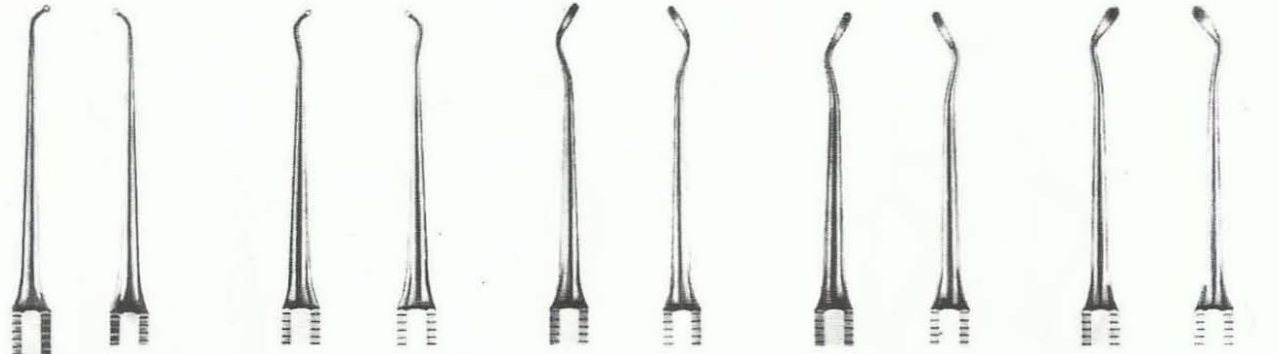

786-1418 786-1419 786-1420 786-1421 786-1422 786-1423 786-1424 786-1425 786-1426

Darby-Perry

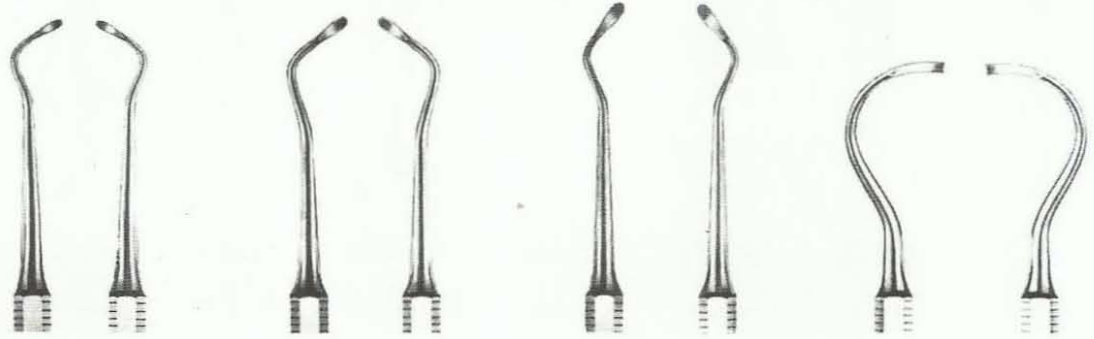

786-1427 786-1428 786-1429 786-1430 786-1431 786-1432 786-1433 786-1434

Darby-Perry

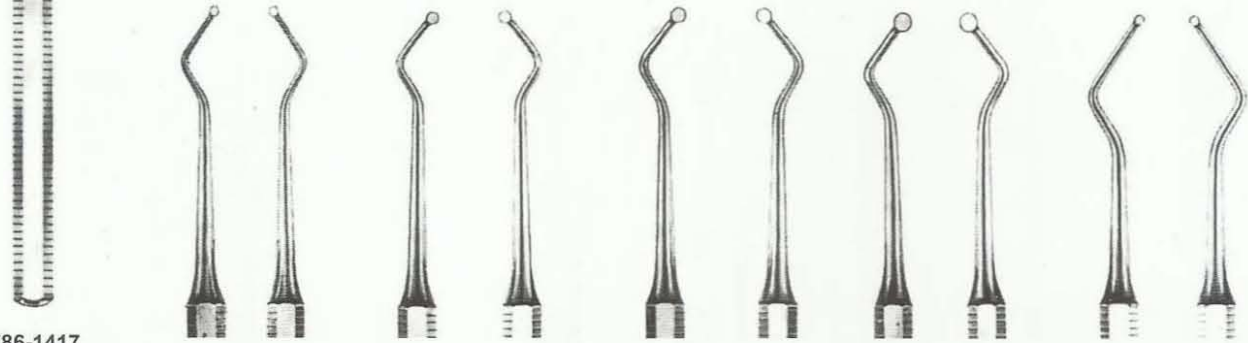

786-1417
 Darby-Perry

786-1435 786-1436 786-1437 786-1438 786-1439 786-1440 786-1441 786-1442 786-1443 786-1444

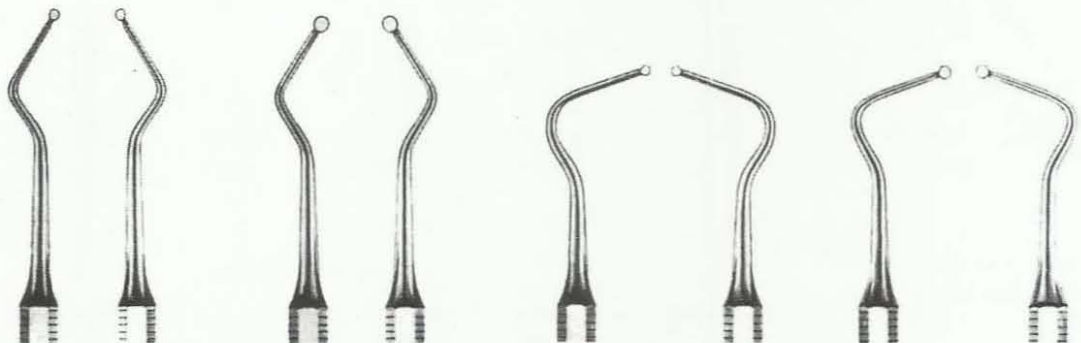

786-1445 786-1446 786-1447 786-1448 786-1449 786-1450 786-1451 786-1452



Excavatoren



786-1453
White

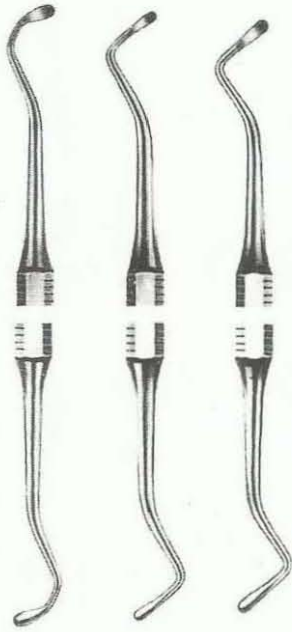

786-1454 786-1455 786-1456
White



786-1459
72/73

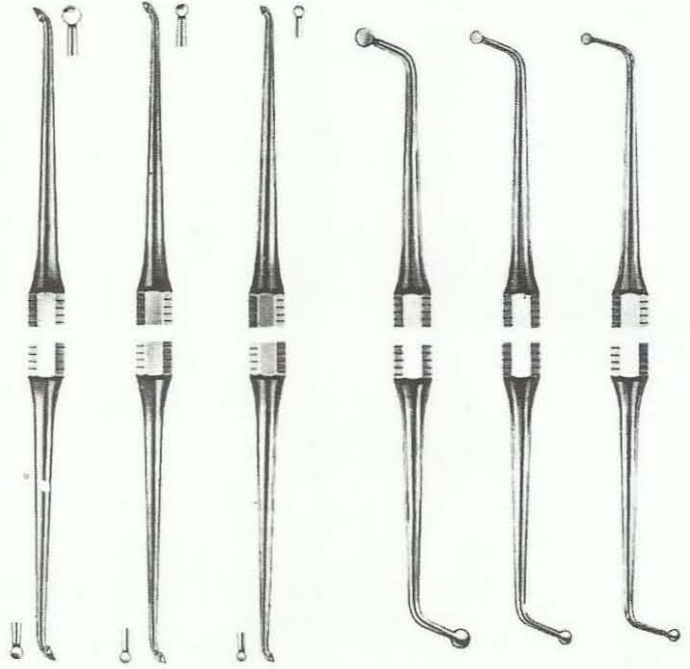

786-1460 786-1461 786-1462 786-1463 786-1464 786-1465
73/74 74/111 111/112 113/114 115/116 117/118

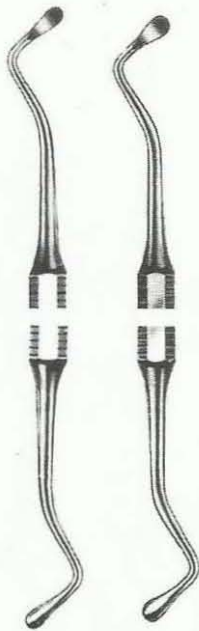

786-1457 786-1458
White

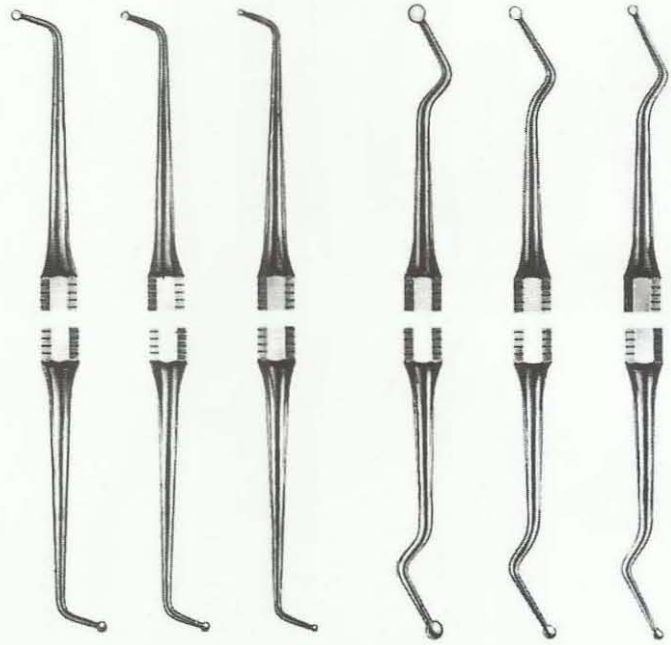

786-1466 786-1467 786-1468 786-1469 786-1470 786-1471
119/120 121/122 123/124 125/126 127/128 129/130

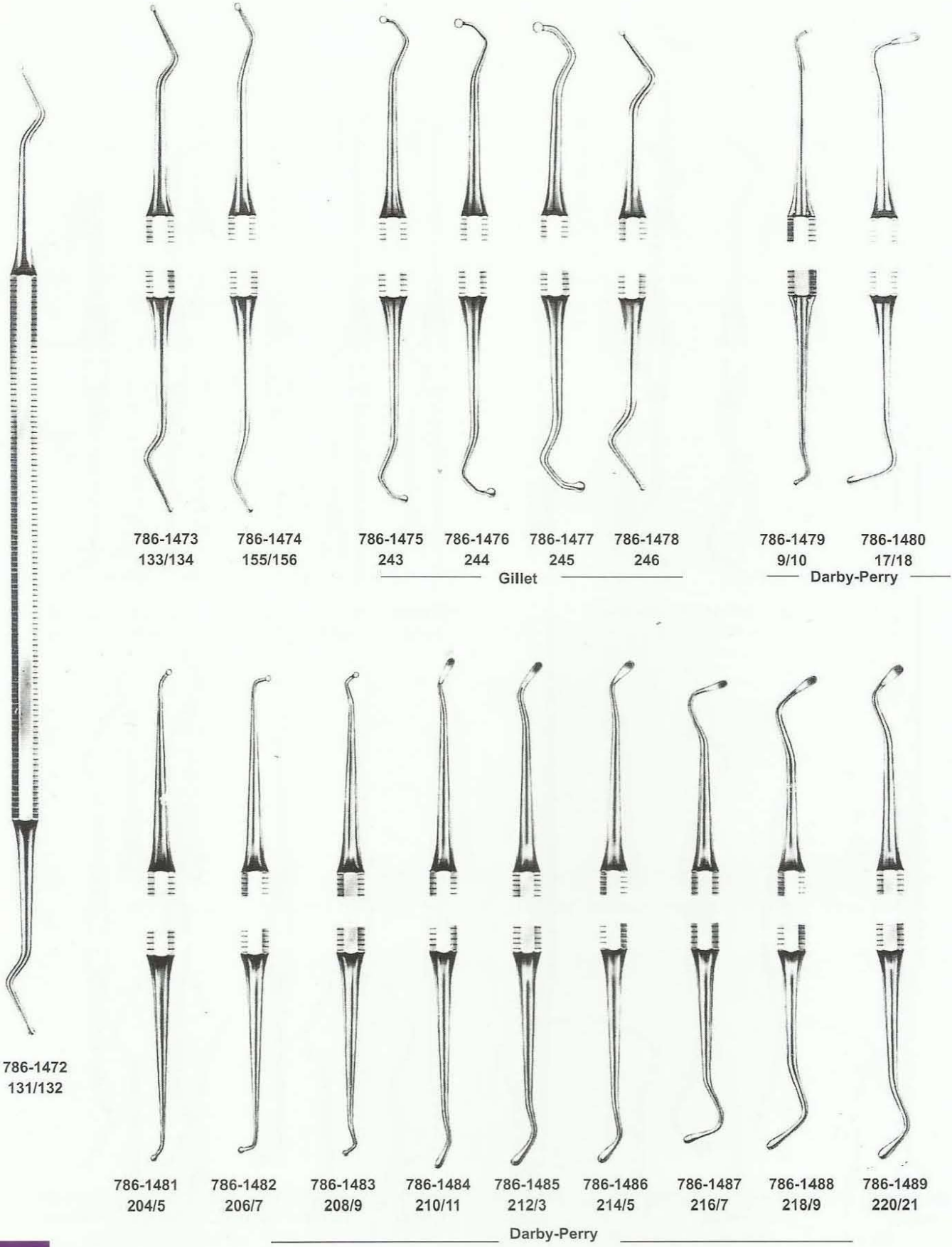



786-1490
 Crown removers

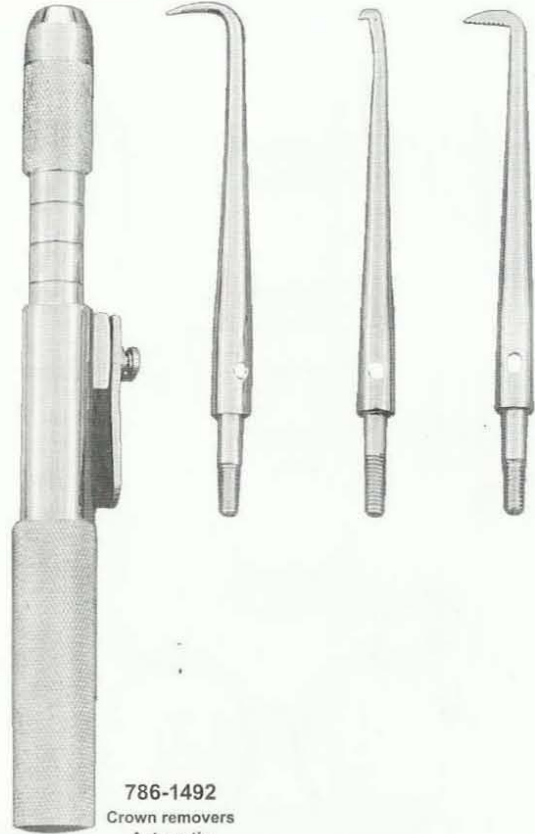

786-1492
 Crown removers
 Automatic



786-1491
 Crown removers

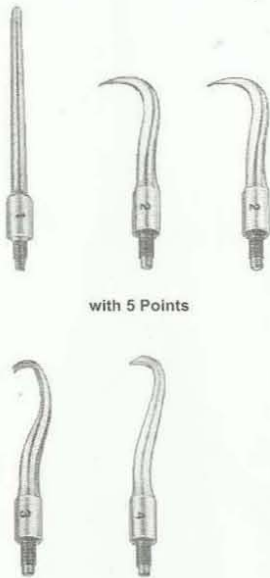

with 5 Points

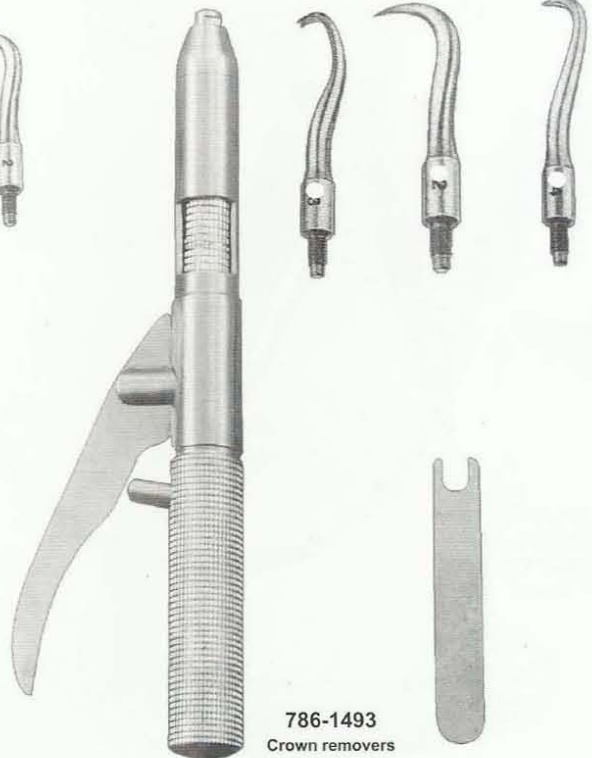

786-1493
 Crown removers

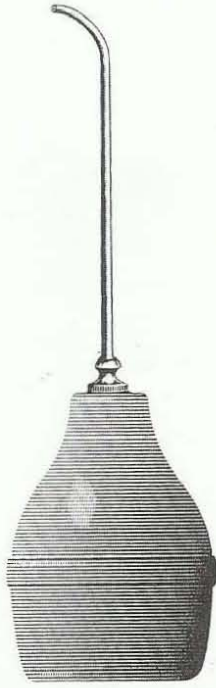

786-1502
Chip Blower



786-1503



786-1504



786-1505

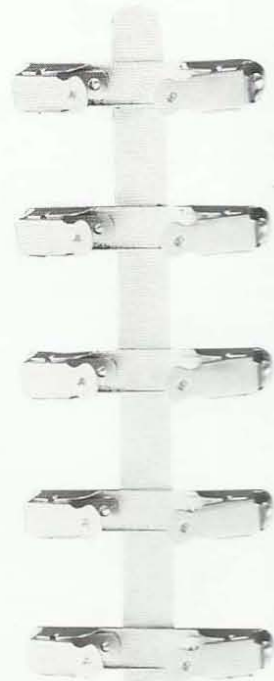

786-1506
Film Holder for
10 films
786-1507
6 films
786-1508
14 films



786-1509
Water Syringe

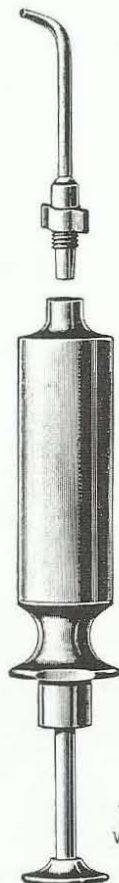

786-1510
Water Syringe



786-1511
Napkin holder with plastic band

786-1512
Napkin holder with metal chain



Articulating
paper forceps

786-1513
15 cm

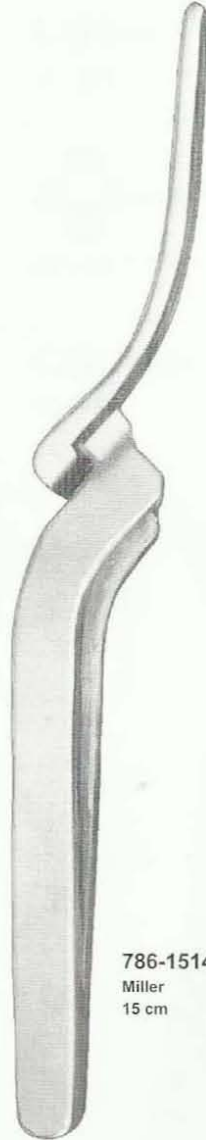

786-1514
Miller
15 cm

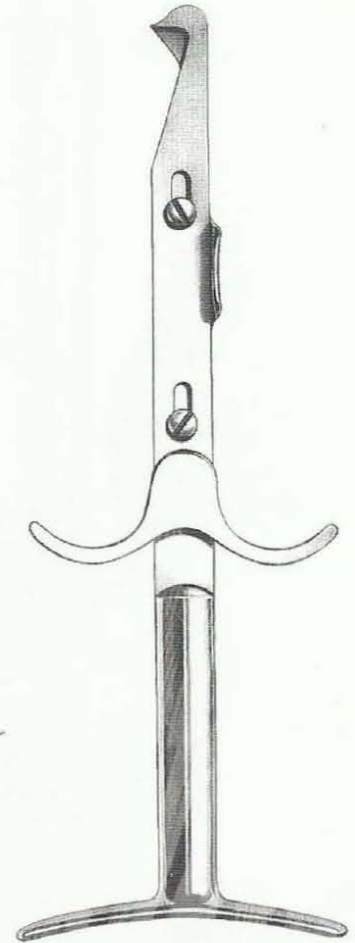

786-1515
Crown Spreader

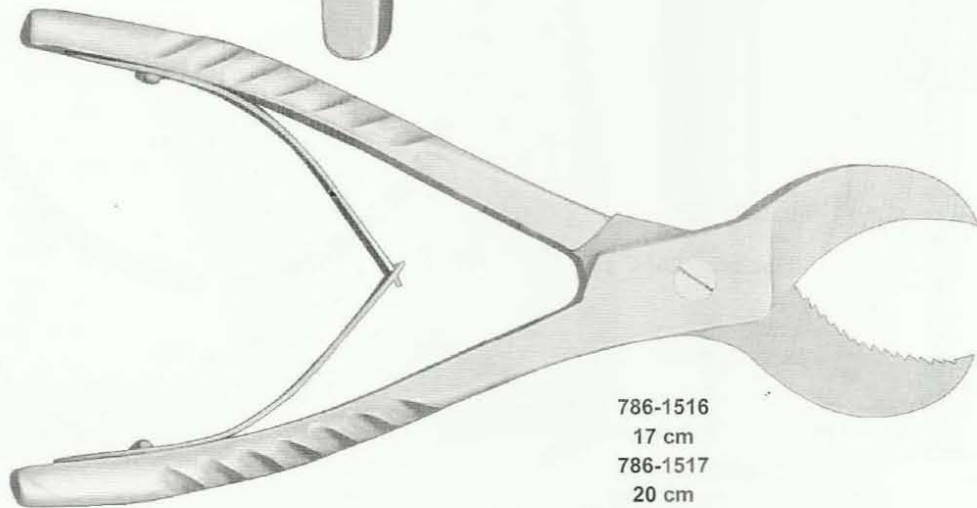

786-1516
17 cm
786-1517
20 cm
Plaster Cutting Plier

Matrix Retainers

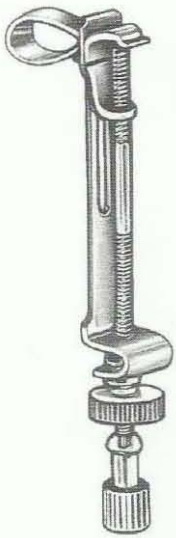

786-1518 - 5mm
 786-1519 - 6mm
 786-1520 - 7mm
 Ivory 8

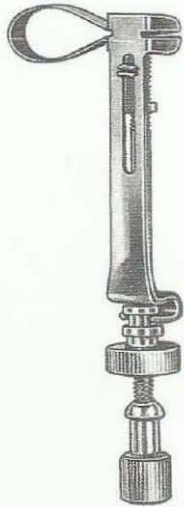

786-1521
 Ivory 8 N



786-1522
 Ivory 8



786-1523
 Siqveland-Narrow
 786-1524
 Siqveland-Wide



786-1525
 Fig. 1
 Tofflemire-Universal

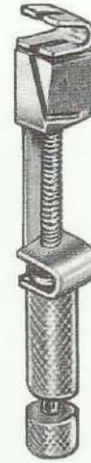

786-1526
 Fig. 3
 Tofflemire-Senior



786-1527
 Fig. 2
 Tofflemire-junior



Adjustable

786-1528
 Fig. 2
 Didner 8P

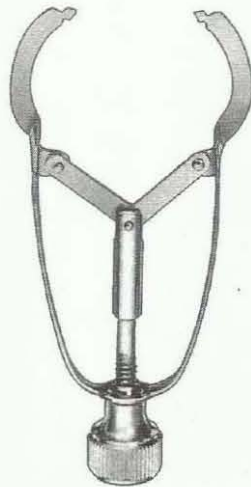

786-1529
 Ivory

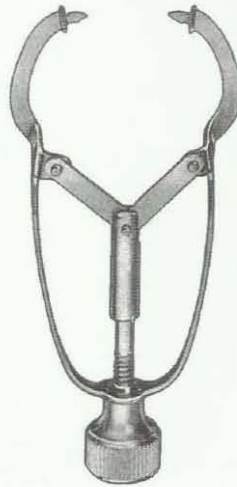

With lateral shields

786-1530
 Ivory

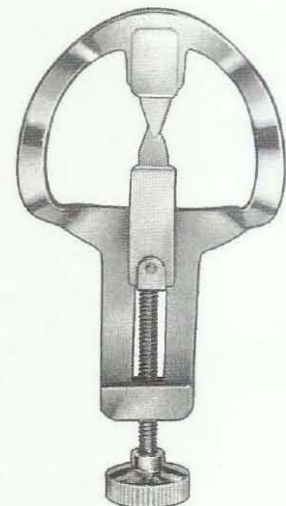

786-1531
 Ivory
 Separator

PERIODONTIA



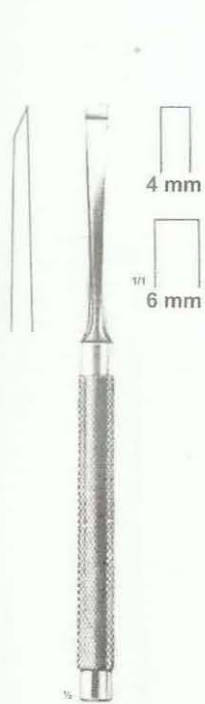

786-1532/4 mm
786-1533/6 mm
Lucas 16 cm



786-1534/3 mm
786-1535/5 mm
Lucas 16 cm



Mini-Lexer
18 cm / 7"
Handle of artificial wood



786-1536
4 mm



786-1537
6 mm



786-1538
8 mm



786-1539
10 mm



312
12 mm



Mini-Lexer
18 cm / 7"
Handle of artificial wood



786-1540
4 mm



786-1541
6 mm



786-1542
8 mm



786-1543
10 mm



412
12 mm

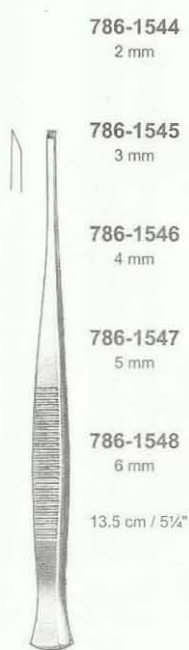

Partsch
Chisels

786-1544
2 mm



786-1549
2 mm

786-1545
3 mm



786-1550
3 mm

786-1546
4 mm



786-1551
4 mm

786-1547
5 mm



786-1552
5 mm

786-1548
6 mm



786-1553
6 mm

13.5 cm / 5 1/4"

17 cm / 6 3/4"



Partsch
Gouges

786-1554
2 mm



786-1559
2 mm

786-1555
3 mm



786-1560
3 mm

786-1556
4 mm



786-1561
4 mm

786-1557
5 mm



786-1562
5 mm

786-1558
6 mm



786-1563
6 mm

13.5 cm / 5 1/4"

17 cm / 5 3/4"



Buckley
16 cm / 6 1/4"



786-1564
2 mm



786-1565
3 mm



786-1566
4 mm

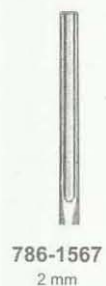

786-1567
2 mm

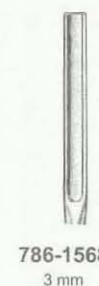

786-1568
3 mm



786-1569
4 mm

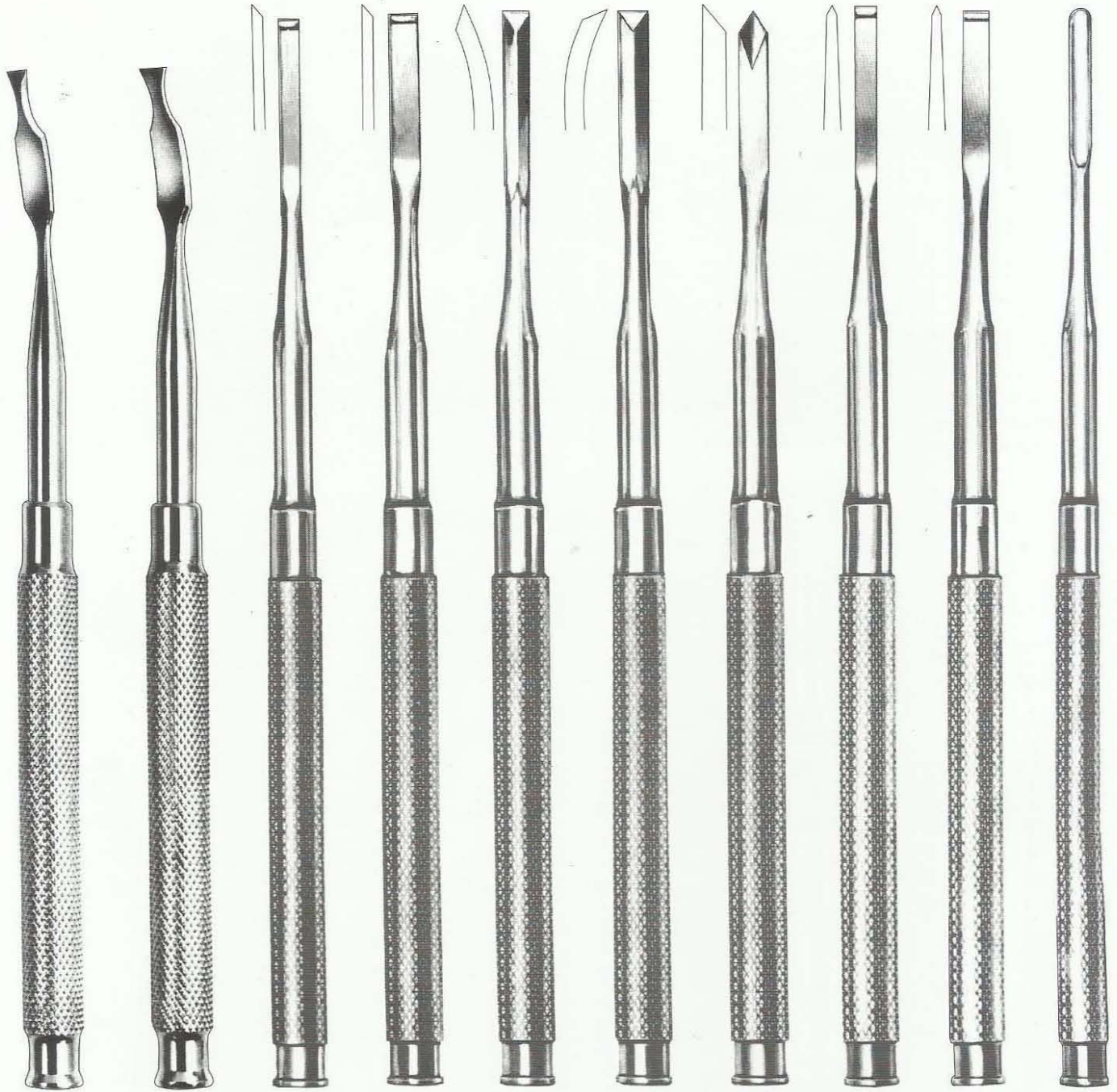

Ochsenbein
 786-1570
 Fig. 1

Ochsenbein
 786-1571
 Fig. 2

Garndner
 786-1572
 Fig. 1

Garndner
 786-1573
 Fig. 2

Garndner
 786-1574
 Fig. 5

Garndner
 786-1575
 Fig. 5R

Garndner
 786-1576
 Fig. 6

Wakefield
 786-1577
 Fig. 1W

Wakefield
 786-1578
 Fig. 2W

Buckley
 786-1579
 Fig. 3



15.5 cm / 6"



786-1580
2 mm \varnothing



786-1581
3 mm \varnothing



786-1582
4 mm \varnothing



786-1583
5 mm \varnothing



786-1584
6 mm \varnothing



786-1585
8 mm \varnothing



786-1586
10 mm \varnothing

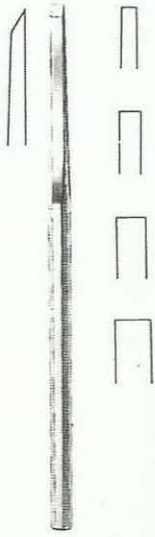

786-1587/2 mm
 786-1588/3 mm
 786-1589/4 mm
 786-1590/5 mm
 Bishop 15 cm

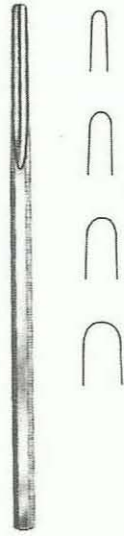

786-1591/2 mm
 786-1592/3 mm
 786-1593/4 mm
 786-1594/5 mm
 Bishop 15 cm

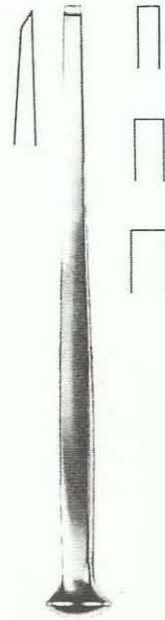

786-1595/3 mm
 786-1596/4 mm
 786-1597/5 mm
 Alexander 17 1/2 cm

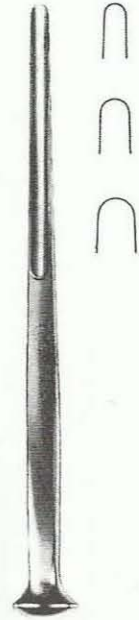

786-1598/3 mm
 786-1599/4 mm
 786-1600/5 mm
 Alexander 17 1/2 cm



786-1601/1
 Williger 24 cm
 Bleifüllung
 lead filled
 garni de plomb
 rellonado de plomo



786-1602/2
 16 1/2 cm
 Bleifüllung
 lead filled
 garni de plomb
 rellonado de plomo





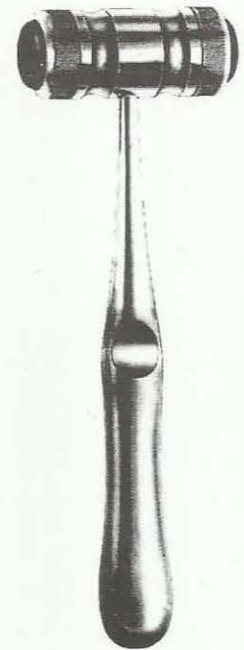







786-1603/3
 Gardner 14 cm
 Stahl, massiv
 steel, solid
 acier, solide
 acero, macizo



786-1604/4
 Mead 17 cm
 mit Kunststoffbacken
 with caps of plastic
 avec plaques de plastic
 con tapas de plástico











Bone Curettes (Sharp Spoons)
 Scharfe Löffel
 Curetas (cucharillas) cortantes



- | | |
|---|--|
| 
786-1605
Fig. 0000 | 
786-1610
Fig. 000 |
| 
786-1606
Fig. 00 | 
786-1611
Fig. 0 |
| 
786-1607
Fig. 1 | 
786-1612
Fig. 2 |
| 
786-1608
Fig. 3 | 
786-1613
Fig. 4 |
| 
786-1609
Fig. 5 | 
786-1614
Fig. 6 |













Volkmann

- | | |
|---|--|
| 
786-1615
Fig. 0000 | 
786-1620
Fig. 000 |
| 
786-1616
Fig. 00 | 
786-1621
Fig. 0 |
| 
786-1617
Fig. 1 | 
786-1622
Fig. 2 |
| 
786-1618
Fig. 3 | 
786-1623
Fig. 4 |
| 
786-1619
Fig. 5 | 
786-1624
Fig. 6 |



Bruns

- | | |
|---|--|
| 
786-1625
Fig. 0000 | 
786-1630
Fig. 000 |
| 
786-1626
Fig. 00 | 
786-1631
Fig. 0 |
| 
786-1627
Fig. 1 | 
786-1632
Fig. 2 |
| 
786-1628
Fig. 3 | 
786-1633
Fig. 4 |
| 
786-1629
Fig. 5 | 
786-1634
Fig. 6 |

Volkmann
 17 cm / 6 3/4"
 Handle of artificial wood



Molt
 16.5 cm / 6 1/2"

- | | | | | |
|--|--|--|---|---|
| 
786-1635
Fig. 1 | 
786-1636
Fig. 2 | 
786-1637
Fig. 4 | 
786-1638
Fig. 5L | 
786-1639
Fig. 6R |
|--|--|--|---|---|



Willger
 17.5 cm / 7"







- | | |
|---|---|
| 
786-1640
Fig. 00 | 
786-1642
Fig. 00 |
| 
786-1641
Fig. 0 | 
786-1643
Fig. 0 |

Bone Curettes (Sharp Spoons)
 Scharfe Löffel
 Curetas (cucharillas) cortantes









Mod. USA
 16 cm / 6 1/4"









- | | | |
|---|---|---|
| 
786-1650
Fig. 1 | 
786-1651
Fig. 2 | 
786-1652
Fig. 3 |
| 
786-1653
Fig. 4 | 
786-1654
Fig. 5 | 
786-1655
Fig. 6 |



- | | | |
|---|---|---|
| 
786-1644
Fig. 1 | 
786-1645
Fig. 2 | 
786-1646
Fig. 3 |
| 
786-1647
Fig. 4 | 
786-1648
Fig. 5 | 
786-1649
Fig. 6 |



- | | | |
|---|---|---|
| 
786-1656
Fig. 1 | 
786-1657
Fig. 2 | 
786-1658
Fig. 3 |
| 
786-1659
Fig. 4 | 
786-1660
Fig. 5 | 
786-1661
Fig. 6 |









Martini
 14 cm / 5 1/2"

- | | |
|--|---|
| 
786-1662
Fig. 00/0 | 
786-1663
Fig. 0/1 |
| 
786-1664
Fig. 1/2 | |



Williger
 13.5 cm / 5 1/4"

- | | |
|---|--|
| 
786-1665
00 | 
0 |
| 
786-1666
1 | 
1 |
| 
786-1667
2 | 
2 |



Williger-Mod
 15.5 cm / 6"

- | | |
|--|--|
| 
786-1668
00/00 | 
786-1669
0/0 |
| 
786-1670
1/1 | |



Miller-Colburn



Fig. 1



786-1671



Fig. 2



786-1672



Fig. 3



786-1673



Fig. 4



786-1674



Miller-Colburn



Fig. 1



786-1675



Fig. 2



786-1676



Fig. 3



786-1677

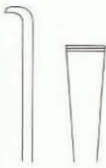

Fig. 4



786-1678

Periosteal Raspatories
 Raspatorien
 Legras-Periostomos



786-1679
5 mm
786-1680
6 mm
786-1681
7 mm

Williger
16 cm / 6 1/4"



Williger
786-1682
13 cm / 5"



Williger
786-1683
17 cm / 6 3/4"



Williger
786-1684
17 cm / 6 3/4"

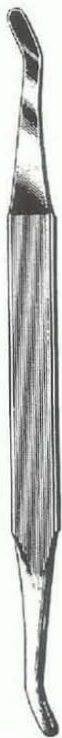

786-1685

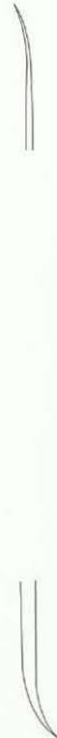

786-1686

Seldin



786-1687



786-1688

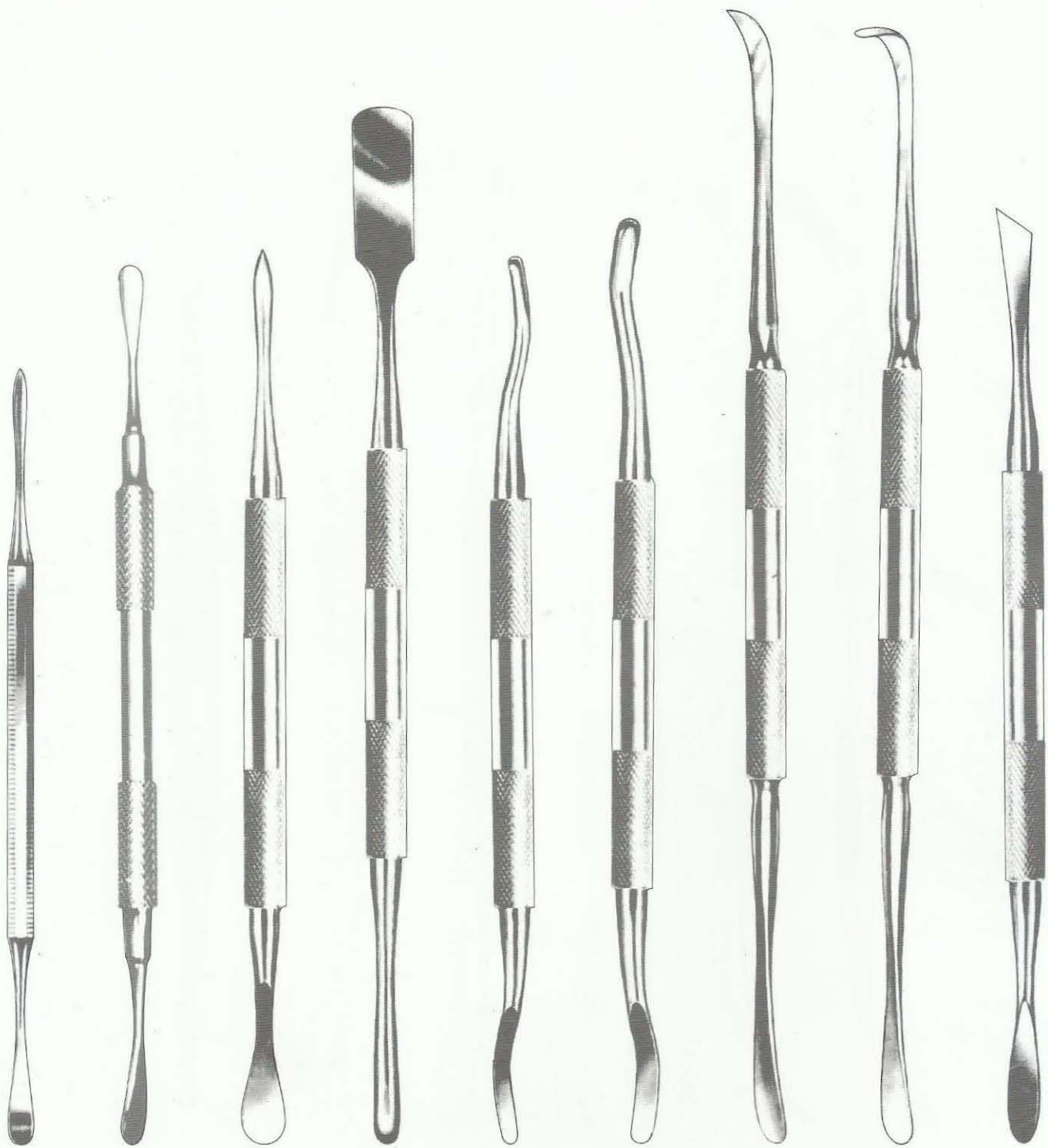

Beal
786-1689

Goldman-Fox
786-1690
GF

Molt
786-1691
M9

Prichard
786-1692
PR3

Hopkins
786-1693
Fig. 1

Hopkins
786-1694
Fig. 2

Freer
786-1695
Fig. 15

Freer
786-1696
Fig. 16

Mead
786-1697
Fig. 3

Bone Files
Knochenfeilen
Limas para alveolotomia

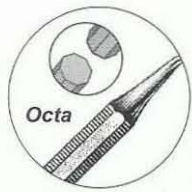

Octa

Add "O" to the same part numbers, for octa instruments.

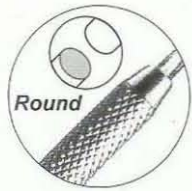

Round

Add "R" to the same part numbers, for solid round instruments.



Light

Add "L" to the same part numbers, for hollow round instruments.



Wahl
786-1698
Fig. 1

Wahl
786-1699
Fig. 2

Howard
786-1700
Fig. 12CA

Howard
786-1701
Fig. 12A

Howard
786-1702
Fig. 12

Polokoff
786-1703
Fig. 1

786-1704
Fig. 10



Bone Curettes

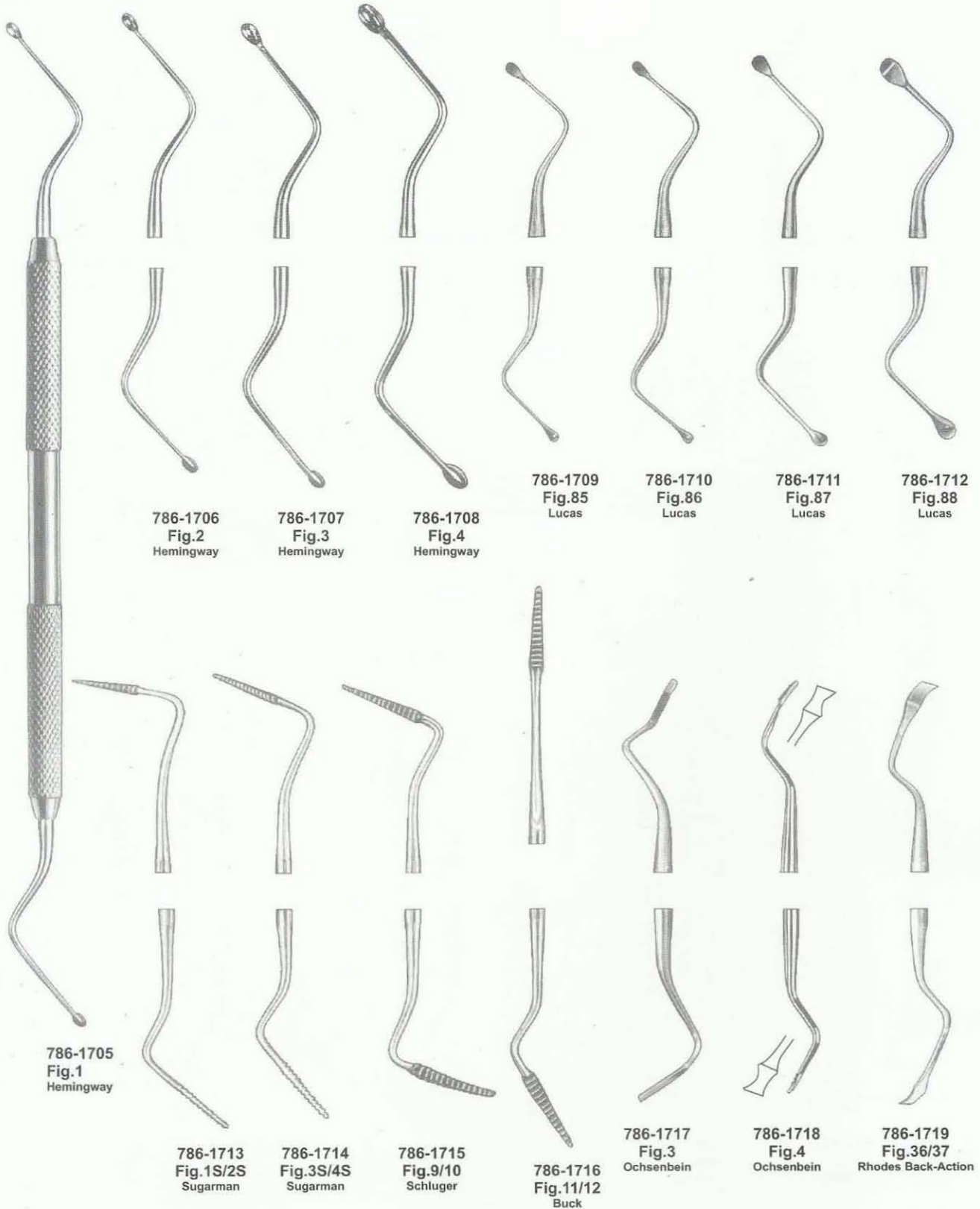





786-1733
 Fig.2R/2L
 Columbia

786-1734
 Fig.4R/4L
 Columbia

786-1735
 Fig.13/14
 Columbia

786-1736
 Fig.411/412

786-1737
 Fig.413/414

786-1738
 Fig.½
 Langer

786-1739
 Fig.3/4
 Langer

786-1732
 Fig.HU ½
 Curette



786-1740
 Fig.½
 Barnhart

786-1741
 Fig.5/6
 Barnhart

786-1742
 Fig.ME-1
 [10/11]

786-1743
 Fig.3/4
 Rule[23/24]

786-1744
 Fig.11/14
 Gracey
 Mesial-Distal

786-1745
 Fig.12/13
 Gracey
 Mesial-Distal

786-1746
 Fig.13/14
 Indiana University
 Anterior

786-1747
 Fig.17/18
 Indiana University
 Posterior

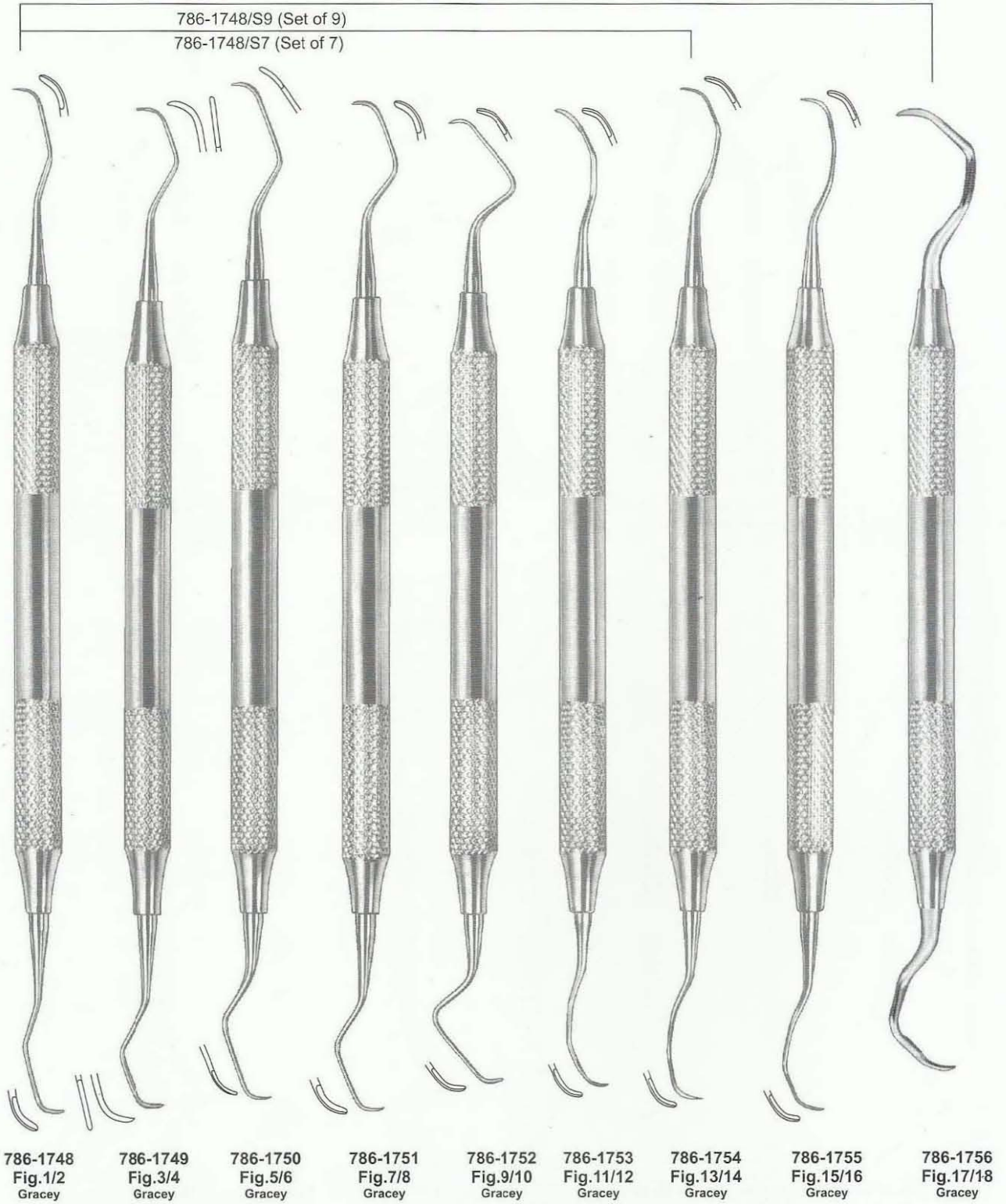

Gracey Curettes are also available in rigid points

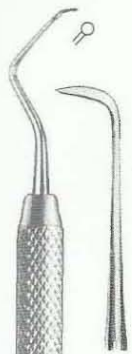

786-1758
 Fig.1
 Goldman-Fox



786-1759
 Fig.2
 Goldman-Fox



786-1760
 Fig.3
 Goldman-Fox



786-1761
 Fig.4
 Goldman-Fox



786-1762
 Fig.5
 Goldman-Fox



786-1763
 Fig.6
 Goldman-Fox



786-1764
 Fig.21
 Goldman-Fox



786-1757
 Fig.1
 De Marco



786-1765
 Fig.2
 De Marco



786-1766
 Fig.11/12
 Mc Call



786-1767
 Fig.11A/12A
 Mc Call



786-1768
 Fig.13/14
 Mc Call



786-1769
 Fig.13S/14S
 Mc Call



786-1770
 Fig.17S/18S
 Mc Call



786-1771
 Fig.19/20
 Mc Call

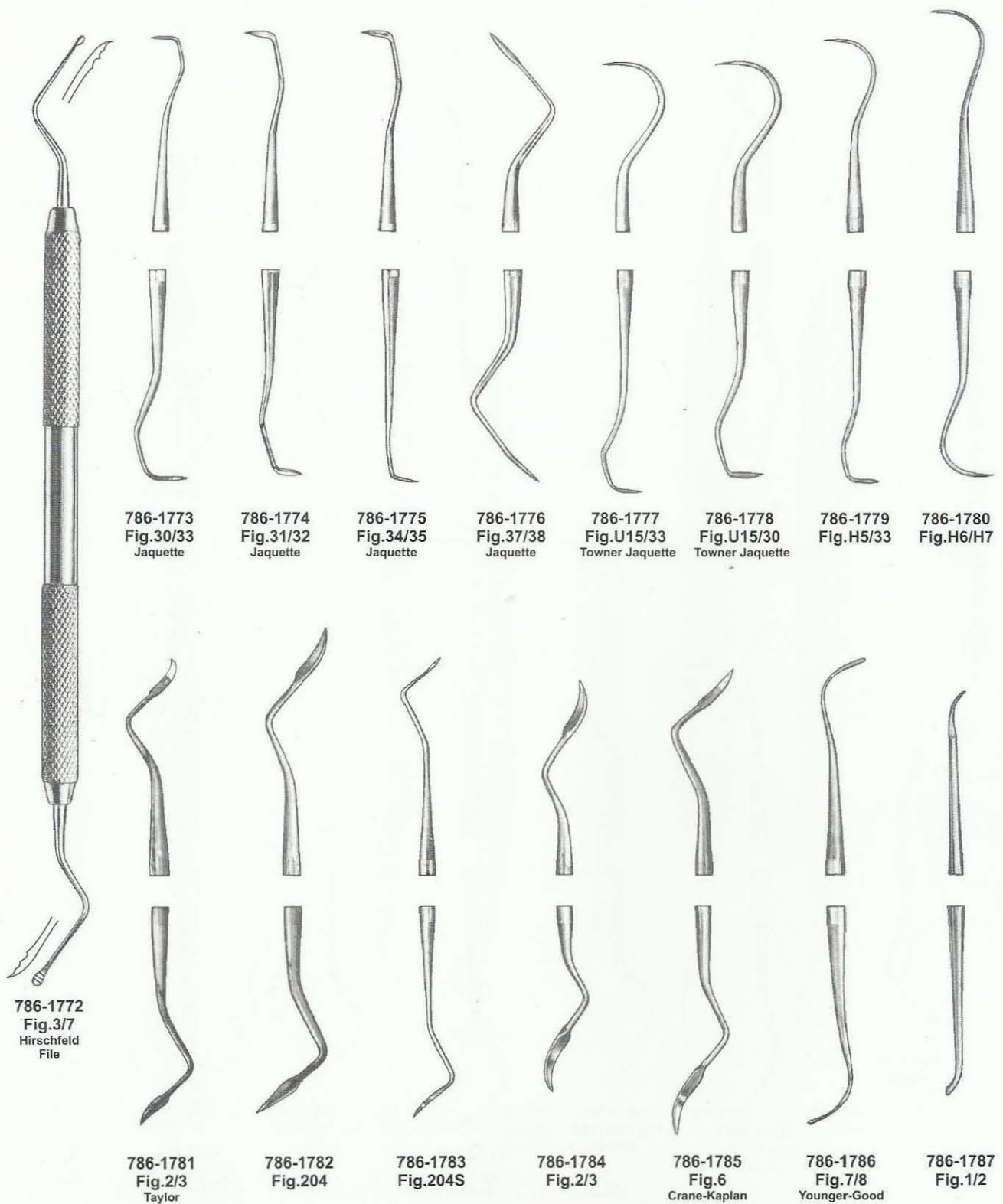



786-1788
 Fig.33



786-1789
 Fig.31



786-1790
 Fig.32



786-1791
 Fig.34



786-1792
 Fig.35



786-1793
 Fig.H5
 Hygienist



786-1794
 Fig.H6
 Hygienist



786-1795
 Fig.H7
 Hygienist

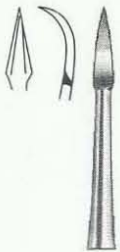

786-1796
 Fig.1



786-1797
 Fig.1L
 (sinistro)



786-1798
 Fig.1R
 (destro)



786-1799
 Fig.2L
 (sinistro)



786-1800
 Fig.2R
 (destro)



786-1801
 Fig.U15
 Towner



786-1802
 Zerfing-Chisel

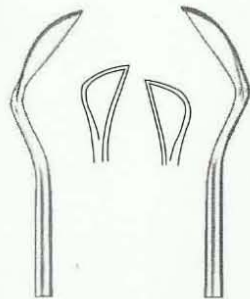

786-1803
 Fig.1
 (15K)
 Kirkland



786-1804
 Fig.2
 (16K)
 Kirkland



786-1805
 Fig.1
 Orban



786-1806
 Fig.2
 Orban



786-1807
 Fig.1
 TG Chisel



786-1808
 Fig.2
 TG Chisel

INSTRUMENTS TRAYS IMPRESSION TRAYS HOLLOWWARES

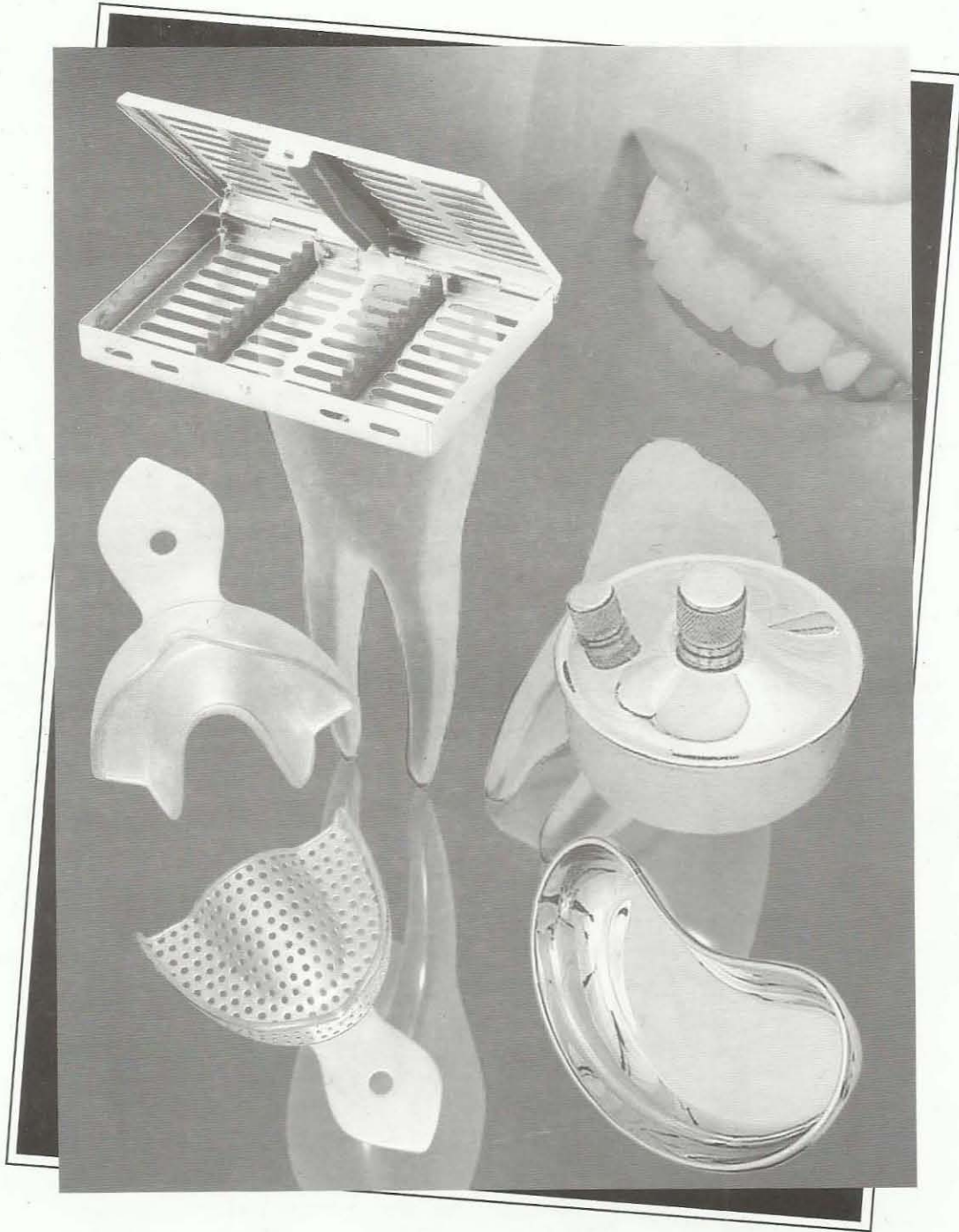

STERILIZATION CASSETTE TRAYS



786-1809
For 5 Instruments
786-1810
For 10 Instruments



786-1813 For 5 Instruments 185X65X20mm
786-1814 For 7 Instruments 185X90X20mm
786-1815 For 10 Instruments 185X125X20mm
786-1816 For 20 Instruments 280X185X25mm



786-1819 For 5 Instruments 185X70X35mm
786-1820 For 7 Instruments 185X105X35mm
786-1821 For 10 Instruments 185X145X35mm
786-1822 For 15 Instruments 205X185X45mm
786-1823 For 20 Instruments 290X185X35mm



786-1811
For 5 Instruments
786-1812
For 10 Instruments

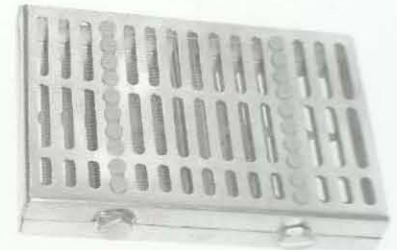

786-1817 For 5 Instruments 210X70X30mm
786-1818 For 10 Instruments 210X140X80mm

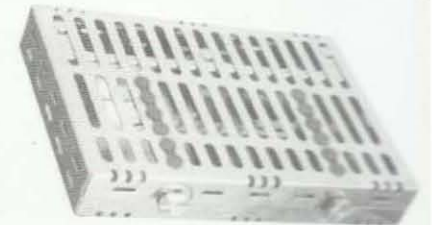

786-1824 For 5 Instruments 205X80mm
786-1825 For 10 Instruments 205X145mm
786-1826 For 20 Instruments 280X205mm



786-1827 For 6 Instruments 210X75X30mm

● Silicone Inserts are available in Following Colors:
RED - SKY BLUE - GREEN - YELLOW - ORANGE - PURPLE

Stainless Steel Instrument Trays
Made of 18/8 Stainless Steel

786-1828
Complete instrument tray with perforated base,
lid & insert frame for 16 instrument

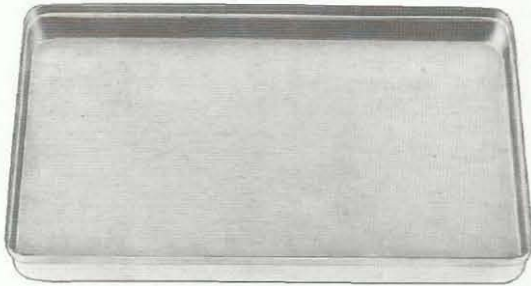

786-1829
Complete instrument tray with perforated base,
lid & insert frame for 23 instrument

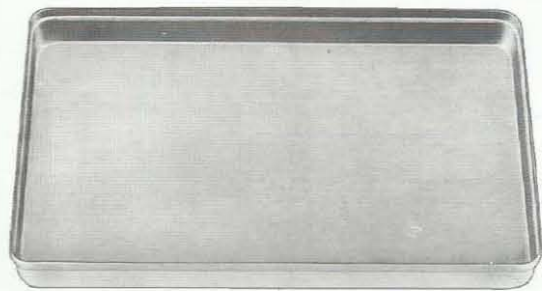

786-1830
Lid; dimensions mm,288x187x29

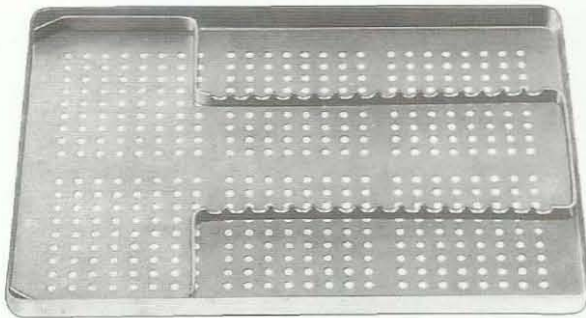

786-1831
Lid; dimensions mm,288x187x29

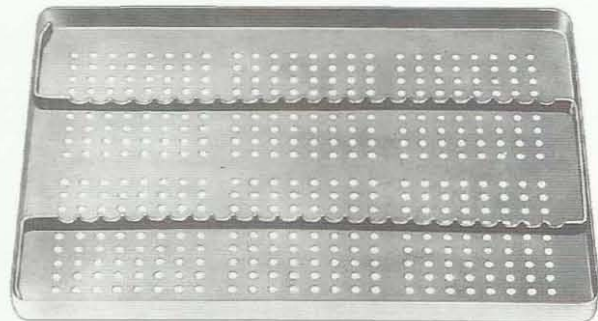

786-1832
Perforated base; dimensions 284x183x17 mm

786-1833
Complete instrument tray with solid base,
lid & insert frame for 16 instrument

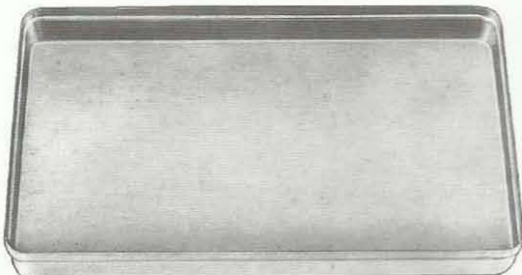

786-1836
Lid; dimensions 288x187x29 mm

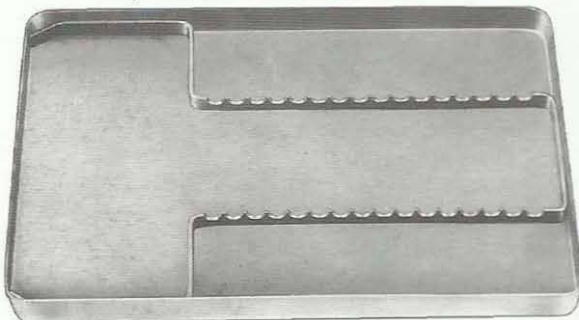

786-1838
Solid base; dimensions 284x183x17 mm

786-1834
Perforated base; dimensions 284x183x17 mm

786-1835
Complete instrument tray with solid base,
lid & insert frame for 23 instrument



786-1837
Lid; dimensions 288x187x29 mm

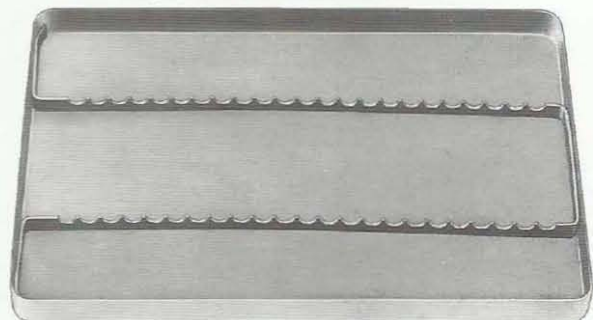

786-1839
Solid base; dimensions 284x183x17 mm

ALUMINIUM INSTRUMENT TRAYS



786-1840-Yellow
Aluminium Coloured Tray - SOLID
Size: 284x184x17 mm



786-1841-Green
Aluminium Coloured Tray - SOLID
Size: 284x184x17 mm



786-1842-Red
Aluminium Coloured Tray - SOLID
Size: 284x184x17 mm



786-1843-Grey
Aluminium Coloured Tray - SOLID
Size: 284x184x17 mm



786-1844-Blue
Aluminium Coloured Tray - SOLID
Size: 284x184x17 mm



786-1845-Grey
Aluminium Coloured Lid - SOLID
Size: 288x188x29 mm



786-1846-Yellow
Aluminium Coloured Tray - Perforated
Size: 284x184x17 mm



786-1847-Green
Aluminium Coloured Tray - Perforated
Size: 284x184x17 mm

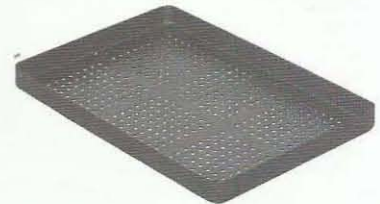

786-1848-Red
Aluminium Coloured Tray - Perforated
Size: 284x184x17 mm



786-1849-Grey
Aluminium Coloured Tray - Perforated
Size: 284x184x17 mm



786-1850-Blue
Aluminium Coloured Tray - Perforated
Size: 284x184x17 mm



786-1851-Grey
Aluminium Coloured Lid - Perforated
Size: 288x188x29 mm



786-1852/10
Insert Frame for 10 Instruments

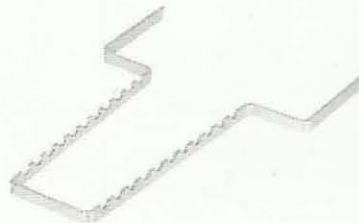

786-1853/11
Insert Frame for 11 Instruments



786-1854/17
Insert Frame for 17 Instruments

Stainless Steel Hollowares

Dental Instrument Tray

786-1855

150x100x10 mm
185x105x10 mm
200x100x10 mm
200x150x15 mm
280x190x20 mm
290x190x10 mm



786-1855



786-1856



786-1857



786-1858

Scalar Tray

786-1856

190x100x15 mm
Plain Base
190x100x15 mm
Grooved Base

Instrument Tray

786-1857

200x100x50 mm
200x150x50 mm
210x115x50 mm
220x150x50 mm
240x180x50 mm
250x200x50 mm
300x150x50 mm
300x200x50 mm
300x250x50 mm
please contact for more sizes



786-1859



786-1860



786-1861



786-1862

Instrument Tray with Lid

786-1858

200x100x50 mm
200x150x50 mm
210x115x50 mm
220x150x50 mm
240x180x50 mm
250x200x50 mm
300x150x50 mm
300x200x50 mm
300x250x50 mm
please contact for more sizes



786-1863



786-1864

Alcohol Lamps



786-1865



786-1866

Instrument Box with Lid

786-1859

170x70x30 mm
175x75x40 mm
180x60x30 mm
180x80x40 mm
180x90x40 mm
200x400x40 mm
200x100x50 mm
220x120x50 mm
230x150x50 mm
250x125x50 mm
260x150x50 mm
300x150x50 mm
Available with & without locks
please contact for more sizes



786-1867



786-1868

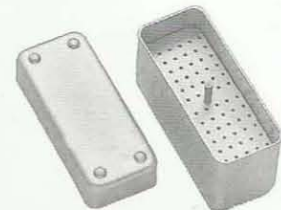

786-1869
Endodontic Box

Tray With Lid

786-1860

200x75x35 mm
210x115x45 mm

Kidney Tray

786-1861

150 mm
200 mm
250 mm
300 mm

Lotion Bowl

786-1862

80x40 mm
100x50 mm
120x55 mm
150x55 mm
180x60 mm

Sterilizing Drum

786-1863

100x100 mm
120x120 mm
150x150 mm
160x120 mm
190x140 mm
200x200 mm
240x120 mm
240x160 mm
240x240 mm

Gallipot

786-1864

2 OZ
4 OZ
6 OZ
8 OZ

Forceps Jar

786-1870

50x100 mm
50x170 mm



786-1870

Stainless Steel Impression Trays
 Abdruckloffel aus edelstahl
 Cubetas para impresiones de acero inoxidable



786-1871/10
 Solid Partial Set of 10

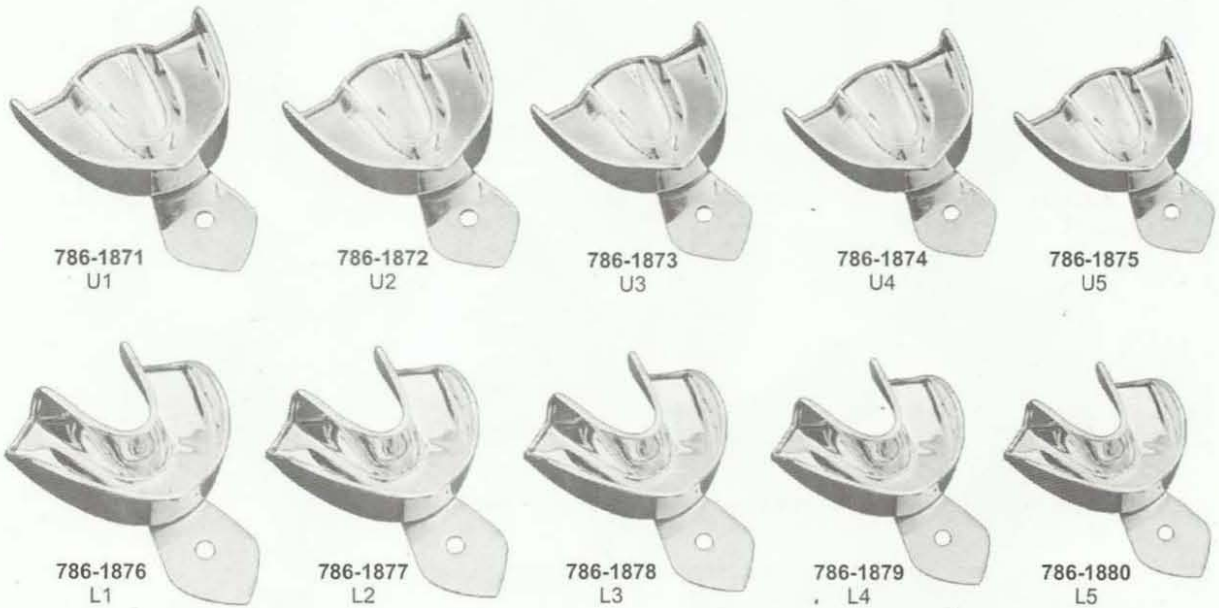

All the above impression trays are available in these 5 sizes

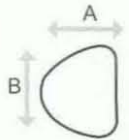

UPPER	U1	U2	U3	U4	U5
	A	62	60	53	54
B	83	75	73	69	68

All Dimension are in mm

LOWER	L1	L2	L3	L4	L5
	A	63	61	57	60
B	82	81	78	74	71

All Dimension are in mm

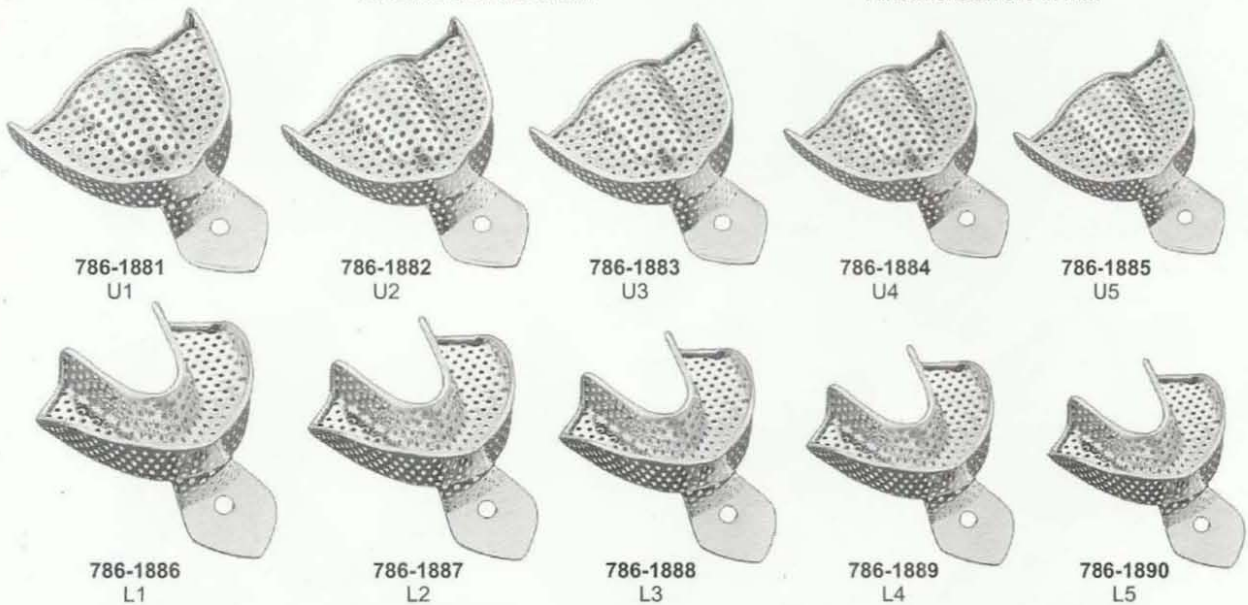
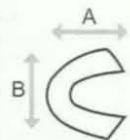

786-1881/10
 Perforated Partial Set of 10

Stainless Steel Impression Trays
 Abdruckkloffel aus edelstahl
 Cubetas para impresiones de acero inoxidable

786-1891/8
 Solid Full Denture Set of 8



All the above impression trays are available in these 4 sizes

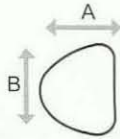

UPPER		XL	L	M	S
	A	70	67	64	60
B	79	76	70	73	

All Dimension are in mm

LOWER		XL	L	M	S
	A	64	64	60	57
B	86	70	73	70	

All Dimension are in mm

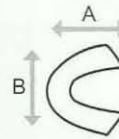

786-1899/8
 Perforated Full Denture Set of 8

Stainless Steel Impression Trays
 Abdruckloffel aus edelstahl
 Cubetas para impresiones de acero inoxidable



786-1907
U1



786-1908
U2



786-1909
U3

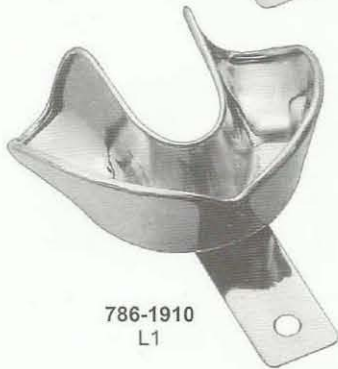

786-1910
L1



786-1911
L2



786-1912
L3

786-1907/6
Solid Set of 6

All the above impression trays are available in these 3 sizes

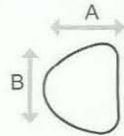

UPPER		U1	U2	U3
	A	67	64	57
	B	81	71	70

All Dimension are in mm

LOWER		L1	L2	L3
	A	60	57	54
	B	81	79	76

All Dimension are in mm

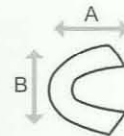

786-1913
U1



786-1914
U2



786-1915
U3



786-1916
L1



786-1917
L2



786-1918
L3

786-1913/6
Perforated Set of 6

Stainless Steel Impression Trays
Abdruckkloffel aus edelstahl
Cubetas para impresiones de acero inoxidable

786-1919/8
 Solid Full Denture Set of 8



All the above impression trays are available in these 4 sizes

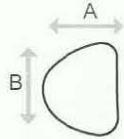

UPPER	XL	L	M	S
	A	70	67	64
B	79	76	70	73

All Dimension are in mm

LOWER	XL	L	M	S
	A	64	64	60
B	86	70	73	70

All Dimension are in mm

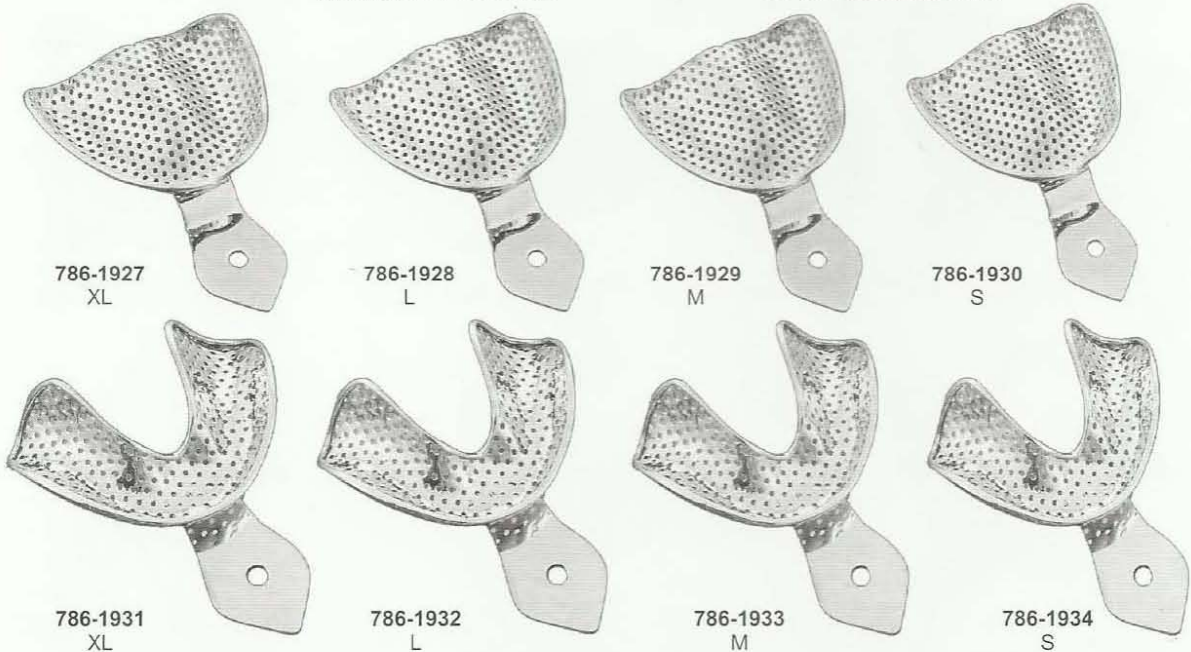
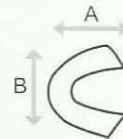

786-1927/8
 Perforated Full Denture Set of 8



English Pattern



786-1935/L
Lower

786-1935/8
Set of 8

Mesh type



786-1935/U
Upper



786-1936/L
Lower

786-1936/8
Set of 8
Punched type



786-1936/U
Upper



786-1937/L
Lower

786-1937/8
Set of 8

Solid type



786-1937/U
Upper

All the above impression trays are available in these 4 sizes

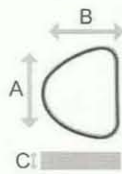

UPPER	Size	A	B	C
	0	67	50	12
	1	72	51	13
	2	78	55	15
	3	80	58	15

All Dimension are in mm

LOWER	Size	A	B	C
	0	70	50	14
	1	77	51	15
	2	79	55	15
	3	80	60	17

All Dimension are in mm

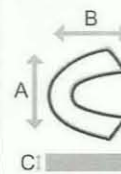

Impression trays for crown & bridge work



786-1938
U1P

Solid

786-1939
L1P



786-1940
U1P

Perforated

786-1941
L1P

English Pattern

786-1942/8
 Solid Full Denture
 Set of 8

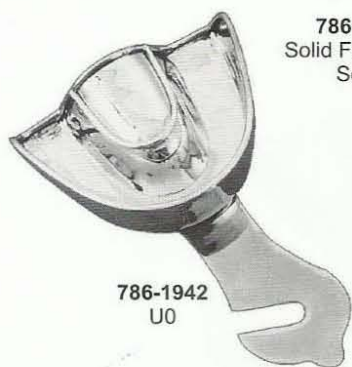

786-1942
 U0



786-1943
 U1



786-1944
 U2



786-1945
 U3



786-1946
 L0



786-1947
 L1

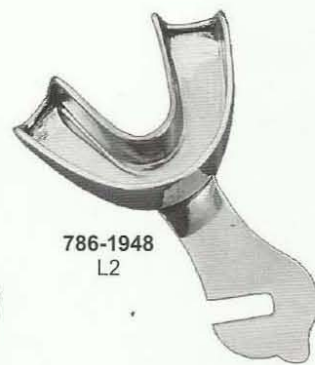

786-1948
 L2



786-1949
 L3

Upper Sizes 0,1,2,3,
 Depth of the tray 15,9 mm
 Height of palate 12,5 mm

Lower Sizes 0,1,2,3,
 Depth of the tray 12,9 mm



786-1950
 U0

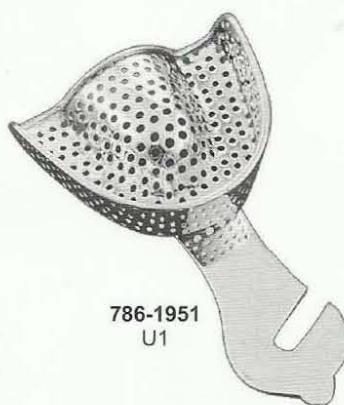

786-1951
 U1



786-1952
 U2

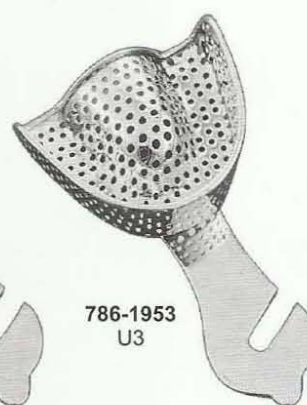

786-1953
 U3



786-1954
 L0



786-1955
 L1



786-1956
 L2



786-1957
 L3

786-1950/8
 Perforated Full Denture Set of 8

Stainless Steel Impression Trays
Abdruckloffel aus edelstahl
Cubetas para impresiones de acero inoxidable



786-1958
Adjustable
Perforated



786-1959
Adjustable
Solid



786-1960
For upper right jaw
For lower left jaw

Perforated

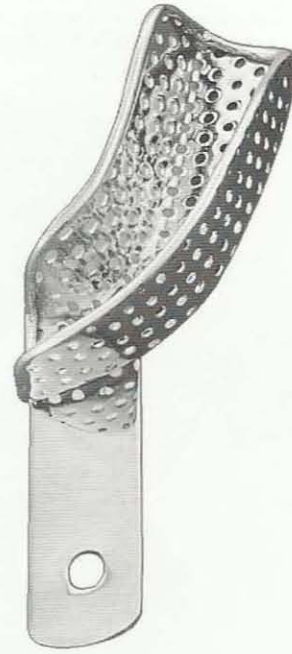

786-1961
For upper left jaw
For lower right jaw

Available in 4 Sizes
1..... 44 mm
2..... 55 mm
3..... 60 mm
4..... 65 mm

Also available in Solid pattern

LAB INSTRUMENTS

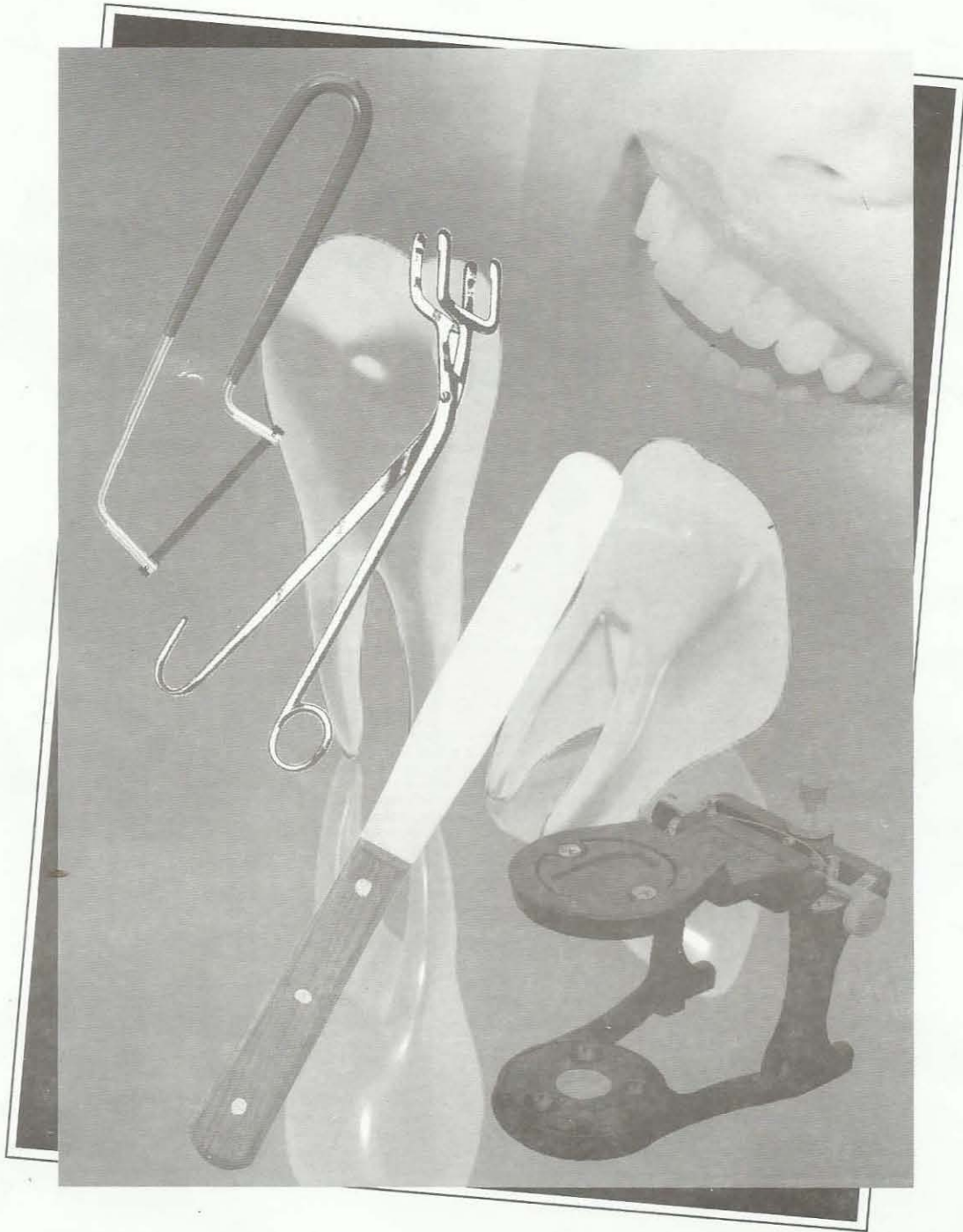



786-1962
Full Arch
Chrome Plated



786-1963
Denture
Chrome Plated

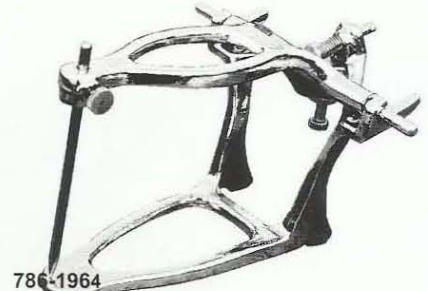

786-1964
Chrome Plated



786-1965
Crowned Bridge
Chrome Plated



786-1966
Full Denture
Chrome Plated



786-1967
Full Denture
Chrome Plated



786-1968
With Magnet



786-1969
With Magnet

Special Features
Lightweight anatomic articulator made of aluminum die-casting. It can be used following the geometrical laws of medium values (Bonewill triangle). Fixing according to centric. Automatic return to the hinge axis with springs. Perfect stability also in reversed position. Easy access and visibility to the lingual surfaces. Interchangeable self centering aluminum mounting plates or magnetic plates. Pure translation movement (key and instruction included). Anti-shock hinge rod in case articulator falls down. Bigger size lock screws for mounting plates.



786-1970



786-1971

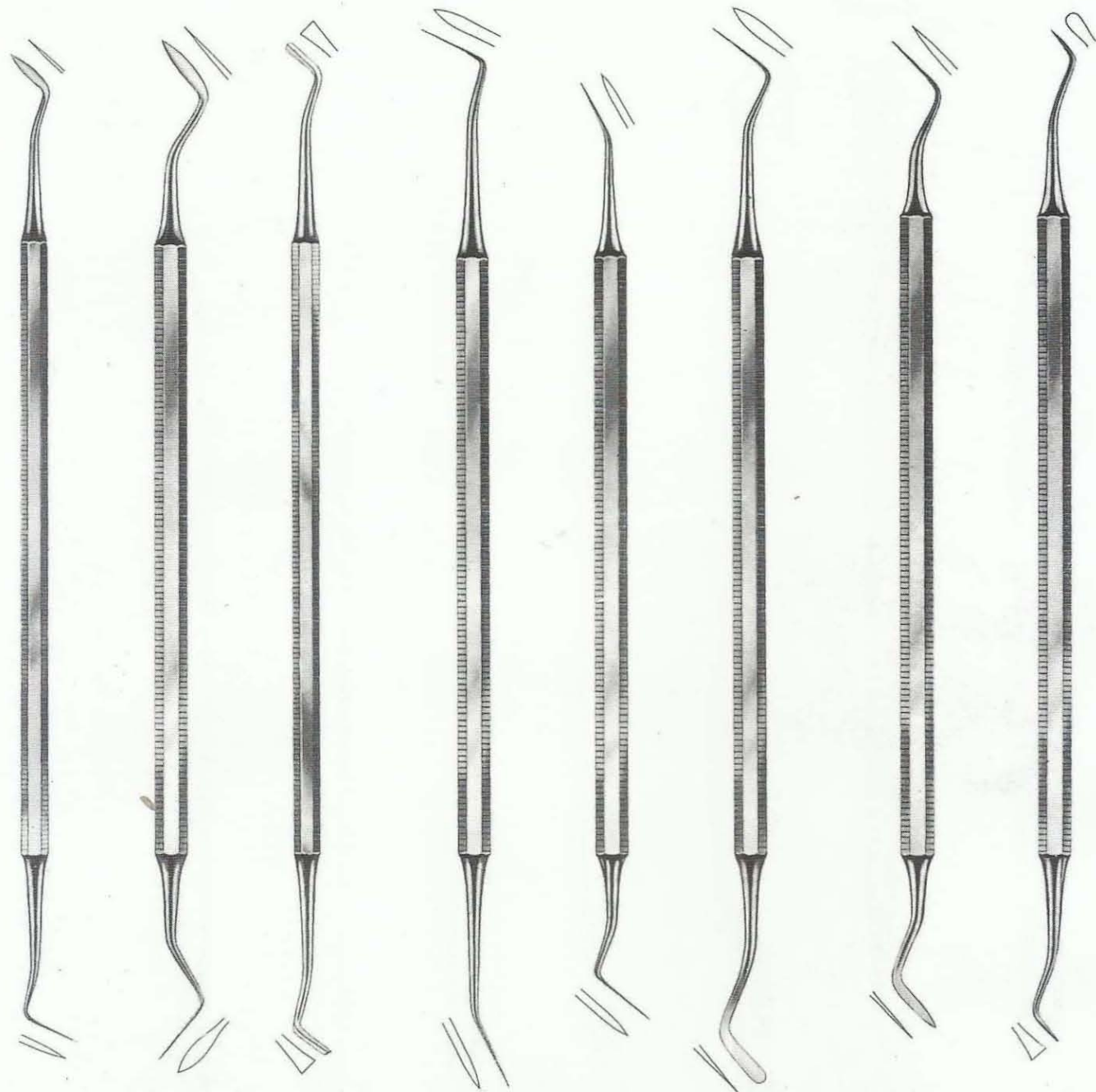

786-1972/2

786-1973/3

786-1974/1

Hollenback

786-1975/1

786-1976/1S

786-1977/2

Ward

786-1978/1

786-1979/3

Wall

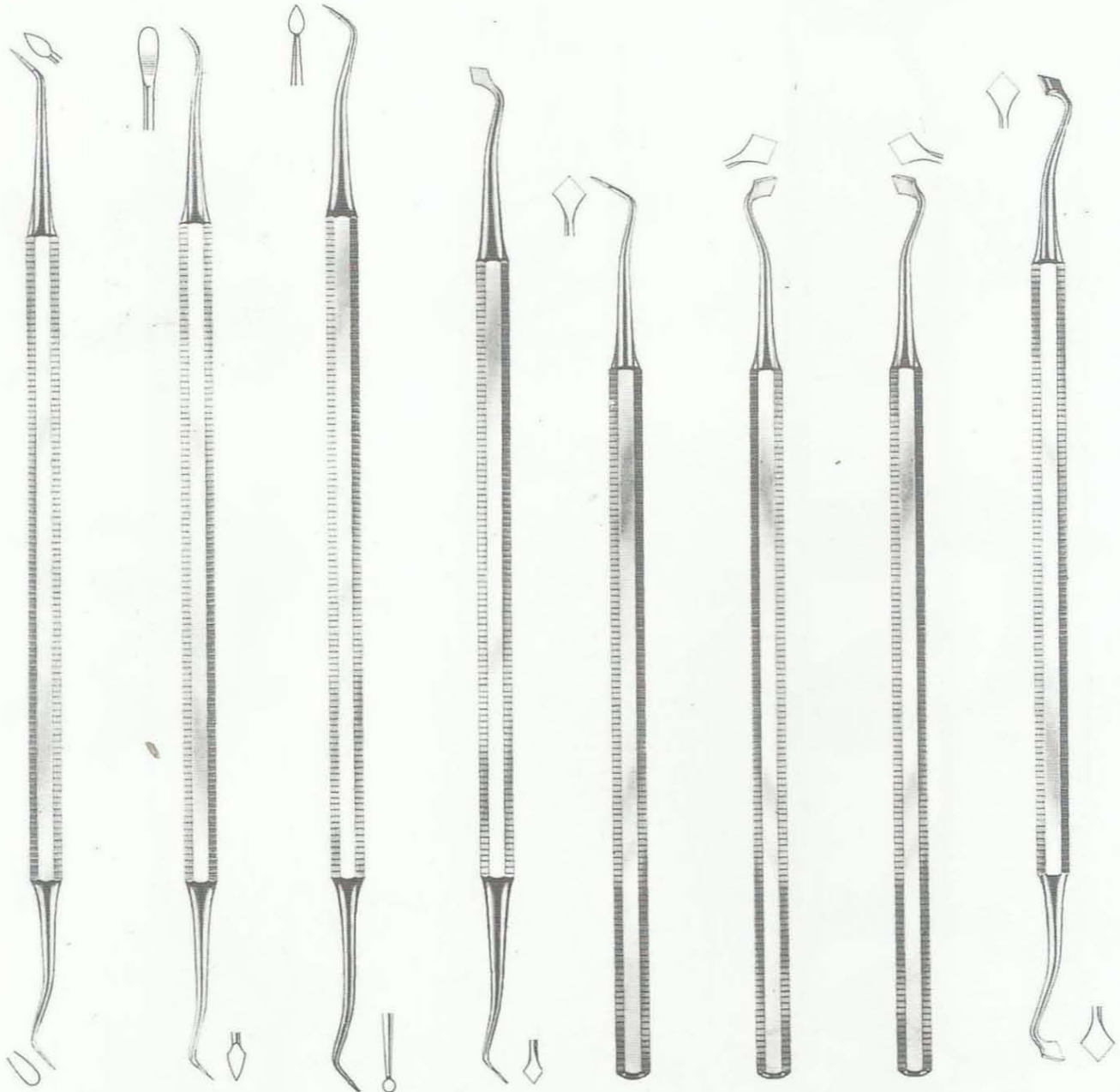

786-1980/1
WARD

786-1981/2
Tuft

786-1982/90 B

786-1983/1

786-1984/2

786-1985/6

786-1986/10

786-1987/6-10

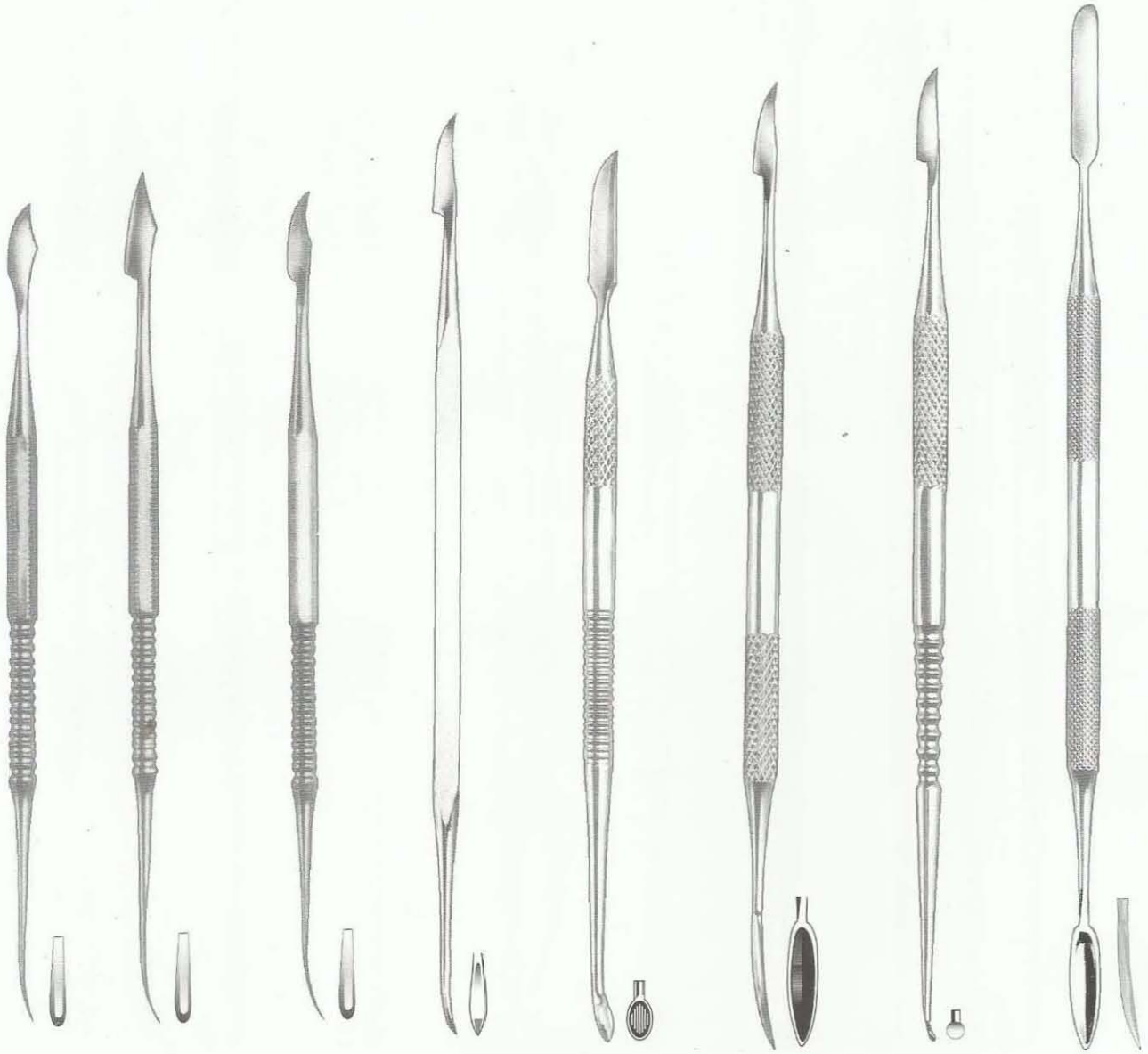

786-1988
Zahle

786-1989
Zahle

786-1990
Zahle

786-1991
Hylin

786-1992
Hylin-Ceramica

786-1993
Hylin-Sacred

786-1994
Hylin-Le Cron

786-1995



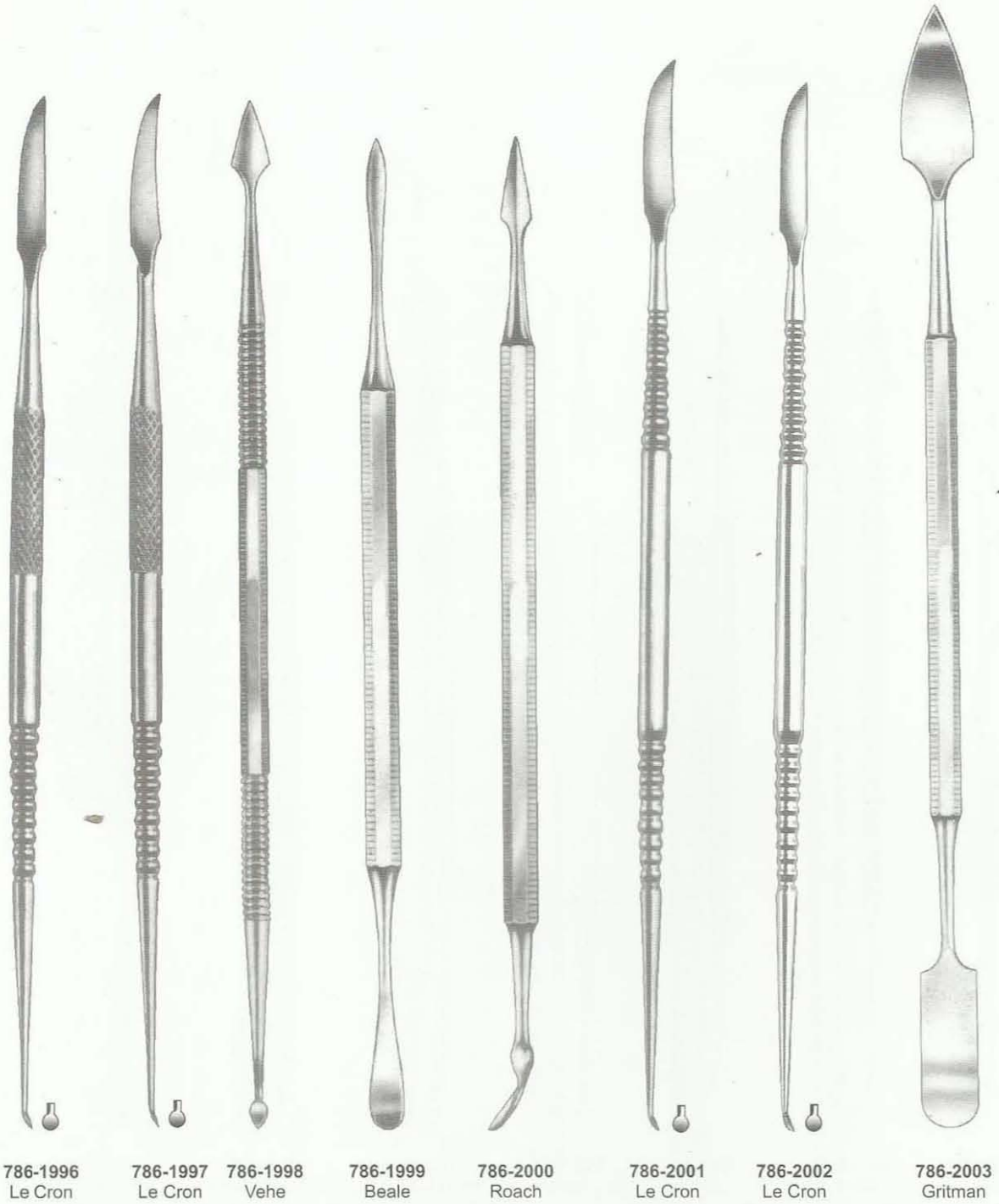



Wax and Modelling Carvers

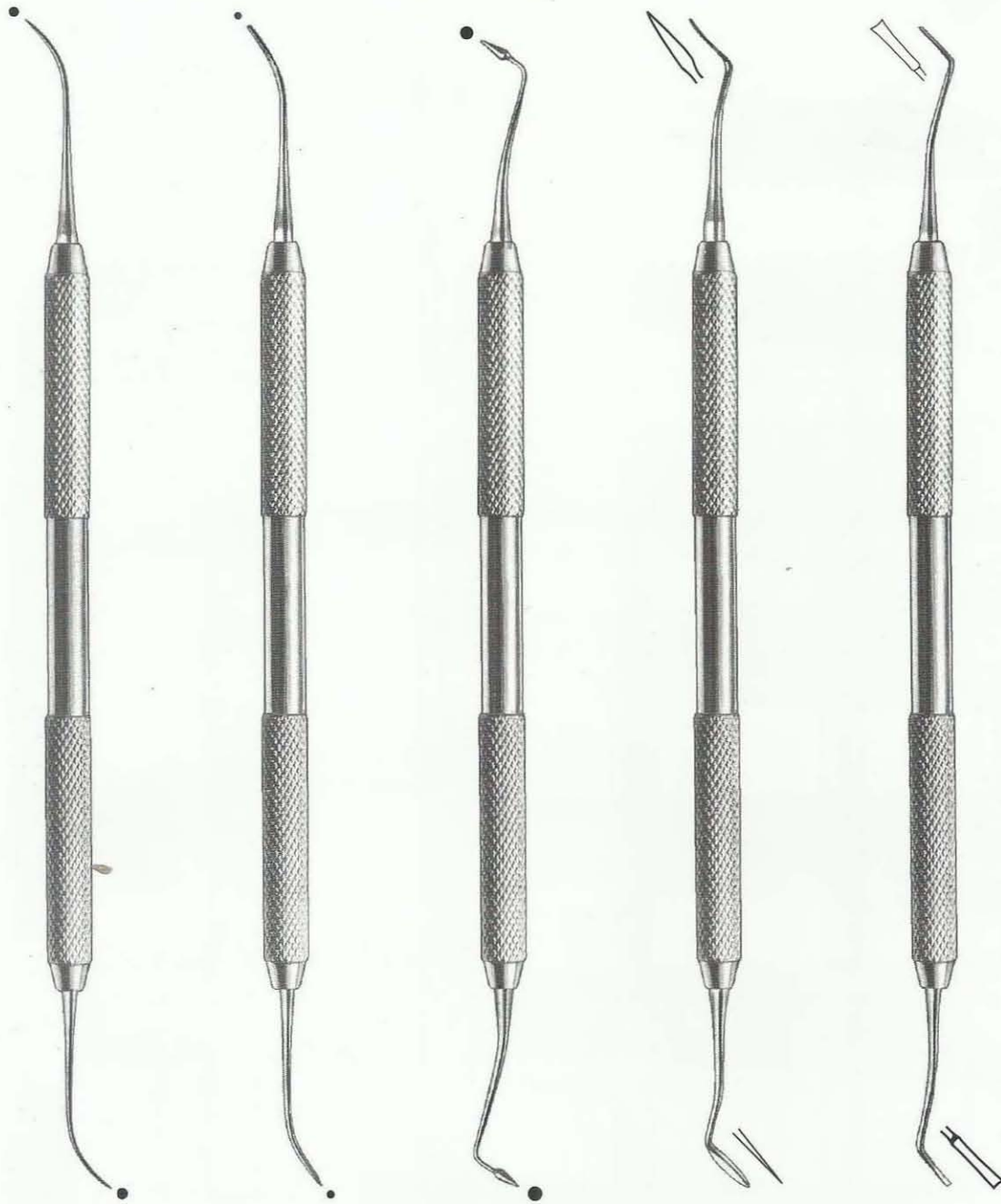

786-2004
Fig.1
P.K. Thomas

786-2005
Fig.2
P.K. Thomas

786-2006
Fig.3
P.K. Thomas

786-2007
Fig.4
P.K. Thomas

786-2008
Fig.5
P.K. Thomas



786-2009
 Fig.1
 Fahnenstock
 cm. 12,5



786-2010
 Fig.1
 Lessmann
 cm. 12,5



786-2011
 Fig.1
 Con Scodellino
 cm. 12,5



786-2012
 Fig.2
 Fahnenstock
 cm. 17



786-2013
 Fig.2
 Lessmann
 cm. 17



786-2014
 Fig.2
 Con Scodellino
 cm. 17



786-2015
cm. 17

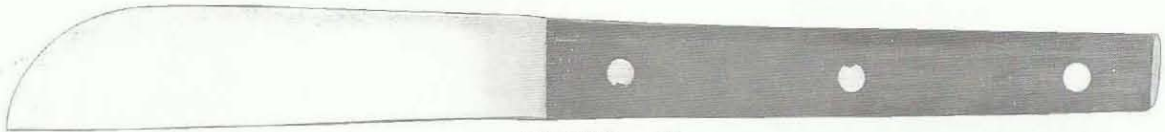

786-2016 cm.17
Gritman



786-2017
cm. 19.5

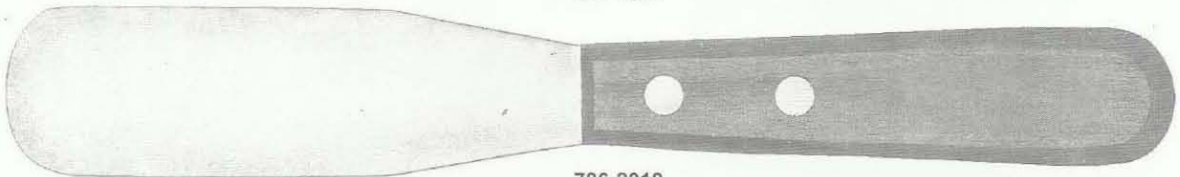

786-2018
cm. 21.5

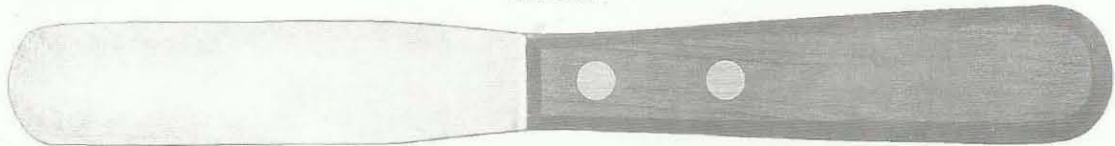

786-2019
cm. 20.5



786-2020
cm. 19.5



786-2021
cm. 20

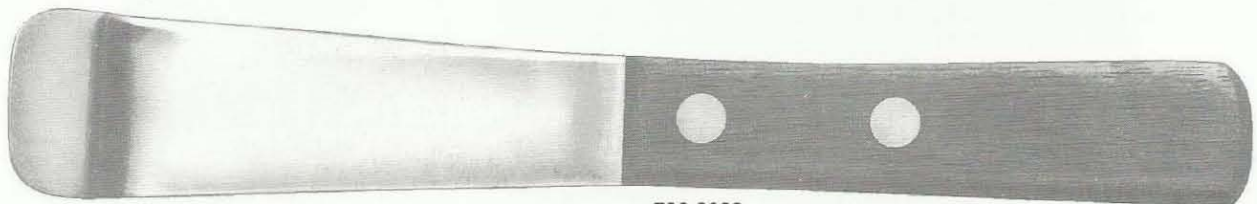

786-2022
cm. 22.5



LAB INSTRUMENTS



786-2023
Saw for Medels



786-2024/BL-1
0.12x5 mm



786-2025/BL-2
0.25x5 mm



786-2026/BL-3
0.25x3 mm



786-2027

Langenbeck
Finger protectors



786-2028



786-2029

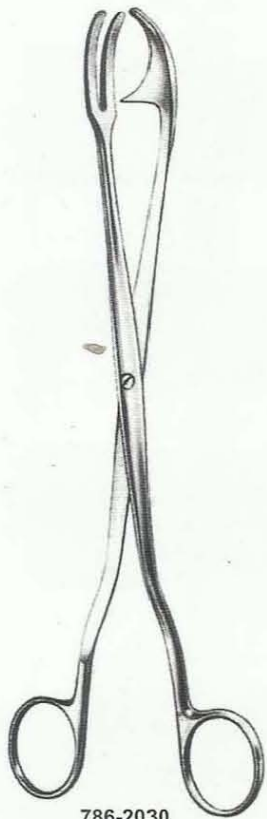

786-2030
Rogge
23 cm

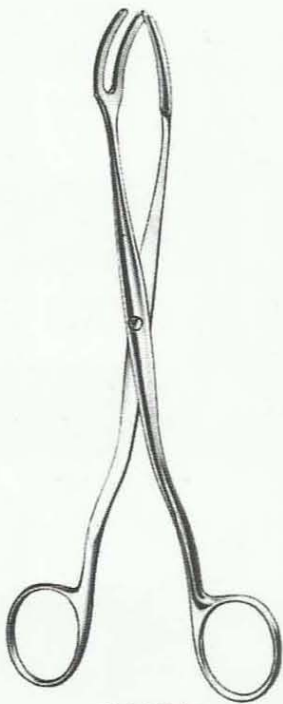

786-2031/1
20 cm

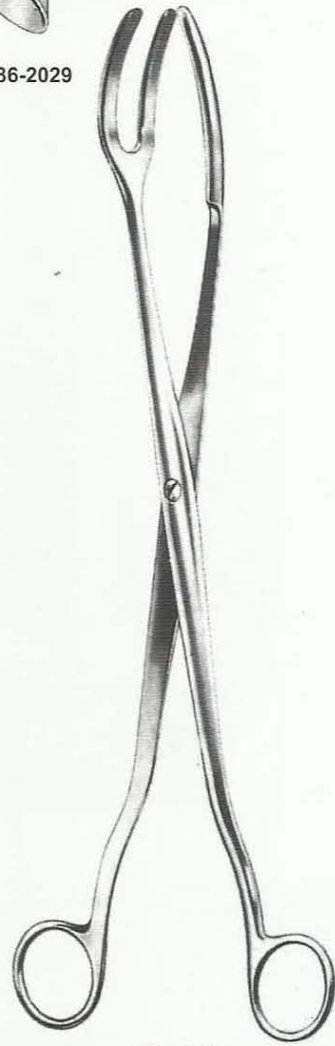

786-2032/2
30 cm

ORTHODONTICS

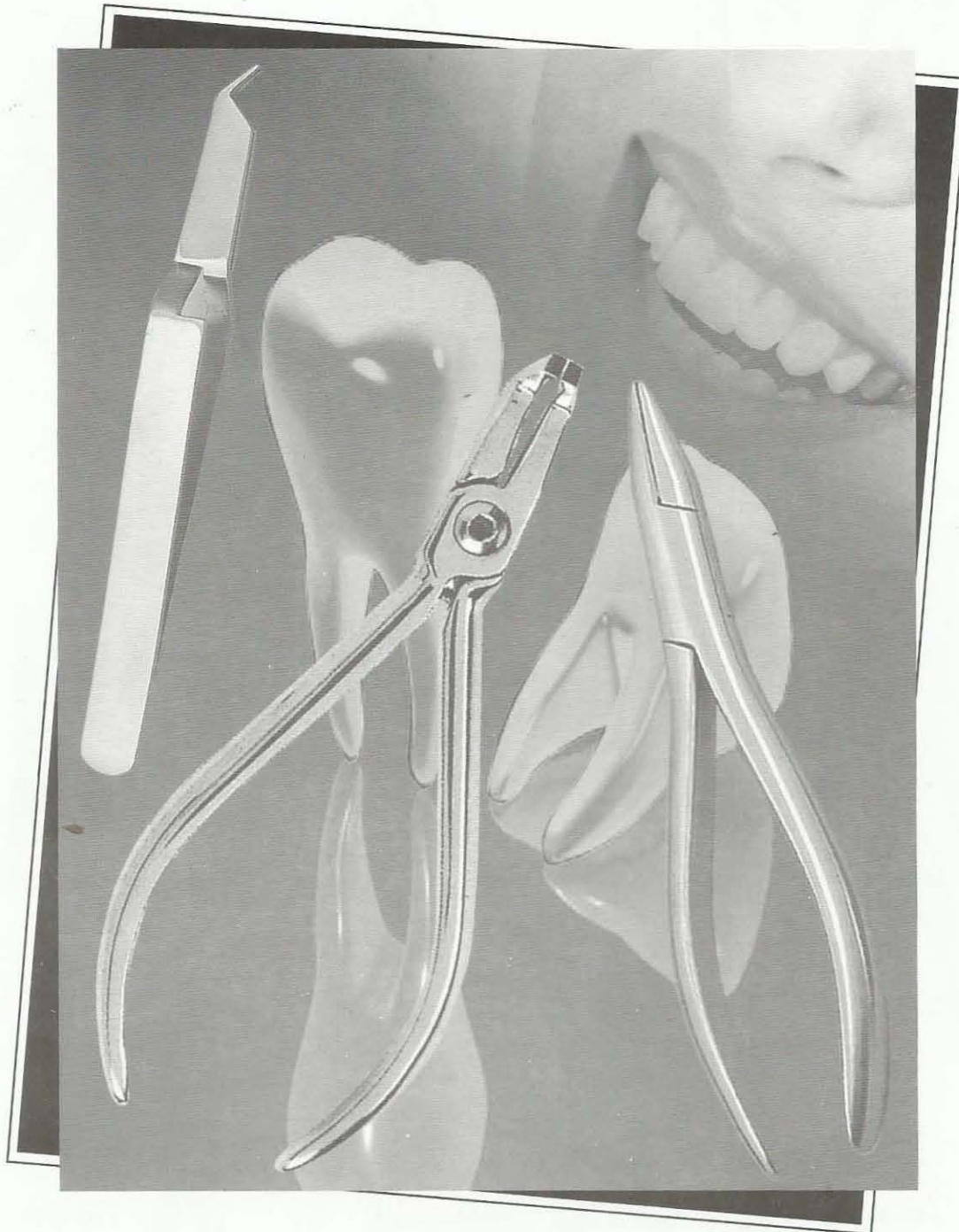

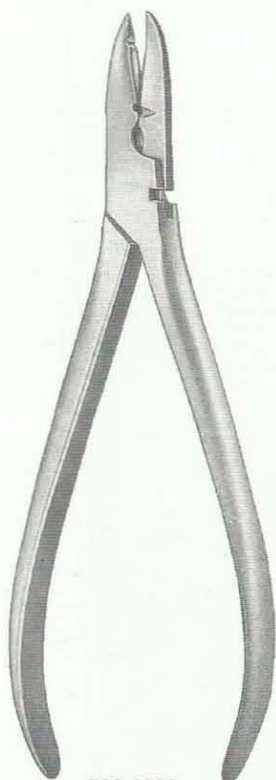

786-2033
 Waldsachs
 15 cm

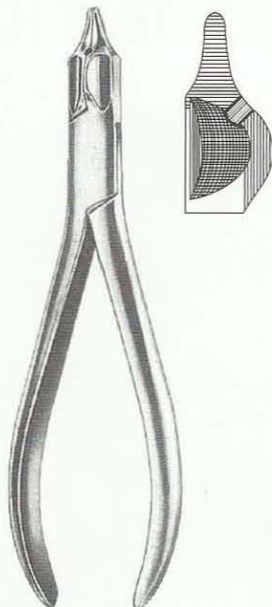

786-2034
 Universal
 16 cm



786-2035
 Nance
 13,5 cm

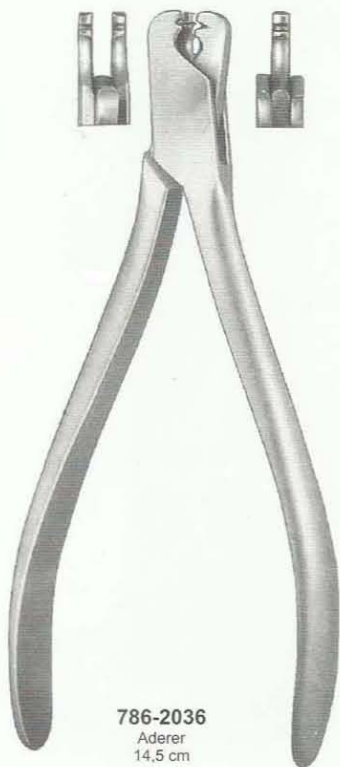

786-2036
 Aderer
 14,5 cm

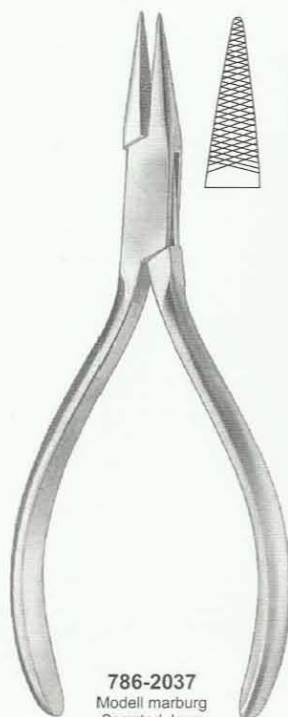

786-2037
 Modell marburg
 Serrated Jaws
 14 cm

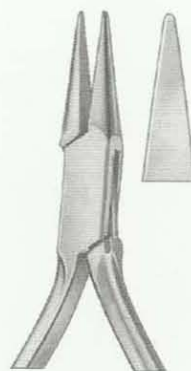

786-2038
 Modell marburg
 Smooth jaws
 14 cm

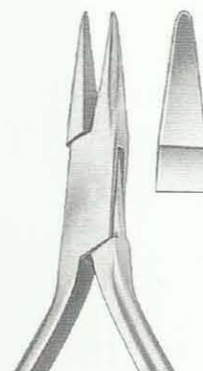

786-2039
 Modell marburg
 Carbide Inserts jaws
 14 cm

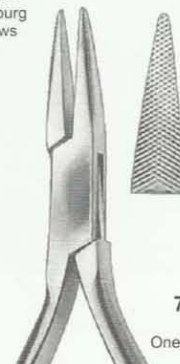

786-2040
 Goslee
 One Serrated Jaws
 14 cm



786-2041
 Aderer
 12 cm



786-2042
 Aderer- Heavy
 12 cm

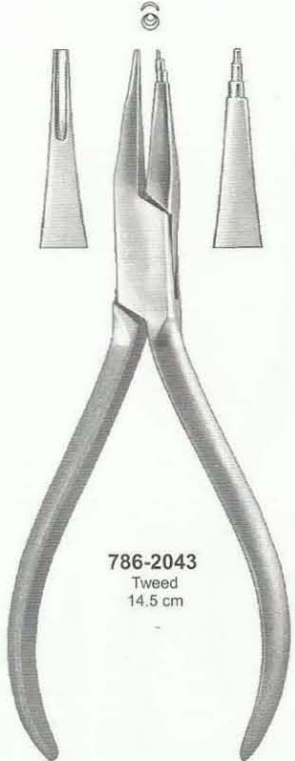

786-2043
 Tweed
 14.5 cm

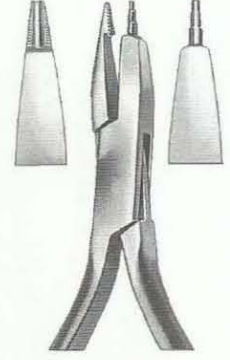

786-2044
 O brien
 13.5 cm



786-2045
 Wire bending pliers
 12.5 cm

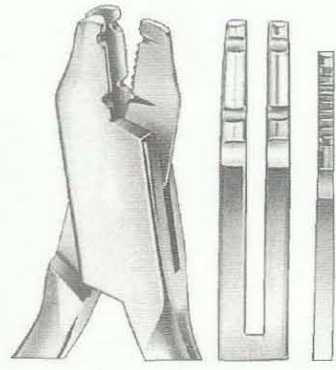

786-2048
 Young
 14 cm

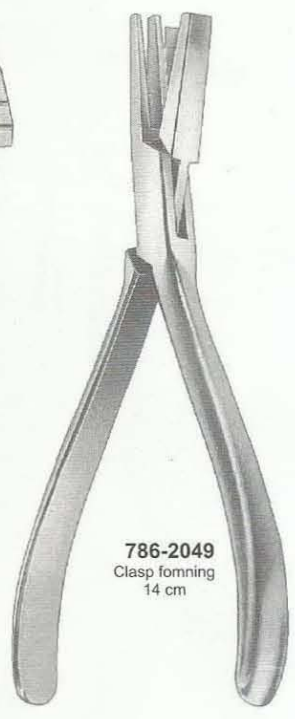
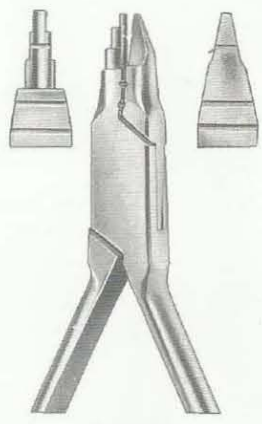

786-2049
 Clasp forming
 14 cm

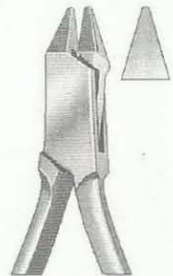

786-2046
 Adams
 12.5 cm



786-2047
 Frevert
 12.5 cm

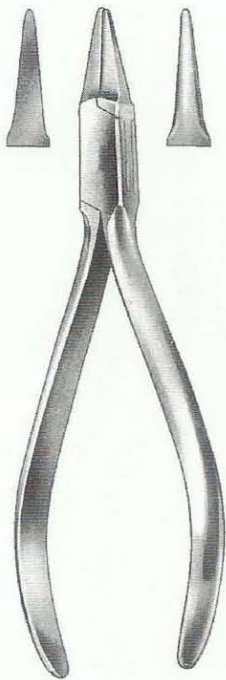

786-2050
 Peeso
 13,5 cm

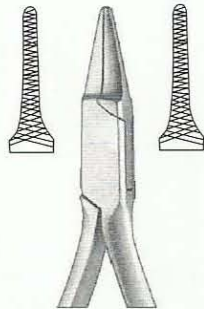

786-2051
 Peeso
 13,5 cm

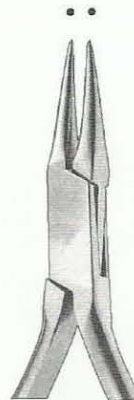

786-2052
 14 cm

Round nose pliers



786-2053
 Langenbeck
 14 cm

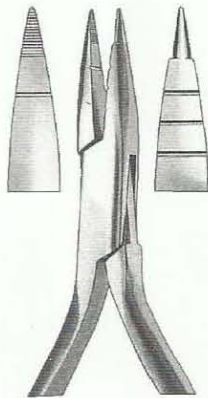

786-2055
 14 cm

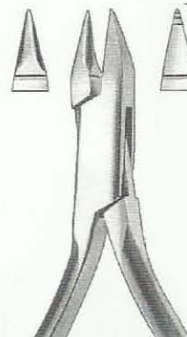

786-2056
 13 cm

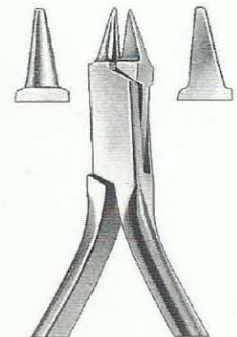

786-2057
 Angle
 12,5 cm

For wire up to

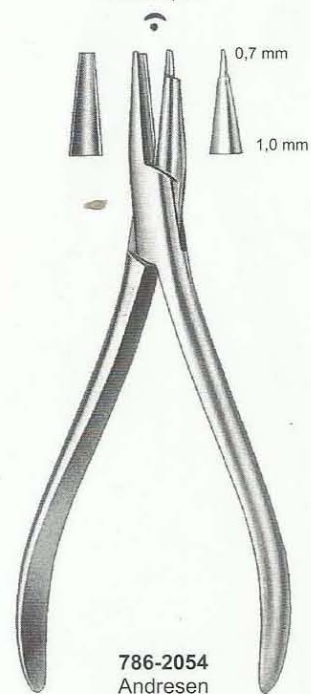

786-2054
 Andresen
 13 cm

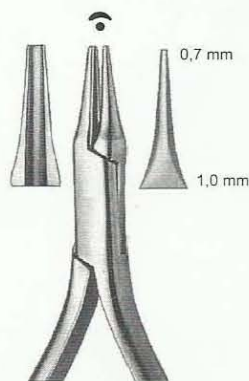

786-2058
 13,5 cm

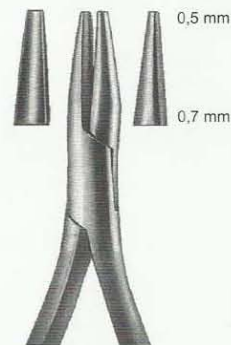

786-2059
 Schwarz
 13,5 cm

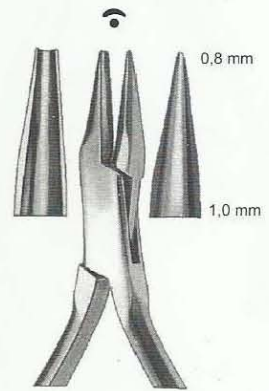

786-2060
 Fischer
 13 cm

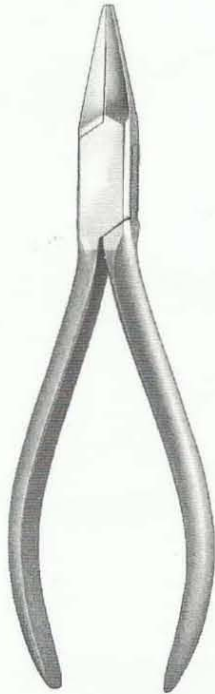

786-2061
14 cm



786-2062
14 cm



786-2063
14 cm



786-2064
14,5 cm



786-2065
14,5 cm



786-2066
14 cm



786-2067
14 cm



786-2068
14 cm

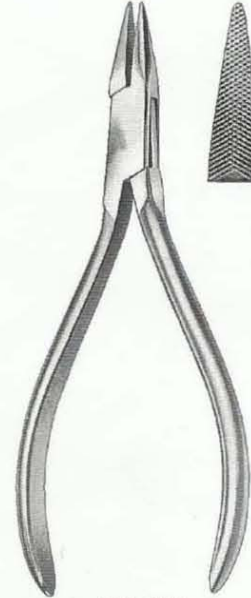

786-2069
Serrated Jaws
12 cm

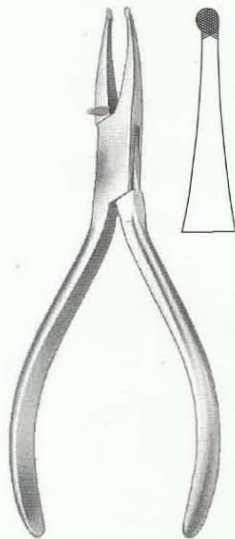

786-2070
How
14,5 cm

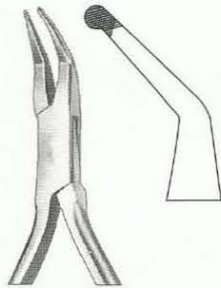

786-2071
How-angled
14,5 cm

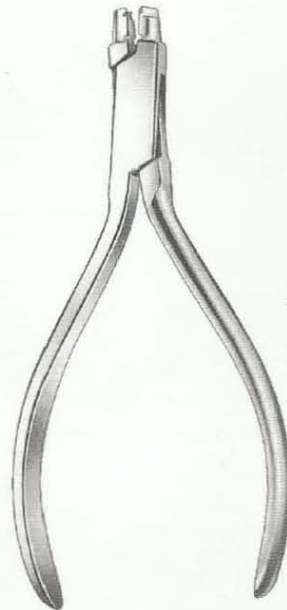

786-2072
Arrow clasp forming
12 cm

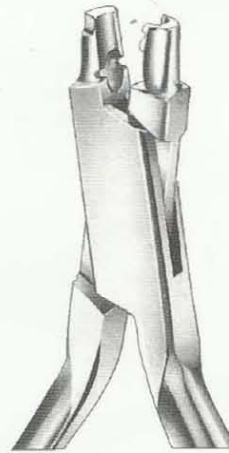

786-2073
Arrow clasp forming
12 cm

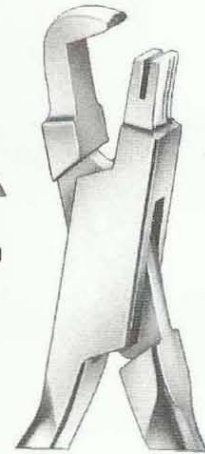

786-2074
Arrow clasp bending
12 cm

Orthodontic Pliers
 Orthodontiezangen
 Alicates para Orthodontie

786-2075

How Plier

Firmly hold the bracket tie wing for seating of the band.
 Carbide serrated tips for non slip grip. 49.50

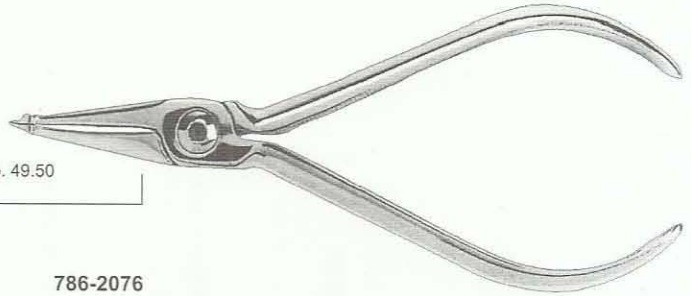

786-2076

De Bonding Plier

Bracket / Adhesive remover with replaceable tool steel tip. Wedge between both edges of the base of the bracket and tooth surface. Easily lifting off the bracket or Bonding material. 49.50

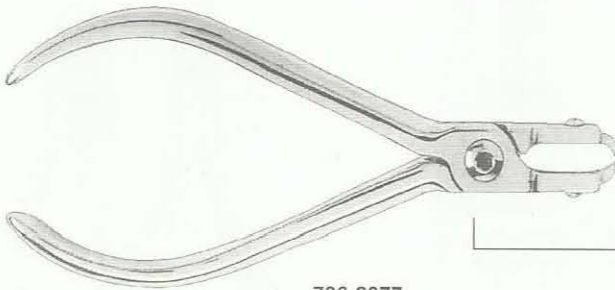

786-2077

Jara Back Plier

A Plier for precise bending of wires. Precision grooves ensure accurate bending and closing of loops. Serrated tip for up to .020" wires. 49.50

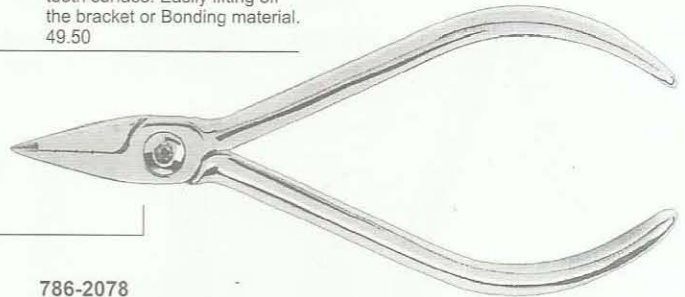

786-2078

Posterior Band Remover Long

The padded tip rest on the Occlusal of the molar and the carbide tipped side removes the bracket or Bonding material. 49.50

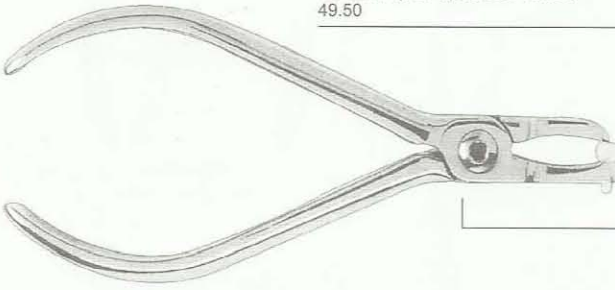

786-2079

Hard Wire Cutter

Cuts hard wire up to .020" carbide insert for longer life. 49.50

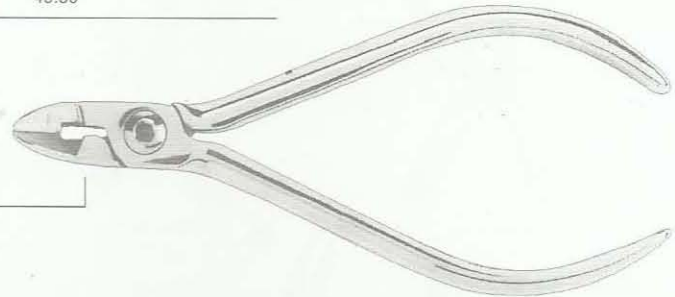

786-2080

Posterior Band Remover Small

49.50

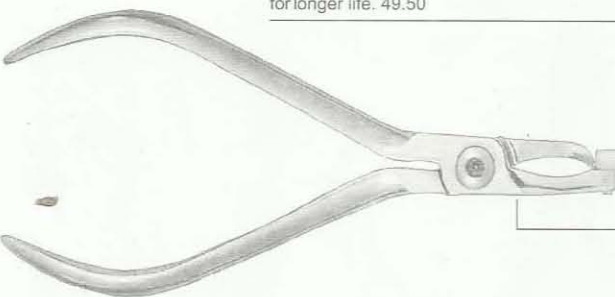

786-2081

Pin & Ligature Cutter

Standard size lips designed to cut soft wire up to .051". 49.50

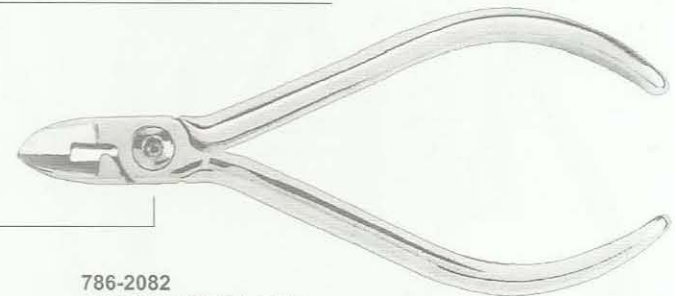

786-2082

Tweed Loop Forming Plier

3 Size carbide tip allows to make 3 size loops. Can hold wire firmly upto .022" x .028". The other side serrated tip gives none slip grip. 49.50

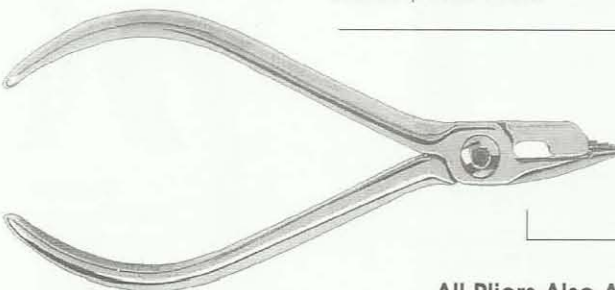

All Pliers Also Available In Box Joint

786-2083

Bird Beak Plier

1/2" Long tip carbide inserted round tip and flat ground tip gives non slip grip for wire up to .030". 49.50

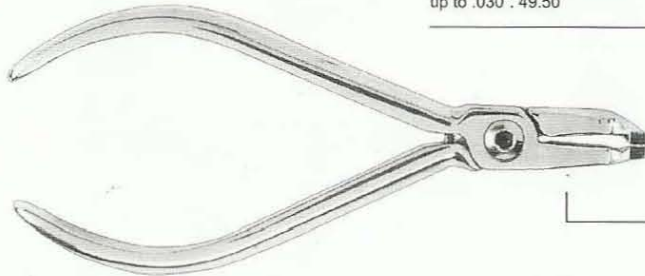
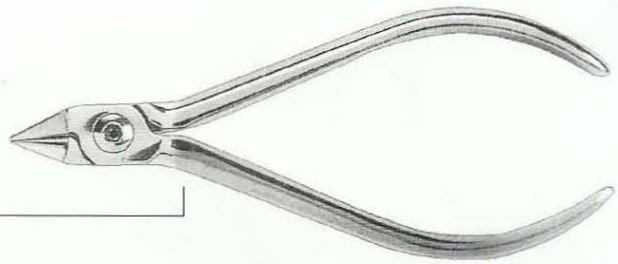

786-2084

Angled Direct Bond Bracket Remover

60° Angled tip allows for easy access to difficult anterior and posterior areas. 49.50

786-2085

Safety hold, small Distal end Cutter

Narrow and light. 49.50

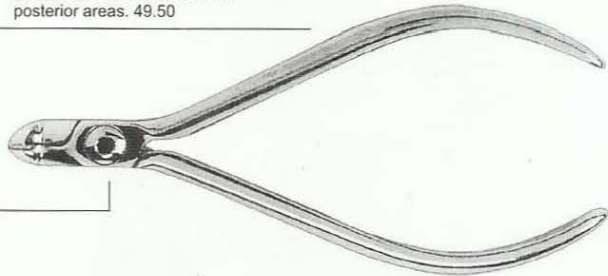

786-2086

Weingart Utility Plier

Matching deep serrated pads holds wire firmly at a convex working angle. Tapered narrow lip fits easily between brackets. 49.50

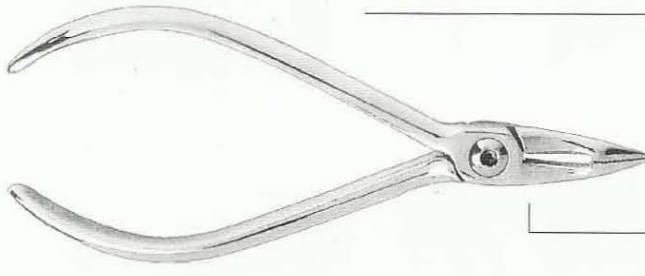

786-2087

Safety hold, Distal end Cutter

Carbide tips for longer life and sharpness cuts and hold wire up to .022" x .028". 49.50

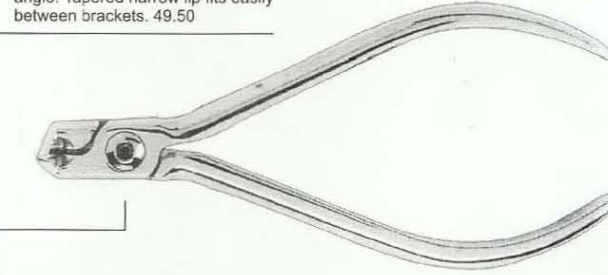

786-2088

Three Prong Clasps Adjusting Plier

Rounded jaws close and adjust clasps without niking wire upto .030". 49.50

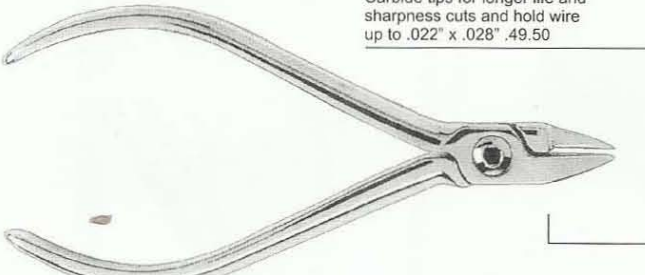

786-2089

Mini Pin & Ligature Cutter

Narrow tips cuts pins, Ligatures and elastic smoothly and soft wire up to .015". 49.50

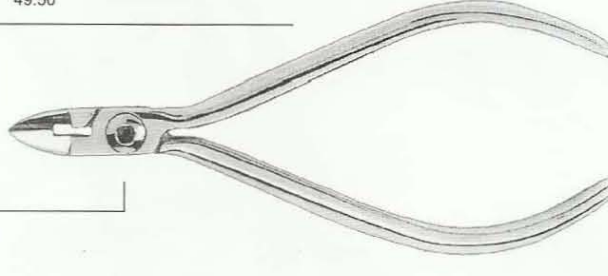

786-2090

Light Wire Plier

Wire forming Plier upto .061" the longer tapered beaks make it easier to bend small diameter loops. 3Groves on square tip. 49.50

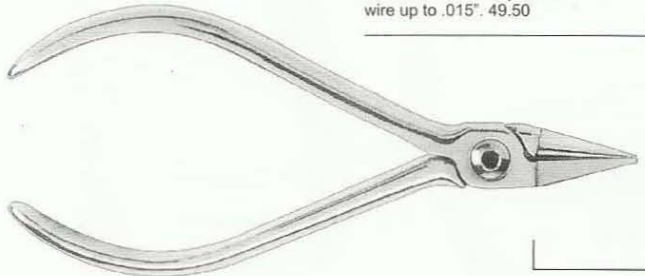

All Pliers Also Available In Box Joint

Orthodontic Pliers
Orthodontiezangen
Alicates para Orthodontie

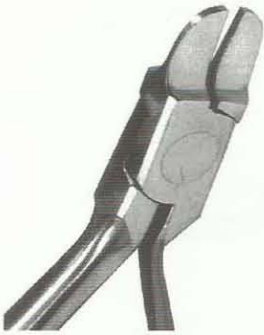

Rectangular Arch plier
13 cm / 5"
786-2091 Box Joint
786-2092 Screw Joint
786-2093 L-Key Joint
Short jaws, Tweed style, for use with square or rectangular wires. Blades parallel at 0.02", 0.51mm opening.

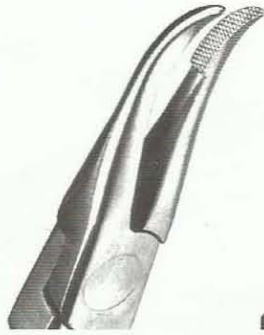

Weingart style plier
13 cm / 5"
786-2094 Box Joint
786-2095 Screw Joint
786-2096 L-Key Joint
Classical design, rounded tips. Useful for removal of ceramics.



Arch contouring plier
13 cm / 5"
786-2097 Box Joint
786-2098 Screw Joint
786-2099 L-Key Joint
for easily forming arches.

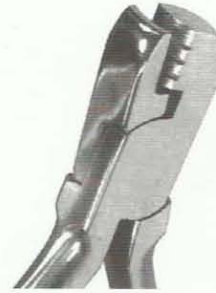

Arch forming & contouring plier
13 cm / 5"
786-2100 Box Joint
786-2101 Screw Joint
786-2102 L-Key Joint
With 3 grooves, For wire 0.016", 0.018" & 0.022".



Arch forming plier
13 cm / 5"
786-2103 Box Joint
786-2104 Screw Joint
786-2105 L-Key Joint
Without grooves

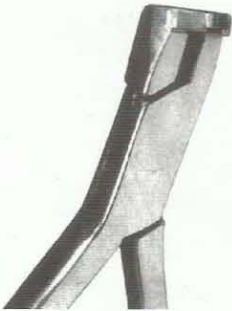

Micro Distal end cutter
13 cm / 5"
786-2106 Box Joint
786-2107 Screw Joint
786-2108 L-Key Joint
With safety hold, cuts arch wires. Cuts rectangular wire up to 0.56x0.71mm, round wire up to 0.51mm and twisted wire up to 0.41mm

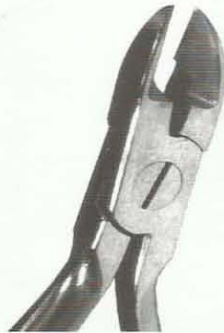

Hard wire cutter
13 cm / 5"
786-2109 Box Joint
786-2110 Screw Joint
786-2111 L-Key Joint
For cutting orthodontic wires for fixed techniques any size. Cuts rectangular wire up to 0.56x0.71mm and round wire up to 0.51mm

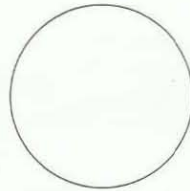

Distal wire cutter
15 cm / 5"
786-2118 Box Joint
786-2119 Screw Joint
786-2120 L-Key Joint

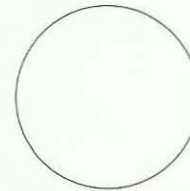

Lindblom
13 cm / 5"
786-2121 Box Joint
786-2122 Screw Joint
786-2123 L-Key Joint



45° Ligature cutter
13 cm / 5"
786-2112 Box Joint
786-2113 Screw Joint
786-2114 L-Key Joint
45° angled for easy access to posterior areas. Cuts ligature wire up to 0.36mm

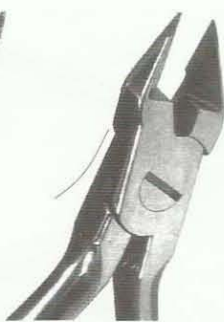

Miniature ligature cutter
13 cm / 5"
786-2115 Box Joint
786-2116 Screw Joint
786-2117 L-Key Joint
For soft wires. ligature wire up to 0.014" (0.36mm)



786-2124
 Band seating
 &
 removing instruments

786-2125

786-2126

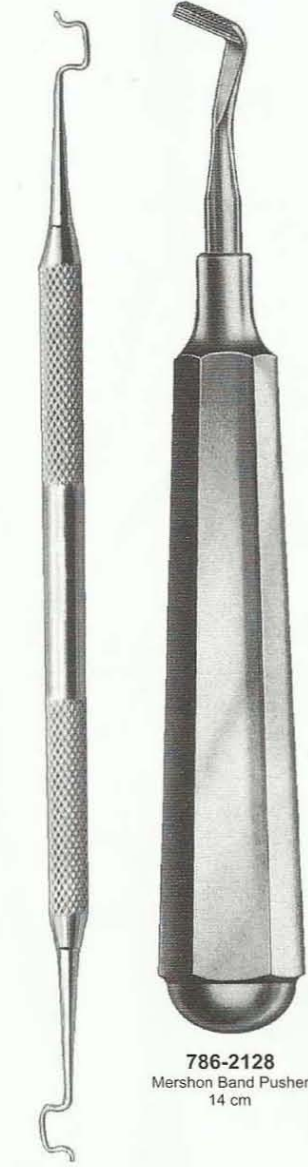

786-2127
 Elastic Instruments



786-2128
 Mershon Band Pusher
 14 cm



786-2129
 Band Setter with
 tin insert
 15 cm



786-2130
 13.5 cm



786-2131
 14 cm

Bracket holding tweezer

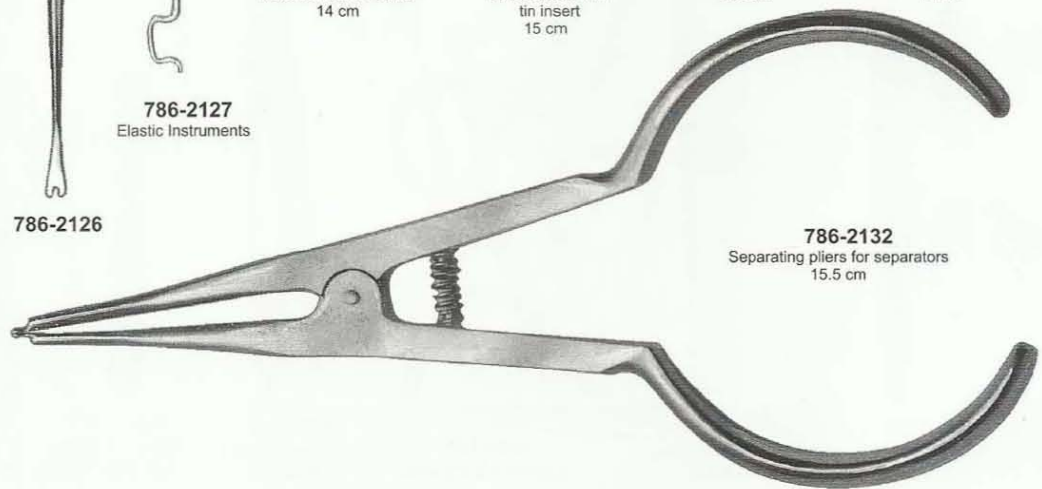

786-2132
 Separating pliers for separators
 15.5 cm

ORTHODONTIC INSTRUMENTS

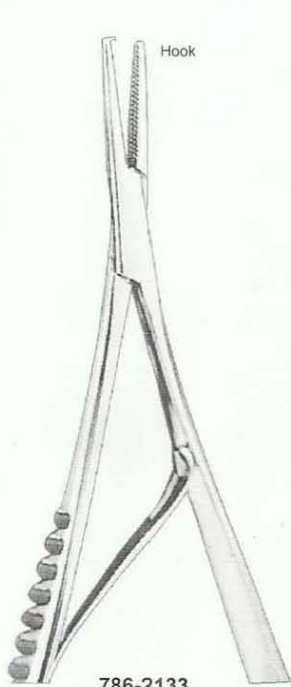

786-2133
 Mathieu pliers
 14 cm

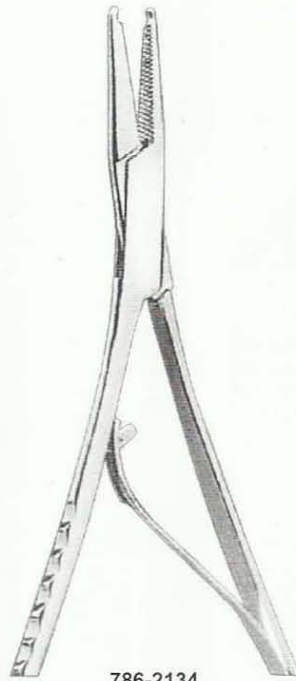

786-2134
 Elastic ligature placing pliers
 14 cm



786-2135
 Mathieu ligating pliers
 14 cm



786-2136
 Mathieu plier
 with finger ring
 14 cm

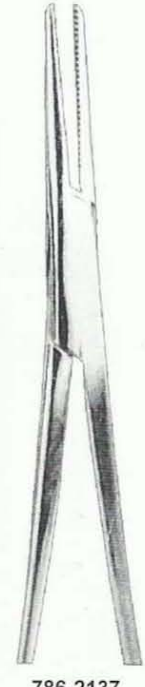

786-2137
 Mosquito plier



786-2139
 Bracket placing
 tweezers



786-2140
 Bracket placing
 tweezers

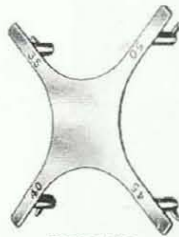

786-2138
 Bracket positioning gauge

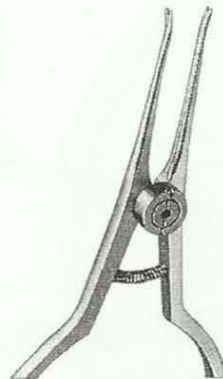

786-2141
 Ligature tying plier



786-2142
 Bracket holding
 tweezers



786-2143
 Band seating
 instrument



786-2144
 Mosquito forceps

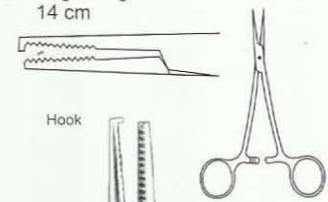

TUNGSTEN CARBIDE INSTRUMENTS

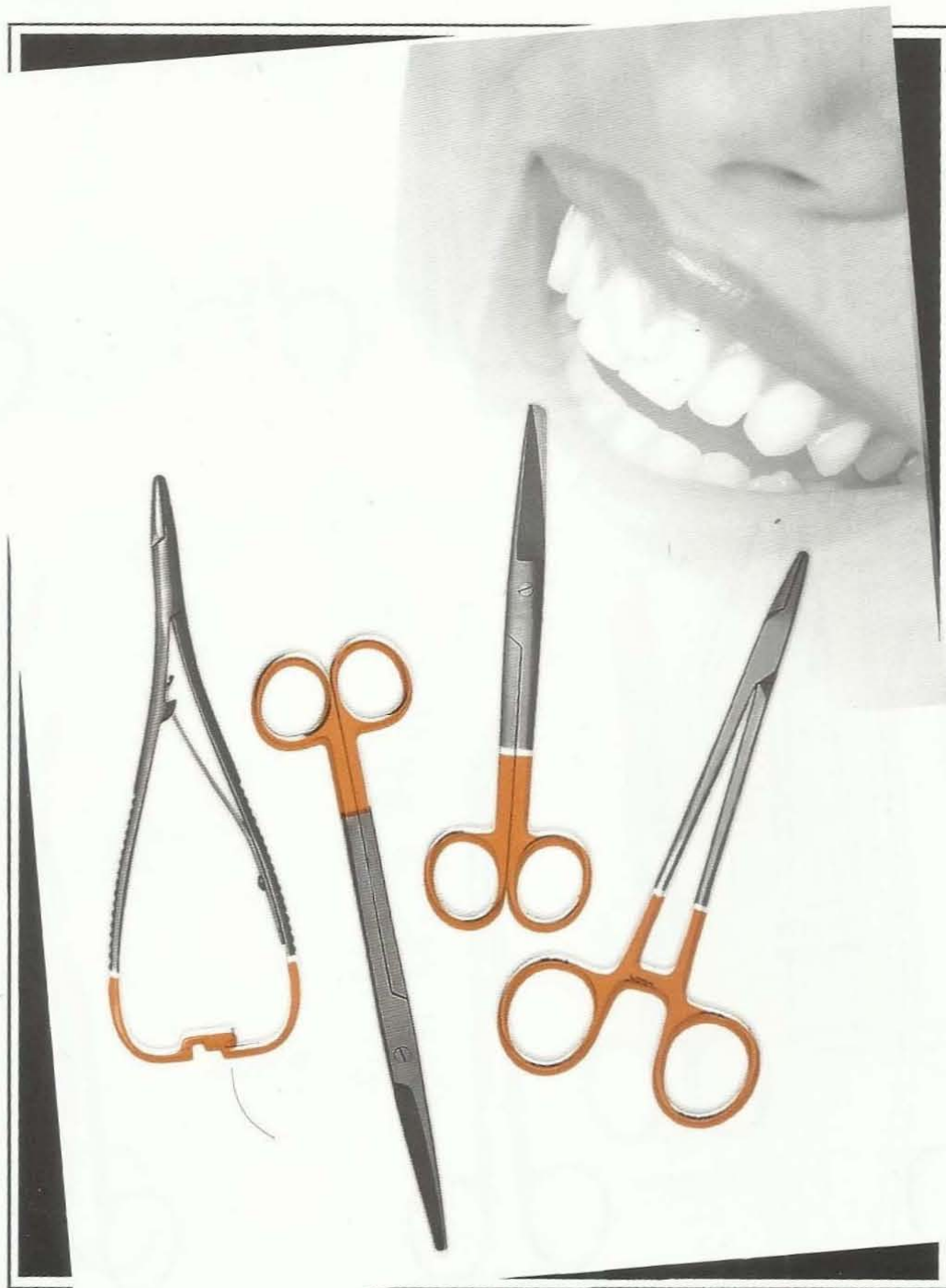

Scissors with Tungsten Carbide Inserts
 Scheren mit Hartmetalleinsätzen
 Tijeras con Filos de Carburo de Tungsteno

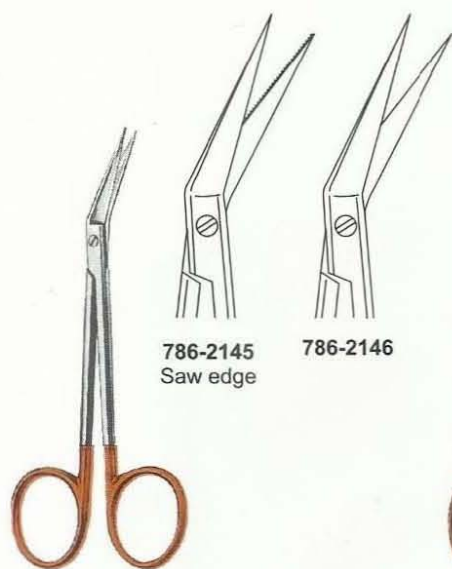

786-2145
Saw edge

786-2146

Gum Scissors TC
13 cm / 5"
Angular



786-2147
Straight

Gum Scissors TC
11.5 cm / 4½"

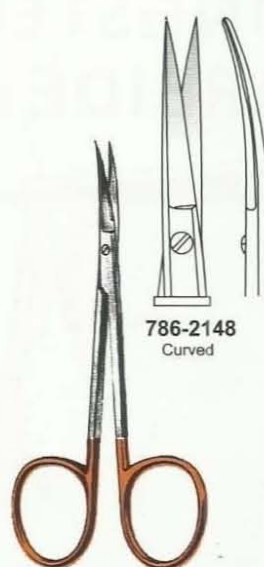

786-2148
Curved

Gum Scissors TC
11.5 cm / 4½"



786-2149

Gum Scissors TC
11.5 cm / 4½"



786-2150
Saw edge

Dean TC
17 cm / 6¾"



786-2151
Saw edge

Locklin TC
16 cm / 6¼"



786-2152
Saw edge

Locklin TC
16 cm / 6¼"

Also available in German Forging

Scissors with Tungsten Carbide Inserts
 Scheren mit Hartmetalleinsätzen
 Tijeras con Filos de Carburo de Tungsteno

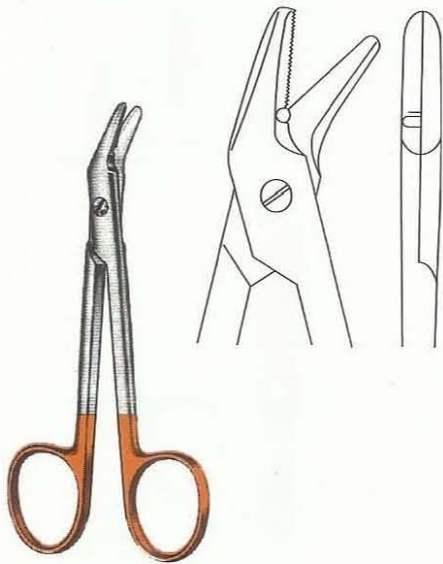

Universa TC
 786-2153
 12 cm / 5"

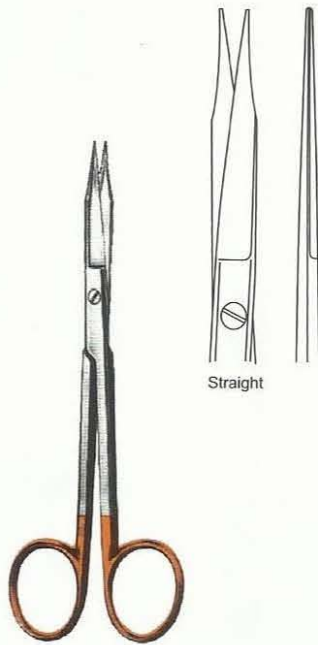

Goldman-Fox TC
 786-2154
 13 cm / 5"

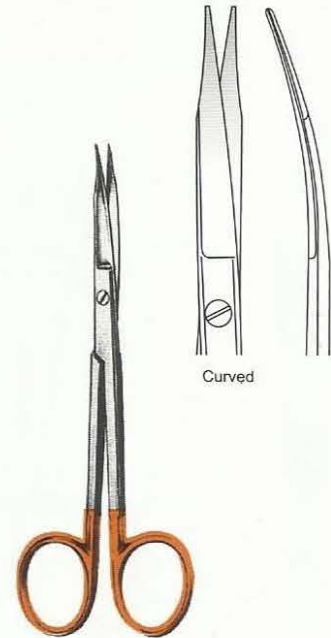

Goldman-Fox TC
 786-2155
 13 cm / 5"

Goldman-Fox TC
 (special)
 786-2156
 13 cm / 5"

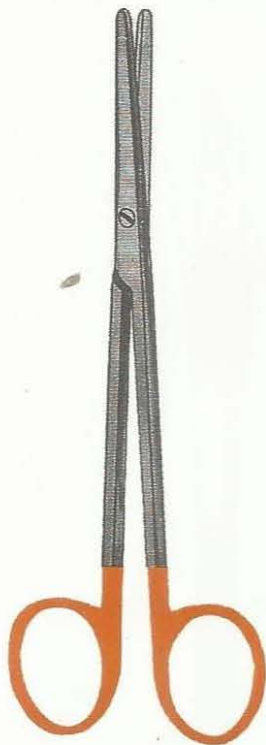

Metzenbaum TC
 786-2157 14cm Str
 786-2158 18cm Str
 786-2159 20cm Str
 786-2160 23cm Str



786-2161 14cm Cur
 786-2162 18cm Cur
 786-2163 20cm Cur
 786-2164 23cm Cur

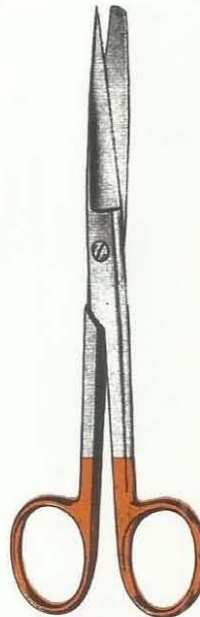

Standard TC

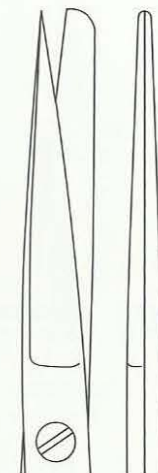

786-2165
 Straight

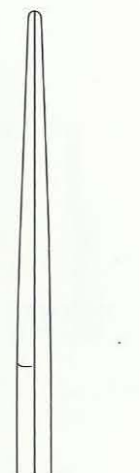

14.5 cm / 5 1/4"
 16 cm / 6 1/4"
 18 cm / 7"



786-2166
 Curved

Also available in German Forging

Dressing & Tissue Forceps
 Pinzetten
 Pinzas De Diseccion



Adson TC

- 

786-2167
12 cm / 4 1/2"
- 

786-2169
12 cm / 4 1/2"
- 

786-2168
15 cm / 6"
- 

786-2170
15 cm / 6"





Potts-Smith TC

- 

786-2171
15 cm / 6"
- 

786-2173
18 cm / 7"
- 

786-2172
20 cm / 8"
- 

786-2174
23 cm / 9"
- 

786-2175
25 cm / 10"



TC

- 

786-2176
14.5 cm / 5 1/2"
- 

786-2177
18 cm / 7"



De Baakey TC

- 

786-2178
15 cm / 6"
- 

786-2179
19 cm / 7 1/2"
- 

786-2180
24 cm / 9 1/2"

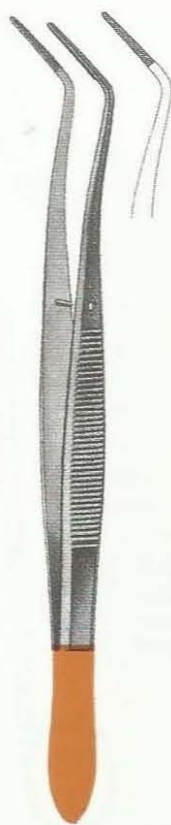

Meriam TC
 786-2181
 16 cm

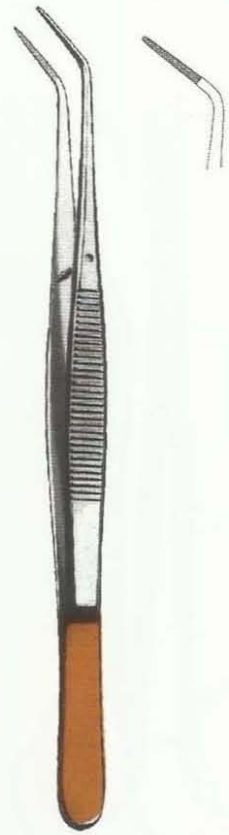

London College TC
 786-2182
 Fig.2
 15 cm



Derf TC
 786-2183
 12 cm / 4 3/4"



Webster TC
 786-2184
 12 cm / 4 3/4"



786-2185
 Plain

786-2186
 Serrated

Halsey TC
 13 cm / 5"

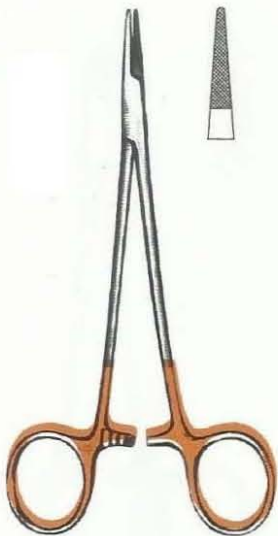

Micro-Vascula TC
 786-2187
 15 cm / 6"



MAYO-HEGER TC

786-2188
 (13cm)

786-2189
 (16cm)

786-2190
 (18cm)

786-2191
 (20cm)

786-2192
 (23cm)

786-2193
 (26cm)

786-2194
 (30cm)

Also available in German Forging



Crile-Wood TC
786-2195
 15 cm / 6"
 18 cm / 7"
 20 cm / 8"



786-2196
 15 cm / 6"



Gillies TC
 16 cm / 6¼"
786-2197

Mini Gillies TC
 10 cm / 4"
786-2198

Also available in German Forging



Olsen-Hegar TC



786-2203
 12.5 cm / 5"



786-2204
 15.5 cm / 6"



MATHIEU TC



786-2205
(14cm)



786-2206
(17cm)



786-2207
(20cm)



MATHIEU TC STANDARD



786-2208
14 cm / 5½"



786-2209
17 cm / 6¾"



786-2210
20 cm / 8"

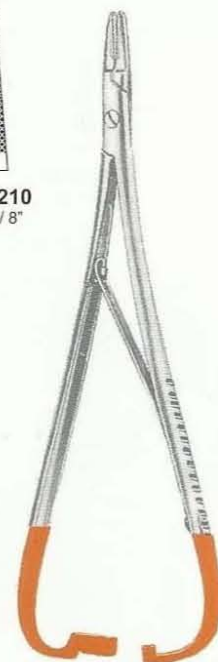

RYDER-LICHTENBERG TC



786-2211
(14cm)



786-2212
(17cm)



786-2213
(20cm)

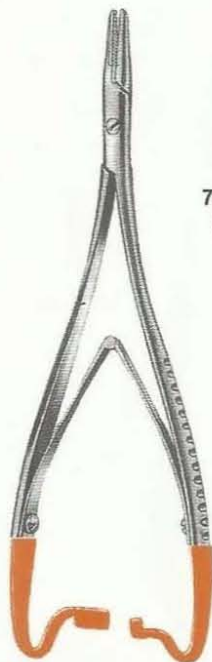

MATHIEU - GRAZIL TC



786-2214
(17cm)

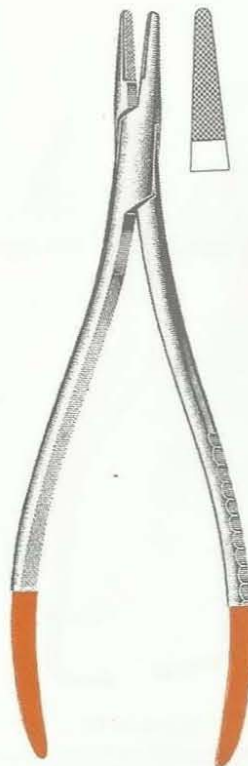

LANGENBACK, KRAFTIG TC
786-2215
(20cm)

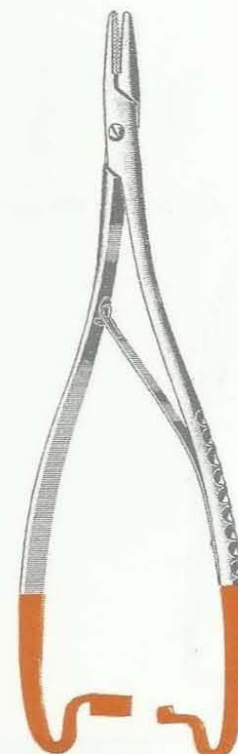

MATHIEU TC



786-2216
(17cm)



786-2217
(20cm)



786-2218
(23cm)

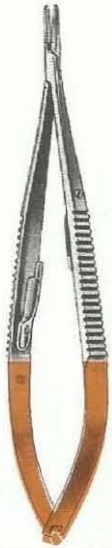

Castroviejo TC
14 cm



786-2219
14 cm / 5½"



786-2221
14 cm / 5½"



786-2220
14 cm / 5½"



786-2222
14 cm / 5½"



Castroviejo Barraquer TC
786-2223
12 cm / 4¾"



Castroviejo TC
786-2224
13 cm / 5"

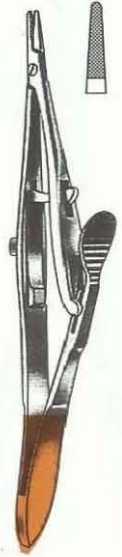

Kalt
786-2225 TC
13 cm / 5¼"
Standard model
Delicate jaws

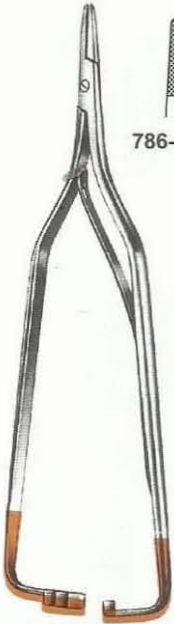

Arruga TC
16 cm / 6¼"



786-2226



786-2227



786-2228



786-2229

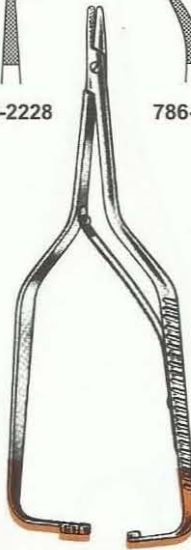

Boynton TC
12.5 cm / 5"
Delicate



786-2230
Smooth
(str)



786-2231
Smooth
(cur)



786-2232
(str)



786-2233
(cur)

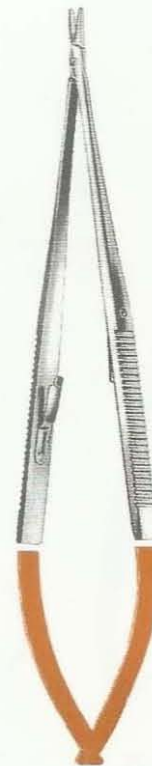

CASTROVIEJO TC
(18cm)

HANDLES REFERENCE GUIDE

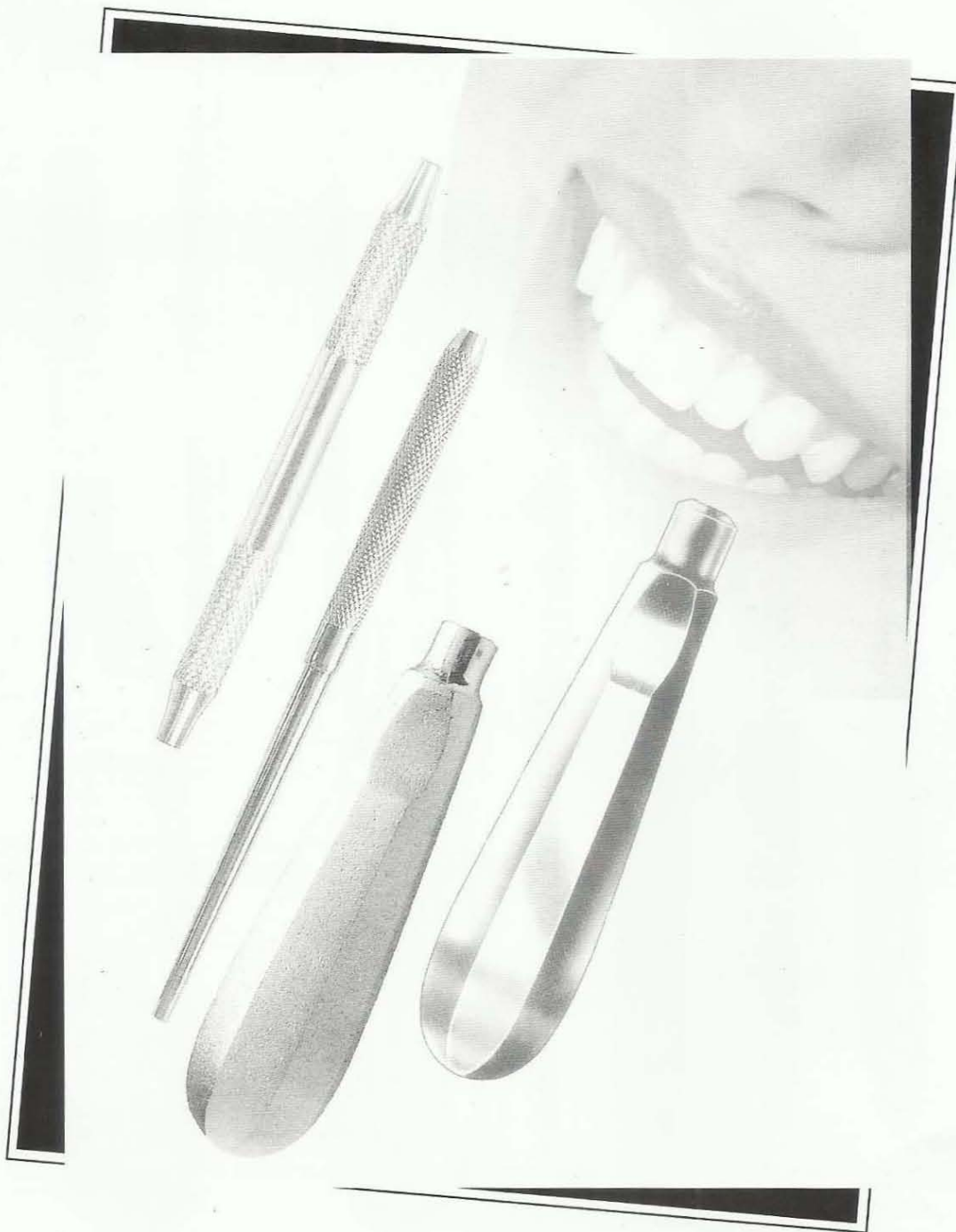

HANDLES REFERENCE GUIDE

786-2234
A TO K

Ø 6mm



A
Single ended
Knurling round

Ø 6mm



B
Double ended
knurling round

Ø5.5mm



C
Single ended
octangle
serrated

Ø5.5mm



D
Double ended
octangle
serrated

Ø 8mm



E
Single ended
hollow round

Ø 8mm



F
Double ended
hollow round

Ø 8mm



G
Double ended
hollow round
grooved

Ø5.5mm



H
Double ended
Swiss pattern
octangle

Ø 8mm



I
Double ended
Knurling Octagonal

Ø9.25 mm



J
Double ended
Hollow Round Grooved



K
Ø8 mm Double ended
Hollow round plain grooved

Note:

If you have preference different from the standard handle shown, please specify the optional handle number when ordering. If the tip/handle combination you desire is not shown, we will be glade to provide you with a quote for its preparation.

HANDLES REFERENCE GUIDE



Note:

If you have preference different from the standard handle shown, please specify the optional handle number when ordering. If the tip/handle combination you desire is not shown, we will be glade to provide you with a quote for its preparation.

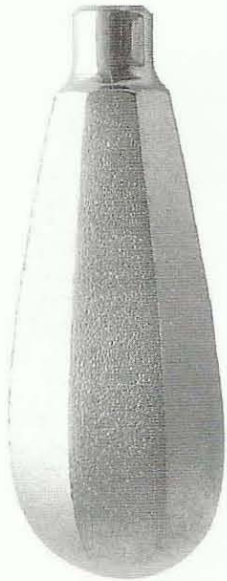

L
Shot Blast Finishing
For Elevators

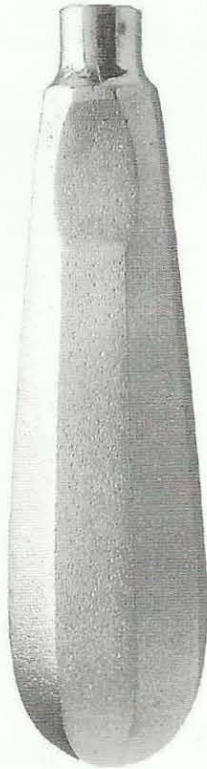

M
Shot Blast Finishing
For Elevators



N
Apexo
Stainless steel handle
For Elevators

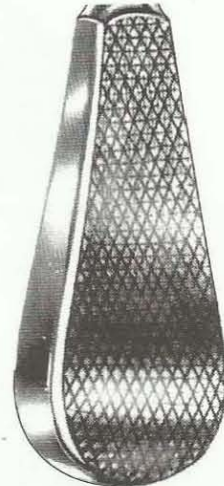

O
Coleman
For Elevators

786-2235
L TO S

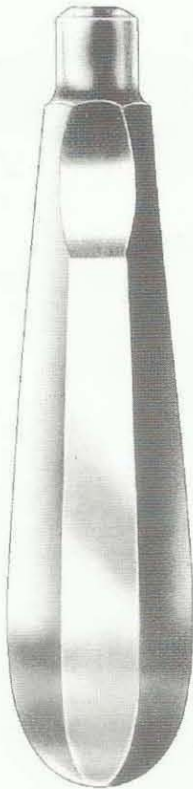

P
Hylin
Stainless steel
handle
For Elevators

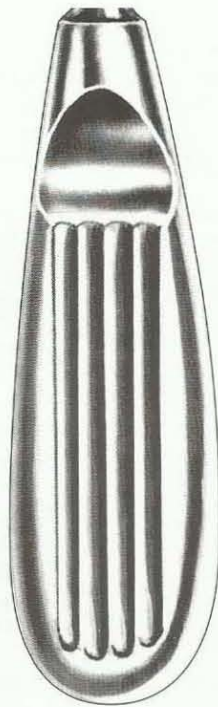

Q
Hylin
Stainless steel
handle
For Elevators



R
Stainless steel
handle
For Elevators



S
Stainless steel
handle
For Elevators

ALPHA BETICAL INDEX

A

Aluminum Trays	151
Amalgam Carriers	102
Amalgam Carves	120
Amalgam Well	102
Articulating paper Forceps	128
Articulators	162

B

Blades For Saw	170
Boley Gauge	126
Bone Chisels	131-32-34
Bone Compactors	27
Bone Crushers	22,23
Bone Curettes	135,136,141
Bone Files	137,140
Bone Injector	23
Bone Mallet	22
Bone Cutters	21
Bone Ronguers	19-20-22
Bone Well	23
Burnishers	117

C

Cotton Pliers	88,89,90
Crown Instruments	125,126
Cement Spatulas	103
Crown Removers	125
Crown Scissors	126
Crown Spreaders	126,127
Chisels	131,132,134
Cheek and Lip Retractors,	17
Casette Trays	149
Cotton Forceps	11

D

Dressing Forceps	88,89,90
Dressing Forceps TC	184
Debakey Forceps TC	184

E

Extracting Forceps Eng. Pattern	26 To 48
Extracting Forceps Children Eng. Pattern	49,50
Extraction Tweezers	50
Extracting Forceps American Pattern	52 To 64
Extracting Forceps With Fitting Handle	65 To 72
Extracting Forceps Unique Pattern	73
Explorers	95
Excavators	122,123,124

F

Filling Instruments	104 To 117
Finger Protector	170

G

Gum Scissors	03,04,05
Gingival Margin Trimmers	121
Gingivectomy Knives	142
Gouges	131,132,134
Gracey Curettes	144
Gum Scissors TC	182,183

H

Heamostatic Forceps	10
Handles References Guide	190,191

I

Impression Trays Stainless Steel	153 To 160
Instrument Trays	150
Iwanson Callipers	126

L

Luxating Elevator	74
-------------------	----

M

Mallets	134
Matrix Retainers	129
Mouth Gags	12,13
Mouth Mirrors	97
Mouth Mirrors Handles	97

N

Needle Holder	07,08
Needle Holder TC	185 To 188

O

Orthodontic Instruments	172 To 180
Orthodontic Pliers	172 To 178
Ostetomes	24,25

P

Periodental Pocket Probe	94
Periodontic instruments	139 To 147
Periosteal Elevators	138
Periosteal Elevators (Implants)	22
Periotomes	24
PK. Thomas Set	167
Plaster Cutting Pliers	128
Plaster Knives	169
Pliers	172 To 178
Probes	91,92,93

R

Rubber Dam Clamps	99
Raspators	138
Retractors	12 To 15
Root Elevators	74 To 86
Root Splinter Forceps	51
Rubber Dam Clamp Forceps	100
Rubber Dam Punch	100

S

Saw	
Scalers	
Scalpel Handles	
Sinus Lift Instruments	
Spatulas	
Sponge Forceps	
Sterilizing Forceps	
Surgical Scissors	
Syringes	

T

Tweezers	
Toungue Forceps	
Toungue Depressors	
Tissue Forceps TC	
Tissue Forceps	

U

Universal Scissors	
Universal Scissors TC	

W

Wax Modelling Craves	
Wax Knives	

PAK K.T.S. INTERNATIONAL

St.no. 3 Faizabad Pacca Garrah Sialkot Pakistan

Tel/fax: 92-52-4265218 E-mail: Info@pakkts.com Web: www.pakkts.com



CE

FDA



TAJMIR : 0092 300 9619551